

Lindstad, E., Alterskjær, A., Sandaas, I., Solheim, A., Vigsnes, J., T., 2017 *Open Hatch Carriers – Future Vessel Designs & Operations*. Transactions - Volume 125, page 39 - 56

THE SOCIETY OF NAVAL ARCHITECTS AND MARINE ENGINEERS

TRANSACTIONS Volume 125, 2017



TRANSACTIONS Volume 125 was published in 2022 by SNAME and reports the activities of the Society in 2017 and a selection of papers presented at the Society's events in 2017 based on three criteria: Archival, Significant or Award-winning papers

This paper was first presented at SNAME Maritime Convention (SMC-2017) in Houston Texas in October 2017. It was there after selected for publication in the 2017 Transactions by the Society's Annual Meeting Paper Committee. The purpose of this front page is for any potential reader to familiarize themselves with the SNAME context and suggested how to quote the paper, including the ISSN and the ISBN references. Compared to the original submitted paper the page numbers are corrected to reflect the page numbers in Transactions 125. Compared to the printed version in Transactions 125 the main difference is that figures here are printed in colours

ISSN 0081 1661 ISBN: 978-0-9996362-0-6 (Hard cover) ; 978-0-9996362-1-3 (Soft cover)

Open Hatch Carriers - Future Vessel Designs & Operations

Elizabeth Lindstad ¹(F), Anders Alterskjær ¹(V) Inge Sandaas ²(V), Astrid Solheim ³(V), Joakim Tveiten Vigsnes ³(V)

¹Sintef Ocean AS (MARINTEK), Trondheim, Norway

²Naval Architect, Grimstad, Norway

³Norwegian University of Science and Technology (NTNU), Trondheim, Norway

Email: Lindstad@.sintef.no

The development of Open hatch carriers (OHC) dates back to the early 1960s linked to transport of newsprint from the paper mills along the coast of British Columbia (Canada) to the news-printers in San Francisco and Los Angeles (USA). Prior to that, conventional general cargo ships, tween-deck liners and trampers transported newsprint and lumber (timber). The present OHC fleet transport a wide range of commodities in addition to the initial newsprint, i.e. timber (lumber), fertilizer (both as bulk and in bags), minor bulk, containers, project cargoes and even road units on multi decks. This implies that the present OHC fleet are competing with dry bulkers for typical dry bulk cargoes, and with container vessels and Ro-Ro's for cargo types, which requires more careful handling. The paper presents an overview of the historic development of transport efficiencies from the steam ships used in newsprint and timber trades in the early 1900 up to the latest generation of OHC's. Followed by a parametric feasibility study focusing on identifying cost and improvement potentials for new alternative designs versus the present. The results indicates that alternative combinations of main measurements to enable lower block coefficients reduces fuel consumption and greenhouse gas emissions (GHG) per freight unit transported. Moreover, these designs might increase the competitiveness of Open Hatch vessels versus their competitors, i.e. dry-bulk, container and Ro-Ro.

Keywords: Ship Design; Energy efficiency; Forest Products
General cargo; IMO; World Trade.

INTRODUCTION

From the first days of human civilization, sea transport has dominated trades between cities, nations, regions, and continents. Together with telecommunication, trade liberalization and international standardization, transport and maritime transport in particular has enabled the process we call globalization (Kumar and Hoffman, 2002). World trade in the form we know today started around 1850 as global communication developed with steam engines allowing vessels to move without wind, steel hulls enabling larger ships, screw propellers making ship more seaworthy and deep-sea cables allowing traders and ship owners to communicate across the world (Stopford, 2009).

The development of Open hatch carriers (OHC) dates back to the early 1960s (Stokseth, 1992) and was linked to transport of newsprint from the paper mills along the coast of British Columbia (Canada) to the news-printers in San Francisco and Los Angeles (USA). Prior to that, conventional general cargo ships, tween-deck liners and trampers transported newsprint and timber (lumber). The traditional bulk carriers, though utilized in timber trade, were unsuitable for newsprint, due to their small hatches and sloped wing tanks at the bottom of the holds. The first Open hatch carriers were developed by Robert

Herbert a young naval architect working for the Ship design office Philips F. Spaulding of Seattle and Clyde Jacobs working for Crown Zellerbach an American pulp and paper company (Herbert, 1979). They designed the Open Hatch Carriers (OHC) with direct access to the hold through hatches, which extended to the full width of the vessel and box-shaped cargo holds. This enabled a smooth handling of even quite large cargo units. Either by the vessels cranes or shore-based equipment. Moreover, the hatch covers were designed with enough strength to carry lumber or project cargoes.

The two first ships Besseggen and Rondeggen were built at Kaldnes Shipyard in Tønsberg (Norway), for a Norwegian ship-owner and chartered to Crown Zellerbach Corporation (Herbert, 1979). The vessels had six (6) rectangular cargo holds, each sized precisely to stow newsprint rolls. The length of the ships was 140 meter long, the beam was 19.5 meter and they made 15 knots. In this article all units are metric apart from knots and nautical mile (nm), where 1-knot = 1nm per hour = 1852 meter. They were equipped with three gantry cranes developed by Munck cranes from Bergen (Norway) which could lift up to eight (8) paper rolls simultaneously from the quayside and place them directly into the right position in the cargo hold or on top of the hatches. In comparison, previously they had lifted one or two paper rolls by the ship derricks and then manually moved them into the right position in the cargo hold. In comparison previously

they had lifted one or two paper rolls by the ships derricks and then manually moved them into the right position in the cargo hold.

In the late 1960s trade growth on the longer, haul routes for forest products led to a rapid increase in fleet size (number of vessels). Moreover, the typical vessel size tripled within the decade, i.e. from 9000 dwt to 30 000 dwt (Stokseth, 1992). Today's Open hatch carriers typically have a dead weight of around 50 000 tons. Compared to the first vessels, i.e. Besseggen and Rondeggen today's vessels typically have 8 to 11 cargo holds, a Panama beam of 32.3 meter (the maximum for the original 1914 locks) and a length of around 200 meter. The first cranes could lift 25 tons, while the current fleet is equipped with lifting capacities from 40 to 75 ton. In addition, it has become common to equip some of the cargo-holds with tween-decks or multi-decks to enable transport of other cargo types. This to facilitate cargo types, which are not stackable, such as heavy machines, process equipment and road units.

The environmental consequences of increased international trade and transport have become important because of the current climate challenge (Rodrigue et al., 2016). Products are increasingly being manufactured in one part of the world, transported to another country and then redistributed to their final country of consumption. Seagoing vessels transport more than 80 % of this trade measured in tons. From 1970, the growth in sea transport measured in ton transported and ton-miles (freight work) has followed the average global GDP growth of 3 % annually (Lindstad 2013; Eskeland and Lindstad 2016). With a business-as-usual (BAU) scenario, with continuous transport growth as seen from 1970, future emissions are expected to increase by 150% – 250% over the period 2012–2050 (Buhaug et al., 2009; Lindstad 2013). These emission growth prospects are opposite to what is required to reach a climate targets by 2100 (IPCC, 2007). Nevertheless, it is a controversial issue how the annual greenhouse gas reductions shall be taken across the sectors. Given a scenario where all sectors accept the same reductions, a reduction of at least 85% relative to 2010 is necessary by 2050 (Anderson and Bows, 2012). This implies that the CO₂ emissions per freight work unit has to be reduced from approximately 25g of CO₂ per ton-nautical mile in 2007 to 4 g of CO₂ per ton-nautical mile in 2050 (Lindstad, 2013).

According to the third greenhouse gas study (GHG) of the International Maritime Organization (IMO), shipping emitted 938 Million ton CO₂ in 2012, accounting for 2.6% of global anthropogenic CO₂ emissions. This is a reduction compared to the 1100 Million ton CO₂ emitted in 2007 (3.5% of global emissions) and can be attributed to the increase in vessel size and lower operational speeds (Lindstad et al., 2015; Smith et al., 2014). The key observation is that when the ship's cargo-carrying capacity is doubled, the required power and fuel use typically increases by about two thirds, so fuel consumption

per freight unit is reduced (Cullinane and Khanna, 2000; Stott and Wright, 2011; Lindstad et al., 2012; Lindstad 2013; Lindstad 2015). Second, reducing operational speeds, the explanation for reduced fuel consumption is that the power output required for propulsion is a function of the speed to the power of three and beyond. This implies that when a ship reduces its speed, the power required and therefore the fuel consumed per transported unit is considerably reduced (Corbett et al., 2009; Psaraftis and Kontovas, 2010; Lindstad et al., 2011, Psaraftis and Kontovas, 2013). Table 1 show the development of average vessel size, their design and operational speeds from 2007 to 2012 (Smith et al. 2014; Lindstad et al. 2015).

Table 1: Development of Average vessel size and speed

Vessel type	Average vessel size (dwt)		Design speed (knots)		Operational speed (knots)	
	2007	2012	2007	2012	2007	2012
Dry Bulk	52 500	68 600	14.1	14.8	12.2	11.5
General Cargo	4 600	5 300	12.1	12.5	10.0	9.3
Container	34 200	41 600	20.3	21.3	16.3	14.6
Reefer	5 400	5 700	16.2	16.2	16.2	13.4
RoRo&Vehicle	7 200	7 600	16.3	16.3	15.0	15.0
Crude oil tankers	176 500	183 500	15.5	15.7	13.8	11.9
Product tankers	9 800	13 300	12.3	12.4	10.6	9.4
Chemical tankers	15 800	18 000	13.4	13.6	12.1	11.1
LNG&LPG	22 800	27 600	14.9	15.6	13.1	12.9
RoPax	1 400	1 600	17.9	16.6	13.8	10.7
Total Cargo vessels	22 500	30 800	14.1	14.6	12.0	11.1

The main observations is that the average vessel size has increased from 22 500 dwt to 30 800 dwt, i.e. 33 %, the average operational speed has been reduced from 12 to 11.1 knots, i.e. 7.5 %. In the table, there are no separate line for OHC's carriers, which are grouped under either bulk or general cargo dependent on the classification papers for each vessel. Moreover, the OHC's followed the trend for the dry bulkers, i.e. larger vessels and operational speed reductions. While speed reductions and economies of scale in vessel and shipment sizes often require changes in the supply chain due to reduced frequencies, longer transport times, port requirements and storage facilities, it is possible to introduce more energy efficient designs without changes to the logistics (Lindstad, 2013; Lindstad et al 2014; Lindstad 2015). Traditionally, ships have been built to operate at their boundary speeds based on hydrodynamic considerations (Faltinsen et. al.1980). For any given hull form, the boundary speed can be defined as the speed range where the resistance coefficient goes from nearly a constant to rise rapidly and make further speed increases prohibitively costly (Silverleaf and Dawson, 1966). For an average Panamax bulker or tanker

with block coefficient¹ in the 0.85 to 0.9 range (1.0 for a shoebox) the boundary speed area starts at 12 – 13 knots, with a gradual increase in the resistance coefficient, which approaches infinity at speeds above 16 – 17 knots (Lindstad et al. 2014). Comparing vessel types, more slender vessels designs such as deep-sea car-carriers and container vessels typically have block coefficients in the 0.55 to 0.65 range. This gives boundary speeds of 20 to 25 knots. The key lesson is that reducing the block coefficient makes the hull form more slender, increases the boundary speed, and enables higher operational speeds or lower fuel consumption when speed is kept at the same level as the more full bodied designs. See Larsson and Raven (2010) for a more extensive discussion of how hull resistance depends on speed and hull form.

The motivation for this feasibility study has therefore been to investigate the opportunities for development of Open Hatch designs, which use significantly less fuel per unit transported to contribute to the required global reductions of greenhouse gas emissions (Cop-21). While economies of scale and operational speed contributed to large reductions in fuel consumption and emissions from 2007 to 2012, their additional potential is less obvious (Lindstad and Eskeland 2015). Crude Tankers peaked in size during the 1970's at 540 000 dwt, while the largest tankers built today is just 2/3 of that size. Moreover, the largest container vessels might peak at present levels of around 22 000 TEU's. *Neither are there a large potential through additional operational speed reductions since operational speeds already have been significantly reduced compared to pre the financial crisis in 2008 (Smith 2014; Lindstad 2015, Lindstad and Eskeland 2015).* For these reasons, we performs a parametric feasibility study focusing on identifying cost and improvement potentials for new alternative designs versus the present.

MODEL DESCRIPTION

The main objective of the model is to calculate power, emissions and costs for the alternative designs as a function of their characteristics and the amount of transported cargo.

The power function (equation (1)) (Lewis, 1988; Lloyd, 1988; Lindstad 2013; Lindstad et al. (2014; and Lindstad 2015) considers the power needed for still-water conditions, P_s , the power required for waves, P_w , the power needed for wind resistance, P_a , the required auxiliary power, P_{aux} , and the

¹ Block coefficient is defined as $C_B = \frac{\nabla}{L \cdot B \cdot T}$ where ∇ is the displaced volume, L is length, B is beam and T is draught

propulsion efficiency, η . This setup is established practice (Lewis, 1988; Lloyd, 1988; and Lindstad, 2013).

$$P_i = \frac{P_s + P_w + P_a}{\eta} + P_{aux} \quad (\text{Eq. 1})$$

The required power for the alternative designs in this study are based on ShipX, which is a hydrodynamic workbench developed by MARINTEK (now Sintef Ocean), and the added resistance in waves is computed by the use of the STA-wave method.

The boundary speed function (equation (2)) is based on Silverleaf and Dawson (1966).

$$V_b = (1.7 - 1.4 * C_b) * \sqrt{\frac{L}{0.304}} \quad (\text{Eq. 2})$$

Here, C_b is the block coefficient and L is the length of a ship in the waterline from the forward stem, or forward perpendicular, to the sternpost or aft perpendicular. The formula was developed based on analysis of more than 100 single-screw forms and 50 twin-screw forms, having block coefficients in 0.5 to 0.86 range. The constant, i.e. 0.304 converts the ship length in meter to feet. The boundary speed V_b is given in knots.

The building cost $Capex$ (equation 3), for the alternative designs is calculated based on the building cost of the reference vessel.

$$Capex_{v_{New}} = Capex_{v_{Ref}} \cdot \left(1 + \sum_{j=0}^n (\Delta_j) \right) \quad (\text{Eq. 3})$$

Here the cost adds up from the cost delta Δ versus the reference vessel for the main cost parameters, i.e. steel weight, main measurements, installed power, cargo holds and cargo handling.

The daily time charter equivalent cost (TCE), for each of the alternative vessels are calculated as expressed by equation 4.

$$TCE_v = Capex_{k_1, k_2, k_3} \quad (\text{Eq. 4})$$

Here k_1 is the daily depreciation and k_2 the interest as a function of newbuilding price, and k_3 gives the daily operational cost as a function of vessel age, manning, maintenance and operational policy. Here the TCE expresses

what is required to pay back the new vessel over the given depreciation period, i.e. usually 15 or 20 years, cover all the operational cost and give the required return on the owners capital. In the real shipping market, the achieved Time Charter (TC) will periodically be both higher and lower than the TCE during the vessel 20 to 25 years use time.

The fuel consumption per voyage is calculated as expressed by equation 5.

$$F = \sum_{i=0}^n \left(\frac{D_i}{v_i} \cdot ((K_f \cdot P_i)) \right) + \left(D_{lwd} \cdot ((K_f \cdot P_{lwd})) \right) \quad (Eq. 5)$$

The equation consists of two terms: the first calculates fuel at sea and the second fuel in ports. During a voyage, the sea conditions will vary and this is handled, by dividing each voyage into sailing sections, with a distance D_i for each sea condition, and the total for the voyage is given by the summation of the sailing sections from zero to n . The second factor (D_i/v_i) gives the hours in each section of the voyage. The fuel consumption per section is given by $(K_f \cdot P_i)$, where K_f is the fuel required per produced kWh as a function of engine load and P_i the power required. The second term calculates fuel in ports when loading, discharging and waiting based on total days used D_{lwd} and the average power required P_{lwd} .

The cost per freight unit transported comprises the fuel cost and time charter equivalent cost (TCE), as expressed by equation 6:

$$C = \frac{1}{M \cdot D} \left(\sum_{i=0}^n \frac{D_i}{v_i} + D_{lwd} \right) \cdot TCE_v + F \quad (Eq. 6)$$

The equation consists of two terms, the first calculates cost at sea and the second calculates cost in ports. Here M is the weight of the cargo carried and D is the distance sailed including both the loaded and the ballast leg.

The amount of CO_2 or CO_2 eq. (which includes all Greenhouse gases) emitted per ton nautical mile ε is calculated as follows:

$$\varepsilon = \frac{F}{M \cdot D} \cdot K_{ep} \quad (Eq. 7)$$

Here, K_{ep} is the emission factor for the CO_2 or CO_2 eq. function of engine load.

EXISTING FLEET

The current Open Hatch Fleet (2017), consists of around 500 vessels, with sizes from 25 000 dwt for the smallest up to nearly 75 000 dwt for the largest. This corresponds to lengths from 150 m up to 225 m and beams from 26 m up to 32.3 m. In addition, there are a few vessels, which recently has been built with post Panamax beams of 36 m. The new Panama locks allows up to 49 m beam. As in the 1960s, the vessels are usually geared, either by two (2) gantry cranes or by three (3) or four (4) slewing cranes. Table 2, show typical design characteristics (not the specific details of any vessel) of vessels from 199 meters and upwards, i.e. the largest carriers.

Table 2: Typical design characteristics of OHC's

	Ship - A	Ship - B	Ship - C	Ship - D
Loa - length (m)	199.99	199.99	225	210
Beam (m)	32.3	32.3	32.3	36
Draught (m)	12	13.5	14	14
DWT (ton)	47 000	61 000	70 000	70 000
Displacement (ton)	60 000	75 000	85 000	85 000
Grain (m ³)	60 000	70 000	85 000	85 000
Block coefficient	0.80	0.85	0.80	0.81
Cargo-holds	11	8	8	8
Speed (knots)	16	14	15.5	14.5

The first of these vessels, i.e. Ship-A is designed to keep within main canal, fairway and port restrictions. This implies less than 32.3-meter beam for the original Panama Canal locks; less than 200 meters length to be within favourable rules in countries like Japan and to fit within the maximum lengths of most ports; and a 12 m draught that can be better utilized in more ports and fairways compared to larger draughts. With up to 11, cargo-hold's she is built for taking part loads in general and forest products in particular, i.e. paper rolls and packages of beams and planks. Ship-B is also built, within the 200 m length limit and the original Panamax beam of 32.3 m, however she has a larger draught, i.e. 13.5 meter. Moreover, she has a more full-bodied hull form, i.e. 0.85 in block coefficient compared to 0.80 for Ship A, which in total gives nearly 25 % more deadweight, but also higher resistance through water and lower speed. Ship-C has the same beam as A and B, while the length are increased to 225 m, which is a typical length of what used to be termed a Dry Bulk Panamax vessels. Ship-D have Post-Panamax beams of 36 m and a length of 210 meters. The increased length of Ship-C and the length and beam increase for Ship-D in addition to a larger draught increases their dead weight with 50%, compared to Ship-A.

HISTORIC DEVELOPMENT OF THE FLEET AND TRANSPORT EFFICIENCIES

The historical emission calculations are based on; vessels, which has been trading with lumber (timber) export from the USA and Canadian west coast. For the time between the wars, we have added some characteristic tramp vessels of the time, which represents the technical development. The majority of the pre Second World War vessels was trading in the Pacific. After 1945, trade patterns have become more global. In order to present a comparable historical development, we have chosen to use a one way, voyage distance of 9000 nm for all vessels. For example British Columbia via Panama to Europe. Each vessel is plotted based on delivery year and will hence be sailing the next 20 to 25 years. For the older vessels, i.e. Steam Ships Coal Fueled (SS- Coal) Steam Ship Oil Fueled (SS- Oil) and Motorship General Cargo (MS- GC) the ships data including Speed – Consumption figures are taken from the following sources:

1. DNV (Det Norske Veritas Register
2. Norways Cargo Fleet 1923 – 1924, Christiania 1923.
3. Københavns Skibssalgs Bureau – Ship Sales Lists 1922-1939
4. Otto Danielsen The Ship Sales List – 1946 – 1961
5. British Ocean Tramps by P.N. Thomas. Wayne Research Publications ISBN 0905184
6. The Evolution of the Cargo Ship during the last 36 years, with some thoughts on the years to come – 2nd Amos Ayre Lecture - 1958 by J. Ramsay Gebbie, D.Sc (Vice President). RINA 1958
7. Svensk Teknisk Tidskrift – 1919 – 1939.
8. Standard Cargo Ships by Sir George Carter, KBE – RINA 1918
9. Design and Construction of Merchant Ships by L.J.Le Mesurier and H.S. Humphreys – NEC IES 1935
10. Data Book AS Fredrikstad Mek Verksted including Pocket Plans – Fredrikstad Museum.

Loading for these vessels are according to - *Modern Ship Stowage* – US Department of Commerce 1941 and checked against timber intake where known. Water- absorption in deck cargo is not considered as double bottom could be used alternatively for diesel oil and water-ballast. The ships are loaded to summer draught. For the Dry-Bulk vessels, pocket

plans have been available, and these have been loaded estimating deck cargo capacity based on deck plan and height according to deck/hatch uniform load. The vessels are then being stowed with 67.5 cubic feet per long ton (1016 kg) in hold (partly machine stow) and 10% looser stow on deck. Open hatch vessels are stowed the same way, but with 70 cubic feet per metric ton and 10% looser stow on deck. For all vessels maximum cargo carrying capacity for cargo has been calculated to be:

- Available cargo weight = Dwt minus 1.2 x required fuel for 9000 nm
- For coal-fired vessels, we have assumed bunkering midway, due to the low energy density of coal per cubic-meter compared to diesel and bunker oil (HFO).

For vessels built from 1960 onwards, i.e. dry bulk, open hatch and open hatch gantry the following sources have been used:

11. Economic Factors in Transportation of Forest Products in bulk by Graham I. Bender. Paper IIIC, SNAME Spring Meeting, May 1975.
12. Design of the SCA Special ships by Robert N. Herbert – Marine Technology, Vol 8, No 4, October 1971.
13. Design and Construction of 45000 Dwt “M” Class Open – Hatch Bulk Carriers – by K.T. Liu, Herbert Engineering Corp – SNAME Joint Northern California Section and ASNE Meeting December 1978.
14. Trends in marine transports of forest products by Robert N. Herbert – Transport and Handling in the Pulp and Paper Industry Volume 2 1977
15. Seaweb.com
16. Significant Ships- published by RINA.

Fig 1 to Fig 6 shows the development of the fleet per vessel type from 1900 up until today. The content of the figures are:

1. Vessel speed in knots
2. Boundary speed in knots
3. Vessel speed / Boundary speed
4. Corresponding required power / Boundary Power
5. Ton CO₂ per ton available transport capacity
6. Ton CO₂ per cubic meter transport capacity

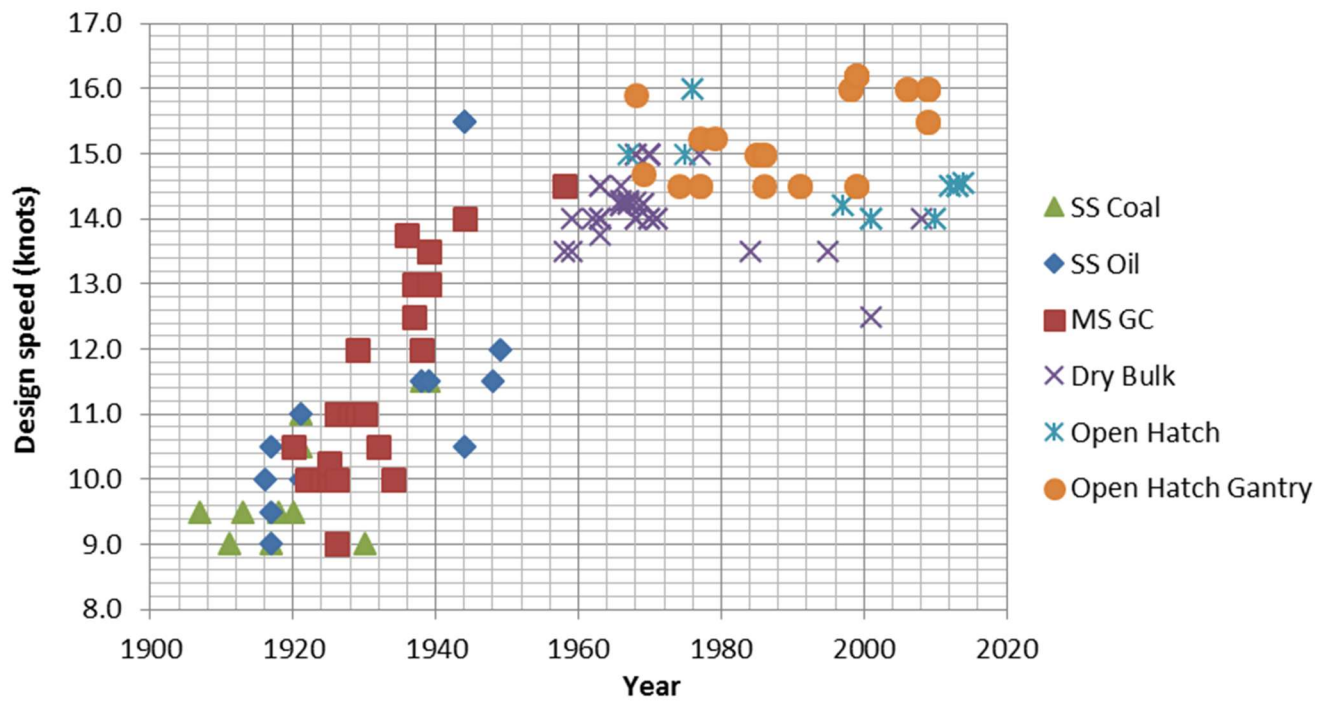

Fig. 1: Development of Vessel speed from 1900 – 2015

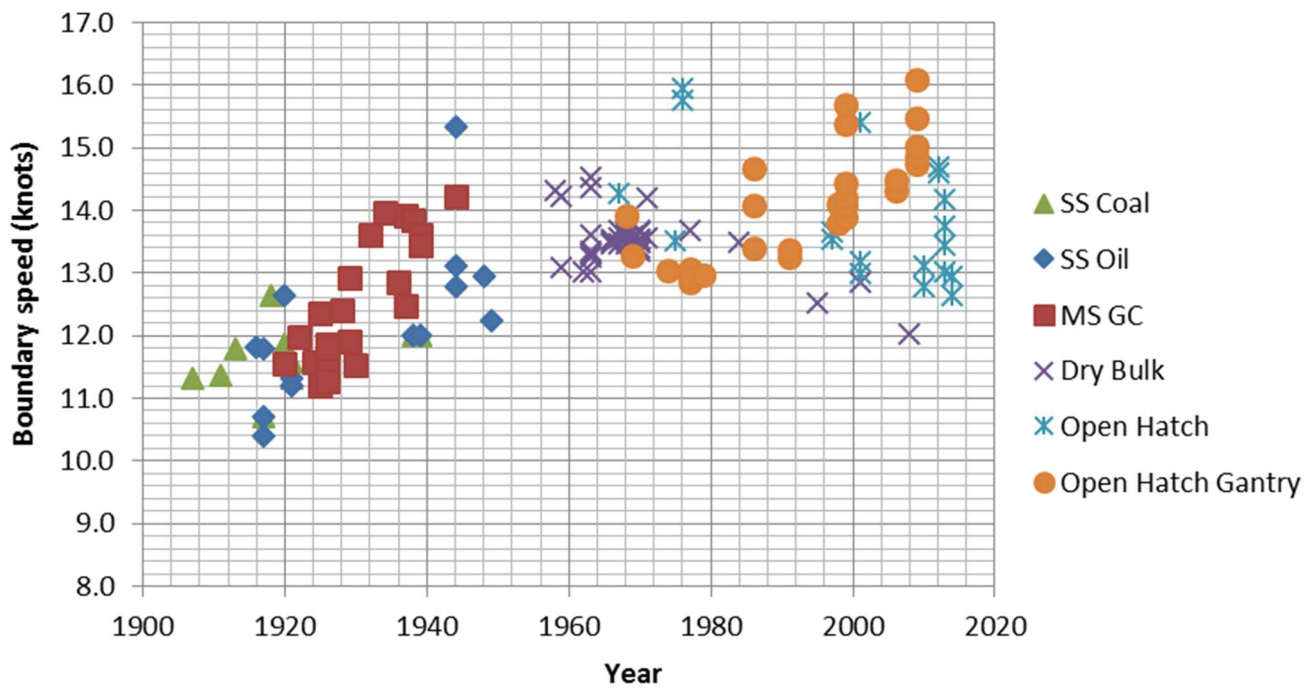

Fig. 2: Development Boundary speed from 1900 - 2015

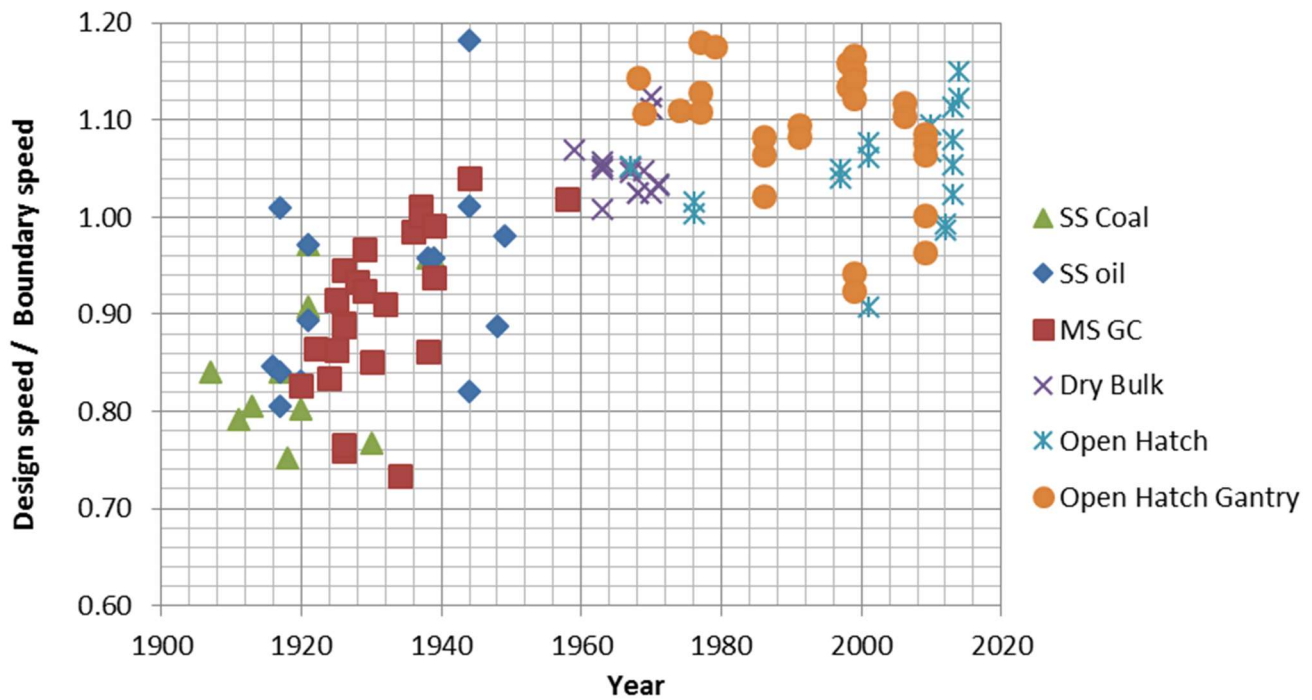

Fig. 3: Development of Vessel speed / Boundary speed from 1900 – 2015

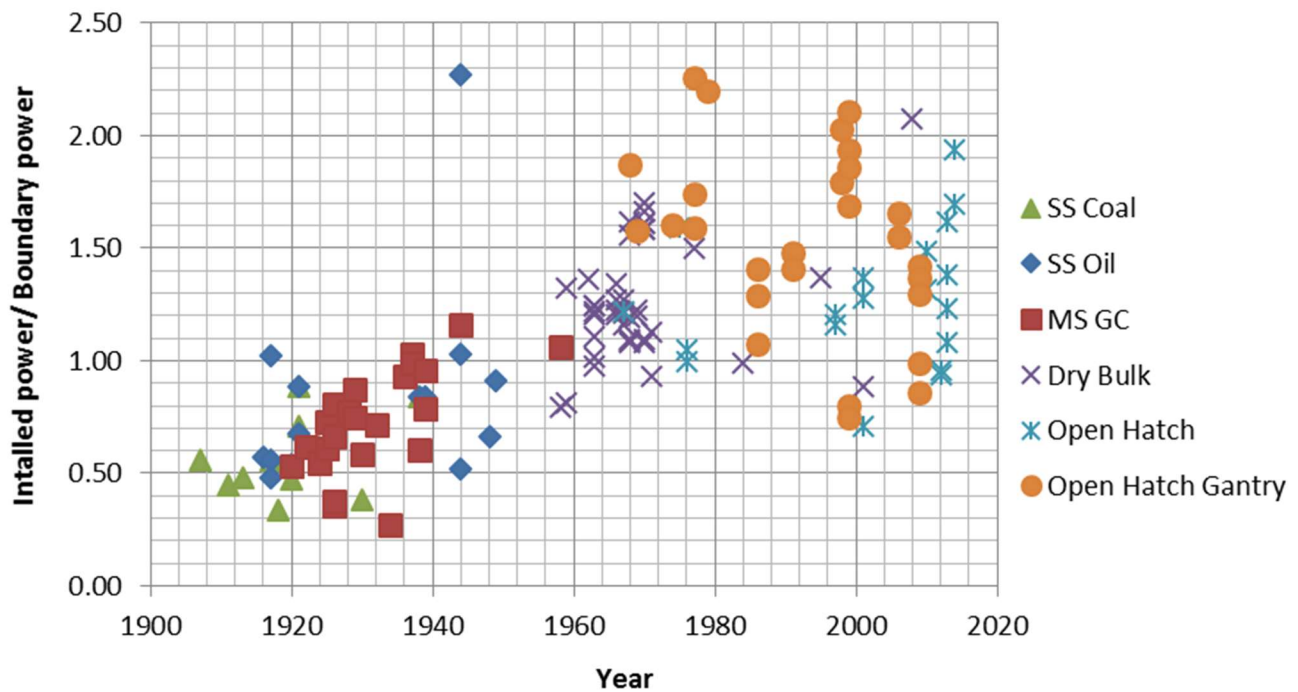

Fig. 4: Development of Corresponding required power / Boundary power from 1900 - 2015

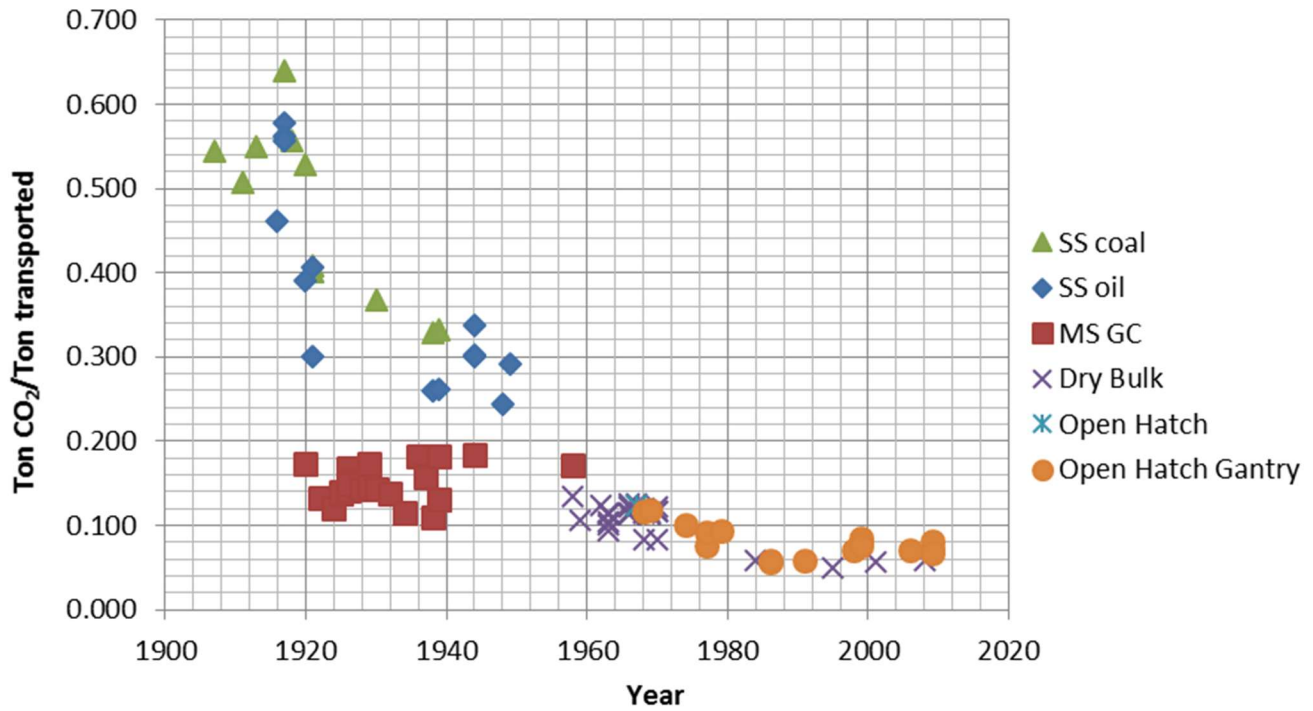

Fig. 5: Development of Ton CO₂ emissions per ton available transport capacity from 1900 – 2015

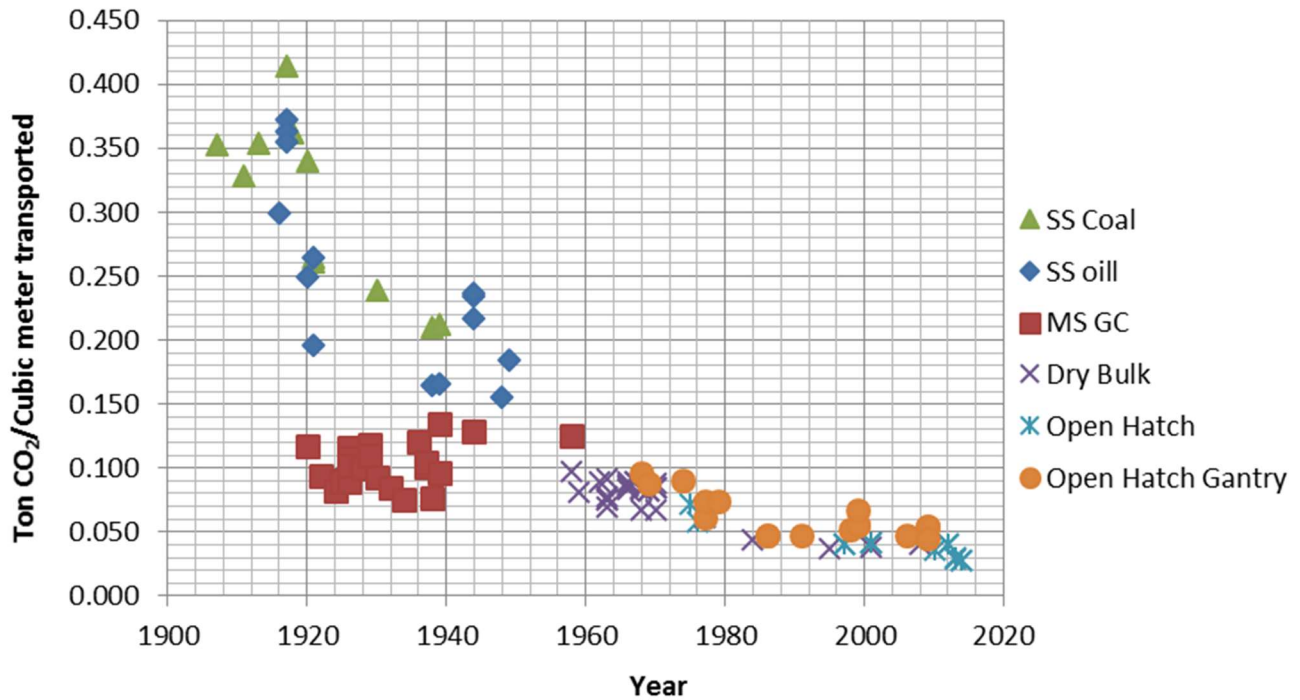

Fig. 6: Development of Ton CO₂ emissions per cubic meter available transport capacity from 1900 - 2015

The main observations are; First, design speeds increased from 9 and above around 1910 to 14 to 16 knots from 1960 onwards when the OHC's was introduced. Second, the boundary speeds for the designs has increased less than the design speed. Third, due to this we have gone from a situation where boundary speeds was higher than the design speeds in general up to 1960 to the opposite from 1960 onwards. Fourth, design speeds/ boundary speeds ratios higher than one comes at a high power demand as expressed by Fig 4. Fifth, when diesel engines replaced steam engines ton CO2 emitted per ton or cubic meter available transport capacity was reduced by around 50 %. Sixth from 1960 onwards the CO2 emissions per ton transported has gradually been reduced due to the economies of scale benefits of larger vessels which benefit has out- weighted the negative effects of powering the hulls to achieve speeds above their boundary speeds. Seventh, to summarize the figures indicates that additional fuel and emissions reductions are available by employing hull forms with higher boundary speeds. Alternatively, if required operational speeds over time are considerably lower than the requirements when today's fleet was built reduce installed power to bring design speeds including sea margins more in line with today's operational requirements.

As can be seen from Fig. 7 increasing the vessel speed beyond its boundary speed is detrimental to its power demand. A vessel speed-to-vessel boundary speed ratio above one will lead to an exponential increase in power demand, which in turn will lead to a higher fuel cost.

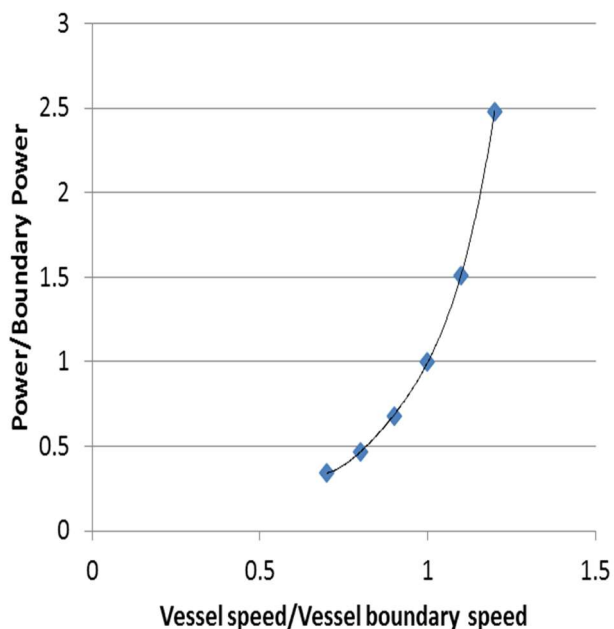

Fig. 7: Variation in power with deviation from the boundary speed. (Table II p.171 Silverleaf & Dawson (1966) and own calculations)

ANALYSIS

In order to investigate alternative designs, we perform a parametric feasibility study. The study focus on identifying cost and improvement potentials for new, alternative designs versus the existing ones. Fig. 8 shows the main characteristics, i.e. length, beam, dwt, and block coefficient for the alternative designs. The box at the left hand side of the figure shows the main characteristics of the reference vessel. First, we investigate how power can be reduced by increasing beam and keeping cargo capacity constant. Second, we investigate power requirements when varying cargo carrying capacity through the block coefficient and keeping external dimensions constant. Third, we investigate power required when varying length and keeping beam and draught constant

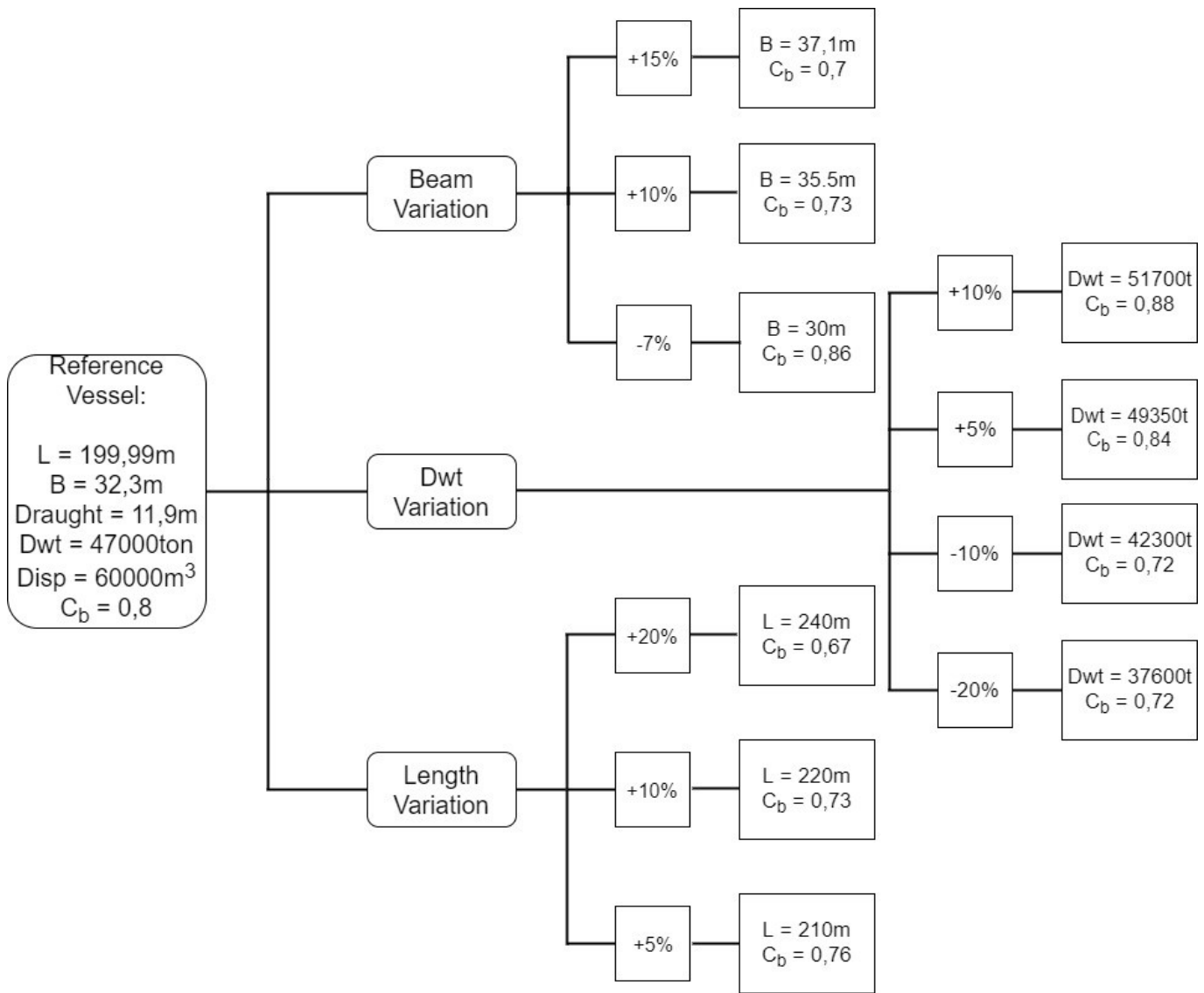

Fig. 8: Display of the different designs analysed in the parametric feasibility study

The reference and the alternative designs are analyzed with respect to predicted power, both in calm water, and rough sea, for which we have used 4m significant head waves ($H_s = 4m$) as a proxy. Rougher sea will increase the additional resistance further, but even in the North Atlantic, the significant wave height is less than 5.5 m more than 90 % of the year (Bales et al 1981), while waves between 2.- 5.5 meter occurs 55% of the year.

Fig 9 to 12 shows the main results from the parametric study. The content of the figures are:

9. Beam variation from 30 – 37.1 meter (reference ship is 32.3 meter)
10. DWT variations from 37 000 – 52 000 ton (reference ship is 47 000 ton)
11. Length variations from 200 – 240 meter (reference ship is 200 meter, beam 32.3 meter, block 0.80 and dwt 47 000 ton).
12. Gram CO2 per ton available transport capacity and total consumption per voyage for a 9000 nm. For some of the alternative designs and the reference vessel with 12 and 16 knots speed at calm water (70% of the time) and in 12 knots with 4 meter, significant head waves 30% of the time.

Beam [30m – 37.1m], LOA=199.99m, DWT=47,000t

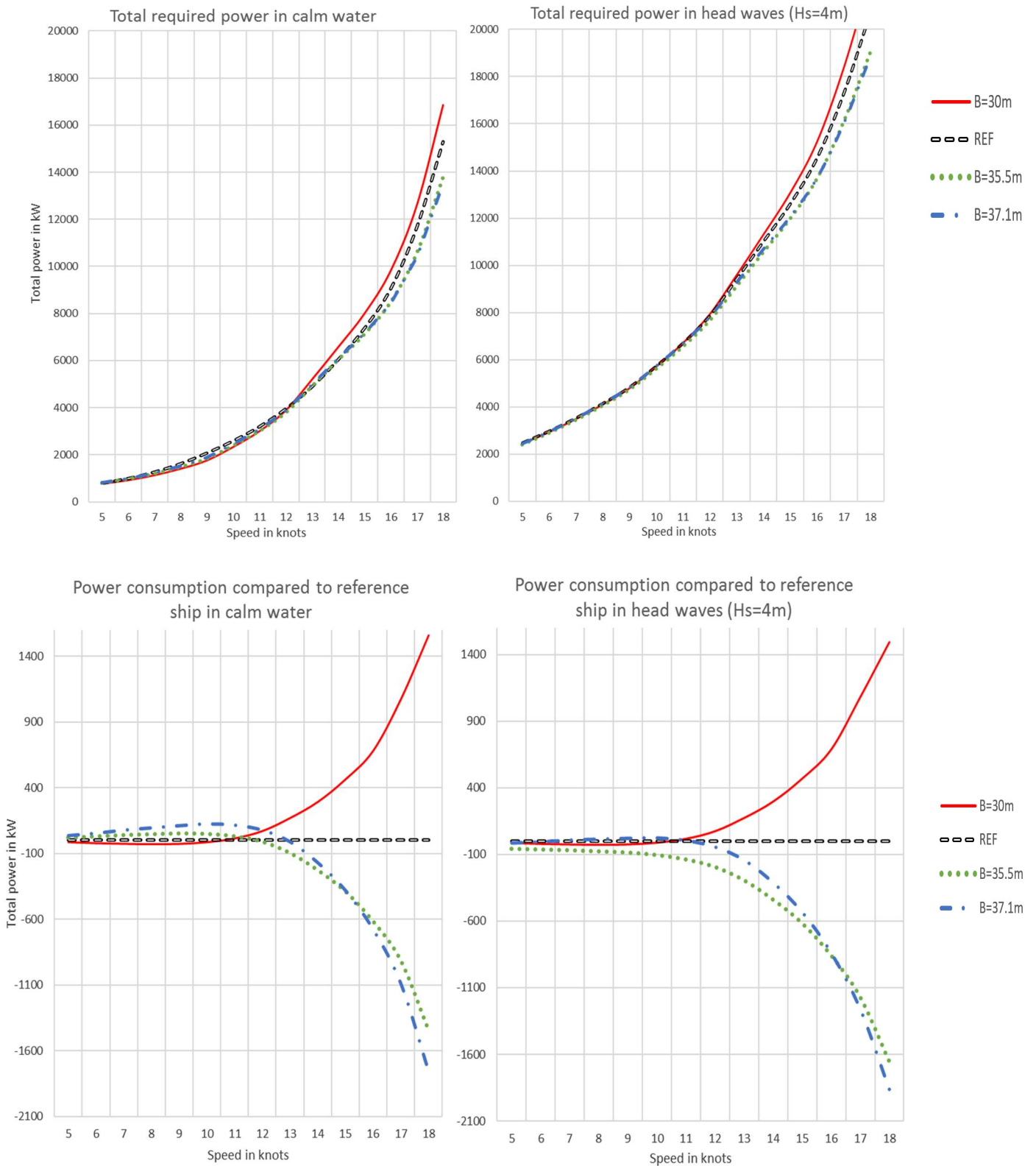

Fig. 9: Power predictions in calm and rough sea with beam as variable

DWT [37,000t – 52,000t], LOA = 199.99m, Beam=32.3m

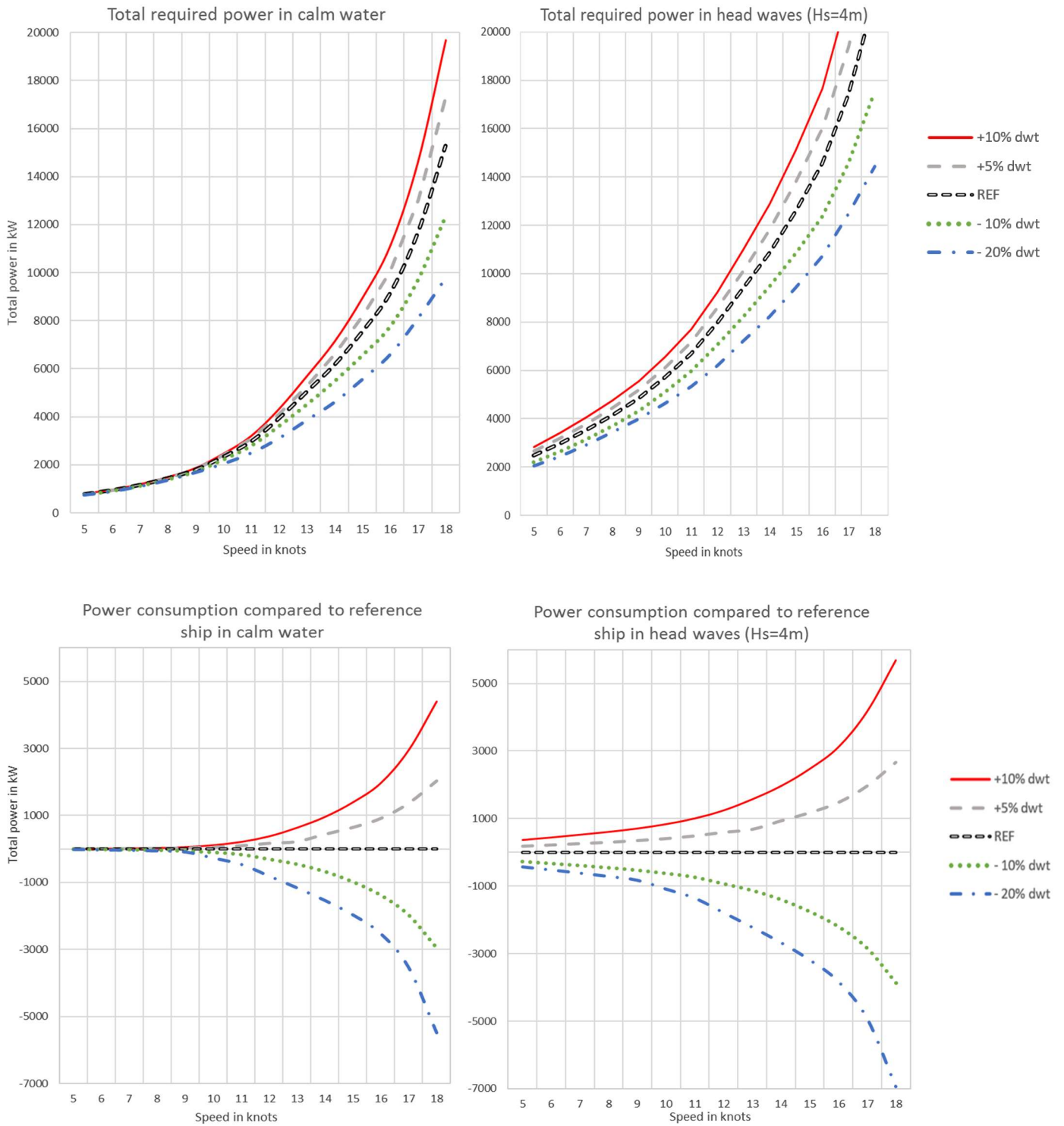

Fig 10: Power predictions in calm and rough sea with dwt as variable

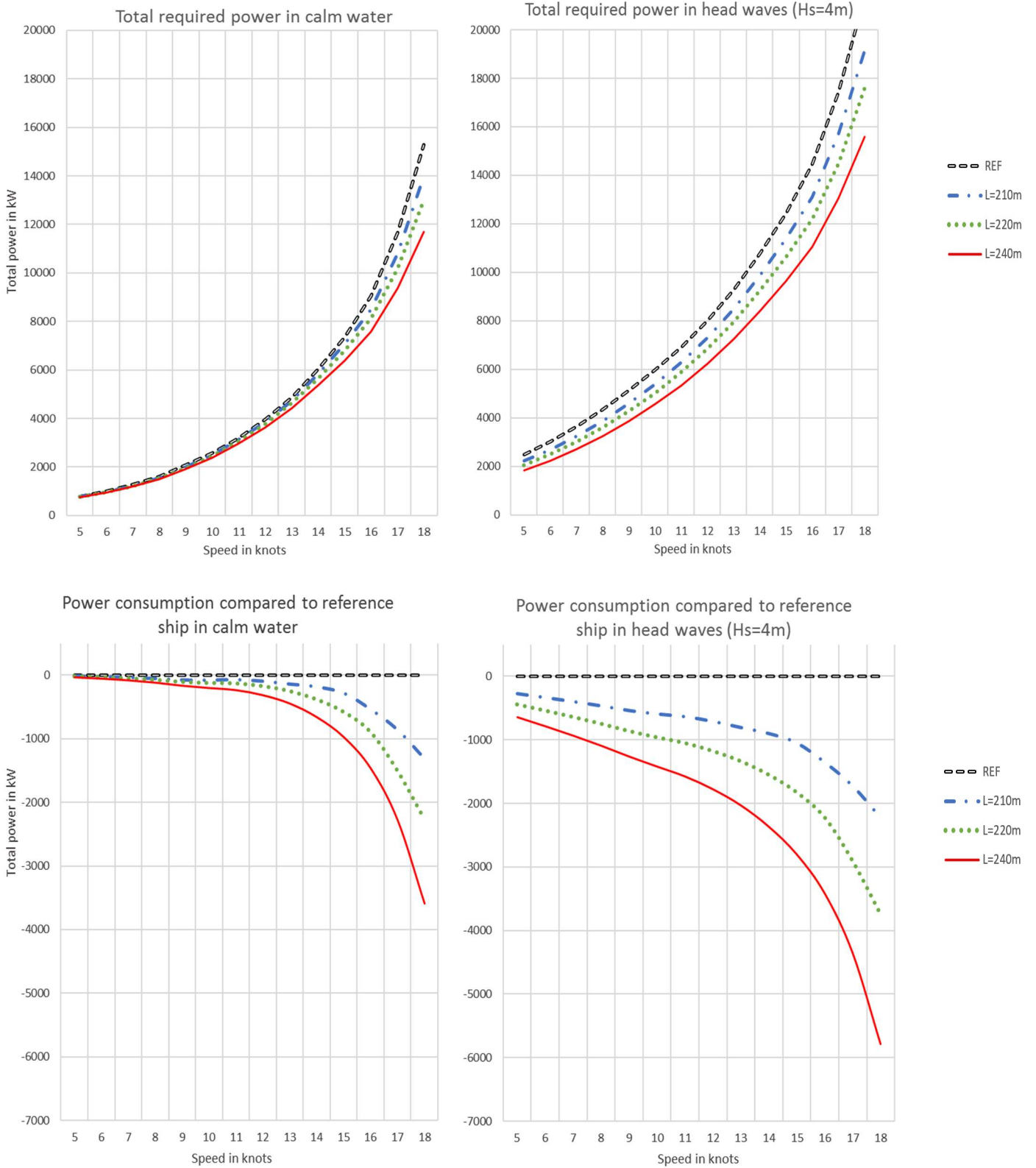

Fig. 11: Power predictions in calm and rough sea, with length as variable

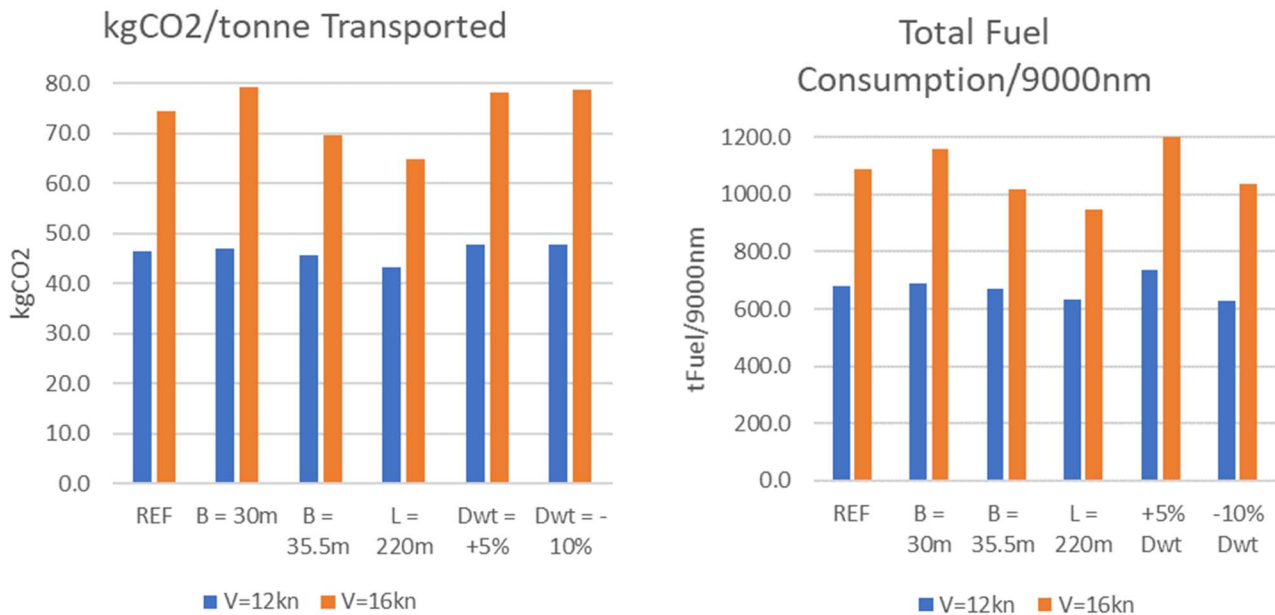

Fig. 12: Kg CO2 per ton available transport capacity and total consumption per voyage for a 9000 nm at 12 and 16 knots voyage speed in calm water (70% of the time and 30% of the time at 12 knots in 4 meter significant head waves)

As can be seen from Fig. 9-12, the favorable designs (from the perspective of reducing required power) are the ones enabling lower block coefficients, i.e. a more slender vessel. The designs with longer length outperforms the beam varying designs, since the Froude number plays decisive role in power predictions and the length varying designs have a smaller cross-section faring through the water. The dwt-varying designs show a great reduction in power with decreasing dwt. However, this advantage is not as transparent as with the other two design-alternatives, since the carrying capacity of the vessel is reduced which influences the results in the cost analysis.

From Fig. 10 it is clear that if we keep main dimensions constant (length, beam, draught), high speeds and rough sea favors slender designs, as opposed to calm water and speeds of 10 – 12 knots. Which implies that with average operational speeds of 10 – 12 knots the additional cargo carrying capacity of the full-bodied designs more than pays for the additional fuel.

Overall increasing the length is the most efficient way to lower power demand and cost as illustrated by Fig 11. Traditionally increasing length have been considered more expensive than increasing beam or draught (on a cost per meter basis). We follow that practice and calculate newbuilding and capex cost with adjusted factors to mirror this. While the operational cost of the alternative designs will be similar. We use 50 MUSD as the newbuilding cost for the reference vessel and a voyage length of 9000 nm. Fig 13 shows cost per ton transported and per trip at fuel price equal to 300USD/ton fuel and 500USD/ton Fuel. Moreover, the speeds are 12 and 16 knots speed at calm water and 12 knots in rough sea 30 % of the time. Loading and unloading time is set to 7 days in total for the voyage.

The results indicates that at low speeds and fuel, i.e. 12 knots and 300 USD/ton the reference design outperforms the more slender alternatives. While at high speeds, the 220-meter design with a block of 0.73 achieves a 5 % cost reduction per ton transported compared to the reference vessel. Closely followed by the 200-meter option with a beam of 35.5 meter with a block of 0.73.

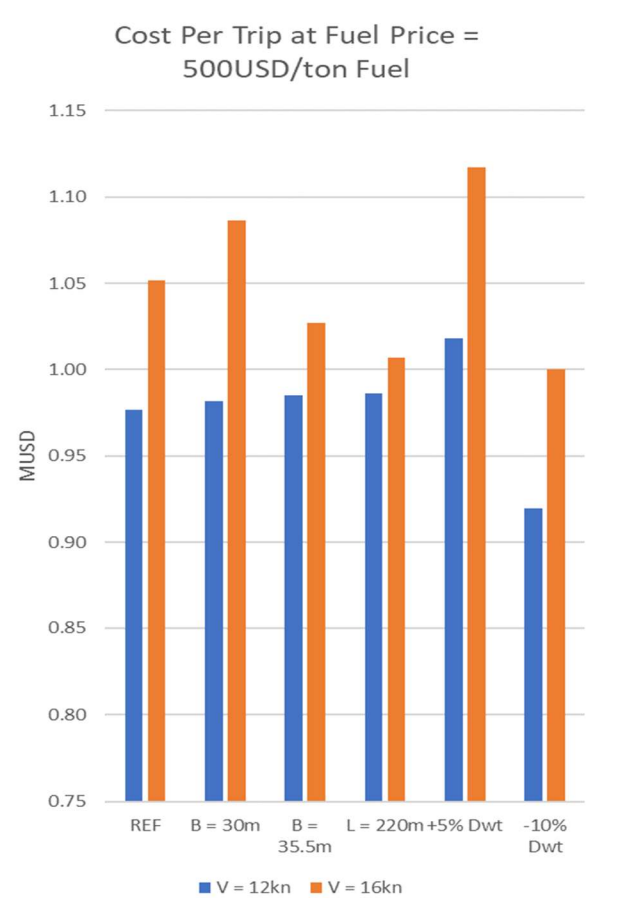
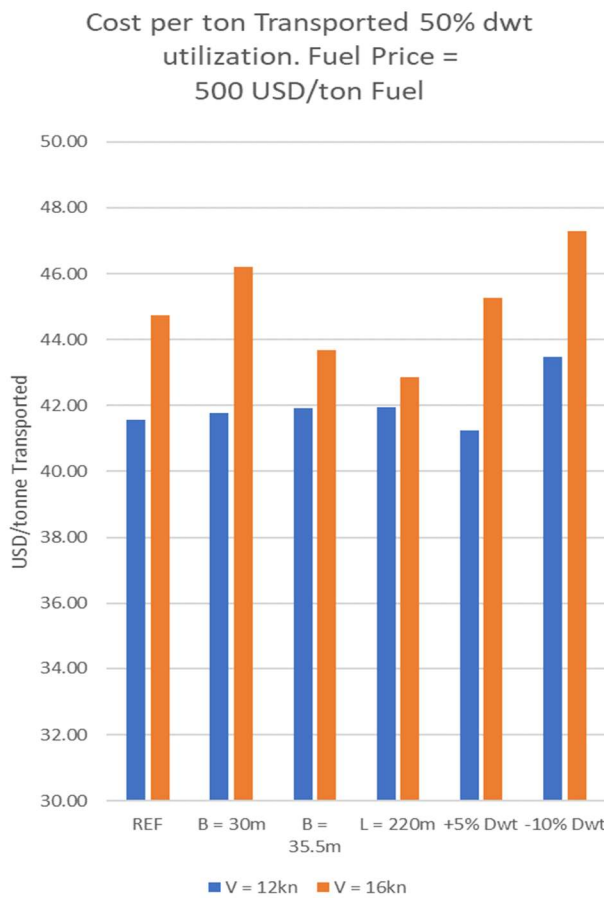
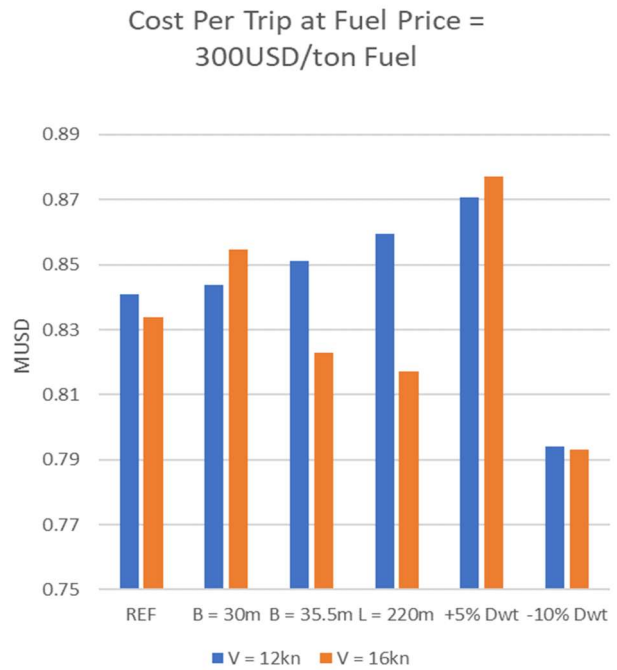
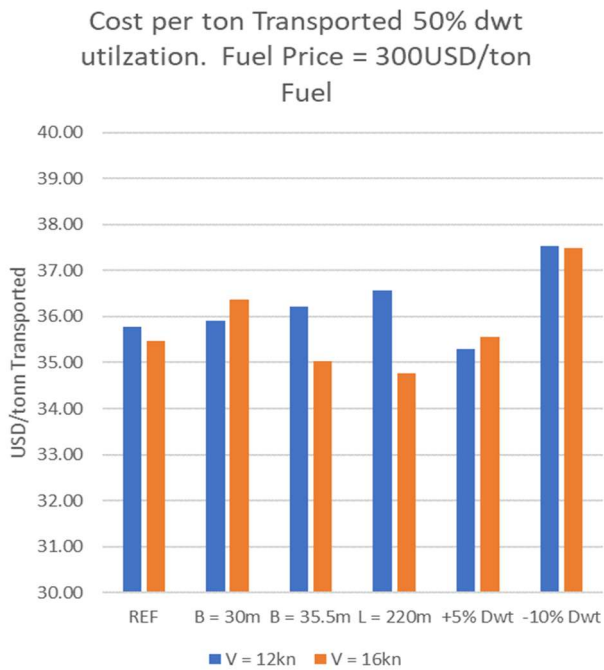

Fig. 13: Cost per ton transported and per trip at fuel price equal to 300 USD/ton and 500 USD/ton

DISCUSSION AND CONCLUSIONS

The motivation for this parametric feasibility study has been to investigate the opportunities for development of new Open Hatch designs, which use significantly less fuel per freight unit transported and can be built and operated at a modest cost. The results indicates that alternative combinations of main dimensions to enable lower block coefficients reduces fuel consumption and greenhouse gas emissions (GHG) per freight unit transported. Fig 14 shows the boundary speed for alternative designs. Here, the boundary speed by the formula is in middle of the shaded area for each of the designs. We see that the designs with the lowest block coefficients, i.e. with a beam of 35.5m, with a length of 220m, or with a reduced dead-weight achieves the highest boundary speeds.

From Fig. 9-13 we can deduct that required voyage speed is a main input parameter to the design process. It could be argued, that this is obvious, however Fig 1 - 4, shows that this has a tendency to be overlooked, i.e. vessels are frequently pushed far beyond their boundary speeds. Having a ship travelling at lower voyage speeds may be favourable both for new and for already existing designs. However, in order to meet the ongoing increase in energy efficiency demands, set by IMO, and customers and consumer worldwide, ships should be designed with focus on keeping their boundary speed above their design and required voyage speed.

From Fig. 13 we see that if 12 knots is the required voyage speed and we assume that fuel prices stays at the present level, i.e. around 300 USD per ton, traditional full bodied designs gives the lowest cost per ton transported. If fuel price increases to 500 USD or above, which might happen in 2020 with the Sulphur cap, the more slender designs outperforms the traditional designs even at 12 knots operational speeds. When the operating speed of the vessels increases, more slender hull design gives better results even with the lowest fuel price, as hull form plays a bigger role in power and cost predictions. It seems that higher fuel cost, may help to align the optimized design for minimum transport costs/ton-mile, with optimum designs for minimum CO₂/ton-mile.

Moreover, designs where design and operational speeds are kept well below the boundary speed will increase the competitiveness of Open Hatch vessels versus their competitors, i.e. dry-bulk, container and Ro-Ro.

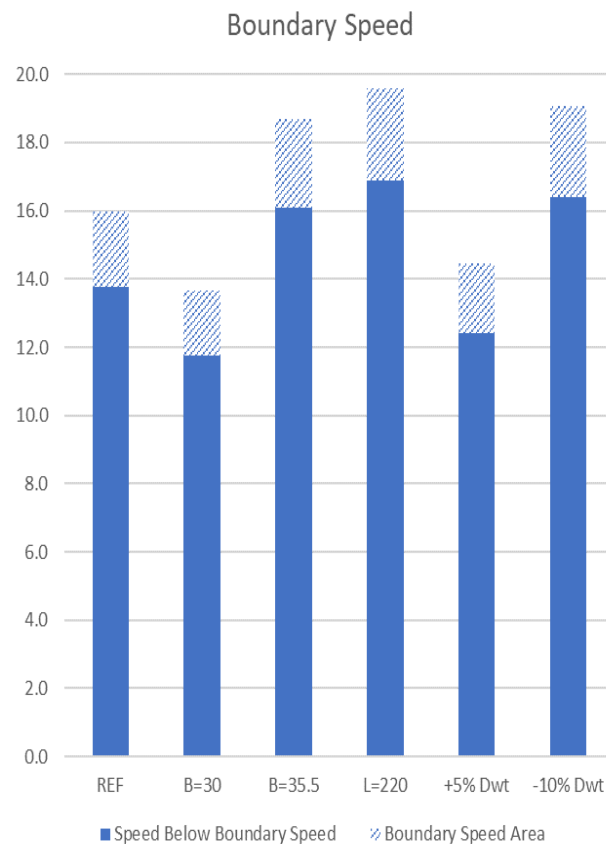

Fig. 14: Boundary speed of the different designs

ACKNOWLEDGEMENT

This study has been financially supported by the Norwegian Research Council project (Norges Forskningsråd) 237917. *The SFI Smart Maritime*

REFERENCES

- Anderson, K., Bows, A., 2012. *Executing a Scharnow turn: reconciling shipping emissions with international commitments on climate change*. Carbon Management. 3 (6), 615–628.
- Bender G. I. 1975. *Economic Factors in Transportation of Forest Products in bulk*. Paper IIIC, SNAME Spring Meeting, May 1975.

Buhaug, Ø.; Corbett, J.J.; Endresen, Ø.; Eyring, V.; Faber, J.; Hanayama, S.; Lee, D.S.; Lee, D.; Lindstad, H.; Markowska, A.Z.; Mjelde, A.; Nelissen, D.; Nilsen, J.; Pålsson, C.; Winebrake, J.J.; Wu, W.-Q.; Yoshida, K., 2009. *Second IMO GHG study 2009*. International Maritime Organization, London, UK, April

Cop 21, 2015. The 21st yearly session of the Conference of the Parties (COP) to the 1992 United Nations Framework Convention on Climate Change (UNFCCC). The conference negotiated the Paris Agreement, a global agreement on the reduction of climate change, which represented a consensus of the 196 parties (countries).

Carter, G. (Sir), 1918. *Standard Cargo Ships*, KBE – RINA

Corbett, J.J., H. Wang, and J.J. Winebrake, *The effectiveness and costs of speed reductions on emissions from international shipping*. Transportation Research Part D: Transport and Environment, 2009. 14(8): p. 593-598.

Cullinane, K., Khanna, M. 2000. *Economies of scale in large containerships: Optimal size and geographical implications*. Journal of Transport Geography, 8 (3), Page 181-195.

Eskeland, G., S., Lindstad, H., E. 2016 *Environmental Taxation of Transport*. The International Journal on Green Growth and Development 2:2 (2016) Page 51-86. ISSN 2393-9567

Faltinsen, O.M., Minsaas, K.J., Liapis, N., Skjørdal, S.O., 1980. *Prediction of resistance and propulsion of a ship in a Seaway*. In: Proceeding of the 13th Symposium on Naval Hydrodynamics, Tokyo, the Shipbuilding Research Association of Japan, 1980, pp. 505–529.

Herbert, Robert, N. 1977/1971. *Design of the SCA Special ships* Marine Technology, Vol 8, No 4, Oct 1971.

Herbert, Robert, N. 1977. *Trends in marine transports of forest products – Transport and Handling in the Pulp and Paper Industry* Volume 2 1977

Herbert, Robert, N, 1979. *The history of Open Hatch*. In Kummerman, H., Jacquinet, R., (Eds.) *Cargo Ships*. MacGregor Publications Ltd, Hounslow, England

IPCC, Climate Change, 2007. Synthesis Report. Contribution of Working Groups I, II and III to the Fourth Assessment Report of the Intergovernmental Panel

Kumar, S. Hoffman, J., 2002, *Globalisation the Maritime Nexus*. In Grammenos, C.T. (editor): *The Handbook of Maritime Economics and business*. Page 35-64, LLP ISBN 1-84311-195-0

J. Ramsay Gebbie 1958. *The Evolution of the Cargo Ship during the last 36 years, with some thoughts on the years to come*. 2nd Amos Ayre Lecture. RINA

Larson, L., Raven, H., C., 2010. *The Principles of Naval Architecture Series: Ship Resistance and Flow*. SNAME 2010, ISBN 978-0-939773-76-3

Lewis E.D, 1988. *Principles of Naval Architecture, Vol. II*. The Society of Naval Architects and Marine Engineers, ISBN0-939773-01-5

Lindstad, H., Asbjørnslett, B.E., Strømman, A.H., 2011. *Reductions in greenhouse gas emissions and cost by shipping at lower speed*. Energy Policy 39, 3456–3464.

Lindstad, H. Asbjørnslett, B., E., Strømman, A., H., 2012. *The Importance of economies of scale for reductions in greenhouse gas emissions from shipping*. Energy Policy 46 (2012) 386-398

Lindstad, H. 2013. *Strategies and measures for reducing maritime CO2 emissions*, Doctoral thesis PhD. Norwegian University of Science and Technology – Department of Marine Technology. ISBN 978-82-461- 4516-6 (printed),

Lindstad, H., Steen, S., Sandass, I. 2014. *Assessment of profit, cost, and emissions for slender bulk vessel designs*. Transportation Research Part D 29(2014) 32-39

Lindstad, H., Steen, S., Sandass, I. 2014. *Assessment of profit, cost, and emissions for slender bulk vessel designs*. Transportation Research Part D 29(2014) 32-39

Lindstad, H, 2015. *Assessment of Bulk designs Enabled by the Panama Canal expansion*, (SNAME. Transactions 121, page 590-610, ISSN 0081 1661

Lindstad, H., et al., 2015. *GHG Emission Reduction Potential of EU-Related Maritime Transport and on its Impacts*. European Commission, CLIMA.B.3/ETU/ 2013/0015, TNO 2014 R11601.

Lindstad, H., Eskeland, G., S., 2015 *Low carbon maritime transport: How speed, size and slenderness amounts to Substantial Capital Energy Substitution*. Transportation Research Part D 41 (2015), page 244-256

Liu K.T. 1978. *Design and Construction of 45000 Dwt "M" Class Open – Hatch Bulk Carriers* – by, Herbert Engineering Corp – SNAME Joint Northern California Section and ASNE Meeting December 1978.

Lloyd, A., R., J., M. 1998. *Seakeeping, Ship Behaviour in Rough Weather*, 1998, ISBN 0-9532634-0-1

L.J.Le Mesurier and H.S. Humphreys. 1935. *Design and Construction of Merchant Ships*. NEC IES

Psaraftis, H.N., Kontovas, C.A., 2010. *Balancing the economic and environmental performance of maritime transport*. Transport. Res. Part D 15, 458–462.

Psaraftis, H.N. and C.A. Kontovas, *Speed models for energy-efficient maritime transportation: A taxonomy and survey*. Transportation Research Part C: Emerging Technologies, 2013. **26**: p. 331-351.

Rodrique, J.-P., Comtois, C., Slack, B. 2016. *The Geography of Transport Systems*, 4th Edition– Routledge

Silverleaf, A., Dawson, J., 1966. *Hydrodynamic design of merchant ships for high speed operation*. Summer meeting in Germany 12th – 16th of June, 1966. The Schiffbau-technische Geschaft E.V, The institute of engineers and shipbuilders in Scotland, The North East Coast Institution of Engineers and shipbuilders, The Royal institution of naval architects.

Smith et al. (2014). *The Third IMO GHG Study*.Imo.org

Stokseth, B. 1992. *Open-Hatch Bulk Shipping SNF* – Report NO 56/1992. Bergen. Norway

Stopford, M. 2009. *Maritime Economics* 3rd edition. 2009. Oxon: Routledge

Stott, P., Wright, P., 2011. *Opportunities for improved efficiency and reduced CO2 emissions in dry bulk shipping stemming from the relaxation of the Panamax beam constraint*. Trans RINA, Vol. 153. Part A4, Intl J Maritime Eng. Oct-Dec 2011

Thomas P.N. *British Ocean Tramps*. Wayne Research Publications ISBN 0905184