

DOI: 10.18462/iir.gl2022.0105

## Evaluation of cold thermal energy storage in fishing vessels

Erling VINGELSGÅRD<sup>(a)</sup>, Eirik Starheim SVENDSEN<sup>(a)</sup>, Kristina N. WIDELL<sup>(a)</sup>, Tom Ståle NORDTVEDT<sup>(a)</sup>

(a) SINTEF Ocean, Postboks 4762 Torgarden, 7465 Trondheim, Norway, [Erling.Vingelsgard@sintef.no](mailto:Erling.Vingelsgard@sintef.no)

### ABSTRACT

Depending on the operational mode, fishing vessels and fish transporting well-boats have varying cooling demands. There is a possible benefit of peak shaving and energy saving with the use of cold thermal energy storage (CTES), which has been explored in this paper. Fishing vessels have limited space availability and the focus is therefore on compact and efficient systems. A CO<sub>2</sub> system is suitable for that purpose due to its compactness and high volumetric refrigeration capacity. One application is to use ice slurry systems, which can be used to reduce the storage temperature of the fish and thereby keep the fish quality longer, compared with no chilling or chilling in refrigerated seawater (RSW). The chilling rates are faster and there is no significant damage to the fish surface. In this study, theoretical calculations were conducted to find the requirements of an ice slurry system according to the reference conditions of the studied case. The calculation model was built using the thermodynamic properties of ice and fish.

Keywords: Marine refrigeration, Energy consumption, Cold thermal energy storage, Peak power requirements

### 1. INTRODUCTION

The fishery sector consists of many players from catch to table, and the largest user of fossil fuels in the fishery sector is the fishing vessels during the capture (FAO, 2015). Even though the greenhouse gas emission (GHG) in fuel consumption and refrigeration leakage is low per kg of landed fish (Gabriellii and Jafarzadeh, 2020), there is potential for improvements. The simplest way to reduce the GHG would be to electrify the fishing vessel fleet. However, the transition would not be realistic with current battery technology. The operation of the vessels requires a lightweight, dense fuel with the capacity for long trips. Therefore, reducing fuel consumption is one of the most critical steps the fishery sector could make to reduce its climate footprint. The refrigeration systems onboard fishing vessels use electricity produced in the engine, thus indirectly fossil fuels, but limiting the use of the refrigeration system is not suitable since refrigerating fish is essential to preserve the quality. (Nordtvedt and Widell, 2020, 2019; Widell et al., 2021)

The cooling demand will vary from boat to boat and trip to trip. Operating the system according to the design parameters is difficult due to the unpredictable nature of fishing. Weather, catch size, and cooling demand are some of the factors that can result in inefficient use of the refrigeration system. These factors and the system design of the refrigeration system make the system run on part load, which results in unnecessary GHG emissions. It has been observed that for a larger part of the fishing cruise, the refrigeration system is operating far from the optimal or design points (Svendsen et al. 2021), and there is a potential for improvements. Data from that paper has been used in this study to put the research into a more realistic setting. The refrigeration system uses ammonia, which is common onboard Norwegian fishing vessels. The risks of this refrigerant are handled with good safety procedures, resulting in safe and efficient systems with high cooling capacity. During the last decade, it has also become more common with CO<sub>2</sub> as refrigerant, which is non-toxic and non-flammable (Hafner et al., 2019; Semaev et al., 2021; Widell et al., 2016).

One possible solution to counteract the part-load operation is integrating or utilising cold thermal energy storage (CTES). CTES could assist the refrigeration system by reducing the high loads by discharging stored energy (Selvnes et al., 2021). It would be charging cold during low loads, giving the refrigeration system leeway. Hafner et al. (2011) analysed the potential of a CTES applying an indirect CO<sub>2</sub> system in a tunnel freezer. The results showed a 30% lower electricity consumption compared to a system without CTES.

This paper explores alternatives of using ice and ice slurry as cold thermal storage onboard a fishing vessel and the possible advantages.

## 2. OVERVIEW OF CTES SYSTEMS ONBOARD FISHING VESSELS

There are mainly three possible ways to store thermal energy: chemical, sensible, and latent heat storage. Chemical heat storage use adsorption, which is a reversible reaction, to charge and discharge the material to store thermal energy (Alva et al., 2018). This is a promising technology but is still in the laboratory stage, and commercial applications need further research. Hence, chemical heat storage will not be further discussed.

### 2.1. Using (pure water) ice as CTES

The most common use of thermal energy storage in small fishing vessels without mechanical refrigeration is in the form of ice. The most widespread method for small fishing vessels is to bring ice from shore in isolated boxes. The fish is put on ice when caught, or the ice could be mixed with seawater to create chilled seawater (CSW). The heat transfer rate by only using ice is limited due to the air between the ice and the product (Laguerre et al., 2018). The solid ice creates small air pockets, which will work as isolation due to air's low heat transfer coefficient. Crushed ice will reduce the air gaps and increase the surface contact. Using CSW will increase the heat transfer by replacing the air with water (Margeirsson and Arason, 2008). However, the water added also must be chilled, which adds extra heat load. Consequently, more ice is required compared to using only ice. Other limitations with this way of operating are the space limitation onboard and the temperature will increase when the ice has melted.

Another way to utilise ice as CTES is to produce ice in an icemaker onboard (Shawyer and Medina Pizzali, 2003), see an illustration of possible system design in Figure 1. This configuration could distribute the peak refrigeration loads by making ice during low chilling demand periods and supplementing with ice when the chilling tank loads are high. This system requires some extra components, mainly a separate ice maker, crusher, and storage for the ice before use.

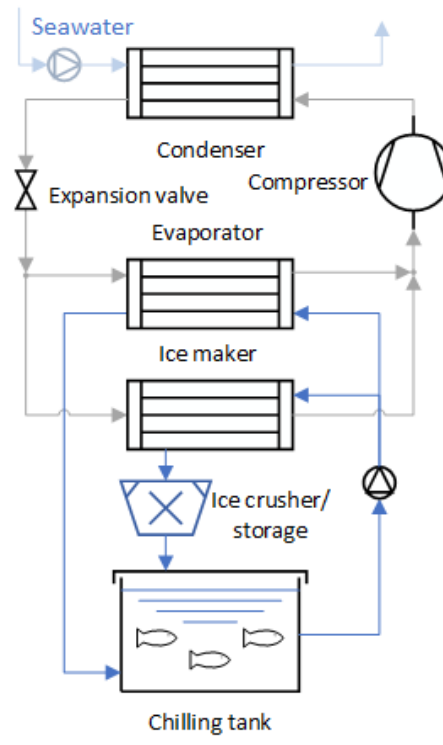

Figure 1: Illustration of refrigeration system with ice maker

## 2.2. Using RSW as CTES

RSW is a sensible thermal energy storage, where seawater is chilled down in large tanks to the lowest feasible temperature ( $0^{\circ}\text{C}$  towards  $-1.9^{\circ}\text{C}$ ), as shown in Figure 2, before the fish is brought on board (Thorsteinsson et al., 2003). The catch temperature is higher than the temperature in the tank, so when the fish is pumped onboard, the temperature in the tank will increase. As a result, the refrigeration system will start to cool down the seawater in the tank again.

The ratio between fish and water in the RSW tank is important for the mixing temperature. Too much fish will reduce the amount of water flowing between the fish, thus reducing the heat transfer and increasing the cooling time (Digre et al., 2016). In some cases, the fish will lump together and the heat transfer will reduce drastically, which will influence the quality. The lumping happens for certain types of fish and has been solved by adding acetic acid (Nordtvedt and Widell, 2019).

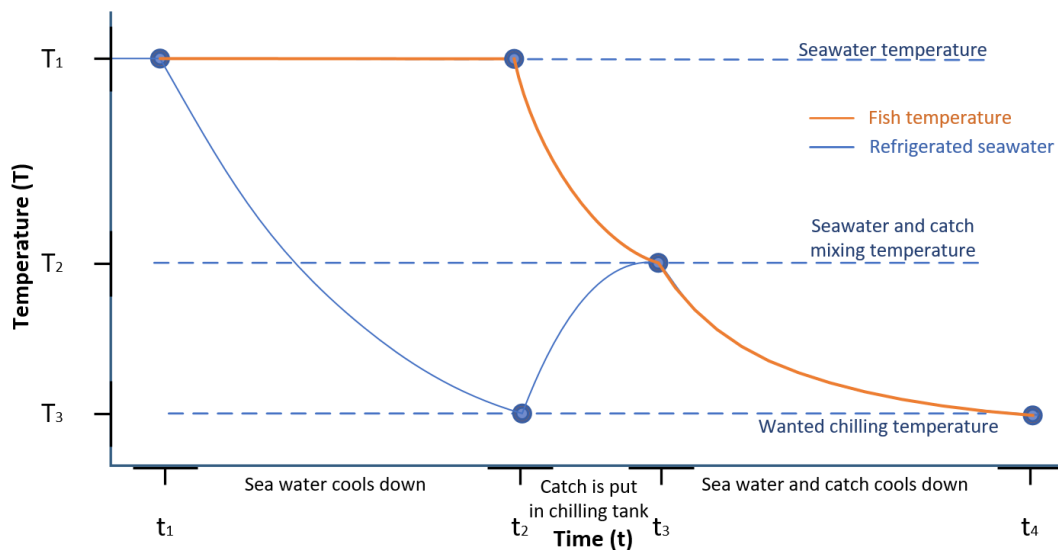

Figure 2: Temperature profile in a RSW tank throughout the cooling process

## 2.3. Ice slurry as CTES

Ice slurry is a mixture of liquid and ice. The slurry could be pure water or a binary solution for a lower freezing point. Sodium chloride ( $\text{NaCl}$ , salt) is the most relevant for direct contact with fish. There is a risk of salt uptake in the fish when the slurry contains salt and this must be considered before using it.

In the ice slurry, there are many microscopical spherical ice crystals mixed with the liquid, thus the slurry appears liquid while some of the liquid has become solid (Melinder and Ignatowicz, 2015). This property is favourable for a working fluid for cooling applications. Due to the latent heat of ice, ice slurry stores more cold than RSW in the same volume. And it could be handled as a liquid, thus be pumped and moved around without clogging the pipes.

Unless the ice slurry is used at the same rate as produced, the system requires a storage tank that stores the ice slurry (Wang and Kusumoto, 2001). This tank is the CTES in the system. In Figure 4 is the storage tank has divided into a poor and rich layer of ice slurry. The system requires either a separate mixing device or a stir in the storage tank to ensure the proper mixing ratio of ice and water in the ice slurry. The easiest use of ice slurry is to bring it from land. The system consists of only two parts: a storage tank and a mixing device, as shown in Figure 3. A significant advantage with a system like this compared to ice brought from land is the reduced manual handling of the ice slurry. The mixing device could pump the ice slurry to different tanks and easily distribute it evenly. This system is mostly relevant for small fishing vessels without an existing refrigeration system.

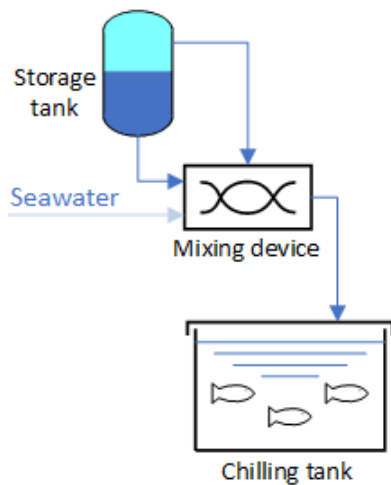

Figure 3: Simplified ice slurry system

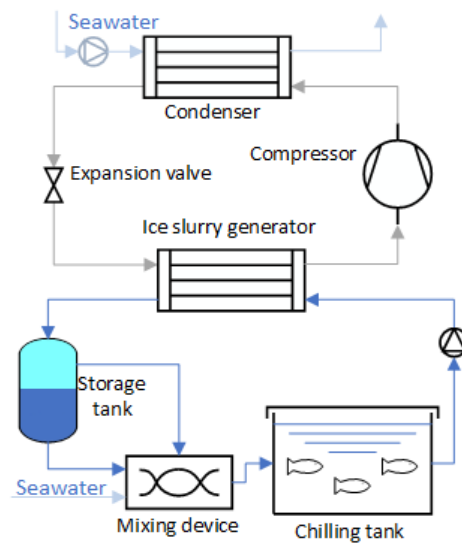

Figure 4: Onboard ice slurry production

### 3. METHODS

To investigate the potential of integrating a cold thermal storage onboard, a baseline case was constructed based on field measurements from a conventional RSW system, and that was compared with three CTES systems:

Case 1) adding ice in RSW tanks during loading of catch

Case 2) adding ice slurry in RSW tanks during a large catch

Case 3) using ice slurry for maintenance cooling

The conventional RSW system was onboard a fishing vessel described by Svendsen et al. (2021), where measurement and system data were used in this study. The fishing vessel was equipped with two separate 1020 kW NH<sub>3</sub> refrigeration systems together with a refrigerated seawater system.

Figure 5 shows the average seawater temperature in one of the fish holding tanks for two trips for the purse seiner, from when seawater cool-down is initiated until the harbour is reached. The characteristics of the two trips are very similar, while the sequence of events is shifted on the time scale, where the characteristics from Figure 2 are recognised. The cool-down period of seawater starts in a reasonable time before the fishing vessel reaches the fishing ground. From Figure 5, the cool-down period lasts for slightly over 12 hours. The start temperature of the seawater is about 15°C, and after 12 hours, the temperature is about -1.5°C. The RSW system is turned off, and the temperature starts to rise slightly due to heat ingress.

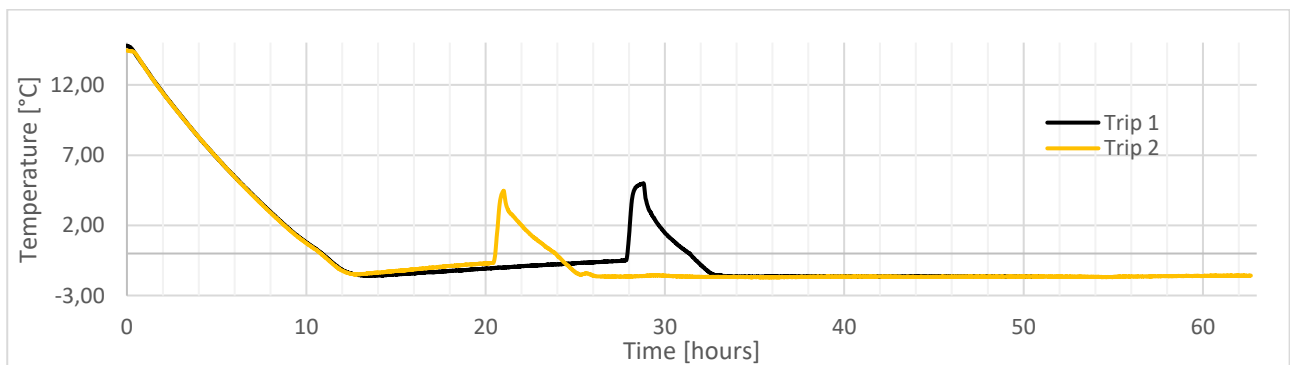

Figure 5: Average temperature profile in a RSW tank for the whole trip

For trip 1 is the catch brought onboard 28 hours after the chilling period started, while for trip 2 is the catch brought onboard after 20 hours. Figure 6 shows the seawater temperature profile for trip 1 during the temperature peak (hour 28 to hour 33). The pumping of fish into the tanks lasts for about 40 minutes and there is an intermission period before the RSW system is turned on again, because of operational constraints related both to the RSW system and the fish. The temperature in the tank rises sharply during this period and reaches equilibrium at around 5°C. The catch size for this trip was 175 m<sup>3</sup> (187.6 tonnes). The temperature decreases rapidly after the RSW system is started. It takes almost 4 hours for the catch to cool down to the desired temperature (-1.5°C). After hour 32, the RSW system runs on part load to maintain the temperature until the fishing vessel returns to land for unloading.

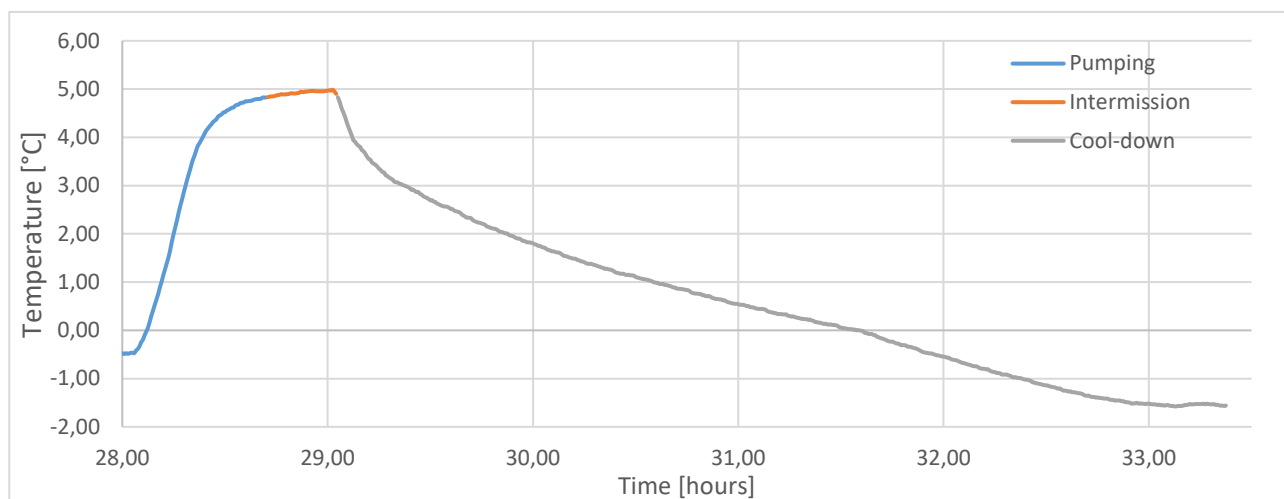

Figure 6: Average temperature profile during loading and initial chilling for trip 1

The three cases which were evaluated in the present study are described here:

### 3.1. Case 1 – Medium catch and pure ice

The first case explored the effect on the temperature in the tank by supplying pure ice to the tank under the same conditions as the baseline case, i.e. 175m<sup>3</sup> mackerel and 354m<sup>3</sup> seawater. The period investigated is during pumping, intermission, and initial chilling to -1.5°C, as shown in Figure 6. The amount of ice added for the calculation was 0m<sup>3</sup>, 10m<sup>3</sup>, 20m<sup>3</sup>, and 29.5m<sup>3</sup>.

### 3.2. Case 2 – Large catch and ice slurry

In case 2, the filling ratio increased to about 66%, i.e. 350m<sup>3</sup> fish and 179m<sup>3</sup> seawater. Also, the pure ice is replaced with ice slurry. The initial temperature of the tank and ice slurry is -1.92°C, and the ice fraction in the ice slurry is 0%, 10%, 20%, 30% and 40%. The calculations done for case 1 and 2 are the same.

### 3.3. Case 3 – Maintenance cooling and ice slurry

The third case looked at the maintenance cooling of the fish on the trip back to land. Results from Svendsen et al. (2021) show that the refrigeration system had to run on part load operation (with low performance, i.e. COP) to maintain a temperature around -1.5°C. Case 3 explores how an ice slurry system could operate to counter the heat ingress and maintain a low temperature of the catch.

### 3.4. Calculations

The cooling process of fish is a complex transient process, but steady-state calculations can give a good overview of the refrigeration effect of different alternatives. In this study, steady-state calculations were conducted to explore the effect of introducing ice or ice slurry to the cooling and the effect on cooling time and energy consumption. Calculation of the cases was conducted in Excel. The fish tanks were combined into

one large unit, and steady-state calculations were conducted for each time step. Data from the baseline case was water temperature.

In the baseline case, the RSW system was started after the pumping and intermission period, which lasted for about one hour. It was assumed that the seawater and the fish had the same temperature after one hour to simplify the calculations. Figure 6 shows a rapid temperature change in the first 0.5 hours, from which we can assume that most of the heat available in the fish has already been transferred to the water. Eliasson et al. (2021) measurements of ungutted cod also show that a large part of the heat is transferred in the first 0.5 hours.

Pure water was assumed in the case 1 calculation. The freezing point is 0°C and the latent heat of ice is 334 kJ/kg. The latent cold stored in the ice is given in Eq. 1.

Seawater was used in the ice slurry calculations. The salt concentration of seawater is ≈3.5 wt-% which gives a freezing point of -1.92°C (Melinder and Ignatowicz, 2015). The ice concentration in ice slurries is limited to a maximum of 60% to avoid problems with clogging.

$$Q_{latent} = m \cdot \Delta h = V \cdot \rho \cdot \Delta h [kW] \quad \text{Eq. (1)}$$

The specific heat of seawater and fish (mackerel) was calculated with a reference temperature of 0°C. The  $c_{p,seawater}$  is 3,994 kJ/kg,  $c_{p,fish}$  is 3,336 kJ/kg,  $\rho_{seawater}$  is 1027,3 kg/m<sup>3</sup>, and  $\rho_{fish}$  is 1072 kg/m<sup>3</sup>.

$$Q = m \cdot c_p \cdot (T - T_{ref}) = V \cdot \rho \cdot c_p \cdot (T - T_{ref}) [kW] \quad \text{Eq. (2)}$$

For the calculations, mass and heat balances were used to calculate the temperature profile and energy requirements. The heat loss was estimated from the baseline case on the trip back.

## 4. RESULTS AND DISCUSSION

### 4.1. Case 1 – Medium catch and pure ice

Figure 7 shows the effect of adding ice to the tank before the fish is brought onboard. The baseline case of a conventional RSW system is shown in black, and the calculated temperatures with the same conditions are shown in blue. There is a temperature deviation between the equilibrium temperature of the baseline case and calculated temperatures around hour 1. This could originate from heat loss not considered, i.e. pumping, movement of the fish, or the placement of the temperature loggers. The loggers may be exposed to higher temperatures due to limited water circulation in the tank during the pumping and intermission phase. The pumping system is required to move water between other tanks, which results in the temperature of the water heating up uneven.

Although the temperature profile of the black and blue lines do not have the same characteristics for all time steps, the equilibrium temperature and the cool-down time match. The reduction in the baseline case is larger at the beginning of the cool-down period, while it flattens out and ends up with a tail that approaches -1.5°C. The tail is due to the small temperature difference between the seawater and the fish because the RSW system could not produce any colder water without freezing it. The cool-down times for the different alternatives are summarised in Table 1.

The difference in cool-down time between the baseline case and 0m<sup>3</sup> ice added is 0.3 hours (18 minutes), while the time reduction between the 0m<sup>3</sup> ice added and 10m<sup>3</sup> ice added is about 0.9 hours (54 minutes), which is the same time reduction time for each 10m<sup>3</sup> added. For the given values of the fish and seawater, about 29.5 m<sup>3</sup> ice is required to reach an equilibrium temperature of 0°C. The RSW system uses 0.92 hours (55 minutes) to reduce the temperature to -1.5°C.

The assumption of a temperature equilibrium after one hour depends on the circulation of the water, especially when ice is added. Ice floats and without circulation will the temperature difference in the tank be

large. Consequently, the assumption of equilibrium after 1 hour for larger amounts of ice will be questionable. However, after the RSW system is turned on, the circulation in the tank will increase and the ice will melt faster. Another benefit of adding ice is the increased temperature difference between the fish and water. A larger temperature difference will increase the heat transfer, thus reducing the cool-down time.

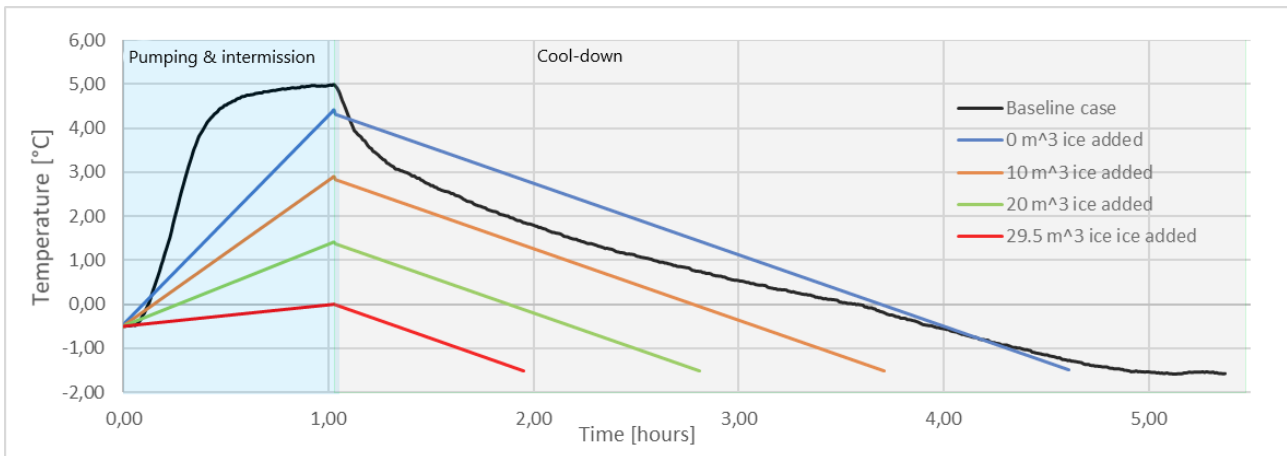

Figure 7: Average temperature profile during pumping, intermission, and initial cool-down

Table 1 Volume, temperatures, and cool-down time affected by adding ice

	Volume [m <sup>3</sup> ]	T <sub>initial</sub> [°C]	T <sub>equilibrium</sub> [°C]	Cool-down period [hour]
<b>Fish</b>	<b>175</b>	<b>15</b>	–	–
<b>Seawater</b>	<b>354</b>	<b>-0.5</b>	–	–
<b>Baseline case</b>	–	–	<b>5</b>	<b>3.88</b>
<b>Ice</b>	<b>0</b>	–	<b>4.3</b>	<b>3.58</b>
<b>Ice</b>	<b>10</b>	<b>0</b>	<b>2.9</b>	<b>2.68</b>
<b>Ice</b>	<b>20</b>	<b>0</b>	<b>1.4</b>	<b>1.78</b>
<b>Ice</b>	<b>29.5</b>	<b>0</b>	<b>0.0</b>	<b>0.92</b>

#### 4.2. Case 2 – Large catch and ice slurry

In case 2, the amount of fish was increased to 350m<sup>3</sup>, see Table 2 Volume, temperatures, and cool-down time affected by adding ice slurry for other given values. The increased catch will result in an increased heat load from the fish, thus the equilibrium temperature for 0% ice concentration (i.e., pure RSW) (8.8°C) is higher for case 2 than 0m<sup>3</sup> ice added (4.3°C) in case 1. The cool-down time for alternative 0% ice concentration was 6.36 hours, while the cool-down time for 10% ice concentration was 4.56, which is a decrease of 1.8 hours. Further increasing the ice concentration reduces the cool-down time linearly. For 30% ice concentration is the equilibrium temperature slightly below 0°C.

The calculations show that the amount of latent cold stored in the ice slurry was equal to the amount of heat in the fish at an ice concentration of 36.3%. That is, the equilibrium temperature is -1.92°C, so the RSW system does not need to be turned on for the cool-down period. For ice concentration above 36.3%, the ice slurry will have remaining ice in the slurry after the cool-down period. Thus will the excess ice maintain the low temperature against heat ingress. For the 40% ice concentration, the extra cold will maintain the temperature in the tank for 6.5 hours. Consequently, the cool-down time of the fish will be fully dependent on the transfer rate from the fish to the ice slurry and not the heat removal rate of the RSW system.

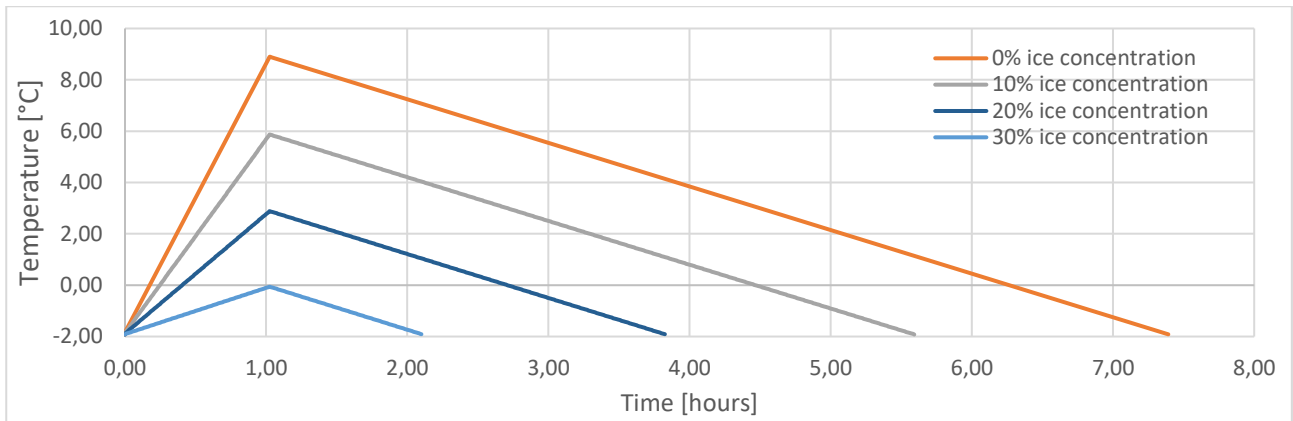

Figure 8: Average temperature profile during pumping, intermission, and initial cool-down with ice slurry

Table 2 Volume, temperatures, and cool-down time affected by adding ice slurry

	Volume [m <sup>3</sup> ]	T <sub>initial</sub> [°C]	T <sub>equilibrium</sub> [°C]	Cool-down period
<b>Fish</b>	<b>350</b>	<b>15</b>	–	–
<b>Seawater</b>	<b>179</b>	<b>-1.92</b>	–	–
<b>Ice concentration 0%</b>	–	<b>-1.92</b>	<b>8.8</b>	<b>6.36</b>
<b>Ice concentration 10%</b>	–	<b>-1.92</b>	<b>5.8</b>	<b>4.56</b>
<b>Ice concentration 20%</b>	–	<b>-1.92</b>	<b>2.8</b>	<b>2.79</b>
<b>Ice concentration 30%</b>	–	<b>-1.92</b>	<b>-0.2</b>	<b>1.07</b>
<b>Ice concentration 40%</b>	–	<b>-1.92</b>	<b>-1.92</b>	–

### 4.3. Case 3 – Maintenance cooling with ice slurry

In the baseline case, the tank reaches the desired temperature after about 5 hours for the measured temperature, as seen in Figure 6: Average temperature profile during loading and initial chilling for trip 1. For the remaining part of the trip (about 17.5 hours), the only heat load on the RSW system is heat ingress from the surroundings. The blue graph in Figure 9 shows the heat load calculated from the baseline case after the catch is brought on board. The cold produced after hour 5 is to maintain the water temperature in the tank. It is relatively steady with some periods with lower loads. The heat ingress can be found by estimating the average cold production in this period. The average heat loss was 82 kW and is shown in red in Figure 9. Running the RSW system at a low capacity is inefficient, and replacing the continuous operation of the RSW system with added ice or ice slurry may save fuel. The green graph in Figure 9 shows how long an ice slurry system producing 1020 kW of cold has to run to cover the cold requirements for the trip back. Producing ice slurry in 1.4 hours will store enough cold in the form of ice slurry. Therefore, the refrigeration system could be turned off for the rest of the trip.



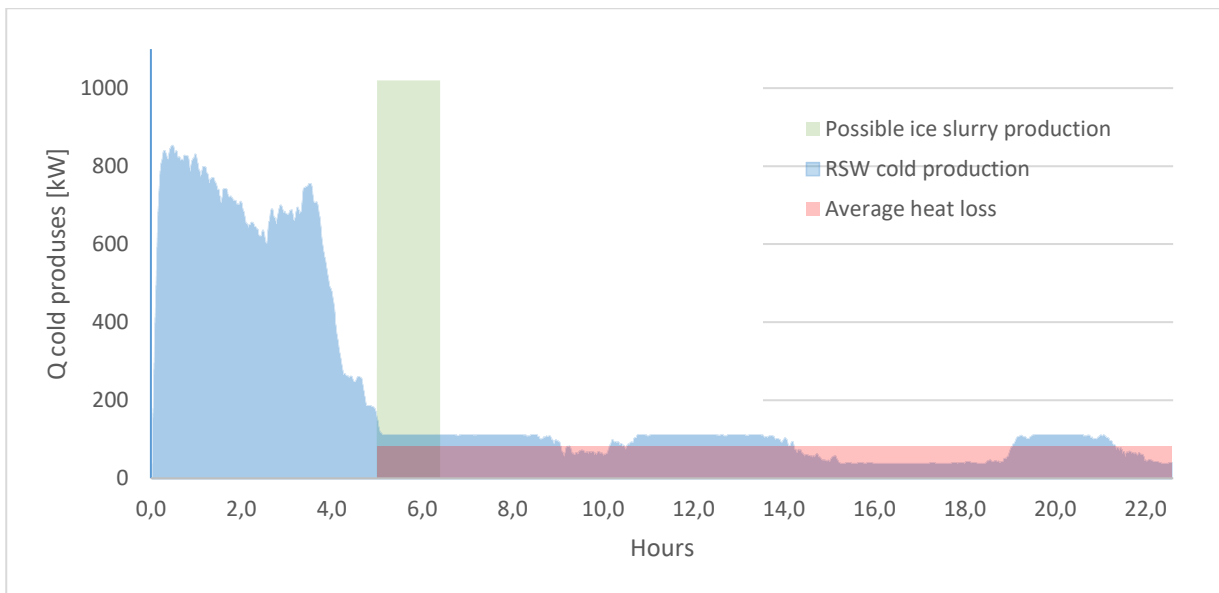

Figure 9: Heat losses on the way back

The total cold production by the RSW system, from the fish was brought onboard to the fish was unloaded, was about 4500 kWh for trip 1. Assuming the ice slurry is brought from land, would 200m<sup>3</sup> of ice slurry with a 60 % ice concentration contain 5890 kWh latent cold. By bringing the ice slurry from land, additional heat losses will be added on the trip to the fishing grounds. For trip 1, the travel time is 28 hours, and assuming the average heat loss as in Figure 9, the heat load for the entire trip will increase from 4500 kWh to 6715 kWh. Consequently, 228m<sup>3</sup> of ice slurry with a 60 % ice concentration would be needed to cover the cooling need.

Some may point out that adding mass in the form of ice or ice slurry to the tank from land would increase the fuel consumption for propulsion, which is correct. However, seawater cooling starts early on the trip, so a similar amount of mass is already pumped onboard for almost the whole trip. On the contrary, it would require less mass in form of ice for the same amount of cold stored.

## 5. CONCLUSION AND FURTHER WORK

This study has evaluated ice and ice slurry as additions to a conventional RSW system. Data and system description from a previous study was used as reference. This system was compared with three cases, where case 1 shows the addition of pure ice could reduce the cool-down time 54 minutes pr 10m<sup>3</sup> ice added. The second case looks at a larger catch of fish, and the ice is replaced with ice slurry made from seawater. With a concentration of 36.3% ice in 179m<sup>3</sup> of seawater, will the latent cold stored be equal to the amount of heat necessary to remove from 350m<sup>3</sup> fish. One of the main advantages of adding ice or ice slurry is to utilise the period during pumping and intermission. Currently, the only cooling of the fish during this period is by the mixing of non-circulated, pre-chilled seawater in the tank and warm fish. The RSW-system is not turned on since the piping is used for pumping water between tanks. The cold stored as sensible cold in the seawater is limited, which leaves room for an unexploited cooling period. Case 3 examines the potential of using ice slurry as cold thermal storage to maintain the temperature in the tank on the trip back from fishing grounds. The calculations show it is sufficient to run the ice slurry system for 1.4 hours on full load instead of 17.5 hours on part load.

This work shows potential for utilising ice and ice slurry to assist the RSW refrigeration system onboard fishing vessels. Fishing with purse seiner and trawlers experiences large catches of fish brought onboard at the same time, which should be cooled down as fast as possible. Over-dimensioning a refrigeration system can lead to part-load operation and low efficiency for parts of the fishing cruise and that should be evaluated. The

seafood industry is an important player to meet future food demand. However, refrigeration systems are required to ensure the quality and safety of the food, and the cooling process is an energy-intensive process. Hence, focusing on natural refrigerants and energy reduction - consequently reducing GHG emissions - is one of the most important steps the fishery sector could take to reduce its climate footprint.

A fishing vessel has limited space to install new equipment, so introducing ice or ice slurry systems should be carefully evaluated before implementation. Using ice is challenging due to the manual handling. Adding ice from land may be the most practical use of pure ice since the ice could be added in the tank and then would not need any additional handling onboard, but this solution will limit the flexibility of moving ice between tanks. The utilisation of ice slurry is more promising, both the possibility of bringing it from land and producing it onboard.

In further work, it would be interesting to analyse more potential cases, also with CTES integrated into a CO<sub>2</sub> refrigeration system, as described by Hafner et al. (2011). A transient analysis, including the cooling rate of fish, could also result in an even better understanding of the temperature profile. The quality of the fish and the effect the temperature has on it has not been analysed here and should be analysed in further work. That also includes evaluating the mechanisms (regulatory, political, technical) that gives the fishing vessels incentive to keep the temperature of the catch low and stable.

Producing ice or ice slurry requires a lower temperature in the evaporator, which will increase the energy consumption of the refrigeration system. However, the user has more flexibility to decide when to use it and avoid part-load operations. Calculating the optimal operation of an ice slurry system and comparing it to a conventional one may highlight the possibility of utilising ice slurry to a more significant degree.

## ACKNOWLEDGEMENTS

The authors gratefully acknowledge the Research Council of Norway for the financial support for carrying out the present research [NFR project No. 257632, HighEFF and NFR project No. 294662, CoolFish].

## NOMENCLATURE

Q	Energy [kW]	$\Delta T$	Temperature difference [K]
V	Volum [m <sup>3</sup> ]	$\rho$	Density [kg m <sup>-3</sup> ]
$c_p$	Specific heat [kJ kg <sup>-1</sup> K <sup>-1</sup> ]	$m$	Mass [kg]

## REFERENCES

- Alva, G., Lin, Y., Fang, G., 2018. An overview of thermal energy storage systems. Energy. <https://doi.org/10.1016/j.energy.2017.12.037>
- Digre, H., Tveit, G.M., Solvang-Garten, T., Eilertsen, A., Aursand, I.G., 2016. Pumping of mackerel (*Scomber scombrus*) onboard purse seiners, the effect on mortality, catch damage and fillet quality. Fish. Res. 176, 65–75. <https://doi.org/10.1016/j.fishres.2015.12.011>
- Eliasson, S., Ragnarsson, S.O., Arason, S., Margeirsson, B., Palsson, O.P., 2021. Onboard pre-chilling of ungutted and gutted Atlantic cod in different cooling media -Temperature measurements and analytical modelling-. Int. J. Refrig. 132, 72–81. <https://doi.org/10.1016/j.ijrefrig.2021.08.027>
- FAO, 2015. FAO - FUEL AND ENERGY USE IN THE FISHERIES SECTOR Approaches, inventories and strategic implications.

- Gabrieli, C.H., Jafarzadeh, S., 2020. SINTEF Energy Research Efficient Energy Usage Carbon footprint of fisheries-a review of standards, methods and tools.
- Hafner, A., Gabrieli, C., Widell, K.N., 2019. Refrigeration units in marine vessels, TemaNord. Nordic Council of Ministers, Copenhagen. <https://doi.org/10.6027/TN2019-527>
- Hafner, A., Nordtvedt, T.S., Rumpf, I., 2011. Energy saving potential in freezing applications by applying cold thermal energy storage with solid carbon dioxide. *Procedia Food Sci.* 1, 448–454. <https://doi.org/10.1016/j.profoo.2011.09.069>
- Laguerre, O., Derens, E., Flick, D., 2018. Modélisation du refroidissement du poisson à l'aide de glace écaillé. *Int. J. Refrig.* 85, 97–108. <https://doi.org/10.1016/j.ijrefrig.2017.09.014>
- Margeirsson, B., Arason, S., 2008. Comparison between different ice media for chilling fresh fish. *CCM 2008 3rd Int. Work. Cold Chain Manag.* 5.
- Melinder, A., Ignatowicz, M., 2015. Properties of seawater with ice slurry use in focus. *Int. J. Refrig.* 52, 51–58. <https://doi.org/10.1016/j.ijrefrig.2014.12.022>
- Nordtvedt, T.S., Widell, K.N., 2020. Refrigeration and sustainability in the seafood cold chain, in: *Refrigeration Science and Technology. International Institute of Refrigeration*, pp. 13–24. <https://doi.org/10.18462/iir.iccc.2020.314814>
- Nordtvedt, T.S., Widell, K.N., 2019. Chilling of pelagic fish onboard Norwegian fishing vessels, in: *25th IIR International Congress of Refrigeration. IIR, Montreal, Canada.* <https://doi.org/10.18462/iir.icr.2019.0305>
- Selvnes, H., Allouche, Y., Manescu, R.I., Hafner, A., 2021. Review on cold thermal energy storage applied to refrigeration systems using phase change materials. *Therm. Sci. Eng. Prog.* <https://doi.org/10.1016/j.tsep.2020.100807>
- Semaev, P., Söylemez, E., Tolstorebrov, I., Hafner, A., Widell, K.N., Lund, T., Øy, J., Petter URKE, J., 2021. Simulation of a carbon dioxide (R-744) refrigeration system for fishing vessel, in: *9th IIR Conference: Ammonia and CO2 Refrigeration Technologies. Ohrid, N. Macedonia.* <https://doi.org/10.18462/iir.nh3-co2.2021.0022>
- Shawyer, M., Medina Pizzali, A.F., 2003. *The use of ice on small fishing vessels.*, FAO. Fisheries Technical Paper.
- Svendsen, E.S., Norne, K., Ståle, T., Jafarzadeh, S., Gabrieli, C., 2021. Energy consumption of ammonia refrigeration system on board a fishing vessel, in: *9th IIR Conference: Ammonia and CO2 Refrigeration Technologies, Ohrid, 2021.* pp. 129–138.
- Thorsteinsson, J.A., Condra, T.J., Valdimarsson, P., Jensson, P., 2003. Transient simulation of refrigerated and chilled seawater system, in: *Proceedings of the 44th Conference on Simulation and Modelling.*
- Wang, M.J., Kusumoto, N., 2001. Ice slurry based thermal storage in multifunctional buildings. *Heat Mass Transf. und Stoffuebertragung* 37, 597–604. <https://doi.org/10.1007/PL00005891>
- Widell, K.N., Nordtvedt, T.S., Eikevik, T.M., 2016. Natural refrigerants in refrigerated seawater systems on fishing vessels, in: *12th IIR Gustav Lorentzen Natural Working Fluids Conference.* pp. 933–940. <https://doi.org/10.18462/iir.gl.2016.1156>
- Widell, K.N., Tveit, M.G., Gabrieli, C., Cowan, E., Grimsmo, L., Svendsen, E.S., 2021. Equipment and systems onboard fishing vessels Fishing vessels, equipment, handling, and processing, including cooling, freezing, and heating.