

DOI: 10.18462/iir.nh3-co2.2021.XXXX

R744 Refrigeration Solution for Small Supermarkets

Simarpreet SINGH^(a), Ángel Álvarez PARDIÑAS^(b), Armin HAFNER^(a),
Christian SCHLEMMINGER^(b), Krzysztof BANASIAK^(a)

^(a)Norwegian University of Science and Technology,
Trondheim-7491, Norway
^(b)SINTEF Energy Research,
Trondheim-7034, Norway

ABSTRACT

Application based technology solution is nowadays preferred to achieve the performance of the cooling system configuration at its best. Therefore, benchmarking is an essential criterion which would add value to the optimum system design for various applications. In this study, a case study is carried out for a Milk Bar (small supermarket) to evaluate the potential of R744 cooling system for the similar cooling demand and tropical conditions. Field data collected during a particular time and temperature zone is further used to develop a yearly round performance of the HFC plug-in cabinets for MT and LT applications. The data is further used to develop a centralized R744 booster system that would meet the similar cooling load and demand of all the cabinets in the shop. Based on the cooling loads for the HFC unit, the yearly performance of the R774 booster system is calculated and compared to the existing plug-in solution. It is observed that the yearly electric energy consumption for the R744 centralized refrigeration system is 3.3 M W·h, 24% lower than with the existing solution based on HFCs. Moreover, the economic prospective of the R744 is further discussed to alternative material for the components and centralized unit structure which could empower the system with more reliability and an effective substitute to the synthetic technology for smaller supermarkets.

Keywords: Two-phase ejector; R744, Supermarket.

1. INTRODUCTION

Eco-friendly R744 cooling and heating solutions are gaining progressive momentum around the globe in order to reduce the greenhouse gas emission contributing by the HVAC&R sector (Gullo et al., 2018). HVAC&R is an evolving sector with tending to upsurge its penetration at a greater scale to fulfil the increasing demand of the built environment mostly near the tropical regions (Singh et al., 2021). Due to the global warming concern, the energy-saving eco-friendly solution R744 is observed as a vital solution and considered with high business potential, though, greatly dependent on the system cost, electricity price and ambient conditions. The refrigeration market has an elevated scope for the R744 solutions as it supports both medium and low-temperature application essential in the supermarket sector. In the developing countries such as India, the major contribution observed are primarily supermarkets with a majority of scope in small capacity installations (Singh et al., 2020). In order to strategically increase the penetration of the eco-friendly technology, the current trend needs to diverge towards a small supermarkets system which has a better scope (Ali, 2018). However, the foremost challenge associated with the eco-friendly R744 technology for small supermarket capacity system is the bigger market share is presently covered by the synthetic refrigerants (Yari & Sirousazar, 2008). Recent development due to the environmental constraints is getting inclined towards the replacement of synthetic refrigerants with eco-friendly solutions. However, traditional systems have low initial investment cost which made it a more attractive option to adopt. Nevertheless, at elevated ambient temperature conditions, the conventional R744 booster system projects lower energy efficiency values when compared to the well maintained conventional HFC systems.

On the other hand, development of small capacity R744 system is challenging considering the current available system components in the market. Therefore, to promote the energy efficient eco-friendly R744 in developing countries, the overall efficiency and initial cost of the unit should be considered as a primary motive which could be proposed with a conventional system design. Moreover, the heat recovery potential on the high-pressure side of the R744 system offers an additional advantage. The present study focuses on a real installation

in a Milk Bar which utilizes HFC-plug-in display cabinets for cooling and freezing of the milk products. The electric energy consumption, evaporation and condensation temperatures and cooling load of one of the freezing and one of the cooling cabinets were experimentally evaluated under normal Milk Bar operation. The results were used to derive a robust modelling approach to predict yearly cooling demands and electric energy consumption of the Milk Bar. The analysis is further used to design a model of a small centralized R744 booster system (condensing unit) that would meet the similar cooling load and demand of all the cabinets in the shop. Based on the cooling loads for the HFC unit, the yearly performance of the R744 condensing units was calculated and compared to the existing traditional solution.

2. SMALL SUPERMARKET FOR DAIRY PRODUCTS (MILK BAR): A CASE STUDY

The milk plant, Verka, was established in 1963, located at Amritsar in Northern India. The milk bar/factory outlet of the product being an integral part, supports and fulfill the cooling and freezing demand for the stored products. Figure 1 shows the internal structure of the milk bar (top view). The bar is designed in an octagon shape and has seven medium temperature (MT), two low temperature (LT) Visi cooler cabinets maintained at 6 °C and -18 °C temperature, respectively. Due to a limited air conditioning demand in the bar, a 7 kW capacity split unit is installed inside the premises. Table 1 shows the details of the cabinets and air-conditioning in the milk bar.

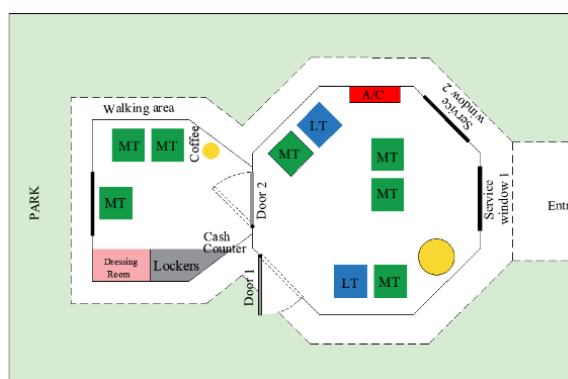



Figure1: Internal structure of the milk bar (top view).

Table 1: Details of the cabinets and air conditioning in the milk bar.

Details	Cabinet	Units	Value/Range
Visi cooler temperature	MT	°C	8
	LT	°C	-19
Split	AC	°C	16 to 26
Model	MT	-	SRC 700
	LT	-	SRF 500
	AC	-	Voltas CZZ 243
Cooling Capacity	MT	Litre/Tons/kW	570/0.68/2.24
	LT	Litre/Tons/kW	465/0.45/1.48
	AC	Tons/kW	2/7
Quantity	MT	-	7
	LT	-	2
	AC	-	1
Refrigerant	MT	-	R134a
	LT	-	R404A
	AC	-	R32





MT



LT

3. REAL TIME FIELD DATA ANALYSIS OF A SMALL SUPERMARKET

This section describes the methodology of the measurements and data collection at the supermarket. The various operating parameters such as Temperature (ambient, condenser outlet, evaporator inlet, cabinet), humidity (ambient, cabinet) and power consumption of the MT and LT cabinet are measured and analysed to

obtain the overall performance of the MT and LT cabinets for a typical day of winter. Details of the measuring sensors used and their location in the MT and LT cabinet are tabulated in Table 2. During the operation, six hours constant manual data logging was carried out with a lap of three minutes. Parametric measurements are collected for a normal day operation with a constant opening and closing of the cabinet doors in the shop. The varying load profile due to the infiltration of air and changing cooling load due to the opening and closing of the cabinet door is considered for the test-campaign to evaluate the max performance of the cabinets to attain the comparative study.

Table 2. Measuring sensors used and their locations in the MT and LT cabinets.

Sensor	Model	Range	Accuracy (% of measure value)	
Temperature	Thermocare PT	-50 °C to 70 °C	±0.5	
Humidity	HTC-RH	0 to 100% RH	±2%	
Power meter	HTC PM-03	0.2 - 1 W/1 - 5 W/5 - 2200 W	<10 / 5 / 1	

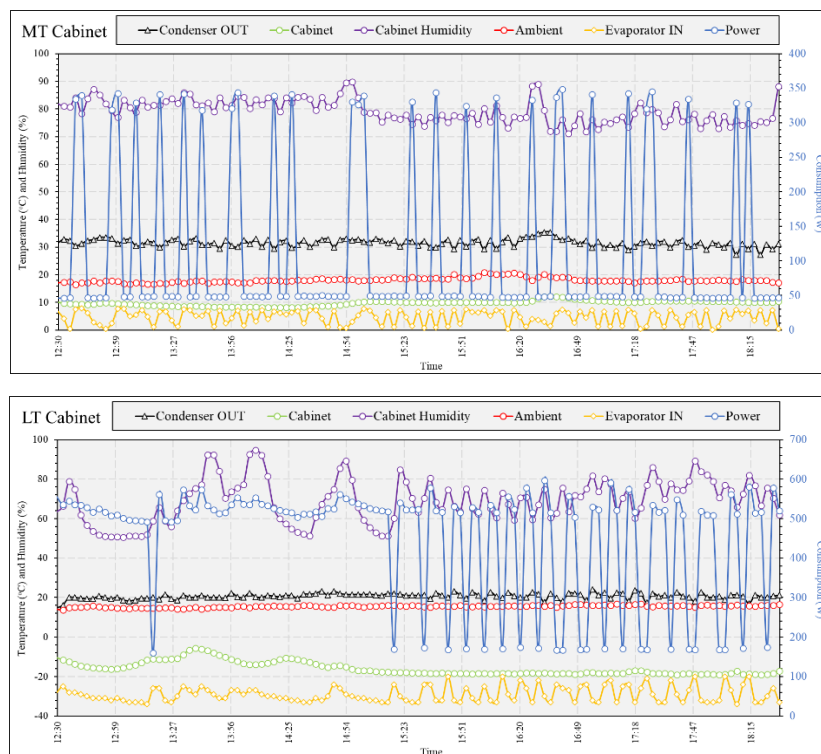

Figure 2: Variation of the operating parameters of the MT and LT cabinet.

Figure 2 shows the variation of the operating parameters of the MT and LT cabinet. A relatively cold day of January with around 17 °C and 15 °C ambient temperatures, respectively. It is observed that, with the continues opening and closing of the MT and LT cabinet door during daytime working operation, the cabinets are able to maintain the air temperatures in the cabinets i.e., 6 °C and -18 °C for MT and LT, respectively. The variation in air humidity inside the cabinet was 50 to 95% throughout the operational period as observed and reason for the same is air infiltration with continues door opening. During the system operation, compressor's switching on/off is continuously logged in relation to the evaporator and cabinet temperature. It is registered that the base load (compressor off) of the MT and LT cabinets are ~40 W and ~180 W, respectively, due to the essential electrical components fixed in both cabinets. The base load is comparatively high in case of LT cabinet due to an additional heater installed in the LT cabinet glass door (inside the jacket) to protect the same from frost formation.

3.1. Evaluation of yearly operation

This section describes the methodology utilized to use the field measurements for the MT and LT cabinets and calculate the yearly electricity consumption associated with the existing HFC-based display cabinets.

Based on the field measurements described in the previous section, it was possible to conclude that the electric energy consumption of the MT and LT cabinets is constant during the days of the test campaigns, with marginal differences between night and day. The electricity consumption was equal to 127 W·h and 468 W·h for the MT and LT cabinets, respectively. Considering the base electricity consumptions mentioned above, the electric energy consumptions of the compressor installed in each cabinet were obtained. The datasheets and technical information of the MT and LT compressors provided by the manufacturer (MT: THK9417YJE of Tecumseh and LT: NEK2150GK of Embraco) were used to firstly confirm the power consumption measured with the compressor in operation (after subtraction of power consumption of auxiliaries) and secondly to evaluate the cooling loads of the cabinet at those operating conditions. The cooling and freezing loads were approximately 265 W·h and 484 W·h, respectively, during the days of the field data measurements, for which the temperature outdoors was relatively low and the air temperature in the shop/supermarket was stable at 17 °C (MT cabinet measurements) and 15 °C (LT cabinet measurements).

The refrigeration loads in the display cabinets depend on the conditions in the shop. Due to the limited availability of field measurements, the open-source computational tool CoolPack (version 1.50 www.ipu.dk), module "Cooling demand equals to Refrigerated display cabinets", was used to determine these refrigeration loads at different air temperatures in the shop, which is in addition the heat rejection source of the condenser of each individual cabinet. Definition of parameters for the calculation tool and the resulting cooling demands at different air temperatures are shown in Figure 3. The refrigeration demand of the MT display cabinet would increase from 191 W to 1.386 kW if environmental (shop) air temperature would range from 15 °C to 40 °C. The same would happen for the LT display cabinet, from 485 W to 1.956 kW. However, the refrigeration systems and compressors installed in each cabinet would not have enough cooling capacity to meet the demand at all conditions. Those marks in red correspond to working conditions at which the compressor would be under dimensioned, i.e., shops need air conditioning to maintain the cooling demand of the display cabinets under control and the quality of the products preserved. In the present study, it was considered that the air temperature in the shop should range between 15 °C and 20 °C, with heating under cold environmental conditions and air conditioning with warmer conditions. Thus, refrigeration loads are restricted to the temperature range 15 °C – 20 °C.

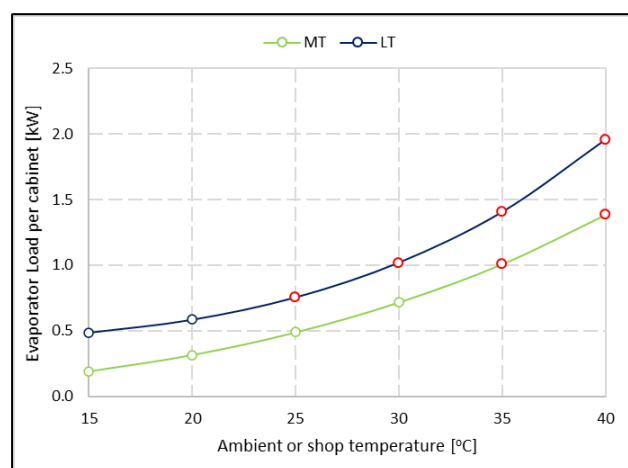

Figure 3. Left, parameters for the definition of the cooling demands in CoolPack. Right, cooling demands for each MT and LT display cabinets under different air temperatures in the surroundings.

The ambient temperatures and relative humidity during a year for the location of the case study (Amritsar) were grouped in temperature bins (5 K) and average humidity for each temperature bin, as depicted in Figure 4. This information was used in a temperature-bin analysis to evaluate the yearly energy consumption due to the refrigeration system in the case study, and the results are presented in another section.

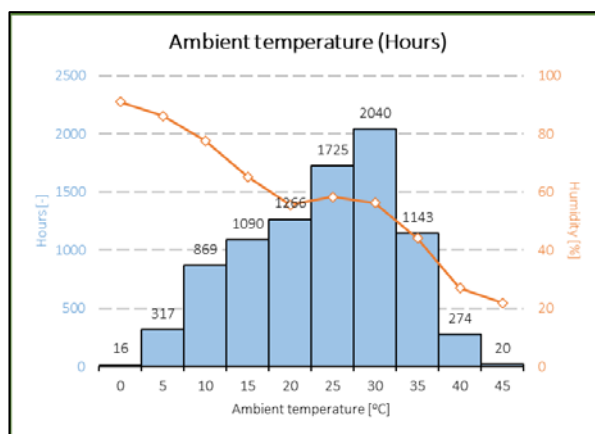

Figure 4: Temperature bins and average relative humidity for each temperature bin in the location of the case study.

4. PROPOSED LOW-COST, SMALL-CAPACITY R744 CONDENSING UNIT

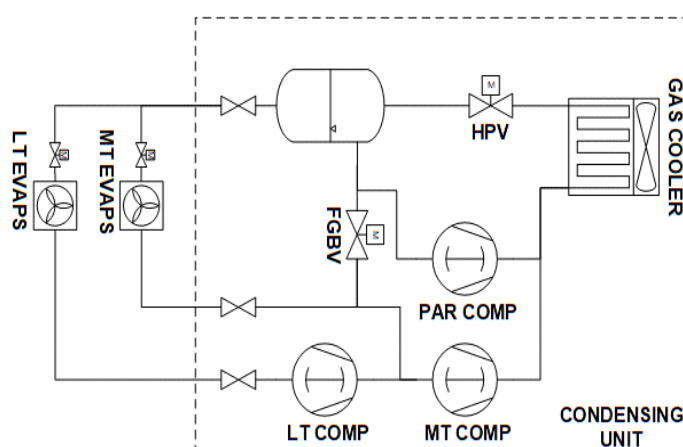

Figure 5: Simplified sketch of R744 condensing unit for the case study.

As an alternative to the existing solution in the case study, a centralized low-cost, small-capacity R744 condensing unit was theoretically devised to supply the evaporators of the display cabinets in the supermarket, as shown in Figure 5. It is based on a parallel compressor supported booster layout, with LT compressor for the freezing cabinets, MT compressor for the cooling cabinets, gas cooler for heat rejection outdoors (not in the shop as in the existing solution), high pressure valve (HPV) to adjust the high-pressure level according to operating conditions, and liquid receiver connected to the evaporators through the liquid line and to the parallel compressor or flash-gas bypass valve (FGBV) through the gas port.

The dimensioning of the compressors was performed according to the refrigeration loads (MT and LT) defined in the previous section and assuming that all MT (7 units) and LT (2 units) display cabinets are identical, i.e., the design load for the centralized R744 unit was equal to 2.21 kW at MT level (0 °C evaporation temperature for additional safety compared to 6 °C in the individual HFC-systems) and 1.17 kW at LT level (-30 °C evaporation temperature). The ambient temperature considered for design was 40 °C, which seems a sufficient value for most locations in the world. As a reminder, the centralized solution using R744 rejects heat outdoors in opposition to the existing units. Considering also that an objective of this study was to "compete" with low-cost, HFC-based display cabinets, the most inexpensive compressors in the market for R744 should be selected. These are typically rotary compressors, in contrast with more expensive reciprocating compressors. In this particular case, three identical units were picked from Toshiba, model DY30N1F-10F (3 cc), of 1-stage compression and equipped with inverter for optimal control of capacity (25 – 100 Hz).

The R744 condensing unit presented was modelled in detail using Modelica object-oriented programming language in Dymola 2021 environment (Dassault Systems, Vélizy-Villacoublay, France). The models developed are based on TIL 3.9 library, and R744 and humid air properties are provided by the TILMedia 3.9

library, both from TLK-Thermo GmbH (Braunschweig, Germany). The effects of oil and of the oil management system were neglected. Even if the models could be dynamic, the results shown in the following section correspond to the steady state reached for each operating condition. Some of the main considerations in the model are listed below.

- Compressors (mass flow and power consumption) are modelled with manufacturer correlations for a larger compressor (10 cc) multiplied by a factor considering the ration of displacements.
- Gas cooler modelled as a refrigerant to air heat exchanger with air flow control aiming at 2 K temperature difference at the gas cooler outlet, e.g., 40 °C air temperature to 42 °C CO₂ temperature. Minimum gas cooler outlet temperature at 10 °C.
- HPV modelled as an orifice of controlled opening to adjust the high pressure according to the gas cooler outlet temperature, following a relation pressure-temperature similar to that presented in "Simple CO₂ one stage plan" (version 2.40) software (www.ipu.dk) and with low and high limits at 55 bar (compressor operating envelope) and 105 bar (limit discharge temperature), respectively.
- MT and LT cabinets were modelled as one evaporator per temperature level for simplicity, with a corresponding expansion valve regulating the refrigerant flow to maintain 8 K superheat at the outlet.
- Liquid receiver with perfect separation between liquid and vapour phases. Pressure regulated within 48 bar and 43 bar using the parallel compressor at ambient temperature of 30 °C or above, and the FGBV below this ambient temperature.

5. RESULTS

Figure 6 summarises the main findings in this study. First is the graph in the left, where the refrigeration loads (MT and LT) depending on the temperature bin (outdoors) are represented. Since the shop temperature should be kept under control as explained above to guarantee the temperature inside the cabinets, the loads do not vary as much as they would in an uncontrolled environment. Figure 6 left also represents the EER (energy efficiency ratio) of the different refrigeration systems, i.e., HFC-based MT, LT and AC refrigeration systems and R744 condensing unit, as a function of the temperature bin. The EER of the R744 centralized condensing unit, thus including LT and MT refrigeration, is particularly good at low ambient temperatures. The HFC-based refrigeration systems do not undergo such a high deterioration of their EER with ambient temperature since their condenser exchanges heat with the controlled atmosphere in the shop. On the other hand, it is necessary to have an air conditioning unit to transfer the heat out of the shop which otherwise would increase the temperature inside the shop and the refrigeration loads. The case studied in this article has an AC unit installed, as described in Table 1, which utilizes another HFC (R32). Due to the limited technical information about this unit, the EER as a function of the ambient temperature (condenser in this case is outdoors) was approximated based on the power consumption and cooling capacity at rated conditions, and assuming constant overall efficiency of the unit within the investigated conditions. This is definitely a source of uncertainty to the analysis but gives a good idea of the impact of the AC needed to remove the heat generated in the condensers of the display cabinets (HFC-based).

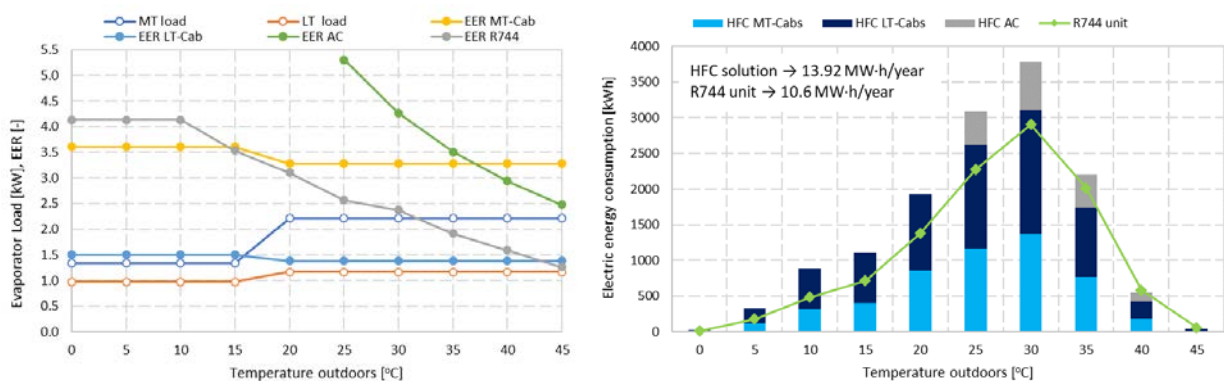

Figure 6. Left, total refrigeration loads (MT and LT) and EER of the different systems (HFC-based vs. R744 condensing unit) at different temperatures outdoors. Right, electric energy consumption per temperature bin (outdoors) and depending on the system (HFC-based vs. R744 condensing unit).

Figure 6 shows the electric energy consumption for each temperature bin with the different cases (R744 condensing unit vs. HFC-based individual cabinets). R744 condensing unit shows clearly lower energy consumption until 30 °C outdoors, and there is a turning point at 35 °C if considered only the energy consumption of the MT and LT display cabinets in the HFC-based case. However, a fair comparison requires to account for the AC term due to heat rejected by the condensers of the different display cabinets to the air in the shop, which is not the case for the R744 system. By doing so, the turning point is delayed to 40 °C, which has a relatively small repercussion in the yearly energy consumption. The yearly electric energy consumption calculated for the R744 centralized refrigeration system would be 3.3 MWh lower than with the existing solution based on HFCs (24% reduction). It should be noted that the base auxiliary consumptions of the different cabinets were neglected, since they would be comparable for both systems (HFC-based and R744). The electric consumption of the AC system non-related to the heat from the cabinets was also seen as comparable independently of the refrigeration architecture selected.

Recognizing that from an energy efficiency point of view, the R744 centralized condensing unit would outperform the existing solution (HFC-based), the discussion should follow with an economic evaluation of both options. Even if this is not the purpose of this article, a short discussion is covered here. It is conventionally stated that R744 systems and components are pricy compared to those for HFCs, due to economies of scale and technological readiness (to handle CO₂'s high pressures). However, it is evident from the literature that this gap is narrowing in the recent years. New materials such as K65 alloy allow relatively easy installation, compensating to a certain extent the additional piping (and insulation) needed from the R744 condensing unit to the different display cabinets. Even pure-copper piping of small diameters could be explored due to the small capacities of the case study, combined with the favourable properties of CO₂. Moreover, the suggested solution would comprise:

- only three relatively low-cost rotary R744 compressors compared to the nine compressors (one per display cabinet) required with the existing solution.
- a single gas cooler instead of individual condensers.
- equal number of evaporators, equipped with surely more costly expansion devices than the existing units.

6. CONCLUSION

Focus is to strategically develop a real-life solution to the distinct capacity supermarkets, a state-of-art R744 system and approach is evaluated to empower the small supermarkets to eliminate synthetic refrigerants and overcome the high ambient temperature performance constraint. The present study eventually accepts the vast potential of the R744 system in the tropical regions by targeting the energy and economic factors. In-fact, the outcome of the present study highlight's the potential of the eco-friendly R744 cooling technology for small supermarkets as an efficient strategy to replace the traditional synthetic HFC technologies. Furthermore, the application of R744 cooling technology path the way to avoid HFCs also in the AC unit by utilizing integration of AC in the R744 condensing unit, or utilization of environmentally friendly R290 in a dedicated AC device.

ACKNOWLEDGEMENT

The authors gratefully acknowledge the support received from the Research Council of Norway and user partners through HighEFF - Centre for an Energy Efficient and Competitive Industry for the Future, an 8-year Research Centre under the FME-scheme (Centre for Environment-friendly Energy Research, 257632/E20).

REFERENCES

- Ali, S. (2018). *The Future of Indian Electricity Demand* (Issue October).
<http://ebooks.cambridge.org/ref/id/CBO9780511996191>
- Gullo, P., Hafner, A., & Banasiak, K. (2018). Transcritical R744 refrigeration systems for supermarket applications: Current status and future perspectives. *International Journal of Refrigeration*, 93, 269–310.
<https://doi.org/10.1016/j.ijrefrig.2018.07.001>
- Singh, S., Hafner, A., Maiya, M. P., Banasiak, K., & Neksa, P. (2021). Multiejector CO₂ cooling system with evaporative gascooler for a supermarket application in tropical regions. *Applied Thermal Engineering*, 190(February), 116766. <https://doi.org/10.1016/j.applthermaleng.2021.116766>
- Singh, S., Maiya, P. M., Hafner, A., Banasiak, K., & Neksa, P. (2020). Energy efficient multiejector CO₂ cooling system for high ambient temperature. *Thermal Science and Engineering Progress*, 19(January), 100590. <https://doi.org/10.1016/j.tsep.2020.100590>

Yari, M., & Sirousazar, M. (2008). *Cycle improvements to ejector-expansion transcritical CO₂ two-stage refrigeration cycle*. November 2007, 677–687. <https://doi.org/10.1002/er>