



Economic evaluation of operation strategies for battery systems in football stadiums: A Norwegian case study[☆]

Kjersti Berg^{a,*}, Matthias Resch^{a,1}, Thaddäus Weniger^{a,2}, Stig Simonsen^b

^a Department of Energy Systems at SINTEF Energy Research in Trondheim, Norway

^b Department of Research & Development and Digitalization at Skagerak Nett AS, Porsgrunn, Norway

ARTICLE INFO

Keywords:

Battery energy storage system (BESS)
Degradation
Lithium-ion
Operation strategy
Techno-economic analysis

ABSTRACT

This paper describes a techno-economic evaluation of case studies performed at the Skagerak EnergyLab. The EnergyLab consists of a 1.1 MWh battery energy storage system (BESS) and a 800 kWp photovoltaic (PV) power plant installed in a football stadium. The aim of this paper is to analyse the installation's performance by studying a variety of cases involving operation strategies for peak shaving, self-consumption maximisation, energy arbitrage and feed-in limitation. The software tool SimSES is used to simulate BESS degradation. Moreover, the Norwegian economic and regulatory framework is used as a basis for an economic evaluation. An important outcome of this work is that a BESS that offers stacked value by combining peak shaving, energy arbitrage, self-consumption and the replacement of a backup diesel generator, may represent a feasible option in Norway. The techno-economic analysis also demonstrates that the profitability is heavily dependent on the operation strategy of the BESS.

1. Introduction

Battery energy storage systems (BESSs) are making their way into the distribution grid. Such systems can be beneficial for stakeholders at several levels by providing services for the grid or by acting as customers or a market participants. A BESS can typically provide services such as peak shaving, self-consumption maximisation of photovoltaic (PV) electricity, energy arbitrage, voltage regulation, frequency control and backup power.

This study analyses the potential of replacing mandatory diesel backup generators in football stadiums with a combined PV-BESS system. Although this is a niche application, it can easily be reproduced for other stadiums or even adapted to other infrastructures with backup systems. In addition to the replacement of backup diesel generators, we assess the feasibility and costs of (stacked) operation strategies for industrial applications in a Norwegian context.

Currently, the most profitable application of BESSs is in the provision of frequency containment reserve (FCR), as has been demonstrated in Germany [1] and Norway [2]. FCR is not within the scope of this study due to small market size, high market saturation and the legal problems of combining behind-the-meter and front-of-the-meter

applications [1]. It has also been previously analysed in a BESS-related Norwegian context in [2].

1.1. Batteries in Norway

Very few customers have installed BESSs in Norway, and a previous study [2] has shown that current battery prices make it economically unviable for a customer to purchase a BESS for peak shaving and for boosting self-consumption of PV-generated electricity. Most residential customers have an energy-based grid tariff and pay according to the amount of energy they use per month. Thus, they have no incentive to reduce their peaks. Industrial customers however, often have a capacity-based grid tariff and it is probable that such customers, operating with quite high load peaks compared to their "usual consumption", have more to gain from using a BESS for peak shaving.

1.2. Lithium-ion battery costs

In the last ten years, the costs of lithium-ion (Li-ion) batteries have decreased quite dramatically, and current costs are reported to be in the range of 400 to 1000 EUR/kWh [3,4]. However, a recent literature

[☆] This work was funded by the Research Council of Norway, the project consortium of the research project IntegER (269420), the Research Centre CINELDI (257626) and the research project ModFlex (255209).

* Corresponding author.

E-mail address: kjersti.berg@sintef.no (K. Berg).

¹ Now with the Department of Smart Grids at Fraunhofer ISE.

² Student at the TU Bergakademie Freiberg (TUBAF).

review of BESS costs in Germany [1] revealed that “(...) the market lacks transparency and that underlying assumptions about prices and battery dimensions often do not correspond to reality”. The authors reported that industry storage system prices currently are between 1000 EUR/kWh and 1500 EUR/kWh inclusive of VAT. Recent studies have shown that the cost of investing in a BESS based on Li-ion batteries in the period from 2020 to 2035 will continue to fall, at least within the next 5 years, although the size of the fall is highly uncertain, reported to be between 16% [5] and 33 % [4]. Due to this uncertainty, a conservative approach for the economic assessment is pursued, in which the price reduction of BESS is not taken into consideration. Moreover, potential electricity cost savings will depend heavily on the grid tariff the customer pays. Since BESS prices are highly uncertain, there is a need to study the profitability of industrial storage systems, and to find out the levels of investment that make such systems economically viable.

1.3. Techno-economic analysis of BESS

Several techno-economic and cost-benefit studies of PV and BESSs have been presented in the literature. Many of these focus on residential systems in which the BESS is used to increase self-consumption and/or perform peak shaving [6,7] and [8]. In [7], the authors demonstrate how different peak shaving strategies influence net present value (NPV). In [8], the authors found that battery ageing, in particular, impacted on the economic analysis, and that the battery had to be replaced one to three times over the 20-year analysis period. It is not our intention in this paper to investigate a residential BESS, but to look into aspects related to an industrial BESS application in a football stadium. Ref. [9], presented an investigation of the impact of battery degradation on energy arbitrage revenue related to grid-level energy storage. The authors found it important to integrate degradation into the analysis of battery profitability since this enabled a better assessment of the cost-effectiveness of energy storage investments. In this paper, we investigate operation strategies, including peak shaving and feed-in limitation, as well as energy arbitrage. A German case study [10] has shown that batteries used in peak shaving applications can shorten the payback period for large industrial loads, and that different variations in peak shaving strategies may have an impact on the economic result and battery ageing within the system.

1.4. Battery degradation

Battery models used in power system studies have often ignored degradation [11], which means that the operation strategy has not taken into account how BESS use affects ageing. The operation strategy greatly affects battery ageing and degradation because cyclic degradation depends on the state of charge (SOC), charging/discharging current, depth of discharge (DOD) and temperature [12]. As is stated in [13], research is needed to identify models that reflect cycle life characteristics of BESSs as a means of capturing the financial results linked to business cases, such as NPV analyses and improved optimisation approaches for stacked benefits.

A number of different degradation models have been presented in the literature: These include a non-linear Ni-Cd battery model that was used to evaluate BESS degradation for micro-grid operation [14]. This paper involved the determination of an optimal dispatch of the battery using a non-linear mixed-integer problem. Another approach, discussed in [15] involved calculating degradation costs using a capacity fade model.

The advantages of a more accurate non-linear battery degradation model, with linear optimisation for battery dispatch are presented in [16]. In this paper, a linear approach to an energy arbitrage scenario is presented involving variable electricity prices, and in which a marginal cost model is used in order to introduce less complex linear mixed-integer optimisation. By expanding on this approach, we consider and

analyse in detail the value of a stacked operation used to replace a backup generator in a football stadium. As part of a second step, we use the non-linear capacity fading of the battery model to calculate the replacement of the battery.

1.5. Value stacking

Value stacking, which involves the simultaneous performance of multiple services, often increases the BESS profitability, as discussed in [17]. However, it is likely that it also increases degradation due to the increased use of the BESS. It has also been shown that more detailed ageing models can result in more cost-aware battery dispatch strategies [18]. The authors highlight that multiple service use of a BESS often enhances profitability. An example of application stacking, performed by applying the same software tool as in this study is discussed in [19]. The main difference is that the reference describes German regulations and prices, and is not directly applicable to football stadiums with their specific load profiles and needs. Neither [18] nor [19] present an NPV analysis, but suggest that such work should be carried out in the future. In this paper, we close this gap by presenting a specific application within a Norwegian context, involving a BESS installed in a football stadium. We evaluate the profitability of the BESS for different multiple service cases and for different battery costs, as a basis for determining the BESS cost that results in optimal profitability.

1.6. Batteries installed in football stadiums

As noted previously, this paper studies the BESS installed at the Skagerak EnergyLab, which is situated in the Skagerak Arena football stadium. The EnergyLab consists of a BESS and PV system. Football stadiums differ from other industrial customers due to their distinct load profiles. Load peaks are high when the flood-lights are on, which only occurs during matches for a limited number of hours on a limited number of days per month. Such a scenario might thus be ideal for the use of a BESS to achieve peak shaving. We take this opportunity to note that the Amsterdam Arena has also installed a BESS. A previous study [20] has described how the BESS of the Amsterdam Arena could perform voltage control to relieve voltage issues in the grid (front-of-the-meter). However, the authors did not investigate a value stacking approach (behind-the-meter). This present study focuses on the behind-the-meter corporate benefit to a stadium owner. The authors see a great potential in this niche application, as there are currently 948 football stadiums in the EU, in which diesel backup generators could be replaced with a BESS.³

1.7. Contribution and structure

The aim of this study is to analyse the performance of the BESS currently installed in the Skagerak EnergyLab by investigating a number of operation strategy cases for peak shaving, self-consumption maximisation, energy arbitrage and feed-in limitation. The novel aspect of this approach is its focus on the profitability of a BESS in a football stadium that exhibits a high load due to flood-light operation. We shall also analyse how multiple service operation may influence the profitability of the BESS when degradation is taken into account. The work has been carried out as part of the research project ‘IntegER’ (Integration of energy storage in the distribution grid), which aims to generate new knowledge and practical guidelines that will enable energy storage systems to be integrated into the Norwegian distribution grid. The project partners are mainly distribution system operators (DSOs), and valuable knowledge and experience has been obtained by means of a number of battery pilot projects, of which the Skagerak EnergyLab is one.

³ See supplementary material for a list of football stadiums in Europe.

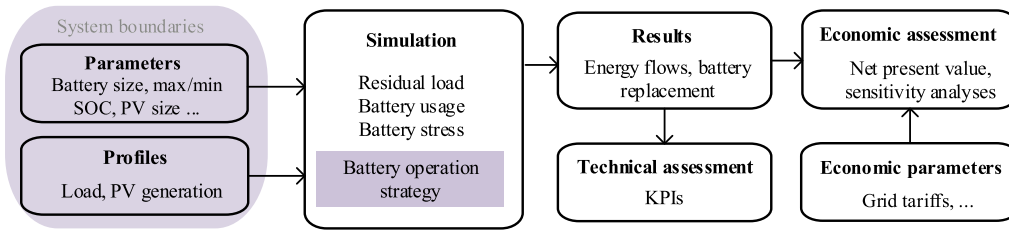

Fig. 1. Flowchart of method.

This paper is organised as follows: Section 2 describes the simulation methods and parameters, including system boundaries, technical and economic inputs, operation strategies, and the methods used for technical and economic evaluation. The case studies and input data from the EnergyLab are also introduced. Section 3 presents the results from the case studies. Section 4 compares the technical assessments, and Section 5 the economic assessments, of the case studies. Finally, Section 6 contains some concluding remarks and an outlook.

2. Method

The techno-economic analysis method is shown in Fig. 1. Parameters such as the size of the BESS and PV system are entered as input, together with load and PV generation profiles, which in turn depend on the system boundaries. The simulation is run for a ten-year analysis period, since this is the assumed lifetime of the BESS. The simulation results form the basis of the techno-economic evaluations, which include key performance indicators (KPIs) such as self-consumption ratio, self-dependency ratio and the calculation of NPV. The following subsections describe the individual steps.

2.1. System boundaries

This work comprises an analysis of the real-life BESS installed in the Skagerak EnergyLab pilot, which is owned by the DSO Skagerak Nett. However, the aim of the pilot project is to demonstrate its benefits to a variety of users, so in this study the BESS is assumed to be owned and operated by the stadium for the main purpose of covering the flood-light load and minimising electricity costs. It is therefore also assumed that the BESS is operated from behind-the-meter of the stadium, following the definition of behind-the-meter as in [19]. Fig. 2 shows a simplified overview of the grid set-up at Skagerak EnergyLab, with node P1 indicating the main connection point to the external power grid. This node is also connected to the BESS, PV plant and flood-lights, as well as to other loads such as apartments and offices.

2.2. Parameters and profiles

The aggregated load profile for node P1 is shown in Fig. 3. During a football match, the BESS should be equipped to cover the flood-light load (which is a part of the load at node P1). The load data indicates when a match is taking place. Peaks that are significantly higher than the remaining load are assumed to represent the flood-lights use during football matches. The flood-light power is 320 kW.

Since no production data from the installed PV system were available for 2018, irradiation data were used to create a PV generation profile. The profile is the same as that described in [21], where (1) was used to calculate the power (in kW) generated by the PV system.

$$P_{PV} = c_F \cdot \eta_{PV} \cdot \eta_{bos} \cdot S_{PV} \cdot p_{rad} \quad (1)$$

where c_F is a correction factor, assumed to be 0.95, η_{PV} is the conversion efficiency of the PV modules, assumed to be 0.158, η_{bos} is the system efficiency, assumed to be 0.91, S_{PV} is the PV surface, set to 5330 m², and p_{rad} is the global horizontal irradiance in kW/m²,

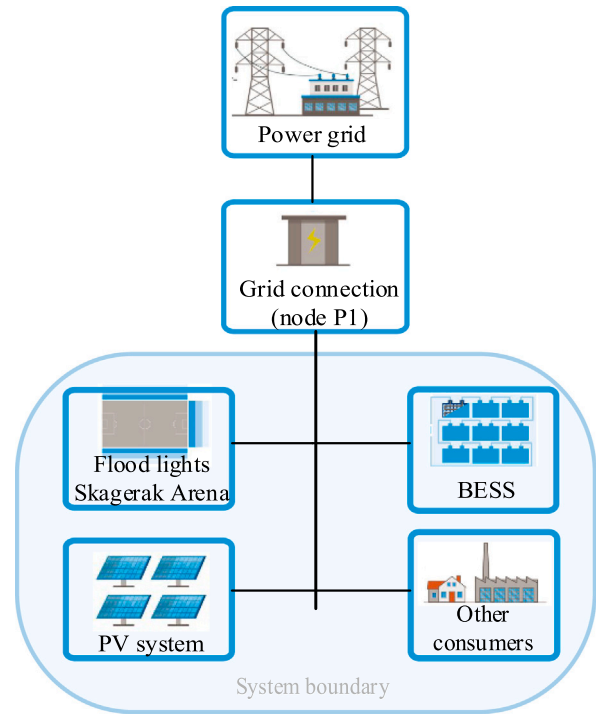

Fig. 2. Overview of electricity flow at the Skagerak EnergyLab.

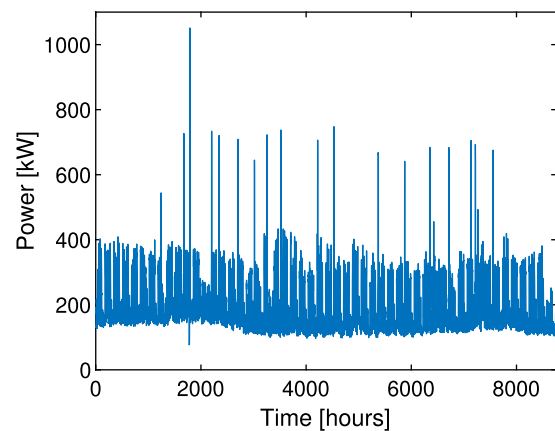

Fig. 3. Load profile for node P1, based on measured hourly data from 2018.

retrieved for the year 2016 from a weather station located 2 km from the stadium [21]. The resulting PV profile is shown in Fig. 4.

The input load and generation profiles are from a single year (2018), and are then used for each of the ten years of the analysis period. The load is assumed to be constant throughout the analysis period, while the PV system is assumed to age by a factor of 0.5% per year. Table 1 shows

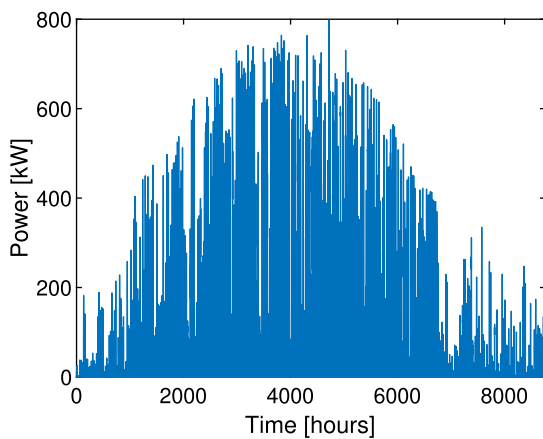

Fig. 4. PV generation profile used in the simulations, based on hourly irradiation data from 2018.

Table 1

Technical parameters for BESS, PV and load.

Component	Property	Value
BESS	Nominal energy capacity	1100 kWh
	Nominal power capacity	800 kW
	Type	Li-ion
	Nominal voltage	400 V
	Maximum SOC	95%
	Minimum SOC	5%
	Standby power consumption	0 kW
	End of life SOH	80%
	Inverter efficiency	Power/eta characteristic
PV	Nominal power	800 kW
	Profile type	Calculated hourly data
	PV ageing per year	0.5%
Load	Total consumption (FL)	15.9 MWh
	Total consumption (P1)	1752 MWh
	Profile type	Measured hourly data (2018)

the specification parameters of the BESS, PV and load at the Skagerak EnergyLab. The BESS was sized in accordance with the criterion that its energy capacity must cover the flood-light load during a football match (1.1 MWh), and that its power capacity should be equal to the PV generation (800 kWp). The simulation is carried out in hourly steps, since this is also the given resolution of the generation and load profiles.

2.3. Economic parameters

The economic evaluation is based on the results from the simulation, combined with input economic parameters. In Norway, an industrial customer pays a grid connection cost, a capacity-based grid tariff cost, a spot market cost and a fixed annual fee. A consumer that also produces energy at certain hours during the year is called a prosumer. Prosumers receive a feed-in remuneration per kWh that is equal to the spot price. However, if the feed-in is greater than 100 kW, the prosumer must pay a fee of 0.0134 NOK/kWh [22].⁴ Table 2 shows the grid tariffs for a DSO operating in Norway.

2.4. Simulation - degradation model

The use of the BESS, including ageing characteristics that depend on battery type, is simulated in SimSES using an existing model of a nickel cobalt aluminium oxide (NCA) battery [24]. This NCA technology is commonly used in grid storage projects [25].

Table 2

Grid tariff for industrial customer [23].

Season	Fixed grid tariff (NOK/year)	Consumption-based grid tariff (NOK/kWh)	Capacity-based grid tariff (NOK/kW per month)
Summer (1/4-30/9)	22,000	0.036	51.00
Winter (1/10-31/3)	22,000	0.042	57.00

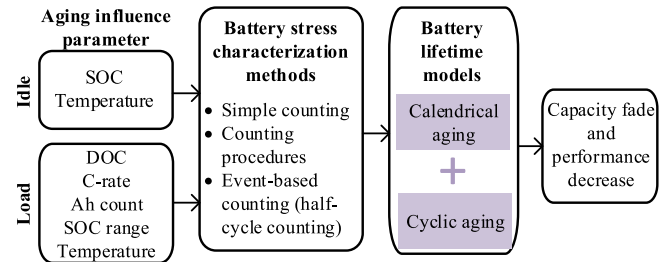

Fig. 5. The SimSES battery degradation model [31].

Several software tools have been developed with the aim of studying energy flows in a system containing a BESS (with and without degradation). These include PerModAC [26], StorageVET [27], Blast [28], SimSES, HOMER [29] and SAM [30]. In this study, the open-source tool SimSES⁵ was used because it offers a holistic approach, combined with a degradation model for Li-ion batteries.

The degradation model in SimSES has been introduced in [31] and explained extensively and verified in [32]. The battery model is implemented in the form of a single-cell electric circuit model based on measurement data and a full cell characterisation. Implementation of the degradation model in SimSES is shown in Fig. 5.

This tool has been used previously for several applications [33,34], although not in a Nordic country. Since the code is open-source, additional operation strategies and economic evaluations have been added, and the code adapted to the Norwegian context. More information regarding SimSES can be found in [31] and [32].

2.5. Simulation - operation strategies

BESS usage is determined using a number of different operation strategies: self-consumption maximisation, the prioritisation of flood-lighting for football matches, energy arbitrage, peak shaving and feed-in limitation. For the maximisation of self-consumption, an existing strategy available in the SimSES tool was used, while the remaining strategies were developed specifically for this study. The strategies are based on a perfect forecast, which assume that the load and PV generation are known. This assumption is not far from reality in terms of the flood-light load because football matches are scheduled in advance. In contrast, other loads derived from offices, shops and apartment buildings are more difficult to predict.

Five case studies were carried out in order to see how the various operation strategies affected the techno-economic analysis. Brief descriptions of these cases are given in Table 3, and each case is described in more detail in the following. As previously mentioned, the simulation is carried out in hourly steps.

2.5.1. Case 1: Self-consumption maximisation, covering only flood-lighting load

In Case 1, only the flood-lighting load is considered, with the operation strategy solely targeted at maximising self-consumption. This strategy already existed in the SimSES software, where it is called

⁴ 1 NOK equals approx. 0.09 EUR.

⁵ <https://gitlab.lrz.de/open-ees-ses/simses>.

Table 3

Case descriptions.

Case no.	Case name	Description
1	SC_FL	Self-consumption maximisation. Only flood-light (FL) load was used in the simulation.
2	SC	Self-consumption maximisation.
3	SC_FLprio	Self-consumption maximisation with prioritisation of flood-lighting.
4	OPT	Optimised usage in order to minimise costs, including energy arbitrage. Reserved for flood-lighting on match days.
5	OPT_aPS	Optimised usage in order to minimise costs, including peak shaving, self-consumption maximisation, feed-in limitations and energy arbitrage.

OSPVHomegreedy. The strategy is rule-based and follows the sequence given in Algorithm 1.

Algorithm 1 Self-consumption maximisation

SOC_{bat} , Battery SOC in %
 P_L , Load of node P1 in kW
 P_{PV} , PV generation in kW
 $P_{res} \leftarrow P_L - P_{PV}$

for $t=1:8760$ **do**
 if $P_{res} < 0$ **and** $SOC_{bat} < 95$ **then**
 $P_{Bc} = -P_{res}$
 else if $P_{res} < 0$ **and** $SOC_{bat} = 95$ **then**
 $P_{Gp} = -P_{res}$
 else if $P_{res} > 0$ **and** $SOC_{bat} > 0$ **then**
 $P_{Bd} = P_{res}$
 else if $P_{res} > 0$ **and** $SOC_{bat} = 95$ **then**
 $P_{Gp} = P_{res}$
 end if
end for

2.5.2. Case 2: Self-consumption maximisation

This case is similar to Case 1, except that it considers the entire node P1 load.

2.5.3. Case 3: Self-consumption maximisation while also prioritising flood-lighting

Case 3 is similar to Case 2, except that flood-lighting is prioritised. This means that the BESS is reserved for days on which matches are scheduled in order to ensure that it can cover the flood-lighting load. This strategy is rule-based and follows the sequence given in Algorithm 1, as well as that in Algorithm 2.

2.5.4. Case 4: Energy arbitrage

Case 4 utilises an optimisation strategy to perform energy arbitrage, thus taking advantage of daily energy price fluctuations. A daily operating schedule is obtained from a model predictive control (MPC). It uses an optimisation algorithm, which has a rolling horizon looking an additional day ahead of the scheduled one. This optimisation approach is based on that described in [35]. This strategy considers only costs and revenues associated with energy purchase/feed-in, thus ignoring the peak load grid tariff, which is considered in the next strategy. The optimisation is described in the following.

The objective function, involving cost minimisation, is shown in (2). The costs in question here are the energy costs $C_{Gp,t}$, the energy revenues $C_{Gf,t}$ and the cost of storage degradation $C_{StoDeg,t}$.

$$\min C_{tot} = \sum_{t=1}^n C_{Gp,t} - C_{Gf,t} + C_{StoDeg,t} \quad (2)$$

where t is the timestep, and n the number of timesteps.

Algorithm 2 Prioritising flood-lighting

SOC_{bat} , Battery SOC in %
 P_L , Load of node P1 in kW
 P_{PV} , PV generation in kW
 M_{-1} , Set of hours one day ahead of a match
 M , Set of hours on match day, before match
 N , Set of hours on match day, during match
 $P_{res} \leftarrow P_L - P_{PV}$

for $t=1:8760$ **do**
 if $t \in M_{-1}$ **then**
 $P_{Bd} = 0$
 else if $t \in M$ **and** $SOC_{bat} < 95$ **then**
 $P_{Gp} = \max(P_{res}, 320)$
 else if $t \in N$ **and** $P_{PV} < 320$ **then**
 $P_{Bd} = 320 - P_{PV}$
 end if
end for

Energy purchase costs are calculated from (3):

$$C_{Gp,t} = \sum_{i=1}^n E_{p,i,t} \cdot (c_{E,t} + c_{Gu,p}) \quad (3)$$

where $E_{p,t}$ is purchased energy, $c_{E,t}$ is the spot market price and $c_{Gu,p}$ is the grid usage price for the load, also called the consumption-based grid tariff, for timestep t .

Feed-in remuneration is calculated from (4):

$$C_{Gf,t} = \sum_{i=1}^n E_{f,i,t} \cdot c_{E,t} \quad (4)$$

where $E_{f,t}$ is the amount of feed-in energy during timestep t .

Storage degradation costs are approximated from (5):

$$C_{StoDeg} = \sum_{i=1}^n E_{Bc,i,t} \cdot c_{StoDeg} \quad (5)$$

where c_{StoDeg} is the specific degradation cost of the BESS in NOK/kWh and $E_{Bc,t}$ is the energy charged into the battery during timestep t .

Storage costs are predicted in the optimisation using a linear model, as opposed to the non-linear ageing model that is used to simulate battery degradation resulting from its operation. The marginal costs of energy arbitrage operations are described in [16] and comprise storage degradation costs and the costs resulting from energy losses. In the optimisation, the latter are already included in the energy system simulation that incorporates efficiencies for BESS charging and discharging, and for the inverter. The figure given in [16] is used as an estimate of degradation costs, amounting to 1.28 EURct/kWh, which is equal to 0.128 NOK/kWh at an exchange rate of 10 NOK/EUR (as of 12 August 2019). This factor is calculated based on the model described in [36], and includes two different cycle ageing mechanisms, the first being current-independent ageing that is driven by power throughput and which occurs while charging and discharging, and the second being current-dependent cycle ageing that occurs during charging. Calendar ageing effects are not considered because only additional costs resulting from operation are included in the calculations.

Constraints to the optimisation are given by (6) and (7):

$$P_{Gp,t} + P_{Gf,t} + P_{Bc,t} + P_{Bd,t} = P_{res,t}, \forall t \quad (6)$$

where $P_{Gp,t}$ is the electricity purchased from the grid, $P_{Gf,t}$ is the feed-in power, $P_{Bc,t}$ is the battery charging power, $P_{Bd,t}$ is the battery discharging power and $P_{res,t}$ is the residual load after subtracting PV generation, for timestep t .

$$P_{Bc,t} \cdot \eta_{Bc} + \frac{P_{Bd,t}}{\eta_{Bd}} = -\frac{E_{bat,t} - E_{bat,t-1}}{\Delta t} \quad (7)$$

$E_{bat,t}$ is the energy in the battery during timestep t , η_{Bc} is the efficiency when charging and η_{Bd} is the efficiency when discharging.

2.5.5. Case 5: Peak shaving, energy arbitrage and feed-in limitation

As in Case 4, Case 5 also uses optimisation, but here the peak-load and feed-in costs are included in the objective function. This strategy thus contributes to value stacking. The objective function is shown in (8) and, as in Case 4, also minimises the costs:

$$\min C_{tot} = \sum_{t=1}^n C_{Gp,t} - C_{Gf,t} + C_{StoDeg,t} + C_{PT,t} + C_{Gu,f,t} \quad (8)$$

where $C_{PT,t}$ is capacity-based grid tariff costs and $C_{Gu,f,t}$ is costs for feed-in above 100 kW, in timestep t .

The costs of purchased energy and storage degradation, as well as the feed-in energy revenues, are calculated in the same way as previously described for arbitrage. The capacity-based grid tariff costs, $C_{PT,t}$, are charged monthly and depend on the peak load power. To decide on the peak load value for any given month, an initial limit is set for the first day, and is then adjusted if necessary on a daily basis. The algorithm is described in Algorithm 3, and is only applied on days when no matches are played.

Algorithm 3 Determine peak shave limit in Case 5

P_L , Load of node P1 in kW
 P_{PV} , PV generation in kW
 $P_{G,m}$, Peak shave limit of the month
 $P_{overlim}$, Power above $P_{G,m}$ (costs increased)
 ΔP , Step size for limit increment (10 kW)
 m , Current month of simulation
 d , Current day of simulation
 $P_{res} \leftarrow P_L - P_{PV}$

```

for  $m=1:12$  do
   $P_{G,m} = 0.75 \cdot \max(P_{res,m})$ 
end for
for  $d=1:365$  do
   $exit \leftarrow 0$ 
  while  $exit == 0$  do
    Run optimisation for Case 5
    if  $P_{overlim} = 0$  then
       $exit \leftarrow 1$ 
    else
       $P_{G,m} \leftarrow P_{G,m} + \Delta P$ 
    end if
  end while
end for

```

The capacity-based grid tariff cost is calculated as in (9):

$$C_{PT} = P_{G,month} \cdot c_{pt} = (P_{initial} + P_{overlim}) \cdot c_{pt} \quad (9)$$

where $P_{G,month}$ is the highest peak shave limit of the month in question, $P_{initial}$ is the initial peak shave limit from the first day of that month, $P_{overlim}$ is the increase in peak shave limit in kW and c_{pt} is the capacity-based grid tariff cost in NOK/kW.

The grid usage cost is calculated as:

$$C_{Gu,f} = E_{Gf>100} \cdot c_{Gu} \quad (10)$$

where $E_{Gf>100}$ is the energy in excess of the feed-in limitation (100 kW) and c_{Gu} is the grid usage price for feed-in in excess of 100 kW (assuming a fixed grid tariff of 0.0134 NOK/kWh [22]).

2.6. Economic evaluation

The economic evaluation is performed using an NPV calculation. Four different costs and revenues are considered, as shown in (11),

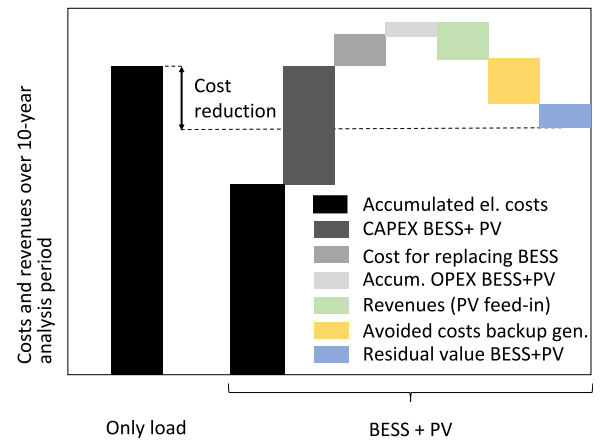

Fig. 6. Illustration showing how the economic evaluation is performed, involving costs and revenues over the 10-year analysis period.

which is taken from [37] and adapted to this specific Norwegian PV-BESS case study. The costs saved by not using a backup generator during football matches is included, because the generator is replaced by the BESS.

$$NPV = \text{Inv. costs} + \text{Cashflow diff.} + \text{Disc. costs} + \text{Residual values} \quad (11)$$

The investment costs are calculated as:

$$\text{Inv. costs} = -(S_{BESS} Pr_{BESS} + S_{PV} Pr_{PV}) \quad (12)$$

where S_{BESS} and S_{PV} are the BESS capacity in kWh and the PV system size in kWp, respectively. Pr_{BESS} and Pr_{PV} are the BESS price in NOK/kWh and the PV system price in NOK/kWp, respectively. It is assumed that the BESS costs include the costs for the inverter.

The cashflow difference is calculated as:

$$\text{Cashflow diff.} = \sum_{t=1}^n \frac{|CF_{woBESS+PV}| - |CF_{BESS+PV}|}{(1+i)^t} \quad (13)$$

where $|CF_{woBESS+PV}|$ and $|CF_{BESS+PV}|$ are the cashflows without and with BESS and PV, respectively. In the case where BESS and PV are not used, all electricity is purchased from the grid. These are discounted over the analysis period, where i is the interest rate, t is the timestep and n is the analysis period of ten years. Other discounted costs are calculated as:

$$\text{Disc. costs} = \sum_{t=1}^n \frac{-C_{repl} - C_{O\&M} + C_{gen}}{(1+i)^t} \quad (14)$$

where C_{repl} is the replacement cost of the BESS, assuming that it is replaced during the analysis period. $C_{O\&M}$ is the cost for operation and maintenance (O&M) of the BESS and PV. C_{gen} is the cost that is avoided by not having a backup generator. The costs for a future replacement of the BESS are assumed to be same as in the first year, to keep consistent with the conservative approach of the economic assessment, which is also reflected in the conservative BESS degradation calculation. All of these factors are discounted over the analysis period with the residual values being calculated as in (15).

$$\text{Residual values} = \sum_{t=1}^n \frac{R_{n,PV} + R_{n,BESS}}{(1+i)^t} \quad (15)$$

where $R_{n,PV}$ is the residual value of the PV system and $R_{n,BESS}$ is the residual value of the BESS following the analysis period.

Fig. 6 provides an illustration of how the economic evaluation is performed, and Table 4 shows the parameters used as input.

Table 4
Economic evaluation parameters.

Parameter	Assumed value
Interest rate	5%
Inflation rate	3%
Real interest rate	1.94%
Analysis period	10 years (assumed lifetime for BESS).
SOH where BESS is replaced	80%
Residual value of BESS	Calculated according to the SOH at the end of the analysis period, e.g. a SOH of 95% gives 75% of residual value.
Saved generator costs	10,000 NOK/football match. This assumes 18 matches a year (based on data from 2018). These costs include those incurred by having the backup generator operational in reserve (CAPEX, OPEX and other costs).
Capital expenditures (CAPEX)/investment costs of a PV system	1000 NOK/kWp
Lifetime of PV system	20 years
Residual value of PV system	50% of CAPEX after 10 years
CAPEX/investment costs of a BESS	Output of the economic analysis (varies)
Operation and maintenance expenditures (OPEX)	1% of CAPEX of the PV system, and 1% of (the varying) CAPEX of the BESS

2.7. Technical evaluation

The different cases were compared and evaluated by examining annual energy flow, the SOC of the BESS and the subsequent state of health (SOH) over the analysis period. The following relative key performance indicators were also studied:

- PV self-consumption rate (SCR): the amount of energy produced by the PV system and used to cover the load.
- Self-dependency rate (SDR): the relative amount of consumed power provided either directly by the PV system, or provided by the PV system via storage in the BESS.
- Relative battery usage (RBU): the number of hours during which the BESS was used to cover a load, divided by the number of hours (8760) in a year.

3. Results

As mentioned previously, load profile and PV generation values were given for a single year, and it has thus been assumed that the load and generation are equal over the ten-year analysis period. The SimSES simulations and economic evaluations for the five cases were thus carried out for a ten-year period. In order to obtain a simplified picture of how the different operation strategies affect the profiles, the results for each case are presented for a single reference week. The week chosen was from Tuesday 22 May to Monday 28 May 2018 (Fig. 7). The figure shows PV generation and the load profile for node P1 during this period, and also includes the residual load profile, which is the load or generation as seen from the connection point to the grid. The reference week exhibits days with high electricity consumption and low generation, as well as days with high generation and low consumption. A football match took place on Sunday 27. May as indicated by the distinct load peak for the Sunday evening.

3.1. Case 1: Self-consumption maximisation, covering only flood-lighting load

This case simulates the use of the BESS to cover no loads other than flood-lighting (FL). Since flood-lights are used only 18 times during the

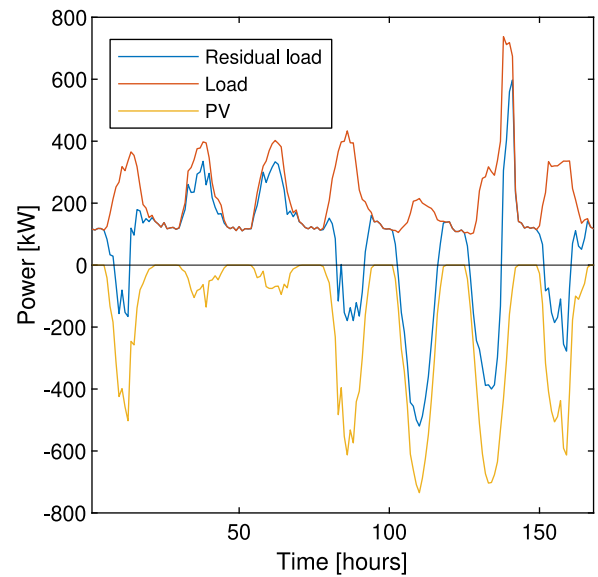

Fig. 7. Load, generation (PV) and residual load profile (load and PV) during the reference week (21–27 May).

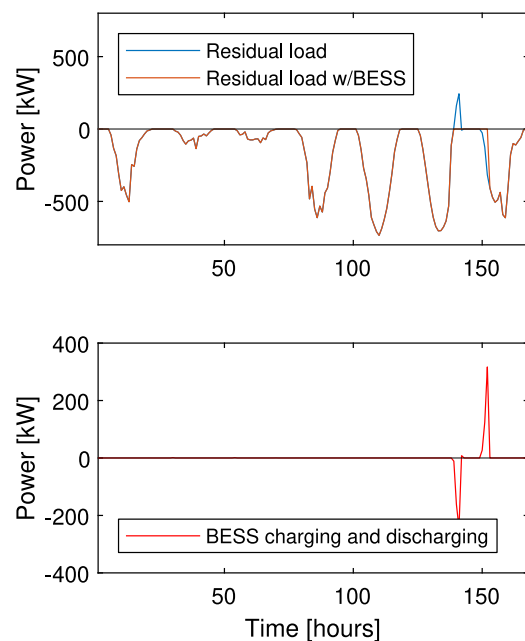

Fig. 8. Case 1: Residual load profile with and without the BESS, with the BESS charging and discharging during the reference week (21–27 May). The BESS is presented from a generator perspective (i.e. charging negative values and discharging positive values).

year (based on data from 2018), no economic benefit of this usage is expected. It is thus considered as a reference scenario.

Constant electricity consumption of 320 kW is assumed during flood-light use. The operation strategy selected is the maximisation of self-consumption, meaning that the load is covered primarily by PV production, and only secondarily by the BESS. Electricity is only taken from the grid if the battery is empty. The battery is charged as rapidly as possible using power provided by the PV system. The results of Case 1 for the reference week are shown in Fig. 8. The only load registered is during the match, and is covered mostly by PV generation and in part by the battery. As the figure shows, the BESS is hardly utilised at all.

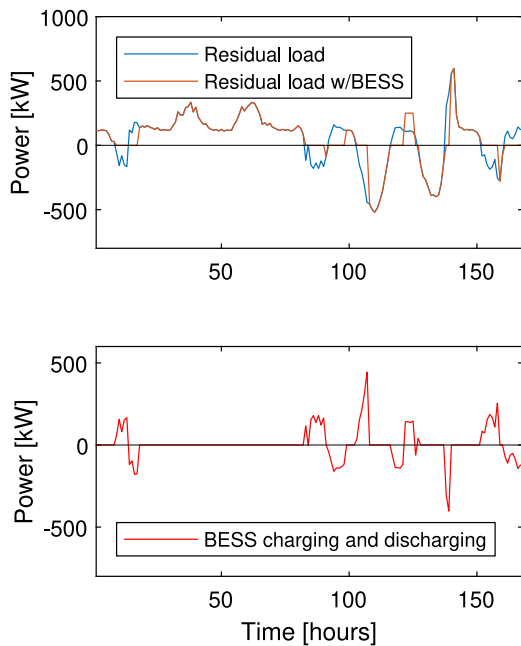

Fig. 9. Case 2: Residual load profile with and without the BESS, and with the BESS charging and discharging during reference week (21–27 May). The BESS is presented from a generator perspective.

3.2. Case 2: Self-consumption maximisation

In Case 2, for which the operation strategy remains self-consumption maximisation, the BESS is used to cover the load at node P1. Intuitively, this increase in load should lead to higher BESS usage and thus greater profitability from the battery, compared to Case 1. There is an in-built constraint on match days, however, because the BESS is charged the night before match days in order to ensure that it is fully prepared when the match begins. The dates when matches take place are included in the operation strategy, ensuring that the BESS can be operated differently on these days. Results for the reference week are shown in Fig. 9 and clearly show that the BESS is used more, but not every day. During the match, the load is covered by both PV generation and the BESS. However, the BESS becomes fully discharged during the match, resulting in a grid load demand that is quite close to peak power. This is the reason for introducing a constraint on match days in Case 3.

3.3. Case 3: Self-consumption maximisation with flood-lighting prioritised

The aim in Case 3 is to use the BESS for self-consumption maximisation, while at the same time prioritising flood-lighting in order to make sure that the BESS is able to cover the load peak required during matches. In order to ensure that the battery is not empty on match days, a new operation strategy must be adopted. This involves not discharging the battery on the day before a match, and reserving the BESS to cover flood-lighting only on the match day itself. After match day, the BESS is returned to self-consumption maximisation mode. The results of Case 3 for the reference week are shown in Fig. 10, where the SOC plot shows that all the energy in the BESS has been consumed by the end of the match.

3.4. Case 4: Energy arbitrage (optimisation)

In Case 4, self-consumption maximisation strategy is abandoned. Optimisation is performed for the purposes of energy arbitrage (to minimise energy costs), assuming perfect forecast of spot market fluctuations, as described in Section 2.5.4. As in Case 3, the BESS is reserved

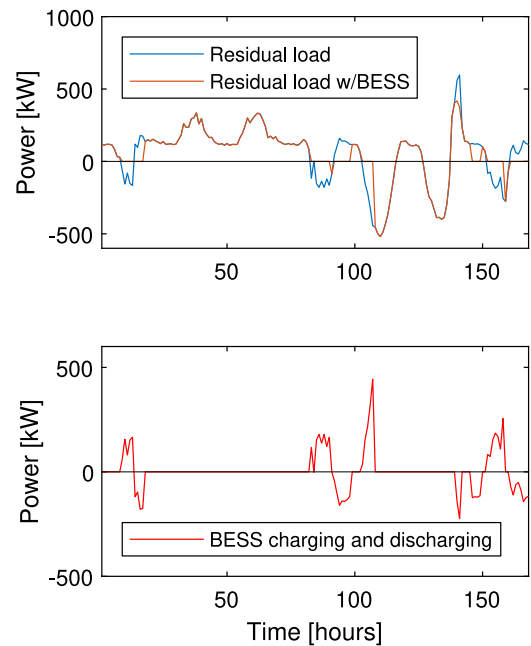

Fig. 10. Case 3: Residual load profile with and without BESS, and with the BESS charging and discharging during reference week (21–27 May). The BESS is presented from a generator perspective.

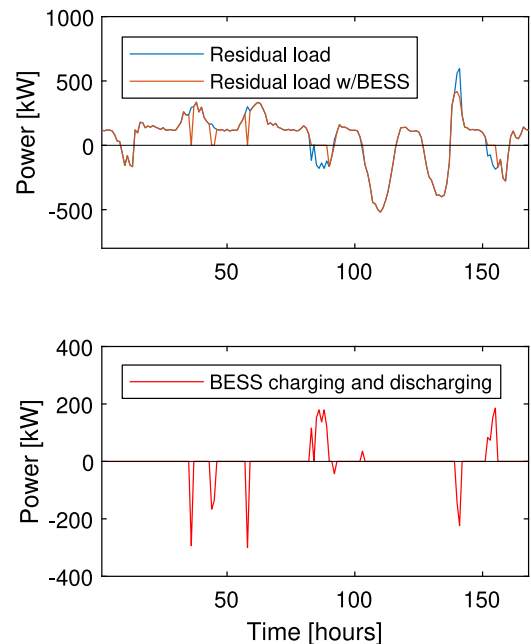

Fig. 11. Case 4: Residual load profile with and without BESS, and with the BESS charging and discharging during reference week (21–27 May). The BESS is presented from a generator perspective.

for flood-lighting on match days only. The capacity-based grid tariff is not taken into account in the optimisation in this case. The result for the reference week are shown in Fig. 11. Since the operation strategy is contingent on the electricity spot price, the price fluctuation in Norway for the week 21–27 May 2018 is shown in Fig. 12. The results show that energy stored in the battery was used primarily during periods when the electricity price was high, with feed-in is being avoided when the prices were low.

In order to illustrate how 2018 spot prices compare with other years, box plots of the years 2015–2019 are shown in Fig. 13. 2018

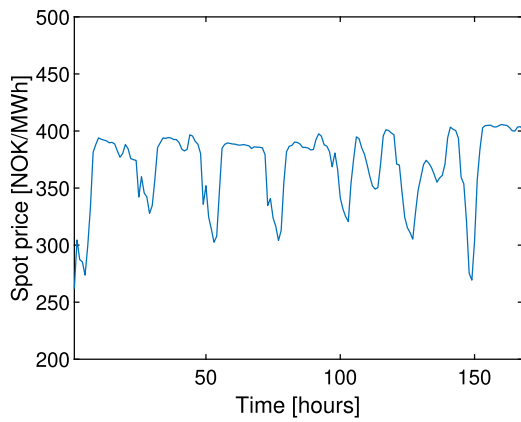

Fig. 12. Electricity spot price for the reference week (21–27 May 2018).

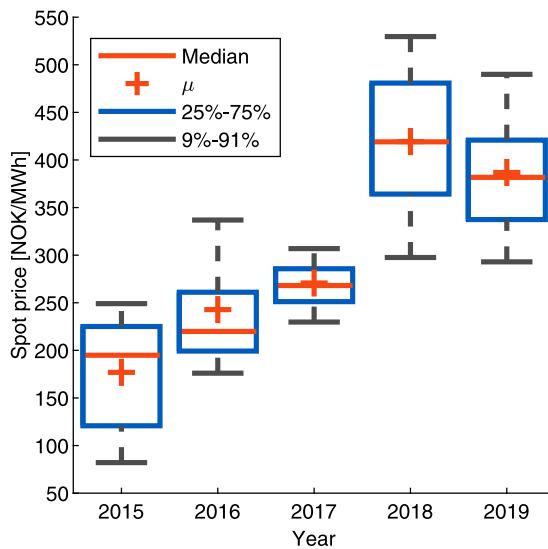

Fig. 13. Box plot of electricity spot prices in Norway (2015–2019).

exhibited a median spot price of 419 NOK/MWh, which is the highest of all the five years considered. When comparing 2018 to the average of all five years, it is found that the 2018 median spot price is 20% higher than the average median spot price. Further, the figure shows that 2018 has a high interquartile range (the difference between the upper and lower quartile). The interquartile range is 135% higher than for the average of all the five years. The difference between the 91st percentile and the 9th percentile for 2018 was 121 NOK/MWh.

Since electricity costs involve additional components, such as the capacity-based grid tariff and the power-dependent grid usage price, these are included in the Case 5 optimisation.

3.5. Case 5: Energy arbitrage, peak shaving, feed-in limitation (optimisation)

Case 5 is based initially on Case 4, but the capacity-based grid tariff and grid usage costs are now included as optimisation constraints, and the BESS is not explicitly reserved for flood-lighting on match days. This means that the optimisation will decide when to charge the BESS and the peak shaving limit.

As noted in Section 2.5.5, this case is somewhat similar to Case 4, but the objective now is to minimise all energy costs, including the capacity-based grid tariff.

The results for the reference week are shown in Fig. 14. On the match day, the BESS peak shaves such that electricity taken from

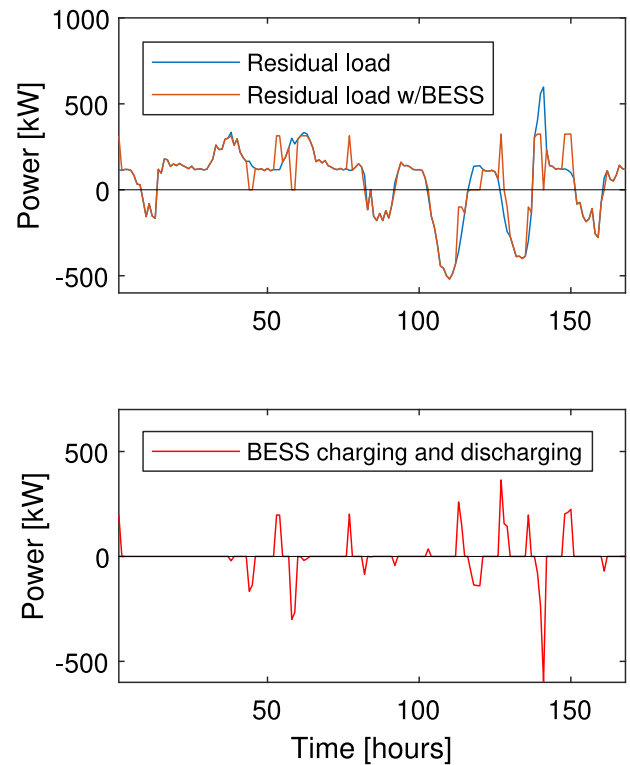

Fig. 14. Case 5: Residual load profile with and without BESS, and with the BESS charging and discharging during reference week (21–27 May). The BESS is presented from a generator perspective.

the grid is lower than in Case 4, meaning that the BESS is covering more than just the flood-lighting load. It is also clear that the BESS is charging and discharging during periods when this is economically most beneficial (arbitrage). We note also that feed-in from the PV system exceeds the 100 kW limit on several days, meaning that the costs incurred for feed-in over 100 kW are not high enough to affect the use of the BESS.

3.6. Comparison of all cases

The technical results for the five cases are summarised in Table 5 for the ten-year analysis period.

4. Technical assessment

Based on the analysis of the various cases described in the preceding sections, we will now compare factors such as degradation of the BESS, energy flows within the system and some relative key-performance indicators (KPIs).

4.1. Degradation of the BESS

The SOH of the BESS over the 10-year analysis period is shown in Fig. 15, and clearly illustrates how the different operation strategies have affected degradation of the battery. In Case 1, degradation is approximately linear because the load is quite low (flood-lighting only). Degradation here is due mainly to calendar ageing, as opposed to cycle ageing. The SOH value is 0.86 at the end of the analysis period. In Cases 2, 3 and 5, degradation is affected more by cycle ageing, resulting in SOH values of 80% after 8.3, 8.5 and 8.7 years, respectively. The BESS is then replaced, as is illustrated by a return to an SOH value of 100%. In Case 4, the SOH value is 0.826 after ten years, showing that it was not replaced during the analysis period.

Table 5
Technical results for Cases 1–5 for the ten-year analysis period.

Ten-year simulation parameters	Case				
	1	2	3	4	5
Total load (GWh)	61	6307	6307	6307	6307
Total generation (GWh)	2989	2989	2989	2989	2989
Total feed-in (GWh)	2924	457	463	740	939
Total purchased energy (GWh)	7	3877	3875	4097	4377
BESS: Energy in (GWh)	51	550	507	203	437
BESS: Energy out (GWh)	40	448	413	164	358
BESS: Energy losses (GWh)	11	102	94	39	80
Relative losses (losses/feed-in)	0.213	0.186	0.186	0.190	0.182
BESS usage (hours with discharge/total hours)	0.005	0.126	0.116	0.040	0.079
Number of battery replacements	0	1	1	0	1
BESS: SOH end	0.857	0.960	0.968	0.826	0.972
Self-consumption ratio	0.022	0.847	0.845	0.752	0.686
Self-dependency ratio	0.890	0.385	0.386	0.350	0.312
Maximum power drawn from grid (kWh/h)	320	733.6	731.6	766.7	726.8
BESS: Full equivalent cycles (-)	111	1258	1160	461	1002

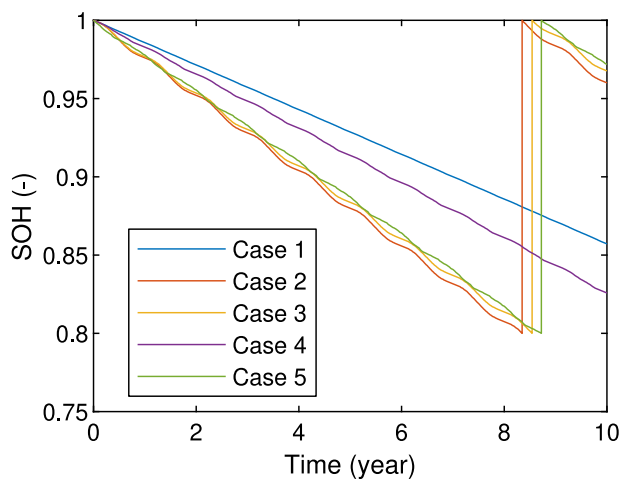

Fig. 15. State of health (SOH) of the BESS for the five cases over the ten-year analysis period.

The degradation of the BESS for all cases is almost linear, in contrast to what is reported in the literature [15,38,39]. Nonetheless, an almost linear behaviour is also shown in [40], in which an NMC cell model was applied. But the non-linear behaviour can still be seen at the beginning of the degradation. In this study, however, the default NCA model of SimSES was used, based on the degradation characteristic of [24]. It seems that it does not show the same non-linear degradation at the high SOH states, as other battery types, e.g. shown in [15,38,39].

In the cases we analysed, the capacity fade in relation with the full equivalent cycles are shown in Fig. 16 and Table 5. In SimSES, the capacity degradation is calculated as a superposition of the calendar and cyclic ageing. A quasi-linear ageing behaviour is reported especially for calendar ageing of NCA Li batteries [41] and a non-linear ageing for cyclic ageing [38]. In the five analysed cases the amount of equivalent cycles are between 111 cycles in Case 1 and 1258 cycles in Case 2. This means that in all cases, but especially in case 1, the calendar ageing outweighs the cyclic ageing by far. This effect can be seen clearly in Case 1, which shows an almost linear degradation and very few full equivalent cycles in the ten-year lifespan of the BESS. Thus, the curve is very steep. In Case 2, in which the BESS cycles by the factor of 10 more than in Case 1, the curve is less steep. Furthermore, it can be seen that it is not as linear as for Case 1, due to the cyclic ageing which is reported as being non-linear. It can be deduced from Fig. 16 that the calendar ageing of the Rosenkranz NCA BESS model [24] implemented in SimSES has a very high rate of degradation. This may be attributed to the old battery type, compared to more modern cell chemistries and

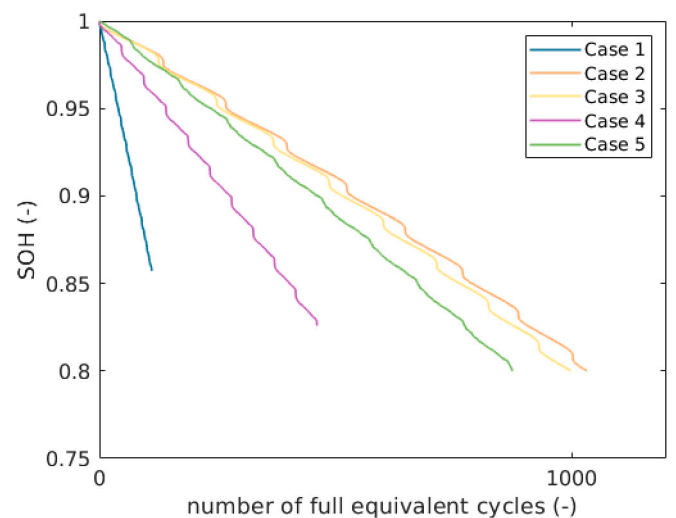

Fig. 16. State of health (SOH) of the BESS for the five cases over full equivalent cycles.

cell technologies. Therefore, in addition to the economic assessment on the original case, we also present a sensitivity analysis of degradation where the BESS is not replaced. Further, the authors of this study suggest to integrate a NCA BESS model to SimSES based on more recent battery cells.

Fig. 17 displays the SOC of the BESS over a single year for all five cases. It is clear from the figure that in Case 1 the BESS is used very little compared with the other cases, and the SOC maintains a level of about 0.95 for most of the time, dropping to 0.05 only when football matches are played. The SOC profiles for Cases 2 and 3 are very similar, reflecting the near similarity of their operation strategies. In these cases, the average SOC is 0.2. In Case 4, the average SOC is 0.4. Note that in Cases 2, 3 and 4, the BESS is used very little in the winter, probably because the PV production is low. In Case 5, the BESS is used all year round as a consequence of taking the capacity-based grid tariff into account. The mean SOC for Case 5 is 0.2.

4.2. Energy flow in the system

Fig. 18 shows the total feed-in energy to the grid for the ten-year analysis period. In Case 1 this amounts to approx. 3000 GWh, which is to be expected because the load in this case is allocated exclusively to the flood-lighting. Cases 4 and 5 exhibit feed-in energies of 779 and 971 GWh, respectively. Cases 2 and 3 exhibit lower feed-in energies of 424 and 461 GWh, respectively, which is also to be expected due to their

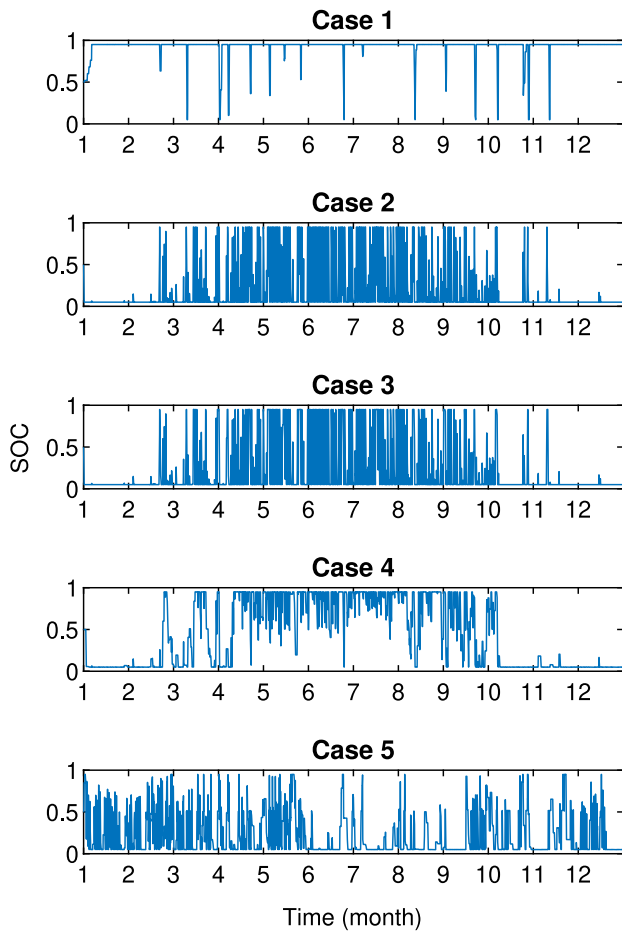

Fig. 17. State of charge (SOC) of the BESS for the five cases for a single year.

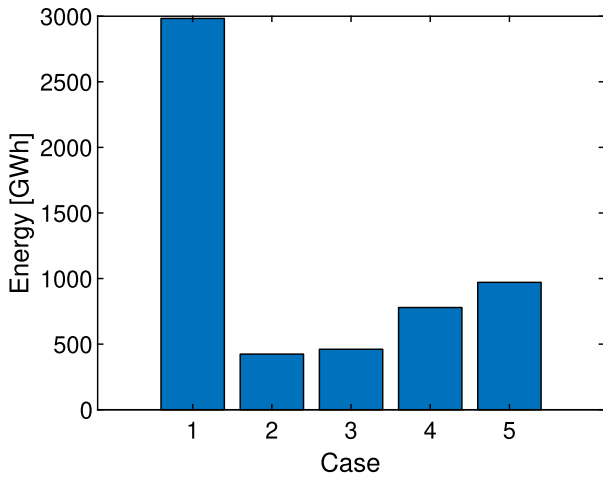

Fig. 18. Feed-in energy for the five cases for ten-year analysis period.

self-consumption maximisation strategies that minimise the amount of PV generation entering the grid.

Fig. 19 shows the total energy charged by the BESS and the total losses resulting from its charging and discharging.

There is a natural correlation between the energy used to charge the BESS and its subsequent losses. In Cases 2 and 3 the BESS is charged with 553 and 544 GWh, respectively. These values are higher than in Case 5, where the value is 441 GWh. Case 1 involves charging with only 57 GWh, while the value for Case 4 is 208 GWh. Cases 2 and 3 exhibit

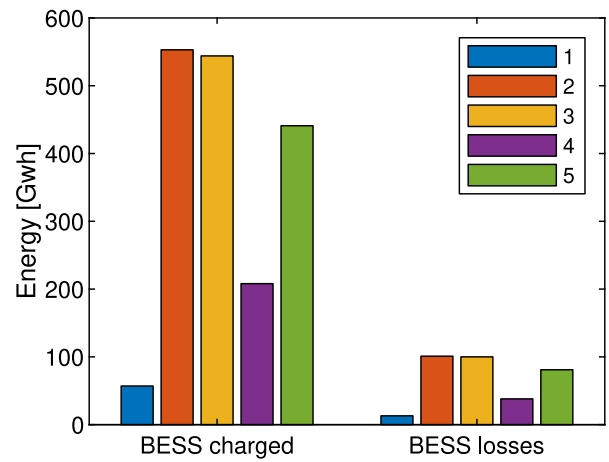

Fig. 19. Energy charged by the BESS and energy losses for the five cases for ten-year analysis period.

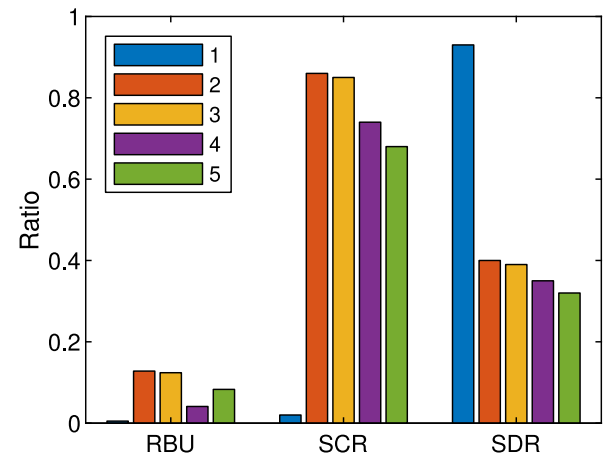

Fig. 20. Relative KPIs for the five cases for ten-year analysis period.

the highest levels of losses of all five cases, amounting to approximately 100 GWh, while Case 5 exhibits 81 GWh. Cases 1 and 4 exhibit losses of 13 and 38 GWh, respectively.

4.3. Relative key-performance indicators

A plot of the relative KPIs described previously in Section 2.7 are shown in Fig. 20. As previously discussed, and illustrated in Figs. 19 and 17, the BESS was only rarely used in Cases 1 and 4, resulting in RBU values of 0.005 and 0.041, respectively. The BESS was most extensively used in Cases 2 and 3, resulting in RBU values of 0.128 and 0.124, respectively. The RBU for Case 5 is 0.083. All cases exhibit an RBU value of less than 0.13, indicating that the BESS was used for less than 13% of the time.

Since in Case 1, the load was allocated exclusively to cover flood-lighting, the SCR value is 0.02. Cases 2 and 3 exhibit the highest values for SCR (0.86 and 0.85, respectively). This is as expected because of their self-consumption maximisation operation strategies. The SCR for Cases 4 and 5 are 0.74 and 0.68, respectively.

The SDR is clearly highest in Case 1 (0.93), which is to be expected due to the load difference. Cases 2 to 5 exhibit SDR values of 0.4, 0.39, 0.35 and 0.32, respectively.

In terms of the KPIs, it is interesting to compare Cases 4 and 5: Case 4 exhibits a lower RBU, but higher SCR and SDR values than Case 5. Case 5 probably exhibits a higher RBU because the BESS is used

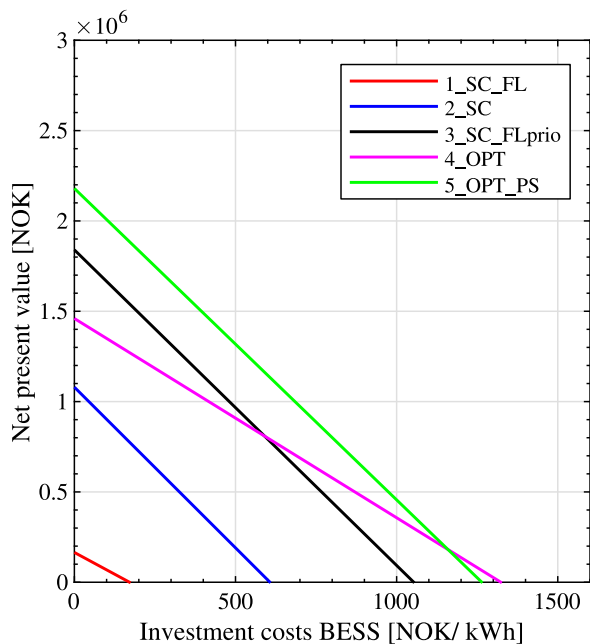

Fig. 21. A comparison of NPV for the five cases.

to cover peaks and thus has a greater need than in Case 4 to charge from the grid between the peaks. Case 4 exhibits higher SCR and SDR values because more of the PV power is used to cover the load, and a greater proportion of the load is thus covered by PV power. In Case 5, the battery is used to peak shave, and is thus more dependent on the purchase of electricity from the grid in order to recharge.

5. Economic assessment

For all five cases, an economic assessment has been carried out in the form of an NPV calculation, as described in Section 2.6. The NPV calculation enables us to determine the break-even cost of the BESS. Thus, for a case to be financially viable, it is a minimum requirement that the NPV is equal to zero. The NPVs are calculated by applying (11) and using the parameters and assumptions listed in Table 4. It is assumed that the cost of investment in a BESS is between 4000 NOK/kWh and 10,000 NOK/kWh for a 1 MWh/1 MW BESS [3,4].

The SOH impact of replacing a BESS for the five cases is shown in Fig. 15. For Cases 2, 3 and 5, the calendric and cyclic ageing processes inherent in the NCA model require a replacement of the BESS within the ten-year analysis period.

5.1. Variation of the investment cost parameter

Fig. 21 shows how the NPV varies with investment cost of the BESS. If we assume investment in a BESS of 4000 NOK/kWh, none of the cases are profitable. The best result is for Case 4, which achieves an NPV of zero for an investment cost of 1320 NOK/kWh.

5.2. Sensitivity analysis of degradation

Battery technology is evolving very rapidly, and there probably exist different battery models that exhibit slower degradation rates than the NCA Li-ion model used in these case simulations. In order to demonstrate how this would impact on the economic assessment, a sensitivity analysis was performed in which it was assumed that the BESS did not require replacement in any of the five cases. (In the first instance, replacement was required in Cases 2, 3 and 5). The results of this assumption are shown in Fig. 22, in which the stippled lines indicate NPV development for Cases 2, 3 and 5 without battery

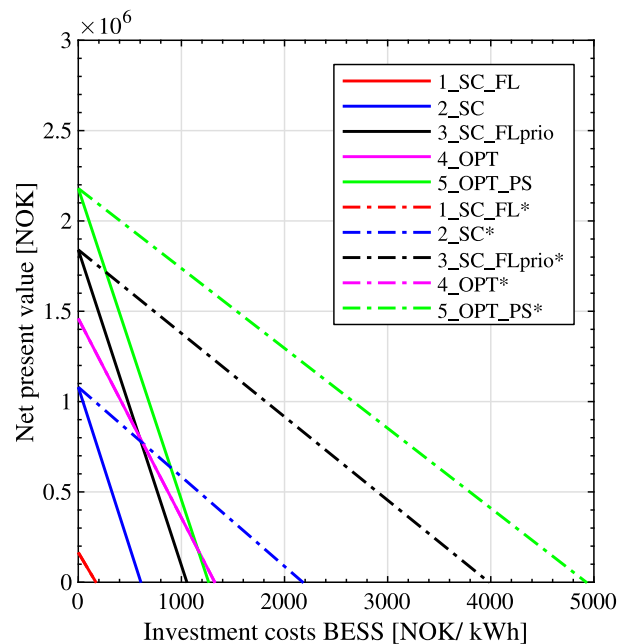

Fig. 22. A comparison of NPV for the five cases, including a sensitivity analysis involving no replacement of the BESS for Cases 2, 3 and 5 (stippled lines).

replacement. In Cases 1 and 4, the solid and stippled lines are identical. Without replacement costs, we can see that both Cases 3 and 5 could be profitable, achieving zero NPV at investment costs of 3980 and 4930 NOK/kWh, respectively.

5.3. Sensitivity analysis of PV system costs

Since PV system costs are decreasing, it is possible that this may also affect the economic assessment. In order to test this, another sensitivity analysis was performed in which the PV system costs were set to zero, in contrast to the original value of 1000 NOK/kWp that was used in the main simulations. In this analysis, the replacement costs of the BESS in Cases 2, 3 and 5 were included. The outcome of the sensitivity analysis is illustrated in 23, from which we can see that Case 4 is the most optimal, achieving an NPV of zero for an investment cost of 6430 NOK/kWh. Cases 1, 3 and 5 also achieve zero NPV following investment costs of greater than 4000 NOK/kWh.

5.4. Theoretical best case

In Fig. 24, both sensitivity analyses are combined, showing the NPV obtained if there is no replacement of the BESS and with PV system costs set to zero. Cases 2, 3 and 5 achieve zero NPV for BESS investment costs of 13,460 NOK/kWh, 16,060 NOK/kWh and 17,530 NOK/kWh, respectively. In other words, if we assume a maximum investment cost of 10,000 NOK/kWh, these cases are very likely to be profitable.

6. Discussion

Since Case 1 was considered primarily as a reference case, with the load allocated exclusively to flood-lighting, we will restrict our discussion to the four remaining cases.

6.1. Technical assessment

The technical assessment demonstrated that when the BESS is used to maximise self-consumption, as in Case 2, high SCR and SDR values (0.86 and 0.4) are obtained. There is little feed-in energy to the grid

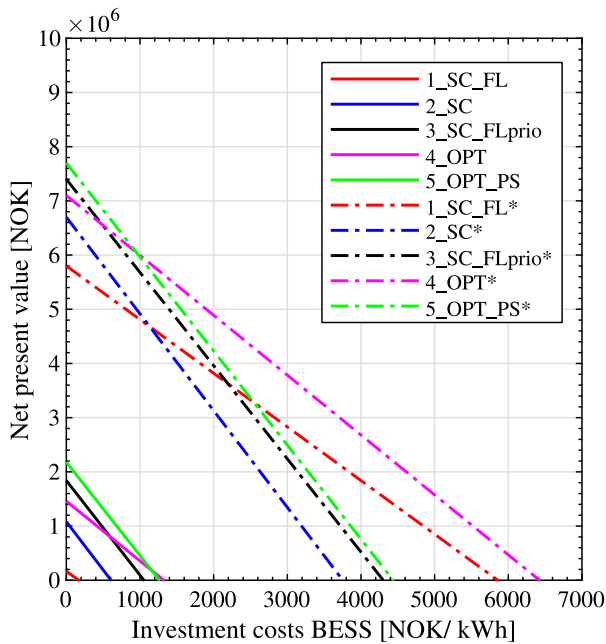

Fig. 23. A comparison of NPV for the five cases, including a sensitivity analysis in which PV system costs are set to zero (stippled lines).

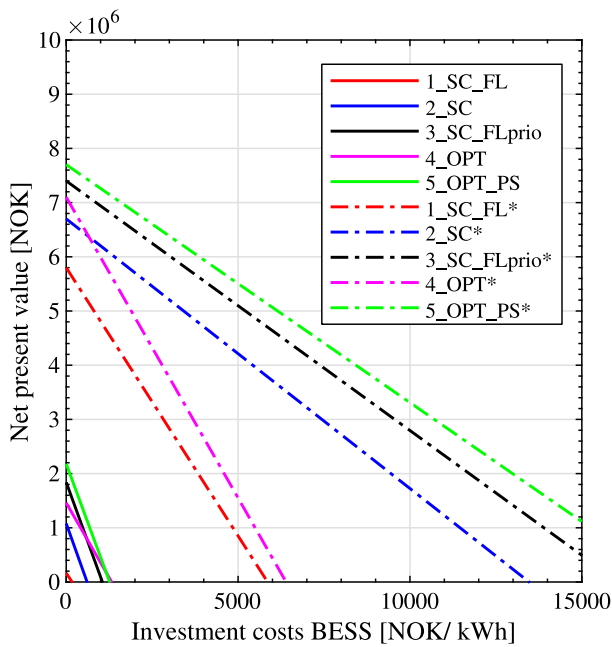

Fig. 24. A comparison of NPV for the five cases, including a combined sensitivity analysis showing the theoretical best case following no replacement of the BESS and PV system costs set to zero (stippled lines).

(424 GWh) and a high RBU value (0.128) is achieved. This in turn resulted in the most rapid rate of battery degradation, and replacement of the battery after 8.3 years. When the BESS is used for self-consumption maximisation with the flood-lighting as priority (Case 3), the technical results are quite similar to those for Case 2, as we might expect. The only differences are that the RBU, SCR and SDR values are somewhat lower in Case 3, and the battery replacement occurs after 8.5 years.

In Case 4, the BESS was used for energy arbitrage, with use being governed by electricity spot prices, though without consideration of the capacity-based grid tariff. Compared with Cases 2 and 3, the technical

assessment showed that feed-in energy to the grid increased (779 GWh). The RBU value (0.041) is lower than for Cases 2 and 3, as are the SCR (0.74) and SDR (0.35) values. Fig. 12 demonstrates that the variation in electricity price is unlikely to be high enough to generate benefits from using the BESS exclusively for energy arbitrage, due to the losses resulting from charging and discharging. This result coincides with an analysis of the marginal cost of BESS usage for energy arbitrage described in [16]. This study shows that in most markets the costs resulting from energy losses and battery degradation are too high to be covered by possible revenues. Since the RBU value is low, Case 4 exhibits the slowest degradation rate, reaching a SOH value of 0.826 after ten years.

Case 5 ran with an operation strategy that combined the powering of most services, while simultaneously aiming to minimise all costs, including the capacity-based grid tariff. This resulted in the highest levels of feed-in energy (971 GWh). The RBU value of 0.083 is lower than in Cases 2 and 3, but higher than in Case 4. The SCR and SDR values are the lowest of all. The battery degrades faster than in Case 4, but degradation is slower than for Cases 2 and 3, resulting in a battery replacement after 8.7 years.

On the basis of the technical assessment, Case 4 appears to be the best option, not least because it exhibits the slowest degradation of the BESS. Since we are assuming that the BESS is located at, and operated by, the stadium, we may assume that it is important to have a high SCR. If the BESS was owned and operated by a DSO, it would probably be more important to reduce the feed-in power to the grid. Thus would, for example, enable the avoidance of over-voltage issues in summer.

6.2. Economic assessment

The technical assessment was used as input to the economic assessment, which is the main outcome of this study. An NPV analysis was performed for all cases, resulting in a break-even cost of the BESS. For a case to be financially viable, it is a minimum requirement that the NPV is equal to zero.

As we demonstrated in Section 5, none of the cases are profitable if we assume a BESS investment cost of between 4000 and 10,000 NOK/kWh (Fig. 21). In Cases 2, 3 and 5, the BESS had to be replaced. Case 4 revealed to be the most profitable, with an investment cost of 1320 NOK/kWh, but still failed to achieve break-even criteria, even at current battery prices.

The first sensitivity analysis showed that if the BESS does not need replacement during the ten-year analysis period, Cases 4 and 5 may be profitable, assuming a BESS investment cost of between 4000 and 10,000 NOK/kWh (Fig. 22). Case 5 was the most profitable, achieving zero NPV with an investment cost of 4930 NOK/kWh. In other words, profitability depends on the operation strategy of the BESS in combination with its battery technology. The sensitivity analyses of BESS replacement indicated that ageing processes have a major impact on profitability, and should play an important role in terms of dispatch decisions and profitability evaluation. This conclusion is in stark contrast to other battery technologies, such as vanadium-redox-flow BESS, for which ageing plays no significant role [42]. This kind of technology may be preferred in cases where BESS replacement is required due to ageing.

The second sensitivity analysis, illustrated in Fig. 23, demonstrated that if PV system costs decrease, all cases, with the exception of Case 2, might be profitable, assuming a BESS investment cost of between 4000 and 10,000 NOK/kWh. Case 4 was the most profitable, achieving zero NPV at an investment cost of 6430 NOK/kWh.

The sensitivity analysis in which both PV system costs and BESS replacement cost were set to zero was considered to be the theoretical best case (see Fig. 24). Case 5 was revealed to be the most profitable scenario, achieving zero NPV at an investment cost of 17,530 NOK/kWh. This indicates that an operation strategy that combines

several objectives is more profitable than single-purpose strategies, even though it may result in higher degradation.

Our study shows that with future battery prices and a battery technology which does not require BESS replacement, energy arbitrage might become profitable in Norway. Energy arbitrage might be even more profitable in countries that have a more fluctuating electricity spot price. In [43], it was reported that the average electricity spot price in Germany was 29 EUR/MWh in 2016. This corresponds to 322 NOK/MWh, which is similar to the previously mentioned average spot price in Norway for the last five years. More interesting, the paper also reports the difference between the daily minimum and maximum electricity price. The majority of the days have a difference in electricity price of between 15 and 45 EUR/MWh, corresponding to 166 and 500 NOK/MWh, respectively. As shown in Fig. 13, the difference between the 9th and the 91st percentile was only 121 NOK/MWh for 2018 in Norway. In other words, these variations in electricity spot price support the idea that Cases 4 and 5, which include arbitrage in our study, might be even more profitable in a different country.

The main conclusion from the economic assessment is that it is highly recommended to use the BESS for multiple services. Such a use results in a more rapid degradation, which entails a replacement cost, but it also provides more savings on grid tariffs. Our study indicates that these savings will be higher than the cost of replacing the BESS.

7. Conclusion and further work

In this paper, we have described a techno-economic analysis carried out on the BESS installed at the Skagerak EnergyLab pilot. The aim of our study has been to analyse the performance of the existing installation by investigating a number of cases employing a variety of operation strategies for peak shaving, self-consumption maximisation, energy arbitrage and feed-in limitation. The software tool SimSES was used to simulating BESS degradation. A perfect forecast of electricity pricing was assumed, such that the results can be regarded as the best case.

The results from this study can be applied to other large-scale BESS applications with high load peaks that occur for only a limited number of hours during the year. More specifically, the use of a BESS in a sports stadium has great potential. As mentioned previously in the introduction, there are 948 football stadiums in the EU, where diesel backup generators could be replaced by a BESS.

In conclusion, an important outcome of this work is that a BESS that provides stacked value by combining peak shaving, energy arbitrage and self-consumption, as a replacement for a backup diesel generator, may represent a feasible option in Norway. However, there are a number of research topics that we believe should be given further consideration:

- Techno-economic analyses for different degradation models and lithium-ion battery types, especially based on NMC or LFP cells.
- The inclusion of more services in operation strategies, e.g. frequency control reserve.
- Investigations of how different BESS sizes would have influenced the techno-economic analysis.
- A comparison with results of BESS use in stadiums in other countries operating with different tariffs, spot prices and load.
- The inclusion of uncertainties in load, generation and spot price forecast parameters.
- Our economic evaluation demonstrated that the operation strategy combining the most services was the most profitable. A BESS that combines more services requires a more sophisticated control system, and it will be fruitful to investigate how such a scenario may affect the economic evaluation.

CRedit authorship contribution statement

Kjersti Berg: Conceptualization, Methodology, Writing - original draft, Visualization, Project administration. **Matthias Resch:** Writing - original draft, Visualization, Software, Formal analysis. **Thaddäus Weniger:** Methodology, Software, Writing - review & editing. **Stig Simonsen:** Conceptualization, Validation, Funding acquisition.

Declaration of competing interest

The authors declare that they have no known competing financial interests or personal relationships that could have appeared to influence the work reported in this paper.

Acknowledgements

This research study was funded by the Research Council of Norway and a private sector consortium in support of the research project “Integration of energy storage in the distribution grid” (IntegER, project number 269420, ENERGIX programme). Publication was funded by the research centre CINELDI (Centre for intelligent electricity distribution, project number 257626/E20, FME programme) and the research project ModFlex (Modelling Flexible Resources in Smart Distribution Grid, project number 255209, ENERGIX programme). The authors are grateful to Maren Istad, Nancy Eik-Nes, Bendik N. Torsæter, Hanne Sæle and Maren R. Brubæk for their valuable discussions and proofreading.

Appendix A. Supplementary data

Supplementary material related to this article can be found online at <https://doi.org/10.1016/j.est.2020.102190>.

References

- [1] J. Figgenger, P. Stenzel, K.-P. Kairies, J. Linßen, D. Haberschusz, O. Wessels, G. Angenendt, M. Robinius, D. Stolten, D.U. Sauer, The development of stationary battery storage systems in Germany – a market review, *J. Energy Storage* 29 (2020) 101153, [Online]. Available: <http://www.sciencedirect.com/science/article/pii/S2352152X19309442>.
- [2] P. Ahcin, K. Berg, I. Petersen, Techno-economic analysis of battery storage for peak shaving and frequency containment reserve, in: 16th European Energy Market Conference, Ljubljana, Slovenia, 2019.
- [3] T. Terlouw, T. AlSkaif, C. Bauer, W. van Sark, Multi-objective optimization of energy arbitrage in community energy storage systems using different battery technologies, *Appl. Energy* 239 (2019) 356–372.
- [4] National Rural Electric Cooperative Association, Battery Energy Storage Overview, Tech. Rep., National Rural Utilities Cooperative Finance Corporation and CoBank and NRTC, 2019.
- [5] K. Mongird, V. Viswanathan, P. Balducci, J. Alam, V. Fotedar, V. Koritarov, B. Hadjerioua, Energy Storage Technology and Cost Characterization Report, Tech. Rep., US Department of Energy, 2019.
- [6] M. Naumann, R.C. Karl, C.N. Truong, A. Jossen, H.C. Hesse, Lithium-ion battery cost analysis in PV-household application, *Energy Procedia* 73 (2015) 37–47.
- [7] C. Jankowiak, A. Zacharopoulos, C. Brandoni, P. Keatley, P. MacArtain, N. Hewitt, Assessing the benefits of decentralised residential batteries for load peak shaving, *J. Energy Storage* 32 (2020) 101779, [Online]. Available: <http://www.sciencedirect.com/science/article/pii/S2352152X20316169>.
- [8] C. Lehmann, M. Weeber, J. Böhner, R. Steinhilper, Techno-economical analysis of photovoltaic-battery storage systems for peak-shaving applications and self-consumption optimization in existing production plants, *Procedia CIRP* 48 (2016) 313–318, [Online]. Available: <https://linkinghub.elsevier.com/retrieve/pii/S2212827116006545>.
- [9] F. Wankmüller, P.R. Thimmapuram, K.G. Gallagher, A. Botterud, Impact of battery degradation on energy arbitrage revenue of grid-level energy storage, *J. Energy Storage* 10 (2017) 56–66, [Online]. Available: <http://www.sciencedirect.com/science/article/pii/S2352152X16303231>.
- [10] R. Martins, H. Hesse, J. Jungbauer, T. Vorbuchner, P. Musilek, Optimal component sizing for peak shaving in battery energy storage system for industrial applications, *Energies* 11 (8) (2018) 2048.
- [11] A. Maheshwari, N.G. Paterakis, M. Santarelli, M. Gibescu, Optimizing the operation of energy storage using a non-linear lithium-ion battery degradation model, *Appl. Energy* 261 (2020).

- [12] D. Rosewater, D.A. Copp, T.A. Nguyen, R.H. Byrne, S. Santoso, Battery energy storage models for optimal control, *IEEE Access* 7 (2019) 178357–178391.
- [13] R. Byrne, T.A. Nguyen, D.A. Copp, B.R. Chalamala, I. Gyuk, Energy management and optimization methods for grid energy storage systems, *IEEE Access* 6 (2018) 13231–13260.
- [14] C. Ju, P. Wang, L. Goel, Y. Xu, A two-layer energy management system for microgrids with hybrid energy storage considering degradation costs, *IEEE Trans. Smart Grid* 9 (6) (2018) 6047–6057.
- [15] C.S. Lai, Y. Jia, Z. Xu, L.L. Lai, X. Li, J. Cao, M.D. McCulloch, Levelized cost of electricity for photovoltaic/biogas power plant hybrid system with electrical energy storage degradation costs, *Energy Convers. Manage.* 153 (October) (2017) 34–47, [Online]. Available: <https://doi.org/10.1016/j.enconman.2017.09.076> <https://linkinghub.elsevier.com/retrieve/pii/S0196890417309019>.
- [16] M. Schimpe, C.N. Truong, M. Naumann, A. Jossen, H.C. Hesse, J.M. Reniers, D.A. Howey, Marginal costs of battery system operation in energy arbitrage based on energy losses and cell degradation, in: 2018 IEEE International Conference on Environment and Electrical Engineering and 2018 IEEE Industrial and Commercial Power Systems Europe (IEEEIC / I&CPS Europe), IEEE, Palermo, 2018, pp. 1–5, [Online]. Available: <https://ieeexplore.ieee.org/document/8493717/>.
- [17] M. Klausen, M. Resch, J. Bühler, Analysis of a potential single and combined business model for stationary battery storage systems, *Energy Procedia* 99 (2016) 321–331.
- [18] C. Goebel, H. Hesse, M. Schimpe, A. Jossen, H.-A. Jacobsen, Model-based dispatch strategies for lithium-ion battery energy storage applied to pay-as-bid markets for secondary reserve, *IEEE Trans. Power Syst.* 32 (4) (2017) 2724–2734.
- [19] S. Englberger, H. Hesse, N. Hanselmann, A. Jossen, Simses multi-use : A simulation tool for multiple storage system applications, in: 16th International Conference on the European Energy Market (EEM), IEEE, Ljubljana, 2019, pp. 1–5.
- [20] T. Vo, P. Nguyen, Amsterdam arena stadium: Real-time smart battery energy storage system coordination for voltage support, in: 2018 IEEE Power Energy Society General Meeting (PESGM), 2018, pp. 1–5.
- [21] M.M. Ortiz, I. Petersen, R. Mikut, H. Landsverk, S.H. Simonsen, Power Quality in Smart Distribution Systems with Electric Battery, Large Loads and PV Generation, Atlantis Press, 2019, pp. 97–108, [Online]. Available: <https://www.atlantispress.com/proceedings/ires-19/125923322>.
- [22] Statnett, Tariffer for transmijonsnett 2019 - modellbeskrivelse og satser, Report, 2019, [Online]. Available: <https://www.statnett.no/globalassets/foraktorer-i-kraftsystemet/tariff/tariffhefte-2019.pdf>.
- [23] BKK, Prisoversikt for effektmålte anlegg fra 1. januar 2019, 2019, [Online]. Available: <https://www.bkk.no/nett/nettleiepriser-tariffer-og-avgifter> (Accessed: 2020-06-01).
- [24] C. Rosenkranz, A. Köhler, U. Liska, Modern battery systems for plug-in hybrid electric vehicles, in: 23rd International Battery, Hybrid and Fuel Cell Electric Vehicle Symposium and Exhibition, Anaheim, USA, 2007.
- [25] M. Killer, M. Farrokhsersht, N.G. Paterakis, Implementation of large-scale Li-ion battery energy storage systems within the EMEA region, *Appl. Energy* 260 (2020).
- [26] HTW, Performance-simulationsmodell für AC-gekoppelte PV-batteriesysteme (PerModAC), 2017, [Online]. Available: <https://pvspeicher.htw-berlin.de/veroeffentlichungen/daten/permodac/> (Accessed: 2020-06-01).
- [27] Electric Power Research Institute, Storage value estimation tool (StorageVET), 2020, [Online]. Available: <http://www.storagevet.com/> (Accessed: 2020-06-01).
- [28] National Renewable Energy Laboratory, Blast: Battery lifetime analysis and simulation tool suite, 2020, [Online]. Available: <https://www.nrel.gov/transportation/blast.html> (Accessed: 2020-06-01).
- [29] HOMER Energy, HOMER energy, 2020, [Online]. Available: <https://www.homerenergy.com/> (Accessed: 2020-06-01).
- [30] National Renewable Energy Laboratory, Technoeconomic Modeling of Battery Energy Storage in SAM, Tech. Rep., 2015.
- [31] M. Naumann, C.N. Truong, M. Schimpe, D. Kucevic, A. Jossen, H.C. Hesse, SimSES: Software for techno-economic simulation of stationary energy storage systems, 2017.
- [32] M. Naumann, Techno-Economic Evaluation of Stationary Battery Energy Storage Systems with Special Consideration of Aging (Ph.D. thesis), 2018.
- [33] V. Kumtepe, Y. Zhao, M. Naumann, A. Tripathi, Y. Wang, A. Jossen, H. Hesse, Design and analysis of an aging-aware energy management system for islanded grids using mixed-integer quadratic programming, *Int. J. Energy Res.* 43 (9) (2019) 4127–4147, [Online]. Available: <https://onlinelibrary.wiley.com/doi/abs/10.1002/er.4512>.
- [34] A. Zeh, M. Müller, M. Naumann, H. Hesse, A. Jossen, R. Witzmann, Fundamentals of using battery energy storage systems to provide primary control reserves in Germany, *Batteries* 2 (2016).
- [35] J. Bergner, Untersuchungen zu prognosebasierten Betriebsstrategien für PV-Speichersysteme Bachelor Thesis, Hochschule für Technik und Wirtschaft Berlin [University of Applied Sciences], 2014.
- [36] M. Schimpe, M.E. von Kuepach, M. Naumann, H.C. Hesse, K. Smith, A. Jossen, Comprehensive modeling of temperature-dependent degradation mechanisms in lithium iron phosphate batteries, *J. Electrochem. Soc.* 165 (2) (2018) A181–A193.
- [37] B. Boeckl, T. Kienberger, Sizing of PV storage systems for different household types, *J. Energy Storage* 24 (2019) 100763.
- [38] B. Xu, A. Oudalov, A. Ulbig, G. Andersson, D.S. Kirschen, Modeling of lithium-ion battery degradation for cell life assessment, *IEEE Trans. Smart Grid* 9 (2) (2018) 1131–1140.
- [39] F. Yang, Y. Xie, Y. Deng, C. Yuan, Predictive modeling of battery degradation and greenhouse gas emissions from U.S. state-level electric vehicle operation, *Nature Commun.* 9 (1) (2018) 1–10, [Online]. Available: <http://dx.doi.org/10.1038/s41467-018-04826-0>.
- [40] S. Englberger, H. Hesse, D. Kucevic, A. Jossen, A techno-economic analysis of vehicle-to-building: Battery degradation and efficiency analysis in the context of coordinated electric vehicle charging, *Energies* 12 (5) (2019) 955, [Online]. Available: <https://www.mdpi.com/1996-1073/12/5/955>.
- [41] P. Keil, A. Jossen, Calendar aging of NCA lithium-ion batteries investigated by differential voltage analysis and Coulomb tracking calendar aging of NCA lithium-ion batteries investigated by differential voltage analysis and Coulomb tracking, *J. Electrochem. Soc.* 164 (A6066) (2017).
- [42] M. Resch, J. Bühler, B. Schachler, R. Kunert, A. Meier, A. Sumper, Technical and economic comparison of grid supportive vanadium redox flow batteries for primary control reserve and community electricity storage in Germany, *Int. J. Energy Res.* 43 (1) (2018) 337–357.
- [43] D. Metz, J.T. Saraiva, Use of battery storage systems for price arbitrage operations in the 15- and 60-min german intraday markets, *Electr. Power Syst. Res.* 160 (2018) 27–36, [Online]. Available: <https://linkinghub.elsevier.com/retrieve/pii/S0378779618300282>.