



ANNUAL REPORT 2019

CINELDI
Centre for intelligent electricity distribution

Selected highlights from 2019

CINELDI

- CINELDI develops the electricity grid of the future.
- CINELDI works towards digitalising and modernising the electricity distribution grid for higher efficiency, flexibility and resilience.
- CINELDI will enable a cost-efficient realisation of the future flexible and robust electricity distribution grid.

CONTENTS

Heading for the future electricity distribution grid, one scenario at a time **10** Vision, mission and goals **14**
 A Structured Look at Specific Smart Grid Scenarios **17** Testing a battery that feeds the grid **20**
 The big “living” energy lab **24** Research and innovation strategy **28** EV Power Share Charging System **30**
 Organisation **32** Research Activities and Results **36** Pilot projects in CINELDI **58** International cooperation **61**
 Recruitment **64** Communication **66** Appendix 1: Personnel **71** Appendix 2: Statement of Accounts **76**
 Appendix 3: Publications **77**

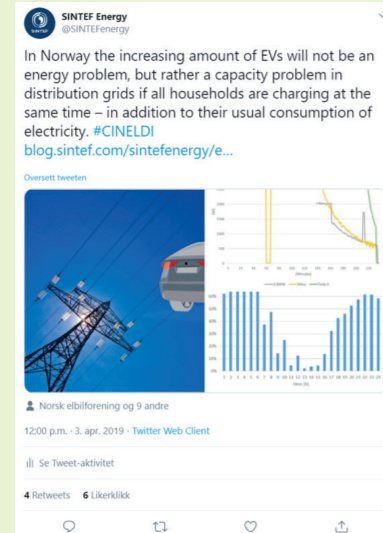
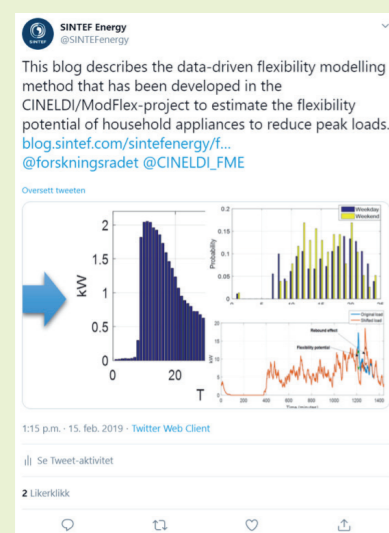

February

April

June

September

November

December

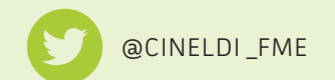

All pictures without reference to another source is property of SINTEF.

CINELDI BY NUMBERS



30 PARTNERS



8 YEARS



365 MNOK

Visibility 2019

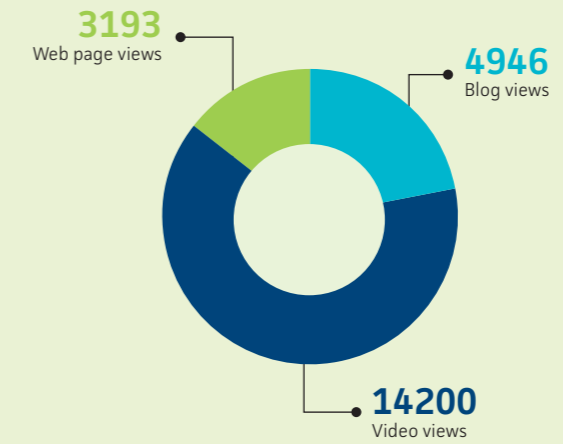

People

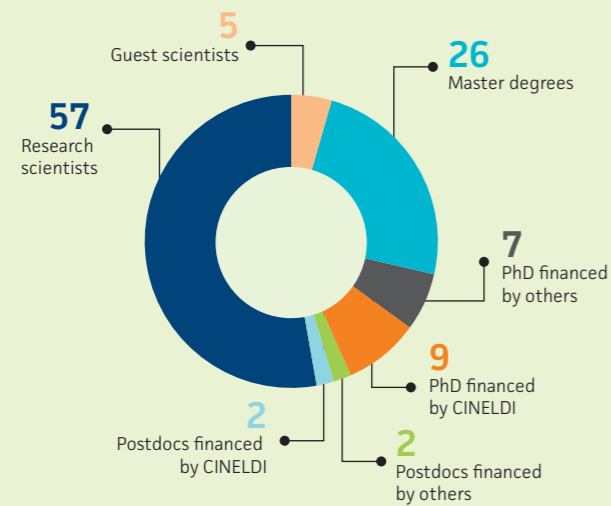

194 USER PARTNER PARTICIPANTS

Communication and dissemination 2019*

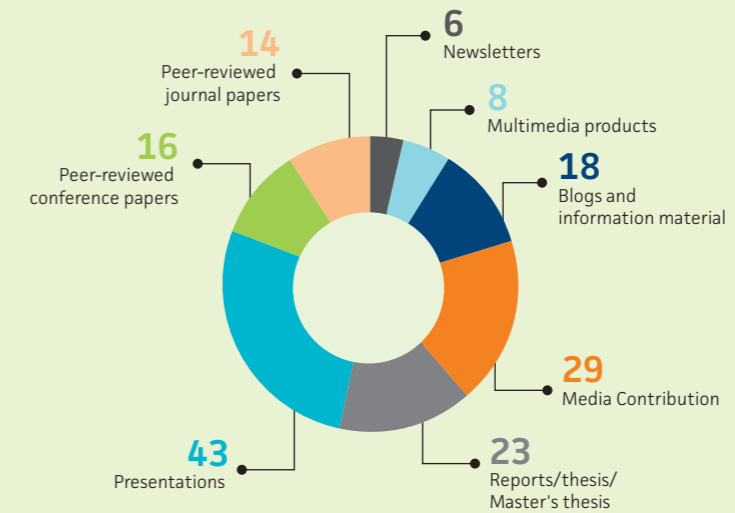

* There might be some discrepancies between the numbers in figure and numbers registered in Cristin, mainly due to FME partners that do not have a university or research institute affiliation or because the FME projectcode has not yet been registered in the post.

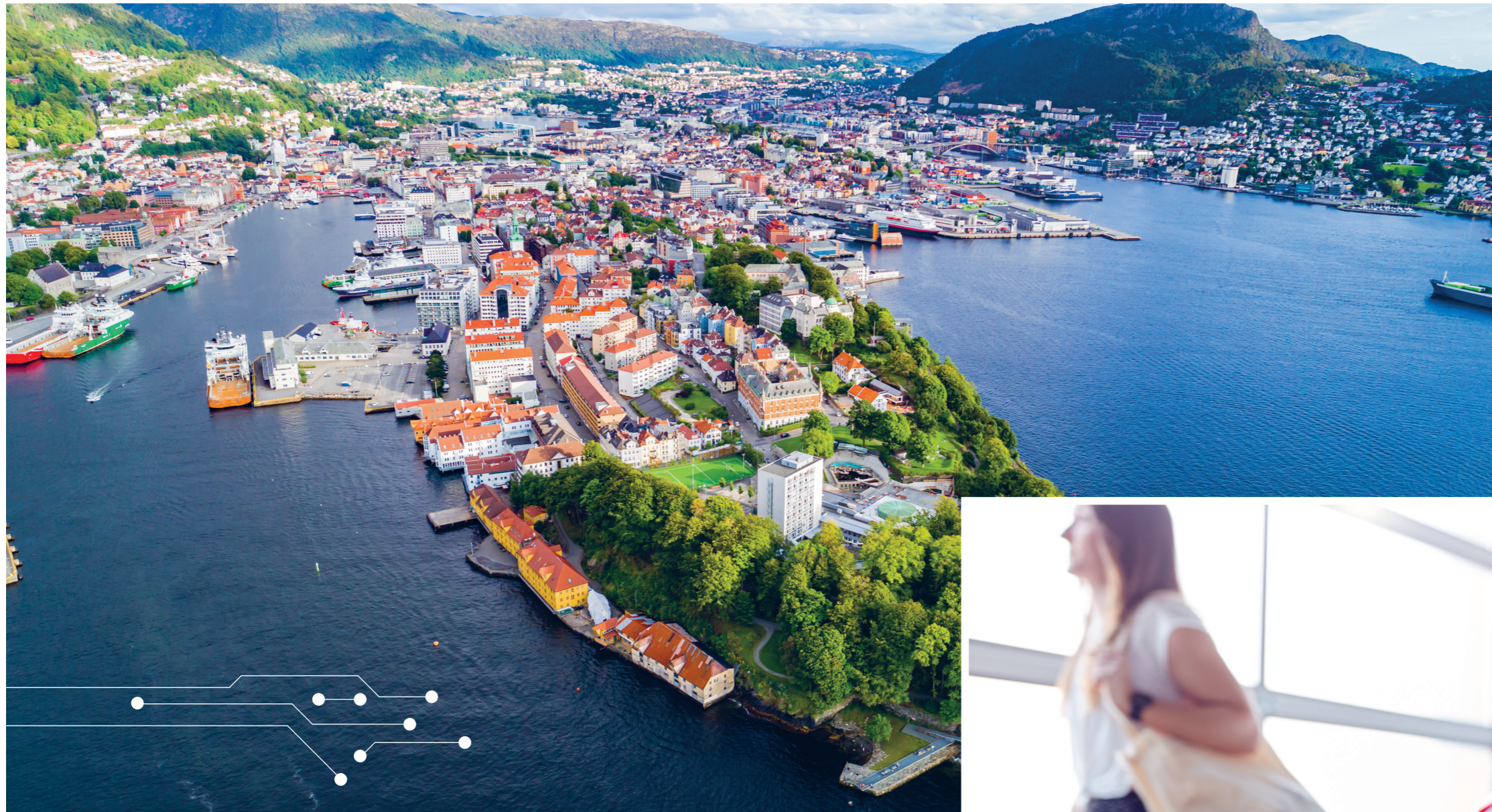

Keeping solar and wind energy stored in the battery: What is the value?

It is expected that operation and planning of electricity distribution systems is going to make more use of flexible resources, such as end-user flexibility (demand response), battery storage systems and electric vehicles. The flexible resources may among other things contribute to handling an increasingly variable renewable energy being integrated in the distribution system, such as photovoltaic solar energy. Optimal use of flexible resources requires a foresighted form of operational planning where one accounts for the value of having available flexibility in the future.

Find out more: www.cineldi.no
– Annual report 2019

Finding Smart Grid driving forces and how they affect Smart Grid development

What might the Smart Grid look like? What are the driving forces influencing the development of the Norwegian grid? And what might we need to do in order to push the development in a preferable direction? To better understand the complexity of the future Norwegian distribution grid we have identified driving forces for system innovation in the distribution grid (smart grid driving forces). Based on this, we are developing a set of credible scenarios for the electricity distribution system in Norway.

Find out more www.cineldi.no – Annual report 2019





Smart grid monitoring: new opportunities and challenges with digitalization and 5G integration

The transition from the traditional power distribution grid to a digitalized distribution grid is mainly driven by the inclusion of distributed and highly fluctuating energy resources (e.g. solar, wind) and the increasing electrification, e.g. of the transport sector. The Smart Grid will help to realise the flexibility resources inherent in electricity consumption, production and storage. The use of new sensors and smart components and communication makes it possible to monitor and operate the electricity grid in new ways - to improve usage of the existing grid and reduce the need for investments.

Find out more: www.cineldi.no – Annual report 2019

HEADING FOR THE **FUTURE** ELECTRICITY DISTRIBUTION GRID, ONE SCENARIO AT A TIME



Gerd Kjølle, Chief Scientist, SINTEF Energy Research, Director FME CINELDI.

The future is hard to predict. But we know that things will change. Especially when it comes to technology.

Whether it's new ways of charging our vehicles, powering our appliances or radical innovations that have yet to be seen, we can be certain of one thing; the electricity distribution grid will have to adapt. Varying power loads, uncertainties and an ever-increasing amount of connections to the grid will all contribute in making change a necessity. Is it challenging? Yes. But, with challenge comes opportunity, and with opportunity comes innovation.

Developing the electricity grid of the future

Since the early stages of the Centre, the vision has always been clear.

Through collaboration with some of the largest grid companies in Norway, CINELDI has been working towards fitting the grid for use by Smart Grid

customers, electric vehicles, solar power facilities and other renewable sources for electric power. We define a Smart Grid as an intelligent grid, that is flexible, robust and cost efficient.

So far, the Centre has fostered excellent research aimed at tailoring the grid for the future, whilst creating a solid arena for networking, collaboration and value creation. Some of the results have already made practical impacts on the industry.

"We hope that CINELDI will help us navigate the unpredictable future of new technologies, renewable distributed generation and new business models. I think the Centre can help us create more value by testing Smart Grid solutions in both laboratories and real-life environments. The research gives us knowledge that can help us in developing and integrating new technologies, work processes, and, hopefully, more innovations," explains Sigurd Kvistad, Chair of the CINELDI Board.

Kvistad, who works at the grid company Elvia, believes that the Centre's research has already been of great value to the industry.

"So far, the Centre's biggest contribution for the industry has been through the "mini scenarios", which helps compare and contrast different technologies' influence on the development of power grid companies over the next years and decades."

It's clear that the Centre has covered valuable ground in its starting years, proving early on that research and

real-life pilot-testing gives practical knowledge that push the entire industry towards a smarter and more efficient future. Looking back at 2019, CINELDI Director Gerd Kjølle shares some of her personal highlights of the year.

"Some of our most important work this year was on *driving forces* (key internal and external forces affecting the development of the grid, such as knowledge and competence, economy and technology), for which we finished a report. The mapping of driving forces for Smart Grid development provided imperative insight as we continued our work on the *mini scenarios*. Based on the mini scenarios we have also started working on what we call the *main scenarios*. They will provide insight for the future research in CINELDI and help grid companies in their strategic planning for the years to come".

Gerd goes on to list an impressive number of examples of the work done in 2019, from identifying vulnerabilities and risks related to cyber security, controllers for testing microgrids in labs, to pilot projects in the real distribution grid, for example testing of battery as voltage support in the grid at Lyse Elnett. "We have around 20 pilot projects up and running, and several PhDs are about to finish their work. It has been a challenging year in many ways, but we have succeeded with many good results."

For 2020, the Centre's focus is to maintain its current course with the plethora of pilot projects, while also looking at other challenges for the future grid. "In 2020, we will focus on flexibility across all work



Sigurd Kvistad; Head of Division Operational Control, Elvia, Chair of the CINELDI Board.

packages. Flexibility can be a valuable alternative or supplement to traditional grid investments. We want to learn more about how flexible resources - that is, dispatchable loads, distributed generation and electrical storage such as batteries - can be utilised to facilitate the Smart Grid transition. In other words, the common priority for 2020 is *flexibility*," Sigurd Kvistad says. Gerd agrees to this sentiment, adding that an increased focus on the current pilot projects and international visibility are also keys for 2020.

"We will emphasise how some of the pilot projects can contribute to the research on flexibility. It's also important for us to continue being visible internationally. Our ambition is to be an international reference project. CINELDI is in a good position for this, since we are one of the largest research centres on Smart Grids. Our research is applicable to many different topics, we have excellent partners and great resources."



CINELDI develops the electricity grid of the future

CINELDI enables a cost-efficient realisation of the future flexible and robust electricity distribution system by developing new concepts, technologies and solutions. By providing new visionary smart grid-solutions and testing them in laboratory and real-life environments, the knowledge and experience gained helps grid companies, the system operator, manufacturers and ICT companies to develop and integrate new technologies and work processes, stimulating innovations. These innovations will in turn contribute to a more sustainable energy system by increasing influx of renewables, electrification of transport and more efficient energy use. To achieve this, the digitalisation of the distribution system is needed.

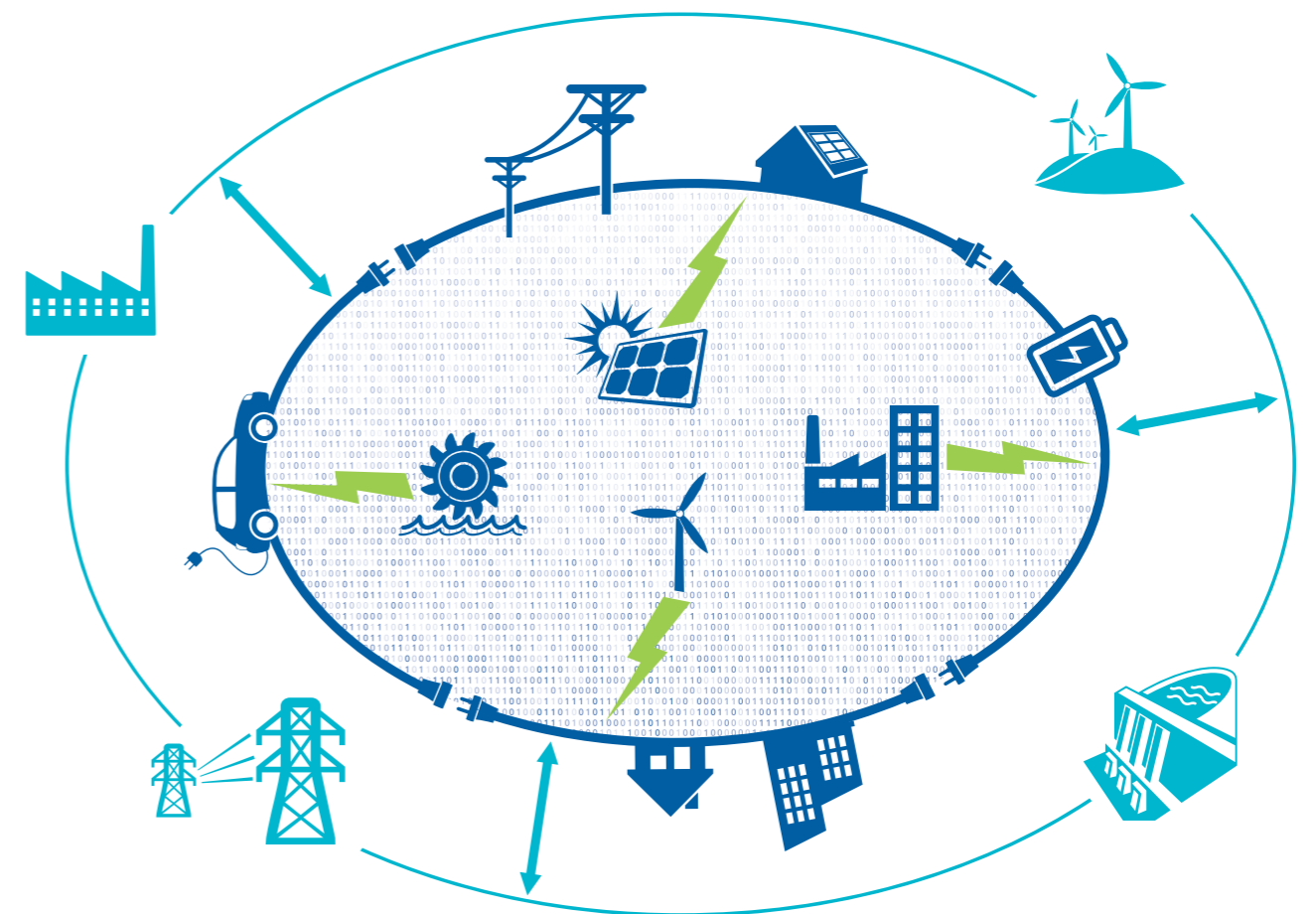

VISION, MISSION AND GOALS



CINELDI VISION

CINELDI develops the electricity grid of the future.



CINELDI MISSION

CINELDI works towards digitalising and modernising the electricity distribution grid for higher efficiency, flexibility and resilience.



GOALS

CINELDI will enable a cost-efficient realisation of the future flexible and robust electricity distribution grid.

By acting as a national hub for long-term research and innovation within intelligent electricity distribution, CINELDI brings together many innovative stakeholders for the development and implementation of new technologies, work processes and solutions to develop the electricity grid of the future.

CINELDI is equipped to tackle the challenge with its unique combination of academic resources, computer modelling and simulation facilities, the Norwegian Smart Grid Laboratory infrastructure, and pilots and demos integrating the involvement from industry partners.

One of the main goals of transforming today's ageing and passive electricity grid into a flexible, intelligent and robust grid for the future, is to lay the foundation for reaching the energy and climate goals related to increasing distributed generation from renewable energy sources, electrification of transport and

efficient energy use. This transformation should be made with acceptable costs, without jeopardising the security of electricity supply which is increasingly important in an even more electrified world.

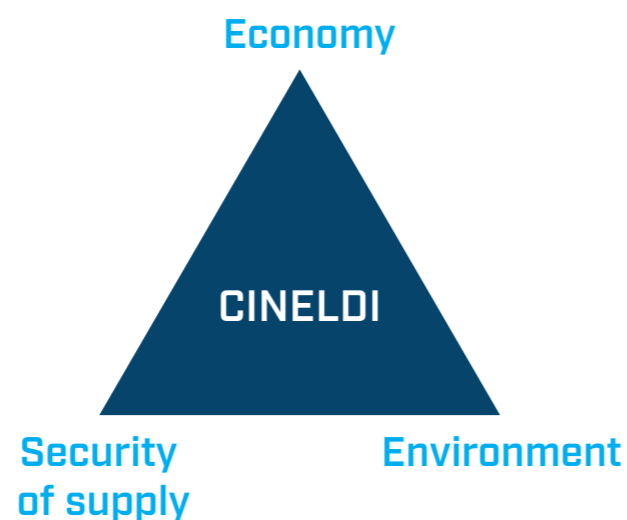

Providing electricity with a high security of supply, which is also affordable, while at the same time ensuring the environmental goals, is often termed the energy trilemma, as these three goals are partly contradicting.

To reach its main goal, CINELDI therefore seeks to balance the three goals related to the electricity distribution grid as explained in the following:

Economy:

CINELDI shall enable a socio-economic, cost-efficient realisation of the future flexible and robust electricity distribution grid and reduce the total distribution system costs compared to the "business as usual"-solutions by reducing operational (OPEX) and investment costs (CAPEX).

Environment:

CINELDI will pave the ground for increased distributed generation from renewable energy sources, electrification of transport and efficient use of electric power and energy.

Security of electricity supply:

CINELDI will ensure the security of electricity supply, comprising the energy availability, power capacity, reliability of supply and voltage quality, as well as the cyber security, safety and privacy – as important parts of developing the electricity grid of the future.

Main deliverables

The main deliverables from CINELDI are:

- Decision support methodologies and tools needed for the optimal planning and asset management of the future system.
- New cost-effective concepts and solutions for smart operations based on new emerging control and monitoring technologies and extensive real time monitoring.
- Methods and models for cost-effective integration of flexible resources in smart distribution grids, including business models on how to utilise this flexibility.
- New concepts and solutions for utilising flexible resources in ancillary services and for increased observability between the distribution and transmission systems.
- Microgrid concepts, technologies and solutions for optimal design, operation, and integration with the distribution system.
- Roadmap and recommendations for the transition to the intelligent electricity distribution system of 2030-2040 in Norway.
- Knowledge base for grid owners and public authorities.
- Training researchers and master students and transfer expertise to industrial stakeholders.
- Efficient knowledge transfer through goal-oriented communication and user-involvement.
- Facilitate business opportunities for technology providers by knowledge transfer.
- Innovation opportunities for DSOs and TSO.



A STRUCTURED
LOOK AT SPECIFIC
SMART GRID
SCENARIOS

The smart grid of tomorrow will be one of the most complex systems ever developed. To better understand this complexity and prepare all relevant parties for the transition to come, CINELDI undertook a successful multidisciplinary foresight process.

Through this systematic review of inputs including megatrends and smart grid driving forces, a set of potential scenarios and mini scenarios were developed that consider the impact on security of supply, economy, cybersecurity and safety for each situation.

A mini scenario is a plausible event, development or action of significance for the future electricity distribution and can be combined in different ways to support or help understand main scenarios. Some mini scenarios have a clear negative or positive impact on the grid performance, whereas the impact of others is more uncertain.

Was it useful? The short answer is yes. More than 50% of CINELDI partners surveyed said they planned to use the results of this work in R&D strategy, company strategy, development of expertise or a strategy for pilots and demonstration projects. Several companies – especially grid operators – have already used the results.

Within CINELDI, the scenarios are now being used as a common base for other research, with the aim of reducing uncertainties in the development of a solid transition strategy towards a smart grid for Norway.

Specific mini scenarios proved valuable for all

The impact of the process surprised the team in several ways. Mini scenarios were expected to be one of the steps in developing the main scenarios, but they proved interesting in their own right for many stakeholders, both researchers and industrial representatives. The complexity of the main scenarios means that the much more specific mini scenarios were welcomed. They are now being used by industry and in other work packages because they highlight concrete examples of unique challenges and considerations.

"It seems now as if the main scenarios will become a tool for communication, to help set the centre's work in context and describe the future grid. It's the mini-scenarios that will provide the substance on which to build further research and transition planning," explains CINELDI Centre Director Gerd Kjølle.

A foresight process involving all actors

The team undertook a multidisciplinary foresight process including the most prominent technology providers in Norway, innovative grid operators, the Norwegian transmission system operator, research institutes, a university, energy authorities and market operators.

Why so many? The foresight process assumes that the future is not pre-determined and can evolve in different directions, which requires analysis from multiple perspectives. The process is therefore designed to capture reality and associated variables

from more than one dimension. Foresight is not just about analysing the future, but also supporting the actors that will shape that future.

Driving forces: understanding the big picture first

Using various inputs, the process followed three steps: analysis and identification of driving forces, interpretation, and prospection. Gerd explains why the process begins with identifying and understanding driving forces:

"The needs of our society in the future will be dictated largely by megatrends and driving forces. A vast range of factors—human, technological, economic, regulatory—will impact the complexity of the smart grid, so we must consider all angles and all possibilities. Some factors drive development, some enable it, and others form barriers."

Once the driving forces were understood including all interconnections during the interpretation step, scenarios and mini scenarios were built to map potential futures in the prospection step. The scenarios are developed around plausible futures.

While the scenarios are now being used by other work packages, the experience of the foresight process will also be an important input to further work. "The transition strategy will integrate results from all CINELDI work packages. This is a complex field because of its multidisciplinary nature, so our positive experience of these foresight workshops is an important input when planning the next steps," says Tonje Skoglund Hermansen, who led the first part of the foresight process.

Selected mini scenarios

Here are just four examples from the more than 100 identified during the foresight process:

Information overload: Cheaper sensor devices lead to more measurement devices in the grid creating data overwhelm. The grid operator is unable to analyse all the data quickly enough leading to incorrect decision-making. This mini scenario would have a negative impact on security of supply, economy, and safety.

From peak power to stable loads: Electrified transport requires fast charging, creating a capacity challenge for the grid. Investments in onshore batteries results in stable load for the grid, and the ability for transport providers to support the grid in high load periods. This mini scenario would have a positive impact on security of supply and the economy.

Specialised competence: Grid operator recruitment is focused on specialised expertise in either ICT or electric power skills, which could result in a lack of interdependency understanding. Good ICT and electric power solutions are developed separately, but not coordinated. This mini scenario would have a negative impact on security of supply and the economy.

More offline microgrids: Distributed generation and neighbourhood microgrids reduce demand at the grid connection point. Several microgrids choose to go offline, which reduces the demand on the distribution grid further. This mini scenario would have an uncertain impact in all four areas: security of supply, economy, cybersecurity and safety.

TESTING A BATTERY THAT FEEDS THE GRID

Electricity distributors *Lyse Elnett* have connected a battery system to provide voltage support to the electricity grid. And so far, it's working very well.

"We can see that the battery is working", says Project Manager Aina R. D. Serigstad, and points to the housing containing four battery modules, three inverters and an intermediate transformer.



“In collaboration with the CINELDI research centre, we are currently conducting tests to see if batteries can be used to support low-voltage grids. It is useful to be able to get input and feedback from and share our experience with researchers and other grid companies”, says Aina R. D. Serigstad, who is a Project Manager at *Lyse Elnett*.

Some distribution grids are currently experiencing problems with voltage quality, and there is every reason to believe that these issues will become even more pressing as the electrification of society progresses.

This is the premise behind *Lyse Elnett*'s pilot project that, among other things, is conducting tests to identify optimum voltage regulation parameters in relation to grid load.

The project will focus on aspects such as response times to voltage variations, power losses and battery system efficiency.

Anxious this winter

The battery system is located in Ims in Sandnes, and was put into operation in August this year.

“We haven't seen very many cost-benefit analyses yet, but we can see that the battery is working”, says Serigstad. “It doesn't have the same speed of response that we're looking for, but it is helping to keep the voltage stable. It is also important for us to see how the system works in full operation, and to monitor its stability and maintenance needs”, she says. Serigstad is anxious to see how the battery will perform during the winter when the load on the grid will be higher.

Detailed measurements

In brief, the battery system is installed in a small 230V overhead grid that supplies low voltage at certain periods. The system is made up of an outdoor battery housing containing four battery modules, three inverters and an intermediate transformer.

The battery can store 19.6 kWh and has an installed capacity of 18 kW. It is connected to the overhead line via a connection box. The box contains an automatic voltmeter that controls the flow of energy in and out of the grid, as well as an Elspec power quality meter.

“This provides us with the detailed measurements that we will use to analyse voltage quality and assess the efficiency of the system. Charging and discharging are regulated by the voltage level in such a way that the battery feeds power into the grid when voltage falls below a predefined level, and is then charged up when the voltage exceeds a predetermined upper threshold”, says Serigstad.

Benefits of batteries

Batteries have been increasing in popularity in recent years. The benefits are that they are mobile and have a multitude of different applications. This means that they can be installed precisely where they are needed. Serigstad believes that many battery systems will be installed in the grid in the years to come.

“We're only looking into voltage support services as part of our project”, she says. “But the increase in electric vehicles on our roads will provide new opportunities because they can function as battery packs – feeding energy into the grid when they are parked, and charging up when demand is less great.

It is likely that we will be seeing more of this in the future”, says Serigstad.

“But is it currently profitable to install batteries to provide voltage support today?”

“We could improve voltage quality in our project much more cheaply”, she says. “The battery itself forms only part of the cost. Additional costs are linked to such aspects as adaptation of the grid, finding a suitable location to install the system and entering into contracts with landowners.



The system consists of an outdoor battery housing that provides voltage support to a small 230V overhead grid that supplies low voltage at certain periods.

THE BIG “LIVING” ENERGY LAB

At the energy laboratory *Skagerak Energilab*, scientists from the CINELDI research centre are now able to carry out full-scale tests of microgrids together with *Skagerak Nett*. The stadium of Odd football club in Skien has 4,300 square metres of solar panels mounted on its roof, and an 800 kW battery installed by the entrance.



Skagerak Energilab





When the battery is fully charged it has sufficient capacity to provide floodlighting for the stadium for the two hours it takes to complete a football match. The system also serves as a back-up source of electricity for households in the neighbourhood, and some electricity can be fed into the distribution grid.

“These homes and business premises are all incorporated in a microgrid”, says Signe Marie Oland at the grid company *Skagerak Nett AS*. Advanced equipment in the form of a distributed generator enables “islanding” in situations where there is an outage of the main grid”, she says.

Oland is also Project Manager at the energy laboratory and test facility *Skagerak Energilab*, which is owned by *Skagerak Nett*, one of the partners in the CINELDI research centre. When Oland showed the online energy technology magazine *Energiteknikk* around the facility on a dark and rainy day in November, production from the solar panels was running at rather low levels. However, over an entire year, the aim is for them to produce 660 MWh of electricity, enough to supply 35 homes.

Skagerak Energilab was officially opened this summer, while test plans and laboratory details were finalised in the autumn. The battery, the distributed generator with its air-insulated switchgear, and other electrotechnical equipment has been supplied by ABB, while the solar panels were delivered by FUSen.

Exciting variables

“*Skagerak Energilab* is providing us with an opportunity to find out how local solar power generation, combined with battery storage, can interact with the existing

distribution grid”, says Oland. “There are many exciting variables linked to electricity consumption and grid management that the lab can test at full scale”, she says.

She goes on to add that *Skagerak Nett* obtains a lot of information that it can use from new AMS smart meters. Such information enables the company to predict how the battery should be charged and discharged during the day in order to boost the quality of electricity supplies to consumers. The equipment in the lab will make it easier to manage these huge data volumes.

Focus on R&D

“Like all electricity providers we will be facing major challenges in the years ahead, not least electrification, and we have to start finding some smart solutions”, says Oland. “*Skagerak Nett* is devoting a lot of attention to its R&D activities, and this is why we have invested in this unique facility”, she says.

The energy laboratory is full of advanced equipment that both *Skagerak*’s own scientists and visiting researchers will be able to use to carry out tests such as how the islanding of microgrids impacts on voltage quality and frequency.

Analysing consumption

“For example, we can carry out a number of different calculations and simulations, such as of production levels from the solar panels and the levels of consumption of customers on the following day. Then we can determine whether any surplus power should be stored in the battery or sold on the open market”,

says Oland. “We are also able to analyse how capacity is used, and we can see what happens if peak load is spread out over a greater part of any given day.

An important goal for us is to achieve stable and efficient grid operation. We want to reduce wear and tear and maintenance and to look in more detail at how we can use the battery to carry out preventive work in relation to the grid. The battery has a number of functions that can make a contribution towards efficient operation of the grid, and we will be running tests on these”, she says.

Simulation of operation in island mode

Oland adds that it will be interesting to start running simulations of microgrid operation in island mode (islanding). “We have defined a number of microgrid “use cases” that we want to implement”, she says. “These may include looking into the impacts and opportunities linked to electric vehicle (EV) charging, as well as issues related to prosumers”, says Oland. She points out that a rapid charging station for EVs has been installed outside the stadium entrance.

Skagerak Energilab as a whole has cost NOK 30 million. Almost half of this has been paid for by a grant from the green energy funding organisation Enova, and these funds have made it possible for *Skagerak* to complete the project.

A wild idea

It all started as a wild idea in the head of the Odd football club Chief Administrator Einar Håndløyken. He has spent many years as an environmentalist, including a period as leader of the Norwegian Zero Emissions

Resource Organisation (*Miljøstiftelsen Zero*). Under Håndløyken, Odd has stated its clear ambition to become Norway’s most eco-friendly football club.

The plans for the *Skagerak Arena* were put in motion, and Håndløyken was convinced that the extensive roof construction could be used for something useful such as the generation of eco-friendly energy. So he got in touch with *Skagerak Energi*, a long-standing business partner of the club, and the snowball started to roll. The outcome is the *Skagerak Energilab*.

Distinguished visit from China

This unique facility has also drawn a lot of attention from overseas. Just recently the laboratory was visited by the head of the Chinese State Grid Corporation (SGCC), one of the biggest energy companies in China, who was very excited about what he saw.

“We’re very proud of the completion of the *Skagerak Energilab*”, says Signe Marie Oland at *Skagerak Nett*. “It shows that we are an energy company with a progressive mindset and that we take our social responsibility for the sustainable development of the electricity grid seriously”, she says.

RESEARCH AND INNOVATION STRATEGY

Research

The research in CINELDI targets the electricity grid situation in 2030-2040, 10-20 years after the deployment of Norway's first-generation smart meters (AMI) in 2019.

The research activities are designed to meet the main goal of CINELDI in close cooperation between the technologies power engineering, cybernetics, information and communication technology, supported by social sciences (socio-economics and consumer behaviour related to flexibility).

The research activities are organised in six research areas, represented by the work packages (WP). In addition to the six research areas, there is a work package on coordination of pilot projects:

- Smart grid development and asset management (WP1)
- Smart grid operation (WP2)
- Interaction DSO/TSO (WP3)
- Microgrids (WP4)
- Flexible resources in the power system (WP5)
- Smart grid scenarios and transition strategies (WP6)
- Pilot project coordination (WP Pilot)

WP1-6 reflect the main aspects of power system operation and management and are tightly integrated to stimulate innovative ability at the electricity distribution level. This ensures that each WP addresses research questions of high relevance for industry and society, enable academic partners to work in close collaboration regardless of discipline and facilitate interaction and communication between research and industry partners.

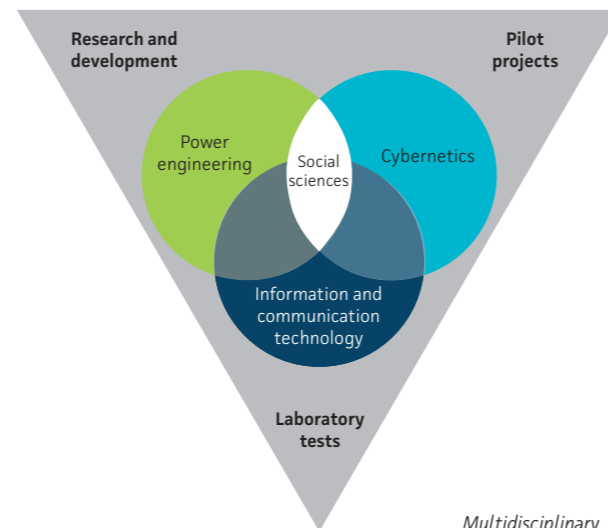

Multidisciplinary research platform

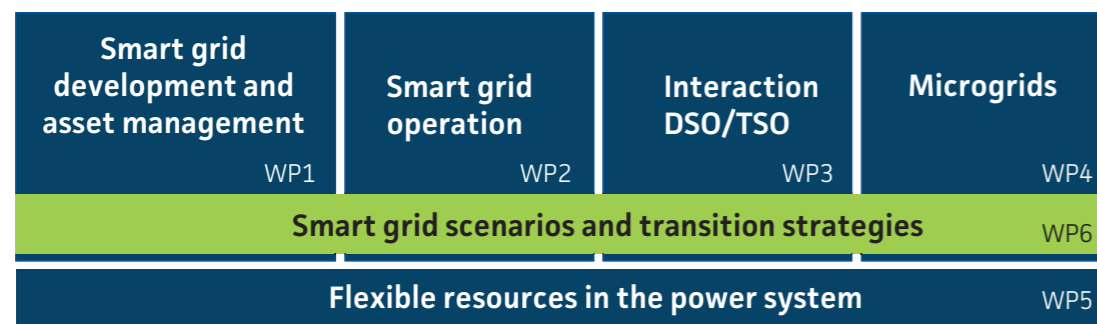

CINELDI WPs and how they are organised

The CINELDI multidisciplinary research platform consists of three pillars:

- Research and development
- Pilot projects
- Laboratory tests.

Advanced basic and applied research will provide in-depth knowledge, methods, and tools that will be tested in laboratories, simulated environments and small-scale field pilots.

Active utilisation of use case methodology and research infrastructure including the Norwegian Smart Grid laboratory and living labs in pilot projects and laboratory tests are important parts of the research strategy and the multidisciplinary research platform, integrating active involvement from the industry partners.

Innovation

Innovation is a key factor to succeed with CINELDI and the Centre targets system innovation for the electricity distribution system.

CINELDI is positioned between targeted basic research and Demonstration (TRL 5-9) and novel technology & business opportunities.

Through working with user partners, CINELDI will identify new business opportunities and elevate pilot projects to new national and international spin-off projects along the whole value chain, in particular build-up capacity to succeed in H2020 projects with higher TRL levels (5-9).

One example of a CINELDI innovation is the TRL 9 innovation EV Power Share Charging System.

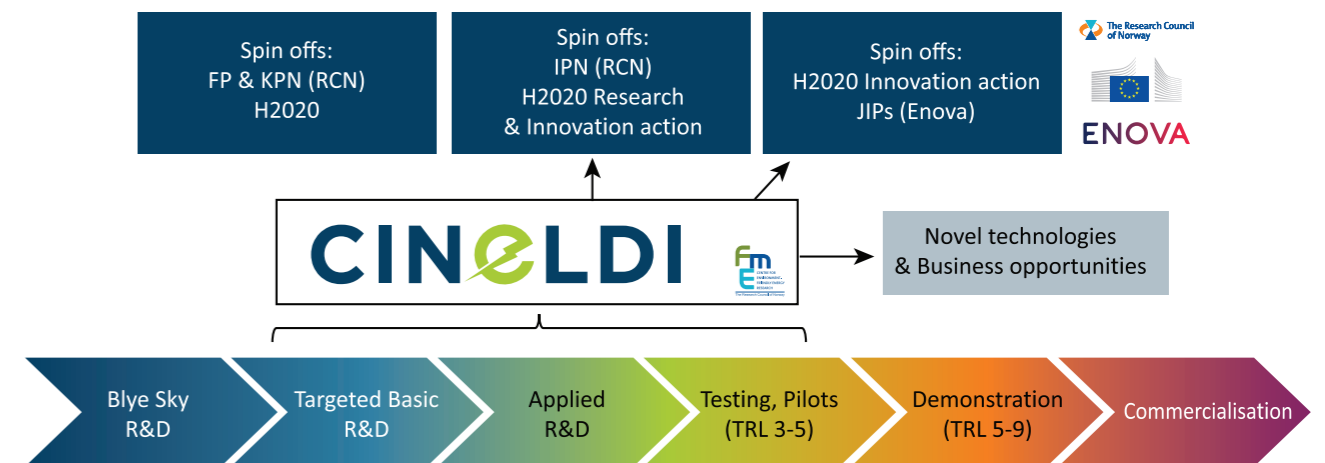

CINELDI innovations and Spin Offs

EV POWER SHARE CHARGING SYSTEM

Developed within CINELDI, the EV Power Share Charging System (Power Share) is a new product from NTE and ENOCO AS, developed within CINELDI.

Power Share is a building integrated charging system for electric vehicles (EVs), where a large number of EVs within an area can be charged at the same time. The system has a control unit logging use/power and communicating with an Energy Management System (EMS) or a Building Energy Management System (BEMS).

The challenge and solution

Charging of EVs within a limited geographical area can give high peaks both in the area and in the power grid. There might also be constraints related to the actual electric circuit, the main fuse or the capacity in a transformer nearby.

A system where power is shared enables dynamic regulation of the power used for charging. The regulation is based on the market value for the specific circuit or dynamically based on input signals regulating the peak load of all EVs in total. The system is installed at Risvollan Housing cooperative, where 768 charging points for EVs are planned in parking garages and parking lots.

Potentials

The 768 charging points represents 5 MW peak power consumption. With the Power Share solution, the peak load can be controlled statically or dynamically. Statically by defining a fixed peak load. Dynamically based on other types of electricity consumption connected to the same electric circuit, data from smart transformers or based on grid related needs, based on the published ACOPF algorithms: «The proposed multi-period acopf methodology».



ORGANISATION

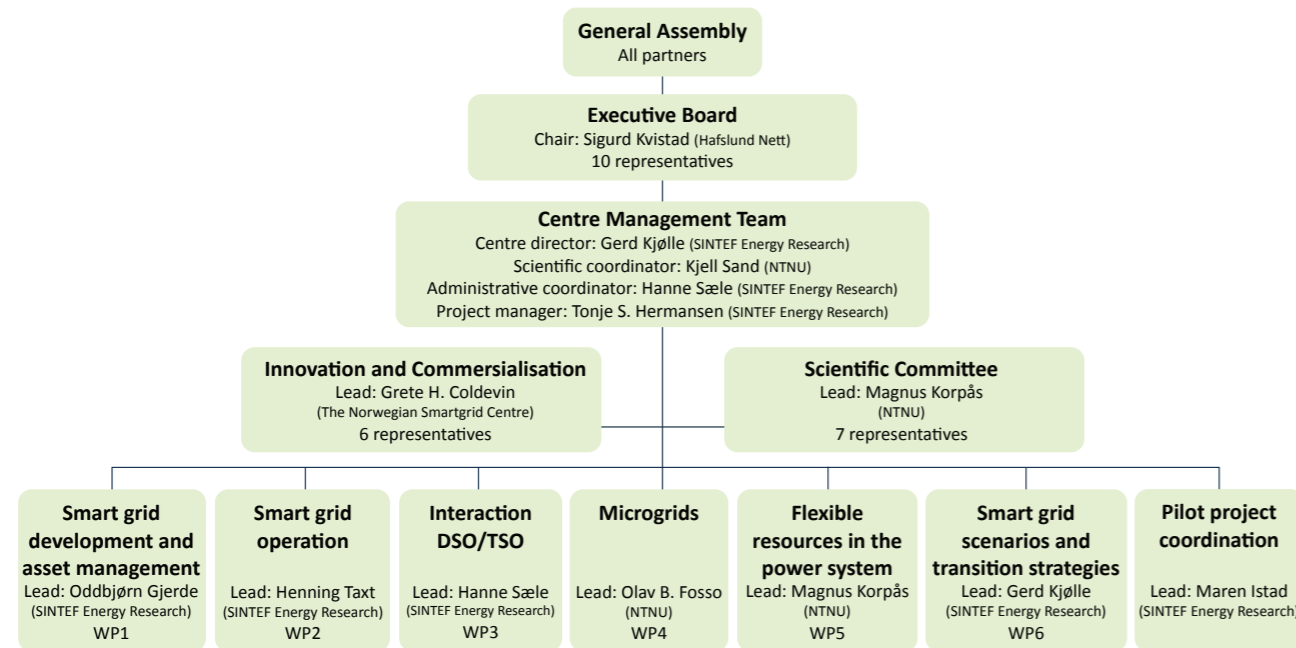

Outline of governance structure for CINELDI per 2019

Partners

Research partners



SINTEF Energy Research



NTNU - Norwegian University of Science and Technology



SINTEF Digital

Power Grid Companies



Agder Energi



BKK



Eidsiva Nett AS



Hafslund Nett AS



Haugaland Kraft Nett



Helgeland Kraft



Istad Nett AS



Lyse Elnett AS



Nordlandsnett AS



Norgesnett



SFE Nett AS



Skagerak Nett AS



Tensio

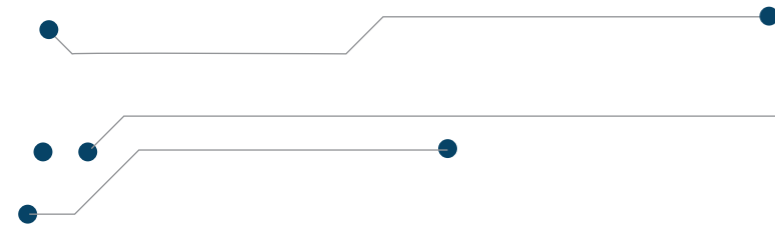

System Operators

Statnett

Statnett

Power market operators

NORD POOL

Nord Pool

Technology Providers



ABB AS



Aidon



Disruptive Technologies



Rejlers



Smartgrid Services Cluster



Powel

Member Organizations



Energy Norway



KraftCERT



The Norwegian Smart Grid Centre

Authorities



Directorate for Civil Protection and Emergency Planning (DSB)



The Norwegian Water Resources and Energy Directorate (NVE)



Norwegian Communications Authority

Cooperation between partners

CINELDI had a total of 30 partners in 2019, including 27 user partners. In 2019, partners have participated in several workshops, to discuss activities and contribute to the research in CINELDI.

In April, the first CINELDI conference was arranged, followed by an internal partner day. On the conference, research results from CINELDI were presented. On the internal partner day, one of the sessions were dedicated to WP6, where the partners were actively involved in group work on developing scenarios for the future distribution grid.

In June, WP1 and WP2 arranged workshops for the partners. The two topics for the WP1 workshop were *active distribution system planning* and *digital inspection*, and the workshop included presentations from the researchers and the user partners as well as group work. The topic for the WP2 workshop was *use cases (and mis-use cases) for future smart distribution grid operation*. Several use cases were discussed with the partners, and the feedback was used in further development of the use cases. In October, WP3 and WP5 arranged a common workshop on flexibility. Research results were presented, and possible pilot projects were discussed.

In November, more than 60 persons from the consortium were gathered for the annual CINELDI days. The purposes of the days were to present examples from the research, to discuss the development of transition strategies, and to present and discuss pilot projects in CINELDI. Skagerak Nett and Eivind Gramme were awarded the second CINELDI prize for their engagement in the centre.

In 2019, 21 webinars have been held for the partners in CINELDI. Through the webinars, the partners have got frequent updates on the research activities and have also had the opportunity to ask questions and discuss preliminary results. Several of the PhDs have also presented their work in webinars.

All WPs have actively used the expert groups in the development of the work plans for the coming year(s). The expert groups have also been involved in planning partner workshops.

In all WPs, there is cooperation between the R&D partners, as all work packages are multidisciplinary organised. The user partners are involved in several case studies as part of the research activities.

Pilot projects are also an arena for cooperation between the different R&D partners and user partners, see section on "Pilot projects in CINELDI".

RESEARCH ACTIVITIES AND RESULTS

The research in CINELDI addresses advances of electricity distribution system planning, operations and management, where new and emerging topics are emphasised. A few examples are utilisation of innovative sensors and smart components for monitoring and control, microgrids and utilisation of the flexible resources inherent in distributed generation, consumption and electricity storage, and cyber security. The centre has also developed scenarios for the future intelligent distribution grids in Norway.

The Norwegian Smart Grid Laboratory is utilised in several activities already, both in master and PhD-projects as well as by other tasks and researchers. So far, CINELDI has nine PhD students and two Postdoctoral researchers integrated in the work packages, as well as many master projects.

Research highlights from 2019 are presented in the following.

SMART GRID DEVELOPMENT AND ASSET MANAGEMENT (WP1)

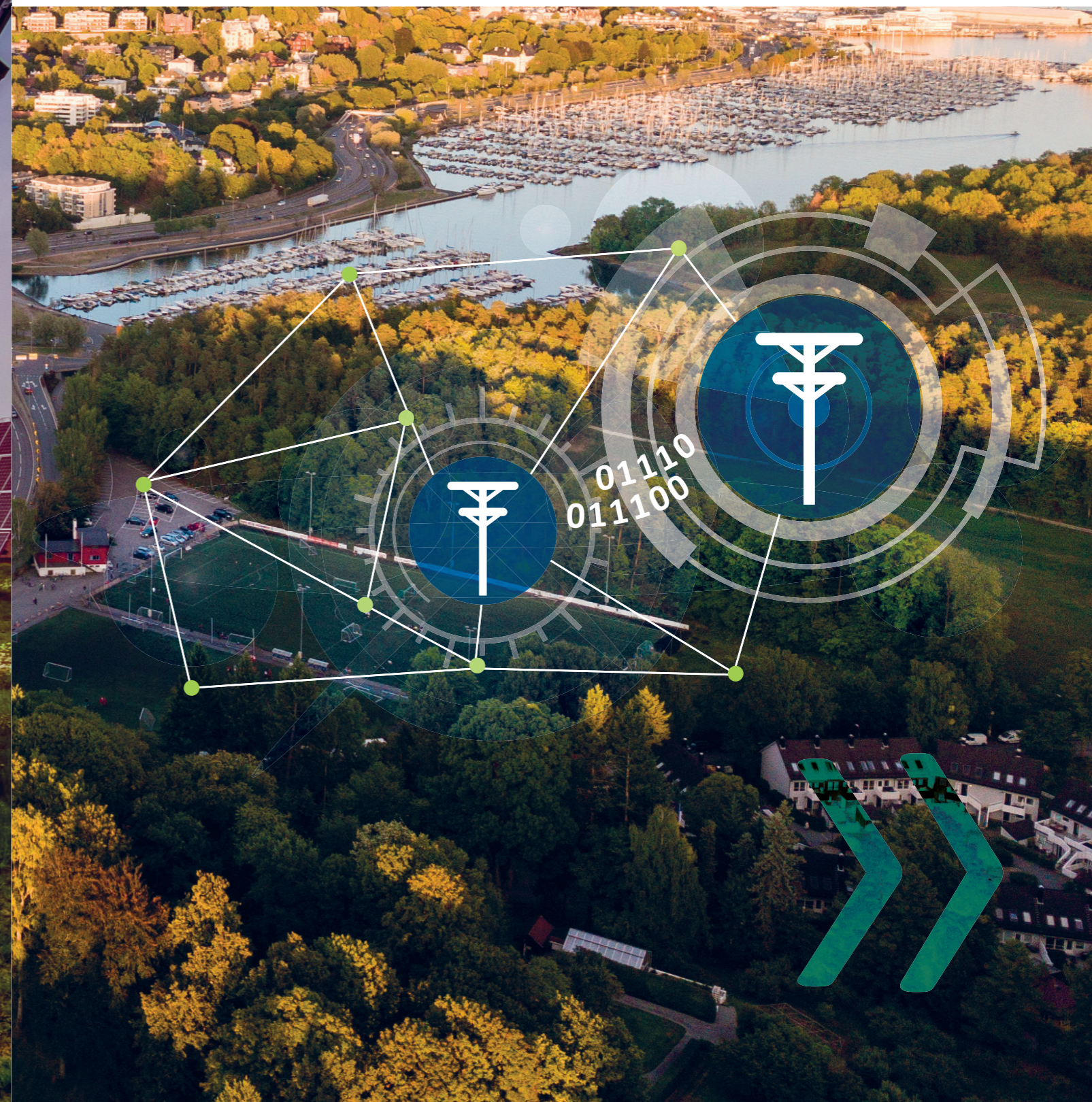

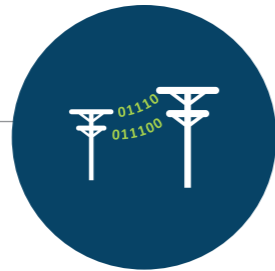

Our primary objective is to develop decision support methodologies and tools needed for optimal planning and asset management of the future robust, flexible and intelligent distribution system.

The expected impact is a more efficient grid through better utilization of existing and new infrastructure, more target-oriented investments, and better control of risks.

In 2019, a first version of a framework for smart grid development was established, taking the above-mentioned aspects into account. It combines the new elements from active distribution grid planning into a framework that the utilities are familiar with and that is adapted to Norwegian conditions.

Active distribution grid planning

The future distribution system will be penetrated by new technologies such as distributed generation, including prosumers and more power intensive loads, resulting in new load and generation patterns. At the same time new sensors and the introduction of IoT and new communication systems are expected to make massive amounts of operational data available.

Many of the changes will be customer driven, and new uncertainties will emerge for the distribution system operators, making planning of "future proof" distribution systems more challenging. These changes will simultaneously offer new possibilities. Examples of new planning options are electrical energy storage, microgrids, demand response schemes and vehicle to grid.

In an active distribution grid, the grid planning will rely on measures taken during system operation to a much larger extent than before. The fact that utilities need to deal with an ageing grid exposed to continuously increasing weather and climate related stresses may also speed up the transition.

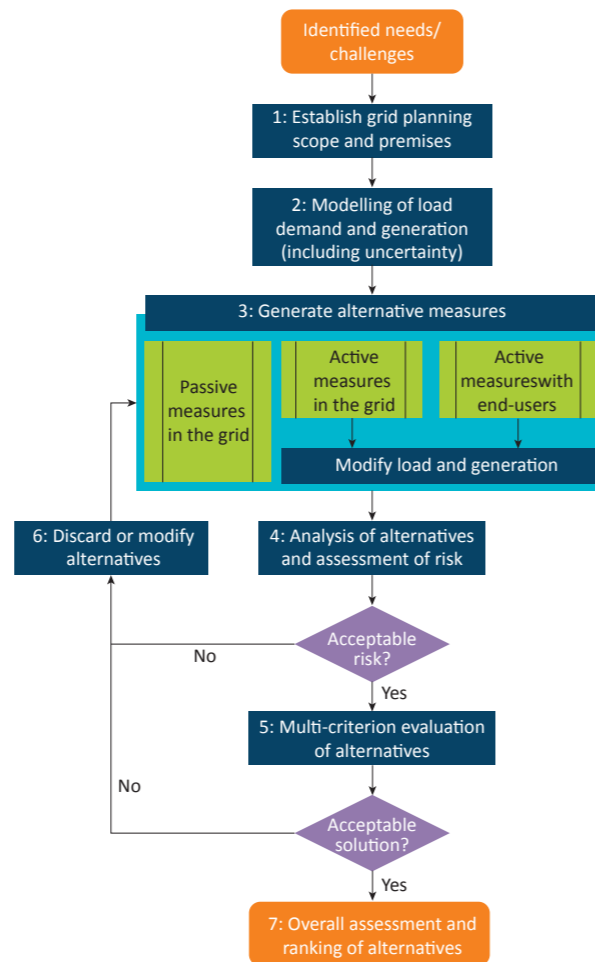

In 2020, the framework will be tested on a realistic distribution grid with distributed PV generation, to explore and compare the cost-benefit of different options involving traditional grid reinforcement, battery energy storage and PV generation flexibility. The results will be described in a conference paper to be submitted for the conference PMAPS 2020.

Changing risk picture due to digitalization - combined power and ICT system reliability

The combination of information and communications technologies (ICT) into the power grid enables new active functions and possibilities through enhanced

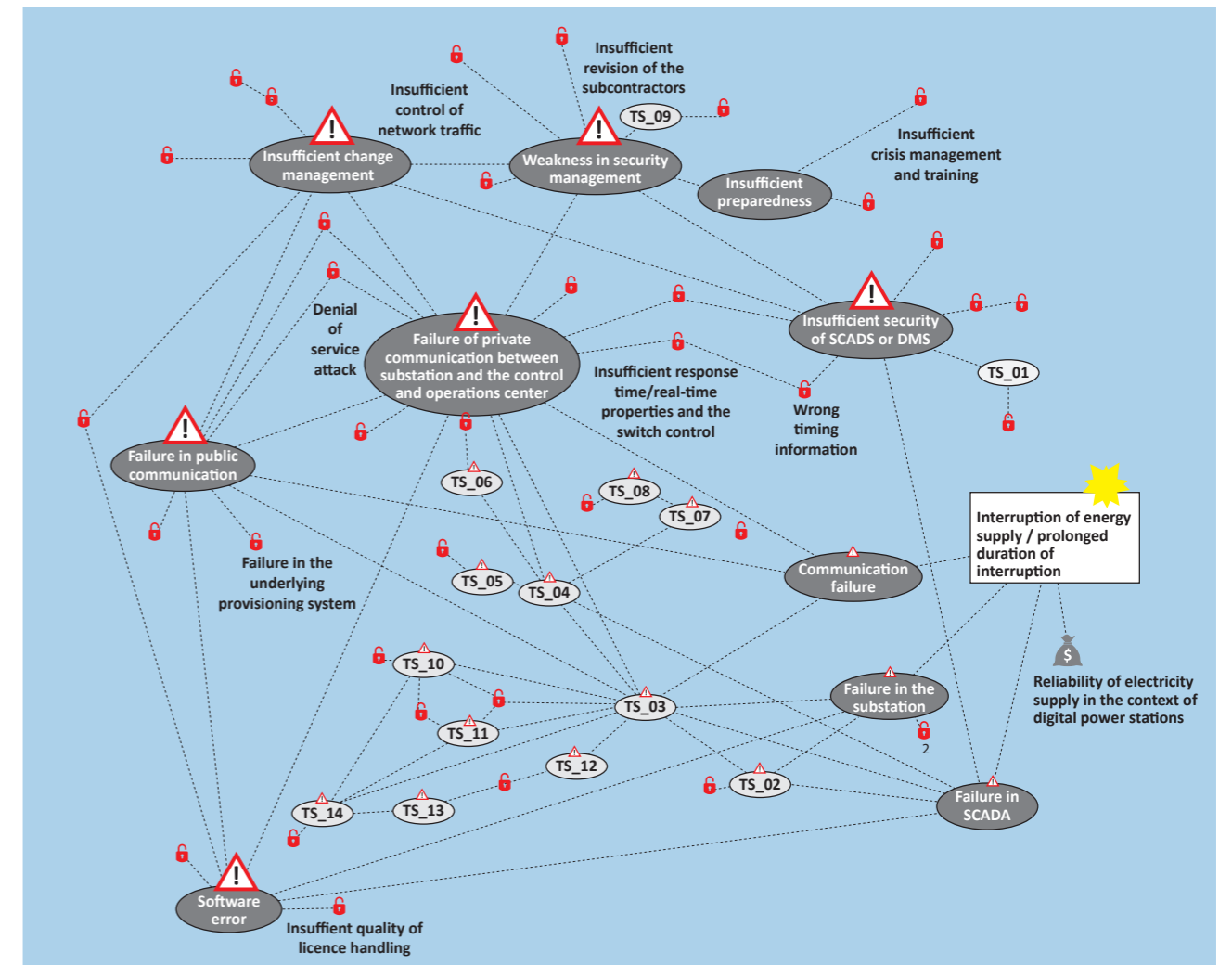

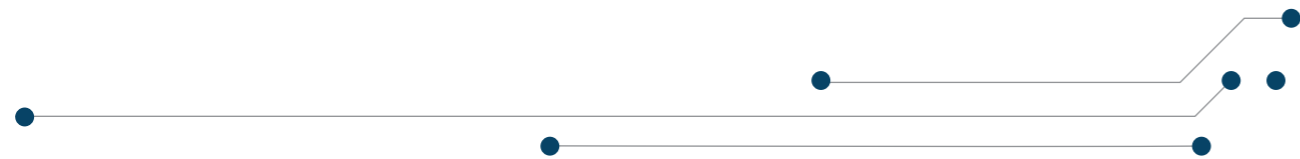

monitoring and control. Simultaneously new threats and vulnerabilities are introduced, related to both cyber security and the increased complexity and interdependencies.

Digital transformation of the power grids has significantly changed the risk picture. Smart grids are characterized by high complexity, uncertainty, dynamics, and interdisciplinarity. An approach to identification and modelling of cybersecurity risks has been proposed earlier, and to gain further experience an industrial evaluation has been carried out as a comprehensive case study together with Lyse Elnett as one of the main activities in WP1 in 2019.

A full-scale performance evaluation of an approach for identification and modelling of cybersecurity risks in the context of digital secondary substations was done. This led to improved understanding of the effects of power grid digitalization on cybersecurity, as well as impacts of cybersecurity on reliability of supply. The results indicate that the proposed approach enabled through domain-customized risk management, provides valuable decision support for management of reliability of power supply and cybersecurity. The figure indicates the complexity and size of the final model, including some of the contents. Selected parts of the model (i.e. those model elements that miss a textual annotation) are, for confidentiality reasons, undisclosed. The disclosed details on the figure include a representative selection of the specific vulnerabilities, threat scenarios, the one unwanted incident and the asset, in order to illustrate the abstraction level and the relationships among the elements.

Remote digital inspection

The future ICT and communication systems will at the one hand be an important provider of asset condition data and on the other hand represent a new asset to be managed optimally in combination with the power system. As an example, in today's regime all distribution system substations are physically inspected once a year. We are aiming to make inspections more efficient by extending the inspection interval through utilising the information from existing and new sensors. This can save inspection costs at the same time as safety and security of supply is maintained or even increased by remote, digital inspection. Events can be alerted when they occur and sensors that detect technical condition can show how the condition changes over time.

The potential for remote, digital sensor-based inspection of medium voltage to low voltage substations, including benefits and challenges, are described based on results from WP1 workshops, preliminary results from pilot projects and literature studies. This includes a high-level use case (draft) of digital sensor-based substation inspection. Compared to manual inspections, the potential is great in terms of time savings, quick notification of unwanted events and registration of technical condition for maintenance purposes.

SMART GRID OPERATION (WP2)



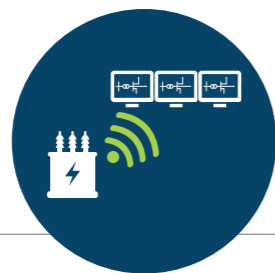

Our objective is to develop and test a set of new concepts and solutions that optimally utilise new emerging control and monitoring technologies capable of exploiting extensive, real time monitoring to/from all assets and network customers and flexible resources.

We expect our work to result in a more flexible operation of the distribution grid, contributing to cost reductions, enhanced energy efficiency, improved system reliability and security, as well as standardised solutions.

Emerging concepts for grid operation

The distribution grid operation is today mainly passive or reactive, meaning that it's not necessary to take much action in the normal operation of the grid. Operations are only performed as a response to some external event or request, such as faults or line disconnections due to maintenance work. It is not yet clear how an active form of distribution grid operation with continuous monitoring and optimized control actions will develop. Its development is increasingly intertwined with the development of the information and communication technology (ICT)-infrastructure.

A set of new concepts in smart grid operation was developed in 2019. An example is a novel concept that utilizes easy-to-connect easy-to-move batteries in the distribution grid, to temporarily mitigate bottlenecks or voltage quality issues. Having this option available could bring value by mitigating the risk associated

with grid investment decisions. By reducing the consequences of underinvestment, less safety margin is required in grid investment decisions, and that could positively affect both the timing and size of the investment needed.

Including ICT in the evaluation and validation of emerging smart grid operations

Smart grid is a system of systems, where the electrical system and the communication and control systems are intertwined. Evaluation and validation of such complex systems require new methods. In CINELDI we are exploring different approaches. One is a joint modelling of the ICT and electrical systems and the other is the testing in a real-time hardware-in-the-loop approach.

The joint model can be used to quantify the reliability of smart grid operations and compare different architectures, such as centralized vs decentralized control. This comparison will allow for more informed investment decisions from the utilities, that will in turn contribute to a more reliable and efficient grid development. The system testing in real-time hardware-in-the-loop, on the other hand, is suitable for assessing the usability and performance of specific equipment, algorithms or communication links. This assessment will give valuable feedback to technology providers and reduce the risk of the utilities when implementing new technology in their operations.

INTERACTION DSO/TSO (WP3)





In WP3 we are developing concepts and solutions for utilizing flexible resources (Distributed Energy Resources) in different market products and ancillary services, for increased observability between the distribution and transmission systems and business models regarding utilisation of customer flexibility (Distributed Energy Resources).

By the end of our work we expect to have improved the interaction between DSOs and TSOs to benefit the total power system, especially by enabling DER flexibility to all voltage levels.

Use cases for application of flexible resources in future ancillary services

We investigate needs, gaps and opportunities related to utilizing flexible resources in different market and ancillary services on transmission level, including services delivered on the interface DSO/TSO. Utilization of flexible resources should be made possible in a coordinated way between DSOs and TSOs regarding e.g. purpose and consequence. In fact, there might be flexible resources planned to be used in ancillary services on the transmission level, that also can be utilized on the distribution level. For example when regulation of distributed generation (DG) in the distribution grid is necessary due to bottlenecks. This interface will be further elaborated.

"Ancillary services" (AS) are services necessary for the operation of a transmission or distribution system, and they can be clustered into frequency ancillary services (balancing of the system) and non-frequency ancillary services (voltage control and black-start capability). Potential future ancillary services were evaluated based on CINELDI mini scenarios. They are basis for

development of use cases describing how different flexibility resources can be utilized in different ancillary services. The main focus was on ancillary services for frequency control (e.g. fast frequency reserves), voltage control (e.g. primary, secondary and tertiary voltage control) and services such as for example black start capability. The main focus is on the ancillary services voltage regulation, management of bottlenecks in the distribution or transmission grid, including in balancing market.

The use cases that are under development will give a broader overview of how different flexible resources can be utilised in different ancillary services. Combining this with CINELDI mini scenarios will give input to the direction of the research within WP3, and knowledge related to when utilizing flexibility can be a new solution.

Algorithms for observability in TSO/DSO interface

Dynamic state estimation of power networks has absorbed increasing attention since the distributed generation and Phasor Measurement Units (PMUs) and other types of fast sensors have been increasingly used in modern power systems. The application of the simultaneous input and state estimation algorithm to the problem has been studied. The proposed algorithm performs dynamic state estimation in a power grid using the partially known network concept in which the unmodeled disturbance signals can be estimated through smoothing. Even though the classic Kalman filtering methods have achieved satisfactory results for state estimation of a power grid, they require strong assumptions such as all parts of the system, including disturbance models, which must be known,

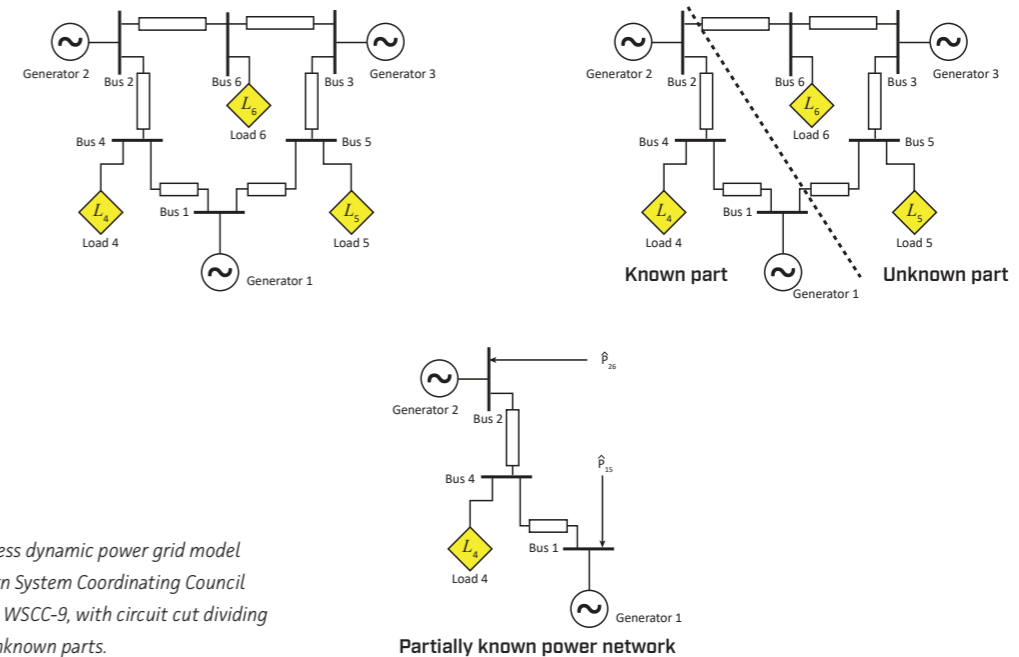

Transformerless dynamic power grid model of the Western System Coordinating Council 9-Bus System, WSCC-9, with circuit cut dividing known and unknown parts.

and it is problematic primarily for the distribution part of power grids. Thus, a power network has been modeled as a system with known and unknown parts. The derivation of the state estimation is based on the model of the known part of the system such that the unknown connected signals are captured using the simultaneous input and state estimation (SISE). The physical nature of power grids admits the application of this estimation approach more widely than is suggested by the disturbance reconstruction condition.

The focus has been narrowed to linearized power systems, and the term "known" has been used to describe a subsystem whose dynamic model is available. In a power grid such as that depicted in the figure above, a virtual circuit cut can be performed to divide the grid into two parts, the left side is known,

and the right side is unknown. The interacting power signals between the known and unknown parts are treated as disturbances flowing into the known part of the system.

During this work, the fast dynamic states and transients of a power network are captured using dynamic procedures, the number of measurements needed for state estimation was reduced significantly, and all available measurements are used at the same time. The unknown parts of a power grid are estimated very accurately without having any information or data from there.

The work was published in both a paper presented at the IEEE Conference on Control Technology and Applications (Aug 2019) and in the Journal Automatica (2019).

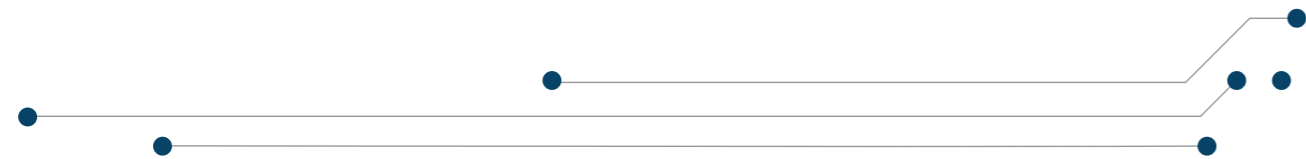

Market architecture for TSO-DSO interaction in the context of European regulation

The growing need for ancillary services due to the variability and uncertainty of distributed generation based on renewable energy sources requires implementation of coordinated market schemes allowing procurement of flexible resources from the distribution grid for ancillary services in both distribution and transmission networks.

Five coordination schemes for TSO-DSO interaction, necessary for procurement and activation of ancillary services were developed and comparatively evaluated. Each of the coordination schemes (CSs) present a different way of organizing the coordination between transmission and distribution system operators (TSOs and DSOs), when distributed resources (production, storage or demand) are used for ancillary services. Each coordination scheme is characterized by a specific set of roles and responsibilities, taken up by system operators and a detailed market design.

The different coordination schemes all have specific benefits and attention points related to operation of the TSO and DSO grids, other market participants involved and the market operation in general. The feasibility of the implementation of each coordination scheme is very dependent upon the regulatory framework.

The characteristics of the different coordination schemes are:

- 1 Centralized AS market model - The TSO operates a market for both resources connected at transmission and distribution level, without extensive involvement of the DSO.

- 2 Local AS market model - The DSO organizes a local market for resources connected to the DSO-grid and, after solving local grid constraints, aggregates and offers the remaining bids to the TSO.
- 3 Shared balancing Responsibility Model - Balancing responsibilities are exercised separately by TSO and DSO, each on its own network. The DSO organizes a local market while respecting an exchange power schedule agreed with the TSO, while the TSO has no access to the resources connected to the distribution grid.
- 4 Common TSO-DSO AS Market Model: The TSO and the DSO have a common objective to decrease the cost of the resources they need, and this common objective could be realized by the joint operation of a common market (centralized variant), or the dynamic integration of a local market, operated by the DSO, and a central market, operated by the TSO (decentralized variant).
- 5 Integrated Flexibility Market Model: The market is open for both regulated (TSOs, DSOs) and non-regulated market parties, which requires the introduction of an independent market operator to guarantee neutrality.

The implementation of a coordination scheme is influenced by the national organization of TSOs and DSOs, e.g. the number of system operators (both TSOs and DSOs) and the way they currently interact. Although TSO-DSO coordination could be organized on a country level, it is important to integrate national TSO-DSO coordination set-ups within the process of EU harmonization and integration.

The work is performed in cooperation with H2020 project SmartNet.

MICROGRIDS (WP4)

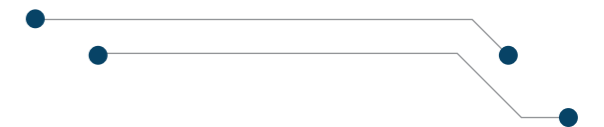

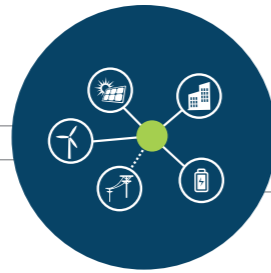

In WP4, our objective is to develop concepts, technologies and models for microgrids and their interaction with the distribution system.

We expect our work to contribute to a cost-efficient and robust integration of microgrids with the distribution grid, and a contribution and to the integration of more distributed and renewable energy resources (DER) in the system.

In short, microgrids are groups of interconnected components that can act as a single controllable entity with respect to the grid. They may be connected to the grid or operated in isolation, although in most cases in Norway they will be connected to the grid. Microgrids can be viewed as a bottom-up approach for implementing a smart and flexible distribution grid.

Power Hardware-in-the-Loop (PHIL) for Microgrid Performance Analysis

Microgrids are complex systems consisting of components and controllers dynamically interacting in a wide range of time constants. A proper assessment of the performance of this interaction is crucial for a secure operation of the microgrid. Particularly for systems which may operate in isolated mode, it is important to assess how the components interact when limited inertia is present. For testing of such performance there are essentially four approaches:

1. *Full-scale microgrids*: This is the most expensive way to test a microgrid. It provides the highest fidelity but has the limitation that normal operating conditions are tested in a full-scale microgrid.

2. *Prototypes*: A scaled down version of the full-scale microgrid. It is a cheaper option compared with the full-scale but still expensive. It provides good fidelity, but it has almost the same limitation regarding the test coverage.
3. *Simulation*: This is the most cost-effective solution for testing any physical system, microgrids included. It has the advantage of unlimited range for testing i.e. high-test coverage. Normally, it is the first step for testing any new microgrids. However, the fidelity depends on the assumptions made in the simulation models.
4. *Controller Hardware-in the loop (HIL) and Power Hardware-in the loop (PHIL)*: This is a hybrid between hardware and simulation. HIL takes the flexibility of the simulations, so it has a greater range of test coverage compared with pure hardware setups. As well, HIL takes the fidelity over the hardware that is under test.

In the National Smartgrid laboratory, it is decided to go for a flexible approach at an intermediate cost level and therefore chose the *Power Hardware-in-the-Loop (PHIL) concept*. A goal within CINELDI, has been to develop a Real-time Power Hardware-in-the-loop microgrid simulation platform that can accelerate the deployment of new microgrids into the Norwegian distribution system.

As a base case, it was decided to simulate an internationally recognized benchmark low voltage microgrid network. This is an implementation where one or two converters exchange power with a simulated distribution grid following the PHIL approach. The PHIL uses a real-time simulator to generate the simulation environment that is compatible with real hardware, in this case a power

converter. The Real-time simulator interacts with a power amplifier to exchange energy with the hardware under test. This diagram (right) visualises the process, while the image below shows the schematic and physical implementation. The simulation environment is provided with a user-interface as illustrated in the figure on page 50.

Simulation studies proved both the feasibility of the model and the facilities in the National SmartGrid laboratory to simulate microgrid models using the PHIL approach. There is great potential in applying this technique to microgrid research and development since it can be applied to a wide range of system models with a flexibility in designing test scenarios. For the further work, a more sophisticated energy management system will be developed to demonstrate the potential in a more complex microgrid.

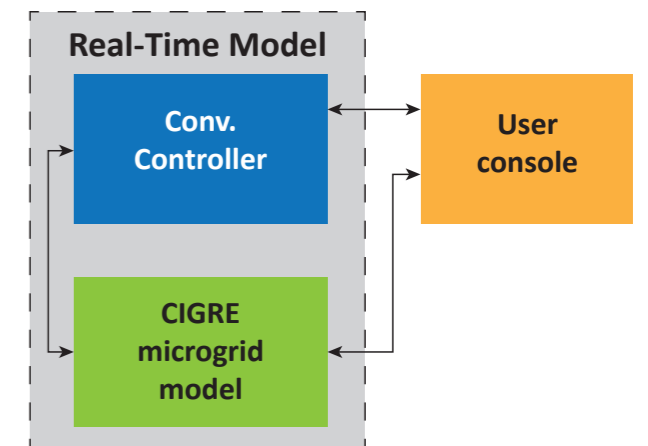

Generic structure in Real-Time simulation environment

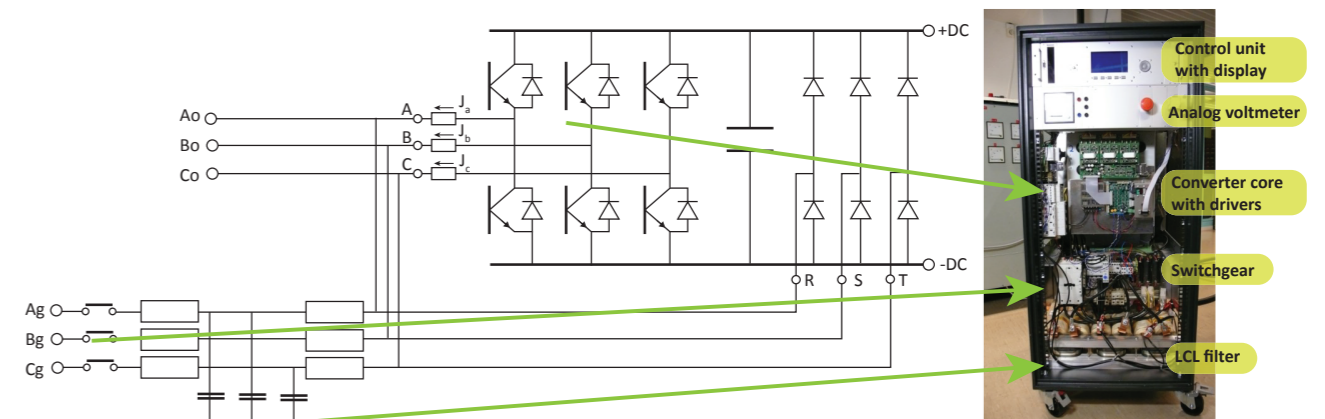

Schematic and physical converters

FLEXIBLE RESOURCES IN THE POWER SYSTEM (WP5)

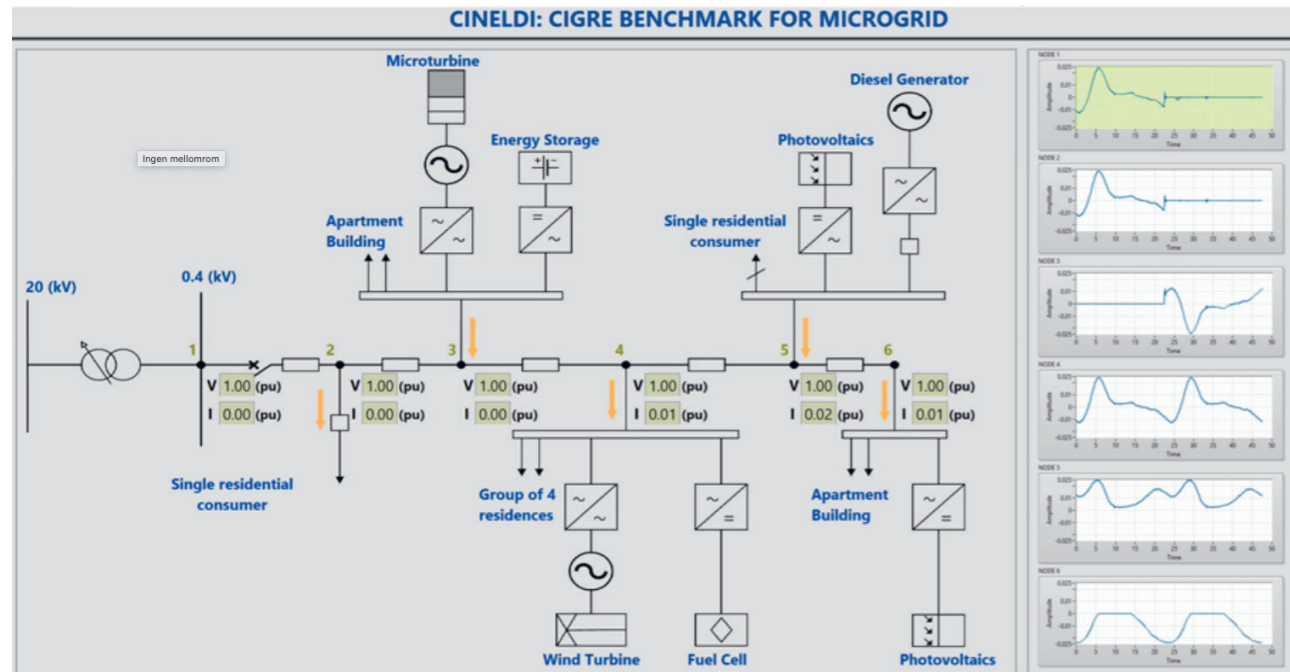

LabVIEW interface



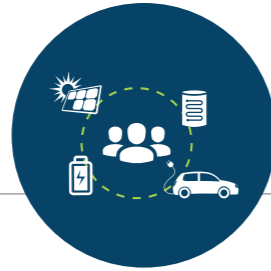

The overall objective of WP5 is to develop methods and models for cost effective integration of flexible resources in smart distribution grids.

We expect this to contribute to improved efficiency of the system operation when utilizing flexibility as an important asset in the power system – as a realistic alternative to grid investments and serving flexibility to the transmission level.

Incorporating energy storage and variable renewables in power flow analysis

The increasing penetration of wind power and solar PV introduces challenges to distribution grids, since these sources are associated with variability and uncertainty on multiple time scales, both within each hour, within each day, and over the year. Distribution system operators (DSOs) may therefore have to consider new flexible resources in both the operation and planning of the distribution system.

Energy storage is a class of flexible resources that has received considerable attention lately, by the research community as well as by system operators and end-users. The introduction of energy storage implies a multi-period operational planning problem since an amount of energy discharged by the energy storage at one time step will have to be charged at a previous time step. When the optimal operation of a distribution system is formulated as an alternating current (AC) optimal power flow (OPF) problem, the time-coupling introduced by grid-connected energy storage therefore transforms the problem to a multi-period OPF (MPOPF) problem over an operational planning horizon comprising multiple time steps.

We have therefore done research in 2019 to make sure that energy storage and variable renewables are taken into account in a realistic way in power flow analysis. Our approach is to explicitly take account for uncertainties in future generation and load to ensure a best possible operation decision for the energy storage, inspired by how hydropower producers plan their usage of stored reservoir water. The methods and models that we have developed are relevant for DSOs who are facing different challenges in planning and operation of their grid, such as:

1. Increasing amounts of prosumers connected to their grids, with home PV and batteries. The grid operators must be able to predict their net load profile, and also give right price or control signals for activating use of the home batteries for grid services.
2. Increasing amounts of medium-scaled distributed generation, such as smaller wind farms and solar PV farms. These can be located in areas where the grid is weak. Energy storage can be an alternative to grid reinforcements. Our models can be used to assess the storage alternative in a robust and effective way.
3. Increasing demand for electricity such as high-power charging of electric vehicles and ferries. In some cases, the vehicles themselves represent a source of flexibility, through smart charging and possible Vehicle-to-Grid (V2G) operation. In other cases, the vehicles need high amounts of power in a short time, and stationary energy storage can then be a viable alternative to costly grid reinforcements.

We have published the model and results from a Norwegian test case in a journal paper in 2019, and

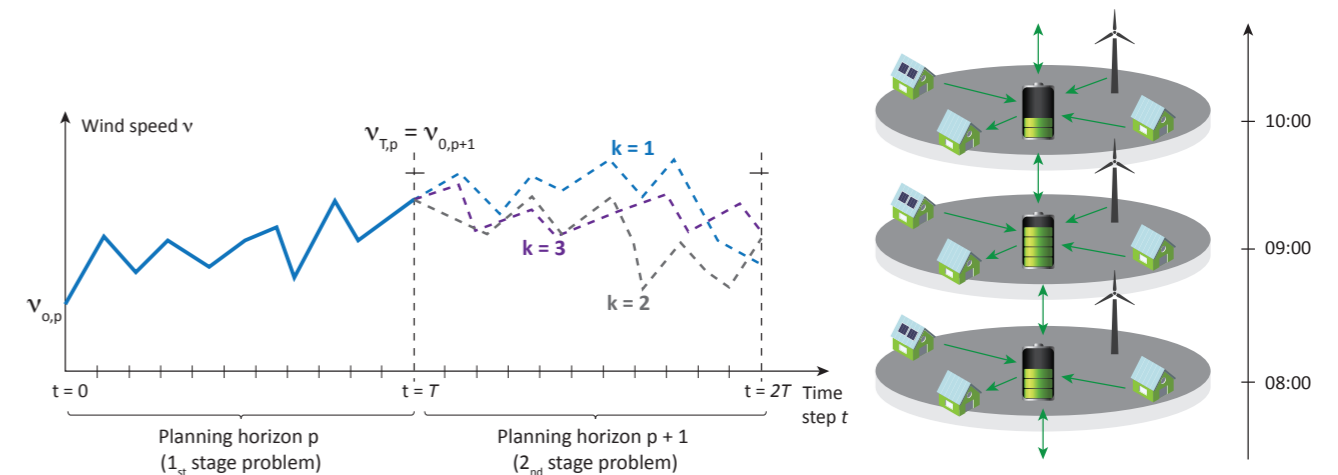

there are many possibilities for extensions and uses that are relevant for grid planners, such as modelling uncertainty in load due to charging of electrical vehicles, microgrid applications, grid congestions, outages, and/or sharp load peaks. Accounting for the expected value of lost load in setting the end-value of stored energy is particularly relevant for applications where energy storage is used for improving the reliability in constrained grids.

The presented model is a useful tool for grid owners who needs to investigate the integration of renewable energy sources, storage and flexible demand, taking into account both grid details, economics and the stochastic nature of wind, solar and demand.

Methods for cost benefit analysis of batteries in distribution grids

Battery Energy Storage Systems (BESSs) can be used for a range of applications in the power systems, such as load leveling, balancing of variable renewable energy sources (VRES), offer various ancillary services

and transmission & distribution grid deferral or a combination of applications. For the latter application, BESS' can be deployed at strategic locations of the transmission & distribution network and perform active and reactive power control for better utilization of the existing grid, as an alternative to costly structural upgrades. This usage of a BESS is relevant for areas with expected growth in demand, power quality issues and/or integration of a large amount of VRES.

However, since grid applications of BESS' are still in the early stages of deployment, there is still no consensus on recommended computational methods for performing cost-benefit analysis of BESS' as alternative for grid upgrades, or for other grid services. In contrast to traditional static grid assets (e.g. transmission lines), the benefits of BESS' depend upon the dynamics and the control strategy of how these are operated. Especially in grids with large amounts of VRES, the storage dynamics increase the system complexity and thereby will require more advanced computational methods for grid planning than presently employed in practice. The lack of established computational

SMART GRID SCENARIOS AND TRANSITION STRATEGIES (WP6)

methods for including BESS' in grid planning is a barrier for taking published research-based models into practice.

In 2019 we therefore performed a comprehensive and systematic overview of relevant computational methods reported in the literature.

We found it will be crucial for the grid operators to be able to include BESS in their planning procedures in a proper way, whether they are allowed to install BESS themselves or will rely on other actors to provide grid services. We find that for the research-based methods to be suitable for grid planning, several issues need to be accounted for: The methods should handle timing of installations as well as sizing and siting, especially for cases where BESS can be a temporary solution. Moreover, they must capture long-term development in the need triggering a grid planning measure (e.g. growth in load demand or PV). Finally, the methods for Cost-Benefit Analysis need a realistic modelling of the operational benefits of BESS. This comprises models that captures multi-period AC power flow with acceptable computation times, representative variations of load and generation over the year, realistic modelling of lifetime of the batteries, and last but not least multiple services and the trade-off between these services.

With this literature review as a foundation, it is now possible in CINELDI to develop Cost-Benefit Analysis that are in the research front, while focusing on the economic aspects of energy storage that are crucial for grid developers

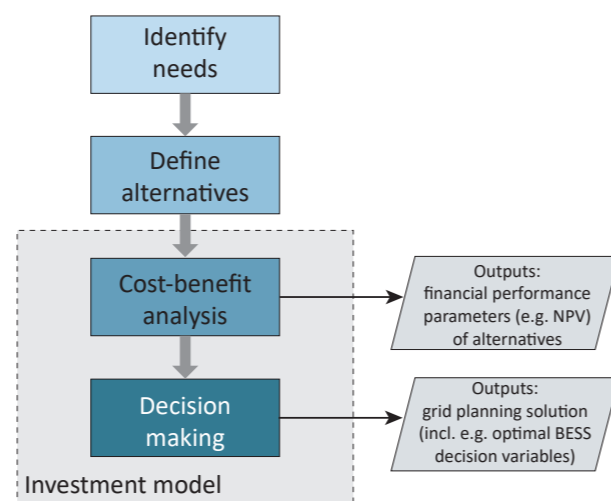



We are developing a credible set of Smart Grid visions and scenarios as input to the other work packages in CINELDI, and as a basis for fostering new ideas and innovation. We will also develop guidelines and recommendations for the transition to the flexible, robust, and cost-efficient electricity distribution system of 2030-2040, by integrating the results and findings from the other work packages into a holistic strategy.

By the end of CINELDI, our structured, multidisciplinary research will provide robust results for external requirements and opportunities for the future distribution system. These strategies and recommendations will be used by the electricity industry to update their local strategies, enabling the transition.

Driving forces for intelligent electricity distribution system innovation

The future grid of 2030-2040 will be a complex system-of-systems, incorporating various intelligent devices and technologies. On the cyber-physical electricity distribution system level, the interactions between various technological, economic, organisational, and human factors add complexity that needs to be addressed in a holistic and coordinated way in order to support system innovation and development.

We define system innovation as a co-evolution of system-level technical, social, economic and regulatory changes. The main driving forces for the distribution system innovation have been identified, with more than 100 mini scenarios developed for the electricity

distribution system in Norway. A mini scenario is a probable event, development or action of significance for the future electricity distribution system.

This work on scenarios was performed as a foresight process through workshops and meetings gathering all partners in CINELDI, supported with literature surveys and further studies. The foresight process is about thinking, debating and shaping the future. Apart from describing driving forces for implementing a smart distribution grid (See page 16 for more information about driving forces) and developing mini scenarios, four possible main scenarios for the future distribution system have been developed. This work relates to a system of coordinates, where the horizontal axis describes the grid customers and the vertical axis describes the grid itself.

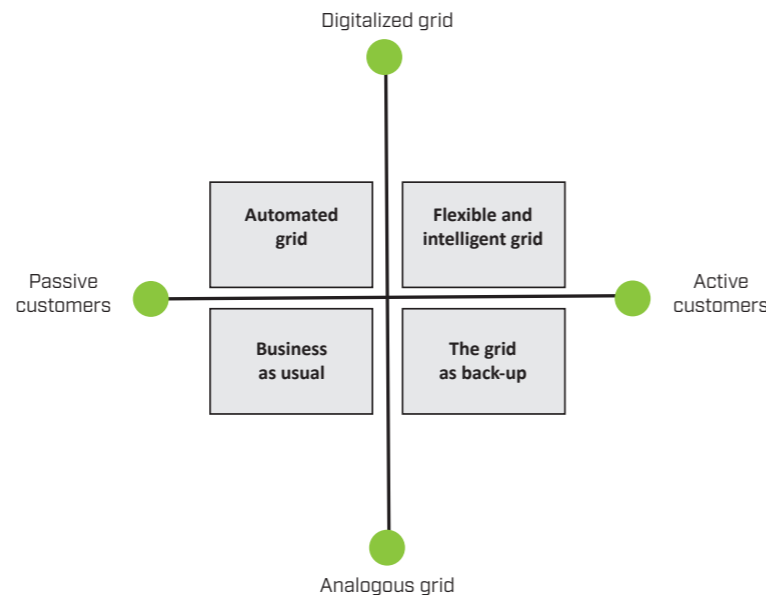

The endpoints of the horizontal axis define the passive and the active grid customers, respectively. Similarly, the endpoints of the grid axis define the analogous grid and the digitalized grid, respectively. The main scenarios arise from the interaction between the customer- and grid axes. Various driving forces (mega-trends, external- and grid related forces) will push the development in different directions.

The transition to the future flexible, intelligent, cost-efficient and robust distribution grid, requires each industry (grid companies, TSOs, technology providers and other stakeholders) to properly prepare for the future. Therefore we conducted a survey among CINELDI-partners to gain insight into how the results on driving forces and scenarios have been used already and how the partners plan to use the results in the future.

The results of the survey are shown below. The majority of the respondents will use the results to inform their research and development strategy, with half planning to use them to develop expertise, a demonstration/ pilot strategy, and their overall company strategy. We are very pleased with these results. They show our work in CINELDI has direct value for our user partners, and that grid companies are preparing for the necessary transition to the smart grid.

How likely is it that you will use the results for:

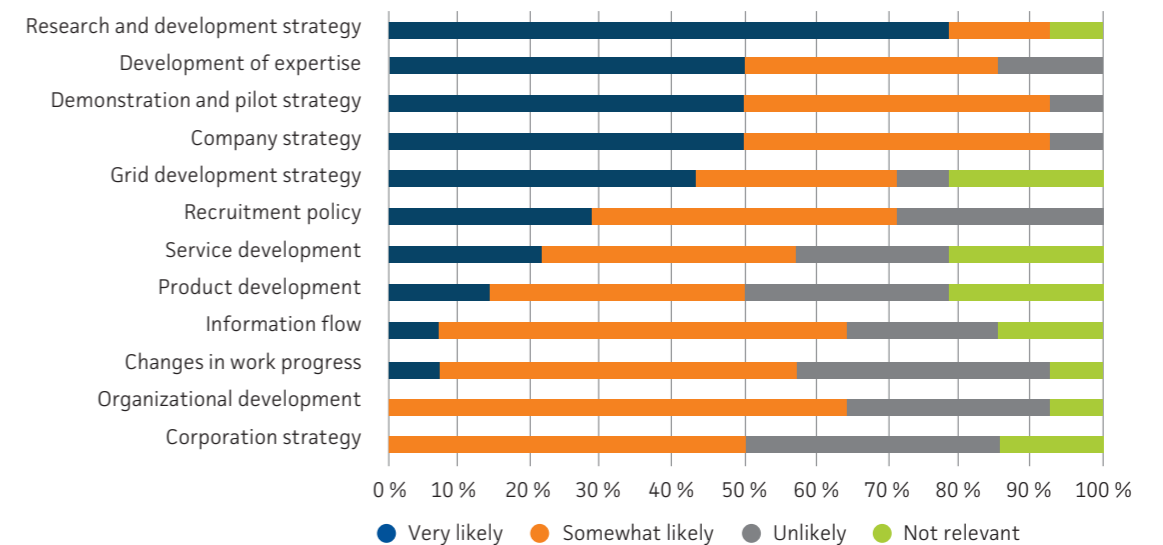

PILOT PROJECTS IN CINELDI

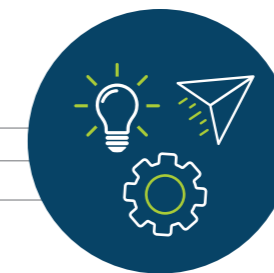

CINELDI develops knowledge, methods, and tools that will be tested in laboratories, simulated environments, and field pilots in the distribution network. The pilot projects are important parts of CINELDI and are an integrated part of the research and development in the Centre.

The pilot projects contribute to develop cost-efficient solutions and innovation on the system level of the future electricity distribution system of 2030-2040. They support the objectives and vision of CINELDI as well as the scenarios for the future distribution system developed in WP6.

The main objective of pilots in CINELDI is to test and verify technologies and solutions for the future intelligent electricity distribution system, in real environments.

In WP Pilot we define and structure pilot projects, facilitate coordination (including cooperation with Demo Norway) and follow-up progress and reporting of pilot projects in CINELDI.

CINELDI has decided on five priority areas for pilot projects. Each of the priority areas cover several of the work packages in CINELDI. This is illustrated below.

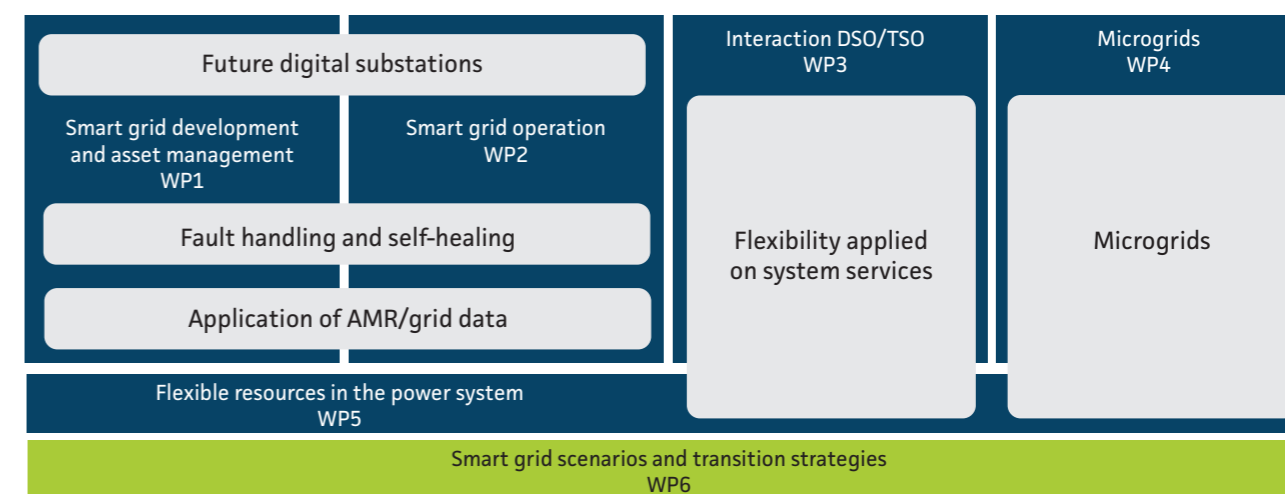

INTERNATIONAL COOPERATION

There are many pilot projects in progress in CINELDI. At the end of 2019 there were 24 pilots divided between the different priority areas (figure previous page). They had different statuses, from idea to on-going and finalised as illustrated below. Results are reported in the WP the pilot project belongs to.

Moving forward, more activity in the pilots in the priority areas microgrid, application of AMR/grid data and flexibility applied on system services is a top priority. It is important to involve more partners in ongoing pilots in order to ensure transfer of knowledge. Hence, dissemination from the pilots is essential. In 2019 there was pilot dissemination through WP-meetings, webinars and day number 2 of the CINELDI-days in November 2019 was dedicated to pilot projects.

Pilot projects divided by priority area

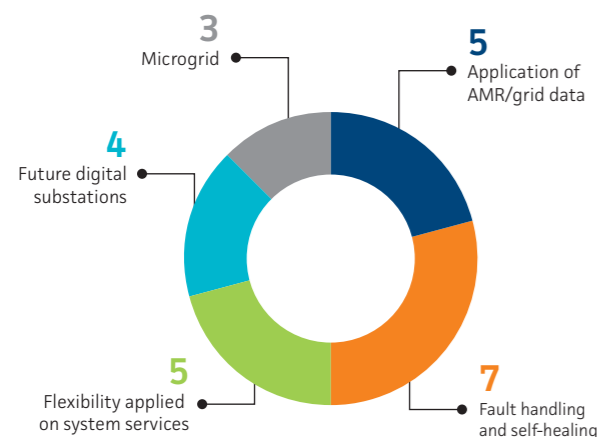

Pilot projects divided by status

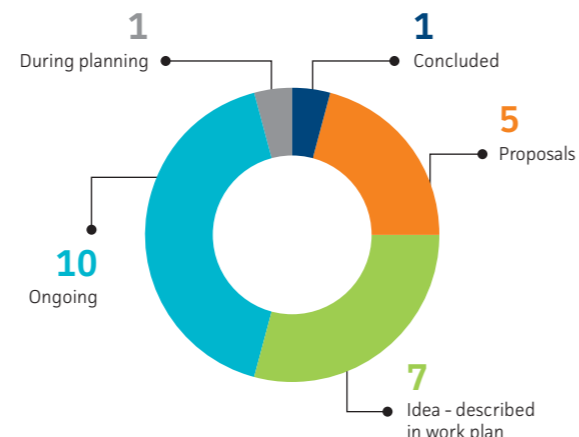

Scientific Committee (SC)

The purpose of CINELDI's international scientific committee is to give advice to the research in CINELDI, give input to the plans and new research topics, contribute to coordination of the research and laboratory activities between participating institutions and contribute to organisation and coordination of international research applications.

The scientific committee had the following members in 2019:

- Reader Ivana Kockar, University of Strathclyde, UK
- Director Angel Diaz, Tecnalia, Spain
- Professor Bruce Mork, Michigan Technological University, USA
- Professor Fabrizio Pilo, University of Cagliari, Italy
- Research Professor Kari Mäki, VTT, Finland
- Associate professor Mattia Marinelli, DTU, Denmark

Two meetings have been held with the SC in 2019, where status and plans for the six work packages in

CINELDI were presented and discussed. The PhDs and Postdoctors also presented their work for the SC with time for questions and comments. SC gave input to the plans for 2020, and ideas for possible project cooperation were discussed.

The CINELDI conference 2019

On April 9, 2019 the first CINELDI Conference "Future Electricity Distribution Grid R&D" was arranged. The target groups for the conference are the industry, students and researchers (national and international). The purposes of the conference are to present results from CINELDI and to discuss relevant issues where the answers are not yet clear. The topics for the conference were "Flexible resources to facilitate the smart grid transition" and "Smart grid communication and cyber security". Several members of the SC contributed with presentations (incl. keynote) and in the discussions. There was also a keynote speech from Anne Remke, University of Twente.

ERIGrid / CINELDI workshop on Smart Grid laboratory developments

On October 28 and 29, a workshop was arranged in Trondheim, in cooperation between the EU-project ERIGrid and CINELDI. ERIGrid is a H2020 project for research infrastructure. The workshop gathered around 30 participants, mainly researchers, and was about knowledge and experience exchange related to test- and validation methods for smart grid laboratory activities, with emphasis on co-simulation of ICT and power systems and "hardware-in-the-loop". The workshop included visits to both the Smart Grid laboratory at NTNU and SINTEF Energy Lab.



WP5 leader Magnus Korpås at the CINELDI Conference 2019



International cooperation in research activities

In WP1, there is an ongoing cooperation with University of Cagliari regarding a case study in the SPREAD tool on planning of active distribution networks.

WP2 have had a visit from a guest researcher from University of Passau, related to COST action CA15127 RECODIS, in cooperation with NTNU IIK (department of information security and communication technology), on the topic «Dependability of cyber-physical system under disaster events» (case: smart grid). A joint paper is under preparation.

In WP3, researchers have participated in four meetings in the CIGRE WG6 C6/C2.34 "Flexibility provision from distributed energy resources". WP3 has also had cooperation with the H2020 project SmartNet.

WP4 had visits from two exchange students (PhD) within microgrids. There has also been cooperation with an associated PhD student in the COPE project. A cooperation between Dehli Technological University (DTU), Indian Institute of Technology (IIT-Dehli) and NTNU on PhD exchange is being planned. Two PhD students from IIT-Dehli have visited NTNU for one month in 2019. WP4 is also in contact with IMDEA in Spain regarding access to their facilities in Madrid and experiences with harmonic compensator related to harmonic sharing in parallel-connected inverters.

In WP5 there is cooperation with European Energy Research Alliance (EERA) in JP Smart Grids, sub program for Energy Storage related to techno-economic benefit of stationary energy storage in the grid. SINTEF Energi

and NTNU participates together with VTT, Fraunhofer, AIT and DTU (Denmark).

WP5 lead Magnus Korpås was on research stay at MIT Laboratory for Information and Decision Systems in 2019, and parts of the research conducted there is related to WP5, i.a. optimization of energy storage.

In WP6 there has been some cooperation with the EU project PAN-T-ERA, which started in 2019.

EU cooperation: H2020, ERA-NET and EERA

CINELDI has established cooperation with several EU H2020 projects. In 2019 there has been cooperation with the SmartNet project in WP3 in CINELDI. WP5 cooperates with the INVADE project, while WP6 cooperates with PAN-T-ERA. The recently started FlexPlan will be cooperating with WP1, WP2 and WP6 in CINELDI. In addition, CINELDI cooperates with the ERA-Net projects SmartGuide, MATCH and IHSMAG.

CINELDI has also contributed in several applications to the H2020 program, for different calls, i.a. FlexPlan and PAN-T-ERA, which both have started, and the DeSiMod application to call LC-SC3-EE-14-2019: Socio-economic research conceptualizing and modelling energy efficiency and energy demand.

Further, CINELDI is invited to National Advisory Board for the Smart City project +CityxChange (<https://cityxchange.eu/>).

The EERA cooperation is mentioned above. CINELDI also cooperates with EERA JP Smartgrids to arrange their board meeting in connection to the CINELDI

conference in Trondheim in April 2020. Conference contributions from EERA has also been planned.

India-Norway and China-Norway cooperation

CINELDI cooperates with the ROME project, financed under the India-Norway program, regarding planning and operation of microgrids.

CINELDI has also contributed in applications with other FMEs to the MOST call under the China-Norway program: the projects ChiNo-ZEN and KeyTech-NeVe-ChiNo. Both of these were granted funding in November 2019.

Participation in international fora









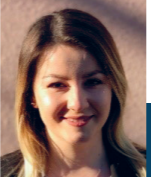

Active participation in international standardisation bodies, networks and expert groups is strategically important for influencing the development within Smart Grids through knowledge sharing, innovation and standardisation. CINELDI partners are participating in various international fora:

- IEC TC8, IEC System Committee Smart Energy, and CENELEC TC8X: Kjell Sand is a member of the International Standardisation Committees
- Mission Innovation: Kjell Sand is a Norwegian representative in the Mission Innovation challenge no 1 - #IC1 on Smart Grids on behalf of the Norwegian Ministry of Petroleum and Energy, the Research Council of Norway and FME CINELDI.

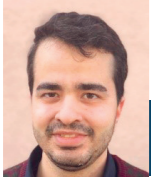
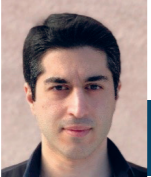
- ETIP SNET: Grete Coldevin is co-chair in the National Stakeholders Coordination Group.
- ETIP SNET: Andrei Z. Morch member of WG5 "Innovation implementation in the business environment"
- ISGAN: Hans Terje Ylvisåker is the regular member, while Grete Coldevin is the alternate member of the Executive Committee on behalf of the Norwegian Ministry of Petroleum and Energy.
- EERA JP Smart Grids, SP on Energy Storage: Magnus Korpås is a sub-task leader for Economic evaluation of energy storage.
- EERA JP Smart Grids: SINTEF Energi (Knut Samdal) is the leader of SP5 "Flexible Transmission Networks" and member of the Steering Committee
- EERA JP Energy System Integration: Olav Fosso is NTNUs representative.
- CIREC: Gerd Kjølle and Oddbjørn Gjerde are members of the Working Group on Resilience of Distribution Grids.
- CIREC: Dag Eirik Nordgård is a member of the Directing Committee
- CIGRE: Dag Eirik Nordgård is a member of the Study Committee C6 Distribution systems and Dispersed generation.
- CIGRE JWG C6/C2.34 "Flexibility provision": Hanne Sæle and Andrei Morch are members of the working group.
- IEA Task 25 Collaboration on wind and solar integration and use of flexibility: Magnus Korpås is a member.
- PSCC: Magnus Korpås is a technical committee member.

RECRUITMENT

Overview of recruited PhDs and Postdocs within CINELDI

 Michele Garau Period: 2018-2021 Position: Postdoc	 Stine Fleischer Myhre Period: 2019-2022 Position: PhD	 Romina Muka Period: 2018-2022 Position: PhD	 Fredrik Bakkevig Haugli Period: 2017-2021 Position: PhD
 Mohammad Ali Abooshahab Period: 2017-2020 Position: PhD	 Güray Kara Period: 2017-2020 Position: PhD	 Mario Blazquez De Paz Period: 2017-2019 Position: Postdoc	 Kalpanie Mendis Period: 2018-2022 Position: PhD
 Fredrik Göthner Period: 2017-2020 Position: PhD	 Kasper Thorvaldsen Period: 2018-2022 Position: PhD	 Ingvild Fjellså Period: 2017-2020 Position: PhD	

During 2019 one additional PhD was recruited, and in total there are now nine PhDs and two Postdocs working at CINELDI during the first research phase. A total overview is presented on the previous page.

In 2019, 302 people were involved in CINELDI in total. 57 researchers from SINTEF Energy Research, NTNU and SINTEF Digital participated in the work (including centre management), and 194 representatives from the 27 user partners were involved. Among the students related to NTNU, there were nine PhDs and two Postdocs funded by CINELDI, and seven PhDs and two Postdocs cooperating with CINELDI, with funding from other sources. Five guest researchers cooperated with CINELDI in 2019. The number of involved persons has increased compared to 2018.

At NTNU, 26 master students concluded their MSc in cooperation with CINELDI in 2019. These students worked on their project theses during the autumn 2018 and delivered their master thesis during 2019. Among the researchers and students, the gender distribution was 66% men vs. 34% women. Among the researchers there were 30% women, and among the master students there were 50% women. The share of women among the PhDs/Postdocs funded by CINELDI is 36% (4 out of 11 in 2019).

COMMUNICATION

Communication strategy

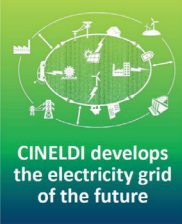
Vision	Why? FME Goal	Who? Target groups	What? Message	How? Channel/media	Results
 <p>CINELDI develops the electricity grid of the future</p>	<p>In order to become a success in:</p> <ul style="list-style-type: none"> research activity innovation/value creation internationalisation training/recruitment funding organisation 	<ul style="list-style-type: none"> Industry Politicians Funding parties: RCN/EU+ Public/NGOs Partners in the centre International research organisations 	<p>Smart Grids is a prerequisite for</p> <ul style="list-style-type: none"> the green transition new renewables electrification of transport energy efficiency <p>The consumer is a resource in the future energy system</p> <p>CINELDI will contribute to a flexible and robust smart grid at an acceptable cost.</p>	<ul style="list-style-type: none"> Webpage Scientific dissemination #SINTEFblog Media Events Newsletter Annual report SoMe Webinars 	<p>KPI: Increased visibility and knowledge</p> <p>KPI: Increased positive reputation</p> <p>KPI: Increased internal engagement</p> <p>Achieving FME goals</p>

← evaluation - reporting - learning →

Communicating results to partners as well as non-CINELDI participants is a vital activity. The main platform for communicating results to the outside world is the website (www.cineldi.no), where all open results are published. In 2019, we continued sending newsletters at least every two months as well as continuing our exclusive partner newsletter.

Great emphasis is placed on encouraging researchers to produce blogposts about their results and activities. These blogposts are increasingly popular. As are the videos produced about CINELDI.

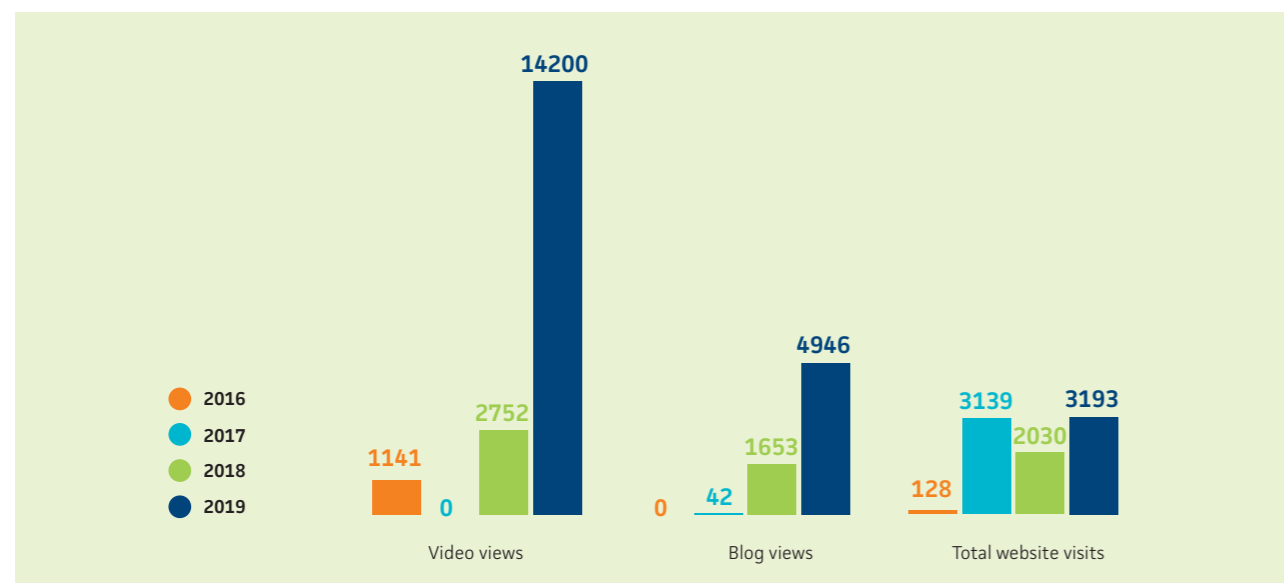

Web

The CINELDI webpage provides information about the Centre, its research and other activities like events and conferences.

Newsletter

The CINELDI newsletter mainly goes to the Consortium but is also open to external subscribers. In 2019, 6 newsletters were sent out, providing information about CINELDI events, research, blogposts, media coverage etc.

- December 19, 2019 CINELDI - Smart grid driving forces, co-simulation, batteries in the grid and the CINELDI-days
- October 31, 2019 Interruption handling and CINELDI PhDs - CINELDI-october 2019
- August 30, 2019 CINELDI Newsletter August 2019
- June 20, 2019 CINELDI Newsletter June 2019
- April 4, 2019 CINELDI Newsletter April 2019
- February 26, 2019 CINELDI Newsletter February 2019



Twitter

The CINELDI Twitter account (@CINELDI_FME) is used to share news about Centre activities, popular science publications like videos, posts on #SINTEFBlog and conference news. The target groups of the account are consortium members, potential partners, researchers, policy makers (domestic and international) and the “interested public”.

In 2019, CINELDI had:



The most popular tweet of 2019 was the 2018 Annual Report video where Centre director Gerd Kjølle looks back at the research highlights of 2018.



This tweet had:

- 8383 views
- 361 video views
- 84 engagements (i.e. retweets, likes, etc.)

Media

CINELDI had record high media coverage in 2019, with the power-industry magazine Energiteknikk dedicating an entire annex to CINELDI as a clear highlight. Here are three examples of CINELDI media coverage in 2019:

#1: Energiteknikk

The CINELDI- annex presented a wide variety of CINELDI research and innovation work. Energiteknikk is distributed to approx. 20. 000 people within the Power-industry, giving CINELDI exceptional coverage towards industry.



#2: Radio interview about power-outage in Argentina.

Centre Director Gerd Kjølle was interviewed on NRK RADIO in June about the blackout in South America, where 48 million people lost their electricity. She shared her thoughts on security of electricity supply, if it can happen in Norway, and how CINELDI is doing research to ensure security of supply.



#3: Q&A on microgrids in Teknisk Ukeblad

CINELDI Research Scientist Bendik Torsæter was interviewed about Microgrids in Norway's biggest technology and business magazine, TU, which reaches more than 250 000 people with each issue.

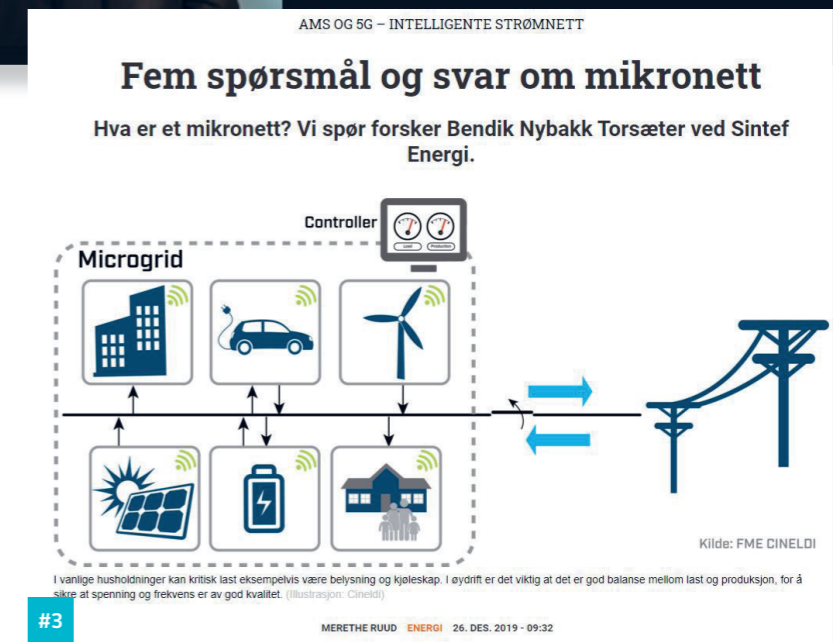

APPENDICES

Blog

CINELDI has published 18 blogposts on the SINTEFBlog (Both Norwegian and English) in 2019, with a total of 5000 readers. Most blog posts highlight CINELDI research published in scientific publications. The blogs are written in a popular science style, aimed at other

researchers (working both in and outside the research field) and people working in the power industry.

The top three blog posts of 2019 were:

#ENERGY / GRID/SMARTGRIDS

Electric vehicles in Norway and the potential for demand response

Changing to non-emission transport can result in approximately 1.5 mill. private electric vehicles by 2030, resulting in an energy need of 4 TWh....





 818 readers

#ENERGY / ELECTRIC POWER COMPONENTS / ENERGY SYSTEMS / GRID/SMARTGRIDS

Microgrids: What are they, virtual impedance and a control concept for inverters in islanded microgrids

Due to the desire to shift towards a more sustainable energy system, new renewable energy sources are being integrated in the distribution grid....





 385 readers

#DIGITAL / #ENERGY / GRID/SMARTGRIDS

How to estimate flexibility potential of household appliances? (To reduce peak load)

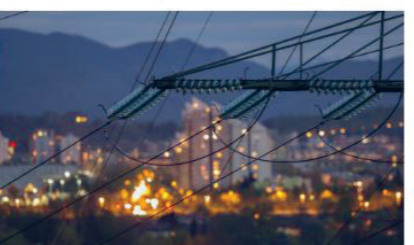
Due to the ageing distribution network infrastructure, the increasing integration of renewable energy generation and the increasing customer load demand, the need for...



 369 readers

Personnel

Key Researchers

Name	Institution	Main research area
Andrei Z. Morch	SINTEF Energy Research	Interaction DSO/TSO
Bendik Nybakk Torsæter	SINTEF Energy Research	Microgrids
Eivind Solvang	SINTEF Energy Research	Smart grid development and asset management
Gerd Hovin Kjølle	SINTEF Energy Research	Smart grid scenarios and transition strategies
Hanne Sæle	SINTEF Energy Research	Interaction DSO/TSO
Hanne Vefsnmo	SINTEF Energy Research	Smart grid development and asset management
Henning Taxt	SINTEF Energy Research	Smart grid operation
Iver Bakken Sperstad	SINTEF Energy Research	Flexible resources in the power system
Jørn Foros	SINTEF Energy Research	Smart grid development and asset management
Rakel Alice Holt	SINTEF Energy Research	Microgrids
Jorun Irene Marvik	SINTEF Energy Research	Microgrids
Linn Tabita Milde	SINTEF Energy Research	Centre Management
Kjell Ljøkelsøy	SINTEF Energy Research	Smart grid operation
Salvatore d'Arco	SINTEF Energy Research	Flexible resources in the power system
Santiago Sanchez-Acevedo	SINTEF Energy Research	Microgrids
Kristian Wang Høiem	SINTEF Energy Research	Microgrids
Sigurd Hofsmo Jakobsen	SINTEF Energy Research	Smart grid scenarios and transition strategies
Aurora Marie Fosli Flataker	SINTEF Energy Research	Smart grid operation
Karoline Ingebrigtsen	SINTEF Energy Research	Smart grid operation
Kristian Wang Høiem	SINTEF Energy Research	Smart grid operation
Magne Lorentzen Kolstad	SINTEF Energy Research	Microgrids
Maren Istad	SINTEF Energy Research	Smart grid operation
Matthias Resch	SINTEF Energy Research	Microgrids
Merkebu Zenebe Degefa	SINTEF Energy Research	Interaction DSO/TSO
Oddbjørn Gjerde	SINTEF Energy Research	Smart grid development and asset management
Raymundo E. Torres-Olguin	SINTEF Energy Research	Microgrids
Tonje Skoglund Hermansen	SINTEF Energy Research	Smart grid development and asset management
Kjell Sand	NTNU IE, IEL	Smart grid operation
Hossein Farahmand	NTNU IEL	Flexible resources in the power system
Thomas S. Haugan	NTNU IEL	Microgrids
Magnus Korpås	NTNU IEL	Flexible resources in the power system
Olav B. Fosso	NTNU IEL	Microgrids
Kjetil Uhlen	NTNU IEL	Interaction DSO/TSO



Name	Institution	Main research area
Irina Oleinikova	NTNU IEL	Interaction DSO/TSO
Poul Heegaard	NTNU IIK	Smart grid operation
Bjarne Helvik	NTNU IIK	Smart grid operation
Sule Yildirim-Yayilgan	NTNU IIK	Smart grid operation
Morten Hovd	NTNU ITK	Interaction DSO/TSO
Asgeir Tomasgard	NTNU IØT	Smart grid scenarios and transition strategies
Pedro Andres Crespo del Granado	NTNU IØT	Interaction DSO/TSO
Marianne Ryghaug	NTNU KULT	Flexible resources in the power system
Tomas Moe Skjølsvold	NTNU, KULT	Flexible resources in the power system
Karin Bernsmed	SINTEF Digital	Smart grid operation
Bjørn Magnus Mathisen	SINTEF Digital	Smart grid operation
Kristoffer Nyborg Gregertsen	SINTEF Digital	Interaction DSO/TSO
Ketil Stølen	SINTEF Digital	Smart grid development and asset management
Åsmund Hugo	SINTEF Digital	Smart grid development and asset management
Geir Mathisen	SINTEF Digital	Smart grid operation
Inger Anne Tøndel	SINTEF Digital	Smart grid development and asset management
Sture Holmstrøm	SINTEF Digital	Microgrids
Marie Elisabeth Gaup Moe	SINTEF Digital	Smart grid operation
Christian Frøystad	SINTEF Digital	Smart grid operation
Martin Gilje Jaatun	SINTEF Digital	Smart grid operation
Borgaonkar Ravishankar	SINTEF Digital	Smart grid operation
Aida Omerovic	SINTEF Digital	Smart grid development and asset management
Giancarlo Marafioti	SINTEF Digital	Microgrids
Henrik Lundqvist	SINTEF Digital	Interaction DSO/TSO

Visiting Researchers

Name	Affiliation	Nationality	Sex	Duration	Topic
Amit Patil	University of Passau	India	M	22.04-29.04.19/ 26.08-30.08.19	Dependability of cyber-physical system under disaster events
Rubi Rana	IIT- Delhi	India	F	1 mnd	Microgrid (operation and control strategies)
Ayesha Firdaus	IIT- Delhi	India	F	1 mnd	Stability analysis in microgrid
Dushyant Sharma	IIT- Delhi	India	M	1 week	Microgrid
Mehdi Jafari	MIT Laboratory of Information and Decision Systems, Massachusetts, USA	Iran	M	27.08.19-20.09.19	Flexibility from battery energy storage

Postdoctoral researchers with financial support from the Centre budget

Name	Nationality	Period	Sex	Topic
Michele Garau	Italy	2018-2020	M	Modelling of Interactions and Interdependencies in Complex Systems of Power Grid and ICT Systems
Mario Blazquez De Paz	Spain	2017-2020	M	Designing electricity markets in the presence of renewables and elastic demand

Postdoctoral researchers working on projects in the centre with financial support from other sources

Name	Funding	Nationality	Period	Sex	Topic
Chendan Li	NTNU	Kina	01/2019 – 01/2021	F	Control strategies for microgrid
Soumya Das	ROME	India	06/2019 – 06/2021	M	Planning and operation of microgrid

PhD students with financial support from the Centre budget

Name	Nationality	Period	Sex	Topic
Stine Fleischer Myhre	Norway	2019-2022	F	Risk and vulnerability in the future intelligent electricity distribution system
Romina Muka	Albania	2018-2021	F	Self-Healing and Autonomous Smart Grid Operation
Fredrik Bakkevig Haugli	Norway	2017-2021	M	Distributed and centralized control to support smart grid operation with high quality in a cost-efficient way
Mohammad Ali Abooshabab	Iran	2017-2020	M	Distributed and hierarchical dynamic state estimation for smart distribution grids
Güray Kara	Turkey	2017-2020	M	Techno-economic optimization for analysing consumer flexibility and related market structures
Kalpanie Mendis	Sri Lanka	2018-2022	F	5G for Low-Latency, Secure, and Dependable Communication Services for Fault Handling in Micro Grids
Fredrik Göthner	Norway	2017-2020	M	Smart power control in microgrids with modern power converters
Kasper Emil Thorvaldsen	Norway	2018-2022	M	The value of buildings' energy flexibility in the power market
Ingvild Firman Fjellså	Norway	2017-2021	F	Understanding mechanisms and incentives for motivating user flexibility

PhD students working on projects in the centre with financial support from other sources

Name	Funding	Nationality	Period	Sex	Topic
Mostafa Barani	RSO-TSO Energi, NTNU	Iran	2018-2021	M	Reliability Studies in Information and Communication Technology (ICT)-dominated Power Systems
Charles Adhra	ProSmart	Ghana	2015-2019	M	Communication Networks For Protection Systems In Smart Transmission Grids
Tesfaye Zerihun	NTNU	Etiopia	2015-2020	M	A holistic approach to dependability modeling and analysis of Smart Distribution Grids

Name	Funding	Nationality	Period	Sex	Topic
Matthias Hofmann	Industry PhD Statnett	Tysk	2018-2021	M	Demand-side flexibility as an alternative to investments in the transmission grid
Sjur Føyen	NTNU	Norsk	08/2018 – 08/2022	M	Control strategies for microgrid
Per Aaslid	SINTEF	Norsk	08/2018 – 08/2021	M	Integration of renewable energy sources - coordination of storage
Sigurd Bjarghov	NTNU - DigEco project	Norsk	2018-2022	M	Market design for integration of renewable energy
Maciej Grebla	NTNU - ProSmart	Poland	2017-2020	M	Power system protection in microgrids

Master degrees

Name	Sex	Topic
Tonje Leine Lunden	F	Analyse av forbruksmålinger fra smarte nettstasjoner for planlegging og drift av distribusjonsnett
Torbjørn Slinde	M	Prosesstøtte og visualisering i neste generasjons asset management
Nathalie Skyttermoen	F	A Method for Planning a Fast Charging Station
Marte Brurås	F	Impact of Fast Charging Stations on the Reliability of Electricity Supply in Distribution Networks
Fredrik Heistad	M	Prediksjon av feil i det norske strømmettet
William Andreas Kristensen	M	Prediksjon av feil i det norske strømmettet
Marius Lervik	M	System for acquisition and analyzing of data from smart meters
Bernt Johan Damslora	M	Data collection in a cellular sensor network with nRF9160
Ingvild Skaftun	F	Effektforbruk ved svømmeanlegg (Pirbadet)
Mats Kornelius Karlsen	M	Energioptimalisering og mikrogrid, Granåsen skisenter
Kjersti L. Runestad	F	Adaptive Protection of an Inverter- Dominated Microgrid and Testing at the Smart Grid Laboratory at NTNU
Martine Johanne Nordengen Baksvær	F	EMD and Online EMD for Harmonic Detection in Power Systems
Jonas Riseth	M	Interaction Strategies for an Optimal Grid Integration of Microgrids
Stine Flesicher Myhre	F	Interaction Strategies for an Optimal Grid Integration of Microgrids
Håkon Eidsvik	M	Dynamic simulation of power systems based on a second-order predictor-corrector scheme
Hege Bruvik Kvandal	F	Toolbox for specialized power system analysis
Oda Hjelme	F	Optimal PV Inverter Active and Reactive Power Control in Distribution Grids With High Amounts of Solar PV
Line Nyegaard	F	Multi-Period AC Optimal Power Flow for Distribution Systems with Energy Storage
Mathias Kjølleberg Førland	M	SDN - a crucial security component towards 5G

Name	Sex	Topic
Siri Førstund Bjerland,	F	Modelling coordination schemes for the transmission and distribution system operators in the power system
Hanne Høie Grøttum	F	Modelling coordination schemes for the transmission and distribution system operators in the power system
Guro Sæther	F	Peer-to-Peer Energy Trading in Combination with Local Flexibility Resources in a Norwegian Industrial Site
Mathias Melby	M	Comparison of virtual oscillator control and droop control in an inverter-based stand-alone microgrid
Steinar Halsne	M	Stabilitetsvurdering ved Nettimpedansmetoden og Adaptiv Kontroll
Ola Mathias Almanning	M	Reducing Neighborhood Peak Load with a Peer-to-Peer Approach under Subscribed Capacity Tariffs
Rodrigo Villanueva Revenga	M	A Shortterm assessment of flexibility analyzing different levels of VRES deployment in a Unit Commitment model
Andreas Rise Mathisen	M	Continuous-Time Unit Commitment using spline interpolation

Statement of Accounts

(All figures in 1000 NOK)

As an option the funding and cost for each partner may be presented and also how funding and cost is allocated to the subprojects in the centre.

Funding

	Amount	In-kind	Sum
The Research Council	25773		25773
The Host Institution (SINTEF Energi)		6116	6116
Research Partners			
NTNU		2190	2190
SINTEF Digital		2393	2393
Enterprise partners			
DSOs	3628	8177	11806
TSO	265	244	508
Vendors	291	3185	3477
Member organisations	159	377	536
Public partners			
Authorities	159	291	449
Sum	30275	22973	53248
Costs			
The Host Institution (SINTEF Energi)	17179,8	6116,2	23296
Research Partners	8736,5	2189,8	10926
	4358,7	2393,4	6752
Enterprise partners		11983,2	11983
Public partners		290,6	291
Sum			53248

PUBLICATIONS 2019

Peer reviewed Journal publications

From: 2019 To: 2019 sub-category: Academic article
sub-category: Academic literature review sub-category:
Short communication All publishing channels

- Adrah, Charles Mawutor; Yellajosula, Jaya R. A. K.; Kure, Øivind; Palma, David; Heegaard, Poul Einar.**
An IP Multicast Framework for Routable Sample Value Communication in Transmission Grids.
Journal of Communications 2019 ;Volume 14.(9) p. 765-772
NTNU
- Berglund, Frida; Zaferanlouei, Salman; Korpås, Magnus; Uhlen, Kjetil.**
Optimal Operation of Battery Storage for a Subscribed Capacity-Based Power Tariff Prosumer—A Norwegian Case Study. *Energies* 2019 ;Volume 12.(23) p. -
NTNU
- Bernsmed, Karin; Jaatun, Martin Gilje; Frøystad, Christian.**
Is a Smarter Grid Also Riskier? Lecture Notes in Computer Science (LNCS) 2019 ;Volume 11738. p. 36-52. SINTEF
- Bitmead, Robert R.; Hovd, Morten; Abooshahab, Mohammad Ali.**
A Kalman-filtering derivation of simultaneous input and state estimation. *Automatica* 2019 ;Volume 108. p. -
NTNU
- Foros, Jørn; Istad, Maren Kristine; Morch, Andrei Z; Mathisen, Bjørn Magnus.**
Use case applying machine-learning techniques for improving operation of the distribution network.
CIREC Conference Proceedings 2019. ENERGISINT SINTEF
- Hermansen, Tonje Skoglund; Vefsnmo, Hanne; Kjølle, Gerd Hovin; Sand, Kjell.**
Driving forces for intelligent distribution system innovation - results from a foresight process.
CIREC Conference Proceedings 2019. ENERGISINT NTNU
- Hofmann, Matthias; Lindberg, Karen Byskov.**
Price elasticity of electricity demand in metropolitan areas – Case of Oslo. *International Conference on the European Energy Market* 2019 ;Volume 2019-September.
NTNU SINTEF
- Lillebo, Martin; Zaferanlouei, Salman; Zecchino, Antonio; Farahmand, Hossein.**
Impact of large-scale EV integration and fast chargers in a Norwegian LV grid. *The Journal of Engineering* 2019
NTNU
- Mendis, Handunneththi V. Kalpanie; Heegaard, Poul Einar; Krlevska, Katina.**
5G Network Slicing as an Enabler for Smart Distribution Grid Operations. *CIREC Conference Proceedings* 2019 p. 1-5
NTNU
- Skjølvold, Tomas Moe; Fjellså, Ingvild Firman; Ryghaug, Marianne.**
Det fleksible mennesket 2.0: Om sosiale relasjoner i fremtidens digitale elektrisitetssystem. *Norsk sosiologisk tidsskrift* 2019 ;Volume 3.(3) p. 191-208. NTNU
- Sperstad, Iver Bakken; Korpås, Magnus.**
Energy Storage Scheduling in Distribution Systems Considering Wind and Photovoltaic Generation Uncertainties. *Energies* 2019 ;Volume 12.(7)
ENERGISINT NTNU
- Villanueva Revenga, Rodrigo; Crespo del Granado, Pedro; Oleinikova, Irina; Farahmand, Hossein.**
A Minute-To-Minute Unit Commitment Model to Analyze Generators Performance.
International Conference on the European Energy Market 2019 ;Volume 2019-September. NTNU
- Zecchino, Antonio; D'Arco, Salvatore; Endegnanew, Atsed Gualu; Korpås, Magnus; Marinelli, Mattia.**
Enhanced primary frequency control from EVs: a fleet management strategy to mitigate effects of response discreteness. *IET Smart Grid* 2019 ;Volume 2.(3)
p. 436-444. ENERGISINT NTNU
- Zepter, Jan Martin Wilhelm; Lüth, Alexandra Rebecca; Crespo del Granado, Pedro; Egging, Ruud.**
Prosumer integration in wholesale electricity markets: Synergies of peer-to-peer trade and residential storage. *Energy and Buildings* 2019 ;Volume 184. p. 163-176. NTNU



Peer-reviewed papers

From: 2019 To: 2019 sub-category: Academic chapter/article/
Conference paper All publishing channels

1. **Aaslid, Per; Belsnes, Michael Martin; Fosso, Olav B. Optimal microgrid operation considering battery degradation using stochastic dual dynamic programming. I: 2019 International Conference on Smart Energy Systems and Technologies - SEST.** IEEE 2019 ISBN 978-1-7281-1156-8. ENERGISINT NTNU
2. **Abooshahab, Mohammad Ali; Hovd, Morten; Bitmead, Robert R. Disturbance and State Estimation in Partially Known Power Networks. I: Proceedings of the IEEE2019 Conference on Control Technology and Applications.** IEEE 2019 ISBN 978-1-7281-2766-8. p. 98-105. NTNU
3. **Almenning, Ola Mathias; Bjarghov, Sigurd; Farahmand, Hossein. Reducing Neighborhood Peak Loads with implicit Peer-to-Peer energy trading under Subscribed Capacity tariffs. I: 2019 International Conference on Smart Energy Systems and Technologies - SEST.** IEEE 2019 ISBN 978-1-7281-1156-8. NTNU
4. **Borgaonkar, Ravishankar Bhaskarrao; Jaatun, Martin Gilje. 5G as an Enabler for Secure IoT in the Smart Grid : Invited Paper. I: 2019 First International Conference on Societal Automation.** IEEE 2019 ISBN 978-1-7281-3345-4. SINTEF
5. **Degefa, Merkebu Zenebe; Sæle, Hanne; Andresen, Christian Andre. Analysis of Future Loading Scenarios in a Norwegian LV Network. I: 2019 International Conference on Smart Energy Systems and Technologies - SEST.** IEEE 2019 ISBN 978-1-7281-1156-8. ENERGISINT
6. **Føyen, Sjur; Fosso, Olav B; Zhang, Chen; Molinas Cabrera, Maria Marta. Frequency Domain Modelling for Assessment of Hilbert and SOGI Based Single-Phase Synchronisation. I: Proceeding 45th Annual Conference of the IEEE Industrial Electronics Society - IECON 2019.** IEEE conference proceedings 2019 ISBN 978-1-7281-4878-6. NTNU
7. **Göthner, Fredrik T. B. W.; Brandao, Danilo; Tedeschi, Elisabetta. Unbalanced Load Compensation by PowerBased Control in the Synchronous Reference Frame. I: 2019 10th International Conference on Power Electronics and ECCE Asia - ICPE 2019 - ECCE Asia.** IEEE 2019 ISBN 978-89-5708-313-0. p. - NTNU
8. **Göthner, Fredrik T. B. W.; Midtgård, Ole-Morten; Torres Olguin, Raymundo E.; Roldan-Pérez, Javier. Virtual Impedance Design for Power Quality and Harmonic Sharing Improvement in Microgrids. I: 2019 20th Workshop on Control and Modeling for Power Electronics - COMPEL.** IEEE 2019 ISBN 978-1-7281-1842-0. ENERGISINT NTNU
9. **Grøttum, Hanne Høie; Bjerland, Siri Førsund; Crespo del Granado, Pedro; Egging, Ruud. Modelling TSO-DSO coordination: The value of distributed flexible resources to the power system. I: 2019 16th International Conference on the European Energy Market - EEM 2019.** IEEE 2019 ISBN 978-1-7281-1257-2. p. 1-6. ENERGISINT NTNU
10. **Li, Chendan; Molinas Cabrera, Maria Marta; Fosso, Olav B; Qin, Nan; Zhu, Lin. A Data-driven Approach to Grid Impedance : Identification for Impedance-based Stability Analysis under Different Frequency Ranges. I: 2019 IEEE Milan PowerTech.** IEEE 2019 ISBN 978-1-5386-4722-6. NTNU
11. **Melby, Mathias; Fosso, Olav B; Molinas Cabrera, Maria Marta. Impact of Virtual Oscillator Control on the instantaneous properties of VSC output voltage in distorted island grids. I: Proceeding 45th Annual Conference of the IEEE Industrial Electronics Society - IECON 2019.** IEEE conference proceedings 2019 ISBN 978-1-7281-4878-6. NTNU
12. **Morch, Andrei Z; Sæle, Hanne; Siface, Dario; Migliavacca, Gianluigi; Gerard, Helena; Kockar, Ivana. Market architecture for TSO-DSO interaction in the context of European regulation. I: 2019 16th International Conference on the European Energy Market - EEM 2019.** IEEE 2019 ISBN 978-1-7281-1257-2. ENERGISINT

13. **Muka, Romina; Haugli, Fredrik Bakkevig; Vefsnmo, Hanne; Heegaard, Poul Einar. Information Inconsistencies in Smart Distribution Grids under Different Failure Causes modelled by Stochastic Activity Networks. I: 2019 AEIT International Annual Conference.** IEEE 2019 ISBN 978-8-8872-3745-0. p. 1-6 ENERGISINT NTNU
14. **Omerovic, Aida; Vefsnmo, Hanne; Erdogan, Gencer; Gjerde, Oddbjørn; Gramme, Eivind; Simonsen, Stig. A Feasibility Study of a Method for Identification and Modelling of Cybersecurity Risks in the Context of Smart Power Grids. I: COMPLEXIS 2019 - Proceedings of the 4th International Conference on Complexity, Future Information Systems and Risk 2019.** SciTePress 2019 ISBN 978-989-758-366-7. p. 39-51. ENERGISINT SINTEF
15. **Seijas Fernandez, Andres Antonio; Crespo del Granado, Pedro; Farahmand, Hossein; Rueda, Jose. Optimal battery systems designs for Distribution Grids: What size and location to invest in? I: 2019 International Conference on Smart Energy Systems and Technologies - SEST.** IEEE 2019 ISBN 978-1-7281-1156-8. p. 1-6. NTNU
16. **Zerihun, Tesfaye Amare; Garau, Michele; Helvik, Bjarne Emil. Dependability Modeling and Analysis of 5G Based Monitoring System in Distribution Grids. I: VALUE-TOOLS 2019 : Proceedings of the 12th EAI International Conference on Performance Evaluation Methodologies and Tools.** Association for Computing Machinery (ACM) 2019 ISBN 978-1-4503-6596-3. p. 163-166. NTNU

Peer-reviewed papers not in Cristin

1. Preventing DDoS with SDN in 5G, IEEE GLOBECOM Workshop on 5G wireless security, Mathias Kjølleberg Førland, Katina Kravevska, Michele Garau, and Danilo Gligoroski, 2019
2. Towards 5G Intrusion Detection Scenarios with OMNeT++, OMNeT++ Community Summit, Katina Kravevska, Michele Garau, Mathias Førland, and Danilo Gligoroski, 2019
3. An Industrial Trial of an Approach to Identification and Modelling of Cybersecurity Risks in the Context of Digital Secondary Substations, CRISIS 2019, Aida Omerovic,

Hanne Vefsnmo, Oddbjørn Gjerde, Siri T. Ravndal, Are Kvinnes-land, 2019

4. Single-phase synchronisation with Hilbert transformers: a linear and frequency independent orthogonal system generator, NORPIE 2019 - The Conference on Energy, Power Systems and Power- and Industrial Electronics, Sjur Føyen, Chen Zhang, Olav B. Fosso, Jon Are Suul, Takanori Isobe, 2019

Presentations

From: 2019 To: 2019 Main category: Conference lecture and academic presentation All publishing channels

1. **Abooshahab, Mohammad Ali; Hovd, Morten; Bitmead, Robert R. Disturbance and State Estimation in Partially Known Power Networks.** The 3rd IEEE Conference on Control Technology and Applications (CCTA 2019); 2019-08-19 - 2019-08-21. NTNU
2. **Fosso, Olav B. Cineldi - The Norwegian Research Centre for Intelligent Electricity Distribution (Smartgrid).** Smarter Grids and Storage in emerging energy ecosystems; 2019-01-07 - 2019-01-08. NTNU
3. **Fosso, Olav B. Renewable energy integration and role of storage in a distribution/microgrid environment. Expert Lecture At:** Indian Institute of Technology Delhi and Delhi Technological University, Delhi, India Affiliation: Indian Institute of Technology Delhi; 2019-01-09 - 2019-01-10. NTNU
4. **Kjølle, Gerd Hovin. CINELDI –innspill til pågående arbeid med gjennomgang av driftskoordinering i kraftsystemet.** NVE Seminar om Driftskoordineringen; 2019-10-23 - 2019-10-23 ENERGISINT
5. **Kjølle, Gerd Hovin. Fremtidens smarte energisystem.** Energidagen; 2019-10-31 - 2019-10-31. ENERGISINT



6. **Kjølle, Gerd Hovin.**
Hva står strømmettet overfor av utfordringer og utviklingsbehov fremover? Lunsjseminar; 2019-10-29 - 2019-10-29. ENERGISINT
7. **Kjølle, Gerd Hovin.**
Scenarier for fremtidens nett 2030-2040. Smartgrid-konferansen; 2019-09-10 - 2019-09-11. ENERGISINT
8. **Kjølle, Gerd Hovin; Moe, Marie.**
Cyber security i fremtidens intelligente distribusjonsnett. Workshop om cyber security i kraftnettet; 2019-08-22 - 2019-08-22. ENERGISINT
9. **Marafioti, Giancarlo; Sperstad, Iver Bakken.**
Methods for operation and sizing of flexible resources – a Model Predictive Control perspective. CINELDI WP5 Webinar; 2019-09-02 - 2019-09-02 SINTEF ENERGISINT
10. **Omerovic, Aida; Vefsnmo, Hanne; Erdogan, Gencer; Gjerde, Oddbjørn; Gramme, Eivind; Simonsen, Stig.**
A Feasibility Study of a Method for Identification and Modelling of Cybersecurity Risks in the Context of Smart Power Grids. COMPLEXIS 2019; 2019-05-02 - 2019-05-04. ENERGISINT SINTEF

Media contributions

From: 2019 To: 2019 Main category: Media contribution sub-category: Popular scientific article sub-category: Interview Journal sub-category: Article in business/trade/industry journal sub-category: Sound material All publishing channels

1. **Coldevin, Grete Håkonsen.**
Forskningen skal gi verdiøkning. Energiteknikk [Business/trade/industry journal] 2019-12-01. ENERGISINT
2. **Fjellså, Ingvild Firman.**
- Ikke like smart for alle. Energiteknikk bilag [Business/trade/industry journal] 2019-12-01. NTNU
3. **Fosso, Olav B.**
Elbilparken som "living laboratory". Energiteknikk [Business/trade/industry journal] 2019-12-01. NTNU
4. **Garau, Michele.**
5G øker funksjonaliteten. Energiteknikk [Business/trade/industry journal] 2019-12-01. NTNU

5. **Gjerde, Oddbjørn.**
Bedre digital nettplanlegging. Energiteknikk [Business/trade/industry journal] 2019-12-01. ENERGISINT
6. **Gjerde, Oddbjørn.**
Strømbruddet i Argentina kan felle presidenten og gi ny økonomisk krise. Aftenposten [Newspaper] 2019-06-18 ENERGISINT
7. **Göthner, Fredrik T. B. W.**
Mikronett gir bedre spenningskvalitet. Energiteknikk [Business/trade/industry journal] 2019-12-01. NTNU
8. **Kara, Güray.**
Nettet kan driftes bedre. Energiteknikk [Business/trade/industry journal] 2019-12-01. NTNU
9. **Kjølle, Gerd Hovin.**
Hafslund Nett fikk innovasjonspris. Energiteknikk [Business/trade/industry journal] 2019-09-10 ENERGISINT
10. **Kjølle, Gerd Hovin.**
Hafslund Nett får innovasjonspris. Europower Energi [Business/trade/industry journal] 2019-09-11 ENERGISINT
11. **Kjølle, Gerd Hovin.**
Har laget omlag 120 miniscenarier. Energiteknikk [Business/trade/industry journal] 2019-12-01 ENERGISINT
12. **Kjølle, Gerd Hovin.**
Hvordan kan vi få et smartere strømmett? TU [Business/trade/industry journal] 2019-06-25. ENERGISINT
13. **Kjølle, Gerd Hovin.**
I går våknet 48 millioner mennesker i Sør-Amerika opp uten strøm. Heiser stoppet og trafikkluss sluttet å fungere. Kan det samme skje i Norge, spør vi. NRK Radio [Radio] 2019-06-17. ENERGISINT
14. **Kjølle, Gerd Hovin.**
Mer kunnskap for et smartere nett. Energiteknikk [Business/trade/industry journal] 2019-12-01 ENERGISINT
15. **Kjølle, Gerd Hovin.**
Smarte distribusjonsnett vil gi store KILE-besparelser. Energiteknikk [Business/trade/industry journal] 2019-04-05. ENERGISINT

16. **Kjølle, Gerd Hovin.**
SMARTGRID KONFERANSEN 2019: DIGITALISERINGENS MULIGHETSROM. Sinus [Business/trade/industry journal] 2019-11-20. ENERGISINT
17. **Kjølle, Gerd Hovin.**
Tensio vil ruste strømmettet for fremtiden. <https://for-nybarklyngen.no/2019/tensio-vil-ruste-stromnettet> [Business/trade/industry journal] 2019-10-30 ENERGISINT
18. **Korpås, Magnus.**
Forsker på gode ladesystemer. Energiteknikk [Business/trade/industry journal] 2019-12-01. NTNU
19. **Moe, Marie Elisabeth Gaup.**
Lager treningsimulator for cyber-angrep. Energiteknikk [Business/trade/industry journal] 2019-12-01. NTNU
20. **Muka, Romina.**
Flere "øyne" på nettet. Energiteknikk [Business/trade/industry journal] 2019-12-01. NTNU
21. **Sand, Kjell.**
Unikt laboratorie-konsept. Energiteknikk [Business/trade/industry journal] 2019-12-01. NTNU
22. **Skjølsvold, Tomas Moe.**
"Smartgridutvikling" som samfunnsutvikling. *sosiologen.no* 2019. NTNU
23. **Skjølsvold, Tomas Moe.**
Smartgridutvikling som samfunnsutvikling. *#SINTEF-blog* 2019. NTNU
24. **Sæle, Hanne.**
Økt fleksibilitet i nettet er viktig. Energiteknikk [Business/trade/industry journal] 2019-12-01 ENERGISINT
25. **Taxt, Henning.**
Trener på framtidens nett. Energiteknikk [Business/trade/industry journal] 2019-12-01. ENERGISINT
26. **Thorvaldsen, Kasper Emil.**
Vil redde verden! Energiteknikk [Business/trade/industry journal] 2019-12-01. NTNU
27. **Torsæter, Bendik Nybakk.**
Bonde Lars Hoem skal bli sin egen energi-øy. TU [Business/trade/industry journal] 2019-09-01 ENERGISINT

28. **Torsæter, Bendik Nybakk.**
Fem spørsmål og svar om mikronett. TU [Business/trade/industry journal] 2019-12-26. ENERGISINT
29. **Torsæter, Bendik Nybakk.**
5 spørsmål om mikronett. TU [Business/trade/industry journal] 2019-11-19. ENERGISINT

Blogs and information material

From: 2019 To: 2019 Main category: Information material(s) All publishing channels

1. **Degefa, Merkebu Zenebe.**
How to estimate flexibility potential of household appliances? (To reduce peak load). ENERGISINT
2. **Farahmand, Hossein.**
Consumer and prosumer cooperation may equal reduced electricity prices. NTNU
3. **Foros, Jørn.**
Maskinlæring for bedre avbruddshåndtering i framtidens smartgrid. ENERGISINT
4. **Fuchs, Ida.**
Innovation on the agenda for CINELDI PhDs. NTNU
5. **Garau, Michele.**
Smart grid monitoring: new opportunities and challenges with digitalization and 5G integration. NTNU
6. **Göthner, Fredrik T. B. W.**
Mikronett: Hva er det, virtuell impedans og øydrift. ENERGISINT
7. **Göthner, Fredrik T. B. W.**
Microgrids: What are they, virtual impedance and a control concept for inverters in islanded microgrids. NTNU
8. **Hermansen, Tonje Skoglund.**
CINELDI presenterte forskning på CIRED konferansen. ENERGISINT
9. **Hermansen, Tonje Skoglund.**
En oppsummering fra CINELDI-konferansen 2019. ENERGISINT
10. **Hermansen, Tonje Skoglund.**
Finding Smart Grid driving forces and how they affect Smart Grid development. ENERGISINT

- 
11. **Hermansen, Tonje Skoglund.**
Registration open for CINELDI Conference: Future electricity distribution grid R&D. ENERGISINT
 12. **Kjølle, Gerd Hovin.**
CINELDI årsrapport. ENERGISINT
 13. **Sperstad, Iver Bakken.**
Keeping solar and wind energy stored in the battery: What is the value? ENERGISINT
 14. **Sperstad, Iver Bakken.**
Kva er verdien av å spare på sol- og vindenergien lagra i batteriet? ENERGISINT
 15. **Sæle, Hanne.**
Electric vehicles in Norway and the potential for demand response. ENERGISINT
 16. **Sæle, Hanne.**
Elektriske biler i Norge og potensialet for forbruker-fleksibilitet. ENERGISINT
 17. **Taxt, Henning.**
Ekspertar fra Europas fremste smartgrid laboratorier møttes i Trondheim. ENERGISINT

Multimedia products

*From: 2019 To: 2019 sub-category: Multimedia product
All publishing channels*

1. **Kjølle, Gerd Hovin.**
CINELDI Annual Report 2018 video. SINTEF Energi 2019
ENERGISINT
2. **Kjølle, Gerd Hovin.**
Effektstudien. SINTEF Energi 2019. ENERGISINT
3. **Kjølle, Gerd Hovin.**
Pilotprosjekter i CINELDI. SINTEF Energi - CINELDI 2019
ENERGISINT
4. **Steenstrup-Duch, Anne.**
CINELDI og Skagerak Energilab. SINTEF Energi - CINELDI
2019. ENERGISINT
5. **Sæle, Hanne.**
SINTEF - Hanne Sæle. enerWe Vimeo 2019. ENERGISINT
6. **Vefsnmo, Hanne.**
CINELDI selvhelende strømnnett. SINTEF Energi - CINELDI
2019. ENERGISINT
7. **Vefsnmo, Hanne; Kjølle, Gerd Hovin.**
Self-healing distribution Grids. SINTEF Energi - CINELDI
2019. ENERGISINT

Read our digital annual report for
videos and more www.cineldi.no
-> Annual report 2019



The Research Council of Norway

CINELDI – Centre for intelligent electricity distribution

CINELDI is a Centre for Environment-friendly Energy Research (FME).

The objective of the FME-scheme is to establish time-limited research centres which conduct concentrated, focused and long-term research of high international calibre.

Contacts:

Centre Director Gerd Kjølle • Gerd.Kjolle@sintef.no

Administrative Coordinator Hanne Sæle • Hanne.Saele@sintef.no

Project Manager Tonje Skoglund Hermansen • tonje.skoglund.hermansen@sintef.no