



Development and analysis of hourly DHW heat use profiles in nursing homes in Norway

Dmytro Ivanko^{a,*}, Harald Taxt Walnum^b, Natasa Nord^a

^a Department of Energy and Process Technology, Norwegian University of Science and Technology (NTNU), Kolbjørn Hejes vei 1 B, Trondheim 7491, Norway

^b SINTEF Community, P.O. Box 124 Blindern, 0314 Oslo, Norway

ARTICLE INFO

Article history:

Received 26 November 2019

Revised 3 March 2020

Accepted 13 April 2020

Available online 8 May 2020

Keywords:

DHW heat use

Energy efficiency

Hourly profiles

Mathematical modelling

Statistical analysis

ABSTRACT

Representative profiles for domestic hot water (DHW) heat use are the main instruments for improvement in operation and design of DHW systems in buildings. To improve the existing method for DHW heat use profiles development and analysis, investigations in the three nursing homes in Norway were conducted. Statistical methods to assess the similarities of the profiles by days of the week and seasons were proposed. The analysis allowed us to identify two seasons of DHW heat use: the warm season from June to October, and the cold season including the rest of the year. In addition, it was investigated that the DHW heat use in the working days was significantly different from the weekends. According to these results, unified profiles for the months and days of the week with similar characteristics of the DHW heat use were developed. After, the method for statistical grouping of the DHW hourly heat use was applied to recognize the timing of the peak, average, and low heat use. Finally, the profiles for the DHW heat use obtained for the nursing homes were compared with profiles in the national and international standards. The drawbacks of the standards were identified.

© 2020 The Authors. Published by Elsevier B.V.

This is an open access article under the CC BY license. (<http://creativecommons.org/licenses/by/4.0/>)

1. Introduction

Nowadays, energy efficiency and decarbonisation are the key driving forces in the development of European Union (EU) energy industry. Among all sectors, buildings sector is one of the most energy-intensive. The Energy Performance of Buildings Directive (EPBD) estimates the share of energy use in building as 40% from the total energy use in the EU [1]. Considering the huge potential of energy saving in buildings, European Commission (EC) develop a set of long-term and short-term goals for increasing energy efficiency in buildings [2]. For example, by 2020 all new buildings should be constructed in accordance with zero emission standards, and at least 3% of the total floor area of governmental buildings should be renovated [1]. The energy infrastructure in buildings that were built 30–40 years ago needs to be replaced by more energy efficient [3]. According to Energy roadmap 2050 [3], the goal to reduce CO₂ emission to 80–95%, when compared to 1990 level, by 2050 scenarios is set [3]. To achieve this goal, all technical systems in buildings must be designed and operated in such a way as to ensure efficient energy use.

Until recently, in many European countries, including Norway, a lot of effort has been put on the investigation of the performance of the space heating systems [4]. Meanwhile, the DHW heat use was considered as a small part of the energy needs required for heating. Therefore, DHW heat use has obtained little focus, especially in countries with cold climate [5]. However, with introduction of passive house technologies and improvement of building envelope, the space heating heat use in buildings is constantly decreasing. At the same time, reduction of DHW heat use remains insignificant [6]. For example, the experience from design of low energy buildings in Denmark is shared in [7]. In this study, to achieve low heat use, passive building strategies with highly insulated, resource efficient, and airtight solution are used, without focusing on DHW use. The authors in [7] conclude that detailed design values for the passive building show that energy demand for the DHW use is almost twice bigger than space heating. The analysis of energy use in four apartment buildings in Finland with various construction years is performed in [8]. In this study, to assess DHW heat use, the profiles obtained from measured DHW demand in apartment buildings are used as input in IDA-ICE simulation software. Simulation shows that in the modern buildings, the domestic hot water is the most significant component in heat use. In two buildings constructed before 2002, the DHW heat use contributes 24% and 30% to the total energy use in the buildings. However, in

* Corresponding author. Phone number: (+47) 48670338
E-mail address: dmytro.ivanko@ntnu.no (D. Ivanko).

two well-insulated buildings, the DHW systems is responsible for 52% and 63% of the total energy use. As we can see, the share of the DHW energy use tends to increase from approximately 20% in regular buildings [5] to above 50% in passive houses and well-insulated buildings [9]. Consequently, heat use for DHW systems is becoming the critical component for energy saving, especially in passive houses and nearly zero energy buildings (NZEB) [10].

Nowadays, heat losses from the hot water tanks and the circulation systems in houses, schools, and other institutions remain high [11]. As a result, further energy saving measures in buildings should shift the focus from improving space heating to improve DHW systems. To realize potential of energy savings in DHW systems, the research and innovations in the field of DHW energy performance becoming increasingly relevant and valuable [9].

It should be noted that the operation of the DHW systems is associated with sanitary and health safety issues. These issues for different types of buildings is discussed in [12]. Appearance of Legionella bacterium in DHW systems is a serious problem. Legionella bacterium can lead to different forms of pneumonia and even death. The conditions for Legionella spreading are water temperatures from 25°C to 42°C, nutrients, and stagnating water. Therefore, many countries, including Norway, develop regulations to minimize the risk of Legionella disease appearance. For example, despite of energy ineffectiveness, to prevent risks of the bacteria growth, the DHW systems in Norway store and distribute hot water at temperatures above 60°C. Among all buildings, special attention is paid to the nursing homes, because the elderly, who usually have respiratory problems and weakened immune system, are heavily affected by this bacterium. The safety of energy effective solutions is the key factor in DHW systems.

The share of DHW heat use is varying from country to country and one type of building to another [5]. For example, specific DHW heat use in households in different EU countries are significantly varying as shown in [13]. Comprehensive comparison of DHW energy use in residential buildings in Denmark, Norway, and Sweden is performed in nineties [14]. Even though that study is somewhat outdated, it describes well the general trends in the DHW use in these countries. Sweden, Norway, and Denmark share a similar living standard, comparable patterns of household formation, and a similar climate. Nevertheless, the DHW heat use in Denmark is significantly below those in Sweden and Norway. In addition, the authors conclude that national average, electricity use per capita for the DHW heating in Norway has almost not changed for 15 year, and remains high when compared with other countries within The Organization for Economic Cooperation and Development (OECD). The authors explain this phenomenon by difference in occupants' behaviour and the insulation of DHW systems in different countries. More recent research confirms this statement [15] and it shows that the average individual DHW use reaches 40 L/person/day in Norway, while in Denmark, the average value is at 20 L/person/day [15].

For the sake of simplification, many methods propose to consider the DHW use as a constant value for calculations [16]. Practical experience shows that the commonly used standards are based on assumptions for the DHW heat use in the buildings, but these standards do not correspond to the real use [17]. For example, simplified, but meantime common way of DHW system performance simulations is shown in [18]. Further, DHW system performance are simulated based on daily water need as a constant value of 90 l/day per bedroom and with 25 K temperature difference between supply and return in [18]. Such simplifications could lead to oversizing of the components for DHW systems and additional financial and energy losses [19].

DHW heat use profiles are the primary instrument for estimating the DHW heat use in the buildings [5]. Analysis of DHW heat use profiles shows the changes in heat use in different time inter-

vals [20]. The profiles of DHW heat use allow us to determine the hours of peak energy loads and other energy load characteristics of the building.

Performance of DHW systems is a complex and multidisciplinary issue. It includes economic, sanitary, behavioral, and technical areas. DHW heat use profiles is a useful for identifying energy efficient solutions within all these areas. For example, the economic analysis of DHW pricing is performed in [21]. The study shows that the DHW use positively correlated with income and reacts to the changes in water prices. Introduction of new energy or heat tariffs is a way of reducing the DHW use in buildings. However, in order to implement advanced and flexible energy or heat tariffs, the in-depth knowledge about profiles of DHW use is required. Technical solutions dealing with sanitary problems are considered in [22]. Some of these solutions require knowledge of the profiles and timing when DHW water is used. Different types of DHW heating systems are investigated in [23]. This study summarises that DHW energy use can be reduced through using combined systems based on traditional and renewable energy solutions. However, due to unstable behaviour of renewable energy sources, development of accurate profile and prediction of DHW heat use becoming crucial for successful operation of combined DHW heating systems. Most of building simulation software tools such as IDA ICE, EnergyPlus, TRNSYS, TRANSOL, etc. require DHW profiles as the basis for simulation of DHW systems performance in buildings [5]. For example, it is noted that the variations between the simulated and the real heat use for DHW are caused by inappropriate profiles [24]. Consequently, the authors in [24] claim that input data for DHW volume flow rates used in the standards represent perhaps one of the more critical points in simulation models. Therefore, actual knowledge of DHW usage profiles can capture the real heat use in buildings, making it possible to size systems properly. Effective demand-side management, energy conservation measures, improvement of legislation and standards require accurate DHW profiles for different types of buildings [25]. As we can see, scientific and practical work confirms the need to use profiles of the DHW heat use to solve important issues in the DHW systems.

The issue of DHW heat use analyses in buildings based on profiles is investigated by researchers in Norway and abroad [5]. However, due to differences in particular characteristic of each buildings, quality of available data, and calculation requirements, there is no unique method of performing appropriate analysis. The number of scientific works is dedicated to the issue of DHW energy profiles development and analysis. For example, hourly DHW profiles for five groups of buildings with 1, 3, 10, 31, and 50 residents are developed based on data from Finnish apartments in [26]. Further, the profiles for each group with the closest to mean profile and have a similar shape, are selected among measured candidates as representative. The volumetric flow rates, cold and supply temperatures are measured to characterise the DHW use in 20 buildings of different sizes in [27]. Based on the obtained data, the authors executed several stochastic simulations to get a representative DHW use profiles for end users [27]. Number of methods for DHW profiles development are based on operating schedules for the primary DHW energy users (showers, baths, sinks, dishwasher, and clothes washer) and occupant activities. As an illustration, the Building America House Simulation Protocols document provides guidance for such analysis in new and existing apartment buildings [28]. Lombardi in [29] shows that domestic water use can be presented as the result of probabilistic use of domestic appliances, each one with its particular characteristics. The research of Good and Zhang in [30] share the experience of calculation for DHW heat use profiles based on occupant activities. The DHW modelling approach by the coupling of behavioural activities, energy balance models, and stochastic modelling is presented in [31]. Time-use

data of activities in households in Sweden are used for generating DHW profiles in [32]. For DHW energy analysis, the occupant behaviour, appliance ownership, demographic conditions, and occupancy rate are considered in neural network model in [33]. Most of the reviewed research work are dedicated to the apartments and households, meaning that required parameters were easier to obtain. However, in non-residential buildings obtaining in-depth knowledge about occupant activities and equipment operation become time consuming and expensive task [5]. The available input data limits the practical application of these methods.

The problem of validation of DHW simulated profiles in non-residential buildings is proposed in [34]. For simulation, the authors use SIMDEUM in [35], which is based on the design rules for appliance performance and dominant variables in buildings. It is assumed that the dominant variable for hotels is the number of rooms, for offices is the number of employees, and for nursing homes is the number of beds [36]. The validation procedure consists of two steps. In the first step, the outcome of simulation is compared with measured demand values. In the next step, it is proposed to check if the assumptions on the standardized building based on the design rules are validated with measurements and surveys [34]. This study shows that it is challenging to find information of users and appliances in each functional room to equip the standardised buildings. However, regular demand pattern for dominant functional room can be obtained.

The problems of comparing the actual DHW energy use profiles with the standards, and their verification, are also not going unnoticed. For example, the comparison of the actual DHW profiles in apartments with profile proposed by American Society of Heating, Refrigeration and Air Conditioning Engineers (ASHRAE) is conducted in [37]. The research shows that the primary difference between the actual and the ASHRAE derived data is that the water use is less evenly distributed in the actual data, and there are higher peaks and lower troughs and much less use in the early morning hours in the actual data. Differences in shapes and parameters of the actual DHW heat use profiles for particular types of buildings and profiles represented in publications and standards are considered in [38]. As a conclusion, in this work, the authors recommend to rely on actual profiles obtained from measurement systems for the analysis of DHW use in the existing buildings.

The aim of our paper was to improve the existing approaches for the DHW heat use analysis and gain in-depth knowledge about it in nursing homes in Norway. Non-residential buildings such as nursing home, hospitals, hostels, schools, etc. in Norway and other European countries are less studied than residential [5]. The knowledge about actual DHW heat use profiles in nursing homes in Norwegian is currently incomplete and contain many gaps. The study in [39] shows that the specific heat use in the hospitals and nursing homes in Norway is approximately 270 kWh/m² per year, and one of the highest comparing to other types of buildings. Quite often, profiles presented in standards for nursing homes cannot represent the actual DHW heat use [39]. For this reason, the investigation on the DHW heat use in nursing homes in Norway is required. Such a study is the basis for the further introduction of energy saving in nursing homes in Norway.

In this article, we presented the methods for developing and analysing profiles for DHW heat use. The proposed methods allow us to assess the similarities of the profiles by days of the week and seasons, and identify the timing of the peak heat use of the DHW system. The methods were tested based on one-year hourly measurements from three nursing homes, located in Eastern Norway. The unified profiles for the months and days of the week with similar characteristics of the DHW heat use were identified. For these profiles the timing of the peak, average, and low heat use was estimated. The profiles obtained from measurements were compared with profiles from the national standard SN/TS 3031:2016 [41] and

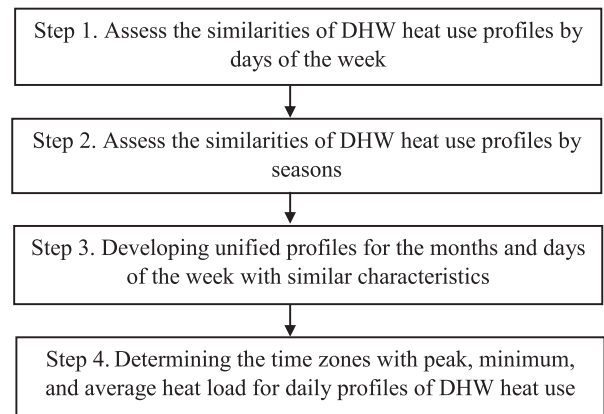

Fig. 1. Method for the analysis of DHW heat use profiles.

international standard NS-EN 12831-3:2017 [42]. The possible benefits from using more accurate energy profiles, obtained by measurements and statistical analysis, are explained in this study.

The paper was organised as the following. Section 2 introduced the method for developing profiles, divided by days of the week and seasons with similar characteristics of the DHW heat use. In this section, the method for determining the peak, average, and low zones of the DHW heat use from the profiles was also presented. Section 3 explained the main characteristics of DHW system for the case study - three nursing homes located in eastern Norway. In Section 4, the method was implemented on the real data. The obtained profiles for the nursing homes were analysed and compared with the profiles of DHW heat use given in the standards. The main results of this investigation were presented. Finally, the main conclusions of the study were emphasized in Section 5.

2. Method

The method for the analysis of DHW profiles included the four main steps shown in Fig. 1.

The three following subsections covers the methods that were used to solve issues in shown Fig. 1. Section 2.1 described the method for comparison of the DHW heat use profiles from different days of the week and assessing their similarities. In this study, we did not assume, beforehand that the profiles can be divided in a certain way. Student's t-test and Fisher's exact test were used for solving this issue. By using this method, the data tests may be used for samples with standard normal distribution and t-distribution. This allowed to us to determine the statistically justified days of the week with similar DHW heat use profiles. In Section 2.2, a method for determining the duration and boundaries of time zones with peak, minimum, and average heat use during the day was showed. In Section 2.3, a statistical method for identifying the number of seasons, as well as the months included in each season was described. By using this method, the impact of seasonality on DHW heat use was taken into account.

2.1. Comparing similarity of DHW heat use profiles in different days of the week

To determine the days of the week with similar characteristics of DHW heat use, a method based on test statistics was proposed. The similarity of two DHW heat use profiles is checked based on the Student's t-test and Fisher's exact test. Appropriate tests can be used for samples with standard normal distribution and t-distribution.

By applying the Student's t-test, it was possible to check if the mean values of DHW heat use from two days of the week were equal or not. To achieve this, the DHW heat use within each day was considered as a statistical sample with 24 elements, which represented the number of hours in the day. The t-test statistical value was calculated as follows:

$$T_{cal} = \frac{\bar{E}_{prof1} - \bar{E}_{prof2}}{\sqrt{\frac{S_{prof1}^2}{n_{prof1}} + \frac{S_{prof2}^2}{n_{prof2}}}} \quad (1)$$

where \bar{E}_{prof1} , \bar{E}_{prof2} were the mean values of the DHW heat use in the first and second samples. S_{prof1} , S_{prof2} were the standard deviations of the DHW heat use profiles in the first and second samples. n_{prof1} , n_{prof2} were the number of elements in the first and second samples. Finally, the equation for the standard deviation for i -th day was written as:

$$S_{prof i} = \sqrt{\frac{\sum (E_{prof i,j} - \bar{E}_{prof i})^2}{n_{prof i} - 1}} \quad (2)$$

where i was the number of the sample, j was the number of element in the sample, $E_{prof i,j}$ was the DHW heat use in j -th element in i -th sample.

The obtained value for t-criteria, T_{cal} , was compared with the critical value, T_{cr} . T_{cr} may be found in literature for different degrees of freedom and significance level k . The comparison may lead to three possible situations as the following:

- If $T_{cal} \leq T_{cr}(n_{prof1} + n_{prof2} - 2, k = 0.05)$, then the mean values of the first and the second samples are similar;
- If $T_{cal} \geq T_{cr}(n_{prof1} + n_{prof2} - 2, k = 0.01)$, then the mean values of the first and the second samples have a significant difference;
- If $T_{cal} \leq T_{cr}(n_{prof1} + n_{prof2} - 2, k = 0.01)$ and $T_{cal} \geq T_{cr}(n_{prof1} + n_{prof2} - 2, k = 0.05)$, then the mean values of the first and the second samples may be considered as similar. However, the final decision should be done based on the knowledge of researchers.

Meanwhile, Fisher's criterion allowed us to estimate the similarity of two samples by variances:

$$f_{cal} = \frac{\max(S_{prof1}^2, S_{prof2}^2)}{\min(S_{prof1}^2, S_{prof2}^2)} \quad (3)$$

The comparison obtained by calculations of the Fisher criterion, f_{cal} with its critical value, f_{cr} led to the following results:

- If $f_{cal} \leq f_{cr}(n_{prof1} + n_{prof2} - 2, k = 0.05)$, then the variances of the first and the second samples are similar;
- If $f_{cal} > f_{cr}(n_{prof1} + n_{prof2} - 2, k = 0.05)$, then the variances of the first and the second samples have significant difference.

The two profiles are considered to be similar if both Student's t-test and Fisher's exact test show the same results. If at least one of two tests shows that the mean values or variances of profiles in the first and the second samples are not similar, it is possible to conclude that the profiles are dissimilar and should be analysed separately.

Splitting the DHW profiles by the days of the week should be made based on a large dataset, which represents DHW heat use during the year. Therefore, in this study, it was proposed to divide initial statistical data into separate weeks. Within each week, all combinations of the daily DHW profiles should be compared among themselves by Student's t-test and Fisher exact test. For instance, profiles for Monday and Thursday, Monday and Wednesday, Saturday and Sunday and so on should be compared. Afterwards, for all the combinations of days, the number of the weeks can be

Table 1
The form of the matrix of matches.

	Mo.	Tu.	We.	Thu.	Fr.	Sa.	Su.
Mo.	$n_{1,1}$	–	–	–	–	–	–
Tu.	$n_{2,1}$	$n_{2,2}$	–	–	–	–	–
We.	$n_{3,1}$	$n_{3,2}$	$n_{3,3}$	–	–	–	–
Th.	$n_{4,1}$	$n_{4,2}$	$n_{4,3}$	$n_{4,4}$	–	–	–
Fr.	$n_{5,1}$	$n_{5,2}$	$n_{5,3}$	$n_{5,4}$	$n_{5,5}$	–	–
Sa.	$n_{6,1}$	$n_{6,2}$	$n_{6,3}$	$n_{6,4}$	$n_{6,5}$	$n_{6,6}$	–
Su.	$n_{7,1}$	$n_{7,2}$	$n_{7,3}$	$n_{7,4}$	$n_{7,5}$	$n_{7,6}$	$n_{7,7}$

identified, when statistical tests show that profiles in considered pairs of days are similar. For further analysis, for each combinations of days of the week, the number of matches of the DHW profiles in percentage can be found as:

$$n_{i,j} = N_{i,j} \cdot 100/N_{total} \quad (4)$$

The elements in Equation (4) are the following, $n_{i,j}$ is number of matches in percentage, when the DHW profiles of i -th and j -th days were similar. $N_{i,j}$ was the number of the weeks, when statistical tests showed that the i -th and j -th days were similar. N_{total} was the total number of the weeks in the statistical data sample of DHW heat use. i was the day of the week of the first comparable profile (from 1 to 7). j was the day of the week of the second comparable profile (from 1 to 7). For better clarity, the results could be presented in the form of matrix of the matches as in Table 1.

Based on the matrix of matches, the groups of the days of the week with similar profiles of DHW heat use could be identified. Namely, the days of the week, which have $n_{i,j} \geq 100 - error$, have similar characteristics of DHW heat use and should be placed in one group and analysed together. The value of the error included the accuracy of Student's t-test, Fisher's exact test, and the percentage of days in the year when the building is not in operation in typical regimes such as holidays.

2.2. Determining the time zones with peak, minimum, and average heat load for daily profiles of DHW heat use

To implement energy management in buildings, it is essential to identify the typical duration and boundaries of time zones with peak load, minimum, and average heat load during the day. To solve this issue, we proposed to perform statistical grouping of the hourly heat use of the DHW system based on the method presented by Nakhodov in [40]. Initially, this method is used for identification of the tariff zones of electricity energy use in the power system. In this article, we adapted the method for analysis of DHW heat use in buildings. The method allowed us to divide the hours of DHW heat use into several groups with statistically different mean values within each group. It is based on an iteration procedure and analysis of the mean values of DHW heat use by applying Student's t-test. In this case, DHW heat use profile was considered as a statistical sample e . The sample contained $N=24$ elements (hours) with DHW heat use in these hours equal e_j (where e_j was DHW heat use in the j -th hour. j was the number of the element in the sample). The flowchart for the algorithm for determining the time zones with peak, minimum, and average heat load for daily profiles of DHW heat use is shown in Fig. 2.

The detailed algorithm of the method for determining the time zones was as the following:

Step 1. Sorting the elements of the sample in the order of their increase

The elements e_j in the sample e were sorted in the order of their increase. Such an arrangement of elements from smaller values of hourly DHW heat use to bigger values allowed us to obtain

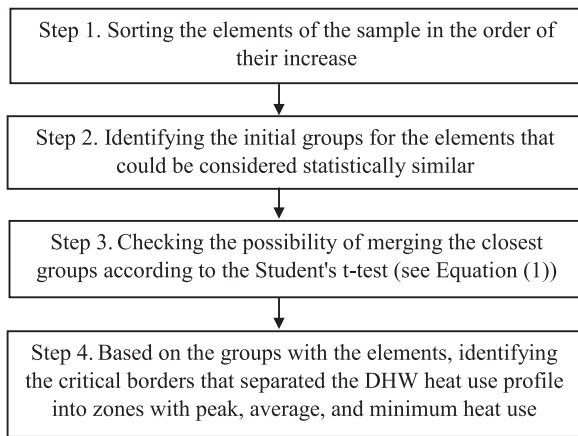

Fig. 2. Flowchart for the algorithm for determining the time zones with peak, minimum, and average heat load for daily profiles of DHW heat use.

the sorted sample E with N elements E_i (where $E_{i+1} > E_i$, i is the number of element in sample E).

Step 2. Identifying the initial groups for the elements that could be considered statistically similar

Based on the sample E , an iterative procedure of generating of two statistical subsamples R_1 and R_2 with variable number of elements was applied. For each step of iteration, sample R_1 contained M elements, while R_2 should have $M+1$ elements. The elements in samples R_1 and R_2 were taken consistently from the initial sample E . With each iteration, the number of elements M in these subsamples increased by one. The value of M varied from 1 to 23.

For each step of these iterations the value of Student's t -test for two subsamples R_1 and R_2 were calculated by using Equation (1).

For instance: iteration 1) $R_1 = [E_1]$, $R_2 = [E_1, E_2]$, $M=1$, and T_{cal1} ; iteration 2) $R_1 = [E_1, E_2]$, $R_2 = [E_1, E_2, E_3]$, $M=2$, and T_{cal2} ;... iteration 23) $R_1 = [E_1, E_2 \dots E_{23}]$, $R_2 = [E_1, E_2 \dots E_{24}]$, $M=23$, and T_{cal23} ;

Step 3. Checking the possibility of merging the closest groups according to Student's t -test

Based on the iteration procedure of Step 2, the series of t -criteria for all the combinations of the subsamples R_1 and R_2 , $T_{cal} = [T_{cal1}, T_{cal2} \dots T_M]$ were found.

If an ordered sample of hourly DHW heat use was monotonous, then the numerical values of elements in this sample increase evenly. In that case, the series of t -criteria obtained by iteration procedure would also be monotonous. This means that the values of t -criteria obtained by Equation (1) would decrease monotonically with each next iteration ($T_{cal1} > T_{cal2} \dots > T_M$). If the ordered sample of hourly DHW heat use was uneven, then a monotonic decrease of the calculated values of the t -criteria would be violated by periodic abrupt growth ($T_{cali} < T_{cali+1}$). Thus, the identification of points of growth of the calculated values of the t -criteria allowed us to determine between which hours there is a noticeable statistical difference of DHW heat use. This assumption allowed us initially to divide hours in the profile of DHW heat use into several groups. Each of these groups was the sample of data, where DHW heat use data varied monotonously. Created in this way, neighbouring groups of hourly DHW heat use could be checked in terms of the possibility for their further merge. For this purpose, the data samples of two neighbouring groups were assessed by Student's t -test (see Equation (1)). As a result, the calculated value of the t -criteria, T_{cal} , could be compared with critical value, T_{cr} . This comparison could lead to the three possible situations:

- If $T_{cal} \leq T_{cr}(n_{group1} + n_{group2} - 2, k = 0.05)$, then the mean values of the two groups were similar and should be merged;
- If $T_{cal} \geq T_{cr}(n_{group1} + n_{group2} - 2, k = 0.01)$, then the mean values of the two groups were different and they should be considered separately;
- If $T_{cal} \leq T_{cr}(n_{group1} + n_{group2} - 2, k = 0.01)$ and $T_{cal} \geq T_{cr}(n_{group1} + n_{group2} - 2, k = 0.05)$, then the mean values of the two groups could be considered as similar. However, the final decision should be done based on the knowledge of researcher.

After we merged the groups based on explained above conditions, the new set of groups was created. The calculations of Step 3 should be repeated from the beginning with the new set of groups in the sample. Iterative calculations of Step 3 was continued until the t -test showed that no groups can be merged together and that the total number of groups could not be reduced.

Step 1. Based on the groups with the elements, identifying the critical borders that separated the DHW heat use profile into zones with peak, average, and minimum heat use

Critical borders that separated the DHW heat use profile into zones with peak, average, and minimum heat use can be identified by the following:

$$E_{min} = \bar{E}_{group.1} + T_{cr.1}(M_{group.1} + 1 - 2, k = 0.01) \sqrt{\frac{S_{group.1}^2}{M_{group.1}}} \quad (5)$$

$$E_{max} = \bar{E}_{group.K-1} + T_{cr.K-1}(M_{group.K-1} + 1 - 2, k = 0.01) \sqrt{\frac{S_{group.K-1}^2}{M_{group.K-1}}} \quad (6)$$

where $\bar{E}_{group.1}$, $\bar{E}_{group.K-1}$ were the mean values of the DHW heat use in the first group and the next to the last group. $M_{group.1}$, $M_{group.K-1}$ were the numbers of the elements in the first group and the next to the last group. $S_{group.1}^2$, $S_{group.K-1}^2$ were the standard deviations in the first group and the next to the last group. $T_{cr.1}$, $T_{cr.K-1}$ were the critical values of the t -criteria for the first group and the next to the last group. The hours in which the DHW heat use was below E_{min} should be considered as zone with the minimum DHW heat use. If the DHW heat use was between E_{min} and E_{max} , it could be assumed that in these hours the DHW heat use was in a zone of average heat use. The hours with the DHW heat use higher than E_{max} lied within the zone of the maximum heat use.

2.3. Determining the seasons of DHW heat use

The method described in Section 2.2 can be applied in order to identify the groups of months with similar characteristics of the DHW heat use. In this case, in contrast to the sample of 24 hours for each daily profile as considered in Section 2.2, the initial sample contains 12 elements for the monthly DHW heat use during the year. The basic principles and procedure of calculations in both hourly and monthly analysis was the same. As a result, the number of seasons of the DHW heat use in the year and the months included in each season could be identified.

3. Description of buildings

One year of hourly measured data for the DHW heat use were collected from three nursing homes located in the Eastern Norway. The characteristics and work regimes of the nursing homes were typical for Norwegian conditions and was expected to be representative for DHW heat use in the similar types of buildings.

Table 2
Main properties of measured nursing homes.

ID	Area [m ²]	Number of rooms	Heat source	Distribution heating	Storage	Measurement
NH1	3 327	52	Electric water heaters 3 × 25 kW	Electric heat tracing	3 × 600 liter	Electricity energy to water heaters
NH2	2 609	25	Electric water heaters 2 × 25 kW	Electric heat tracing	2 × 900 liter	Electric energy to water heaters
NH3	6 774	50	Local area heating + electric water heaters 3 × 15 kW	Circulation (short-circuited)	3 × 400 liter	Electric energy to water heater and thermal energy from district heating

Table 2 shows the main properties of the observed buildings, and Fig. 3 shows the principle layout of the DHW plants, including the measurement points. The energy meters are marked with EM in Fig. 3.

For all the buildings, the measured heat use was the total heat delivered into the system, i.e. including the heat losses. The two buildings, NH1 and NH2 did not have hot water circulation systems, but electric heat traces. The power use of the heat tracers were not included in the measurements, which means that the distribution losses were not accounted. The third building, NH3, had a circulation system, but the system was short-circuited close to the heating plant, which means that the thermal losses in the circulation were minimal. Based on this, it was assumed that the measured heat use for the DHW in all the buildings were without distribution losses, and thereby compared on equal ground.

The main differences between the nursing homes was the room density (the total area per room), with a range from 64 to 136 m²/room. All nursing homes have private rooms only, all with the individual bathrooms, and the nursing homes are normally fully occupied. Therefore, the number of rooms was also representative for the amount of people living in the buildings. For investigation, the weather data obtained from the closest weather station were used.

4. Results and Analysis

The section is divided in several subsections that consider specific steps of the method explained in Section 2. The analysis of the variation of DHW heat use in the nursing homes, as well as the indicators that explains its variability, was shown in Section 4.1. Section 4.2 investigates the nursing homes DHW heat use profiles aggregated by similar days of the weeks and seasons. The hours of peak, average and minimum heat use for these profiles were studied. In Section 4.3, the standards were compared with the profiles obtained from the measurements. The drawbacks of the standards were highlighted.

4.1. Initial analysis of DHW heat use in the nursing homes

Even within the same building type, the characteristics of heat use may vary. To compare buildings with different characteristics, specific heat use may be used. Specific heat use is actual heat use of the building divided by certain physical indicator. This indicator explains variability of the DHW heat use in different buildings, and makes them comparable with each other. For this purpose in buildings, the specific heat use per number of rooms or area is commonly used. To choose which of these indicators to use in further analysis, the box plots of daily heat use were analysed as shown in Fig. 4.

The results in Fig. 4 show that the relative difference in the average daily use is 67 % per area and 41% per room. Since the main reason for DHW use at nursing homes are related to hygienic purposes and nourishment of the residents, it is reasonable to think that the number of rooms is better parameter for describing the DHW heat use. Accordingly, in the further analysis, attention will be paid mainly to the specific energy use per room. Only in the parts of the article dedicated to the standards, where it is relevant, the heat use per m² also will be considered. The DHW heat use per room is quite high (see Fig. 4 b)) since rooms in the nursing homes have large area from 64 to 136 m²/room.

The nursing homes considered in the article had similar trends and regimes of the DHW heat use. The difference in variance in their DHW heat use was within 30%. The energy distance test [41] showed that distributions of the DHW heat use in nursing homes were identical and it provided a foundation for further statistical analysis. Therefore, in order to simplify analysis and make

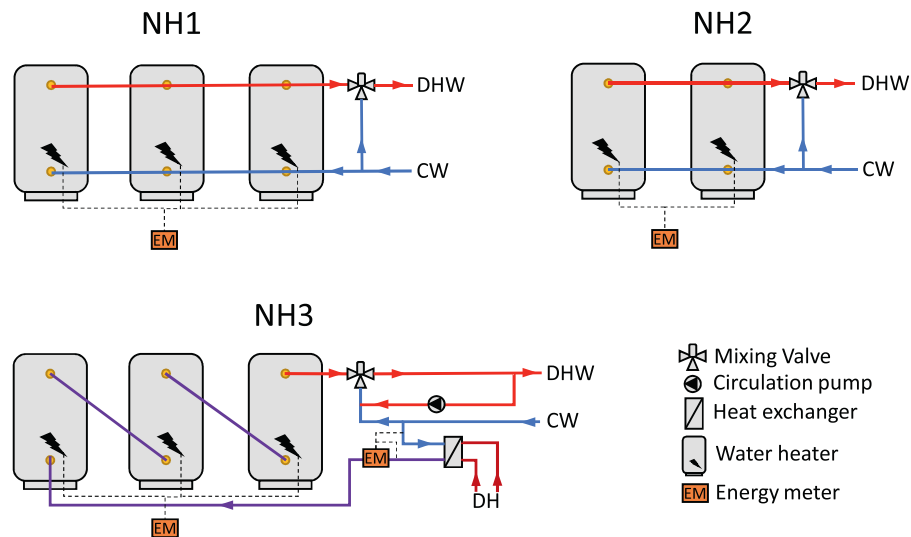

Fig. 3. Principle layout of the three DHW plants.

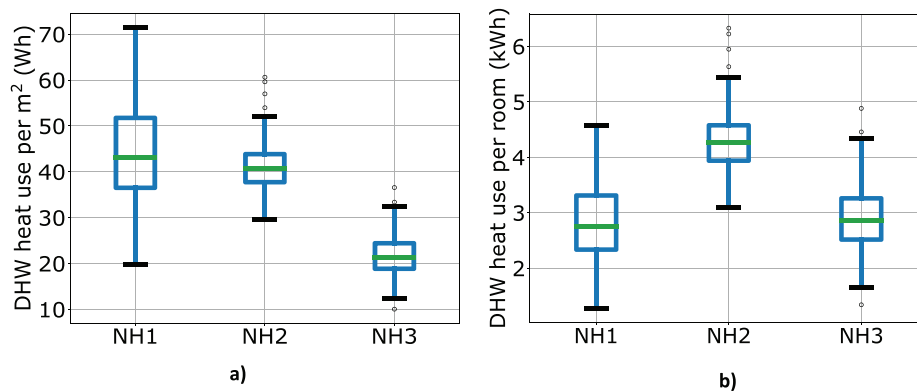

Fig. 4. Box plot of daily DHW heat use in the nursing homes, where: a) DHW heat use per m², b) DHW heat use per room.

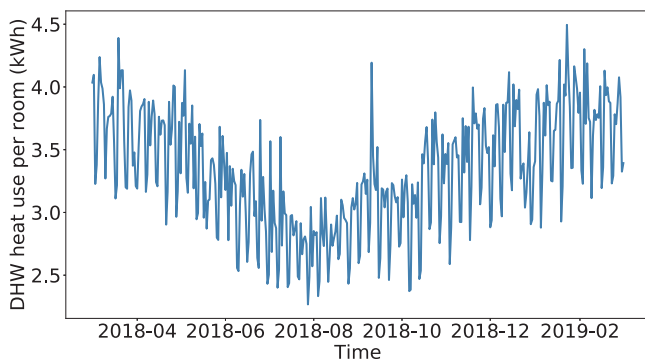

Fig. 5. Average hourly DHW heat use in three nursing homes.

the results more representative, the average DHW heat use of the three nursing homes was investigated. One-year data of the average specific DHW heat use for the three nursing homes are shown in Fig. 5.

From Fig. 5 it can be noted that the DHW heat use during the year were varying, and seasonal influence was clearly present. Seasonality of the DHW heat use will be explained in detail in Section 4.2. In addition, some spikes may be noted in the data, for example on September 9th, 2018 at 24:00 o'clock. These spikes showed untypical behaviour of the DHW heat use. Untypical spikes

where taken into account in the analysis of DHW heat use. Another point that was taken into account in the analysis was the difference in behaviour on holidays compared to ordinary days. Fig. 6 shows the DHW heat use in the nursing homes in the week without holidays (from January 1st to January 13th), the week that contained Christmas holidays (from December 24th to December 30th), and days which are official public holidays (from December 25th to 26th December, and January 1st).

As we can see from Fig. 6, the shapes of the DHW heat use patterns during the public holidays on December 25th and 26th were similar to the patterns in the weekends. The DHW heat use during the week that contained Christmas holidays was lower than in a regular week. This can be explained by the fact that some families took their elder relatives home from the nursing homes for Christmas celebrations. Finally, on the last day of holidays elder people were arriving back to the nursing home. Therefore, January 1st, the DHW heat use was becoming similar to a regular day. Thereby, during the holidays, water use was usually reduced.

4.2. DHW heat use profiles aggregated by similar days of the weeks and seasons

Fig. 7 shows average daily DHW heat use per room for each month and corresponding outdoor temperature.

From Fig. 7, strong negative correlation between monthly DHW heat use and outdoor temperature may be noted. In nursing homes, it is expected that the routines for DHW use are simi-

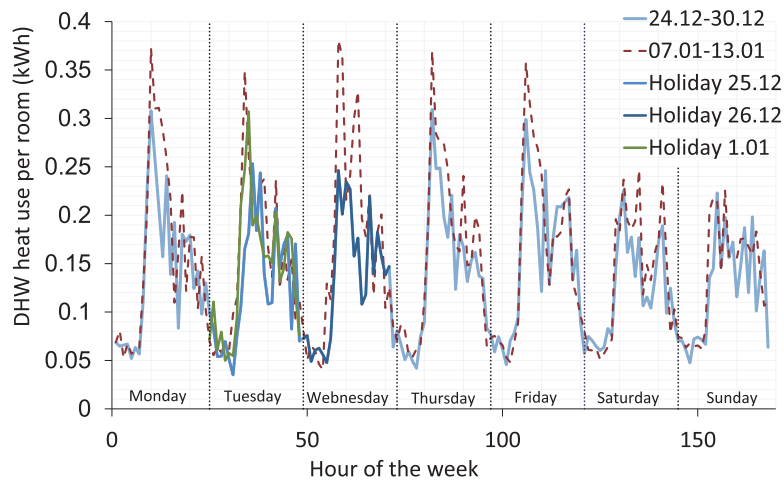

Fig. 6. DHW heat use within the Christmas holidays.

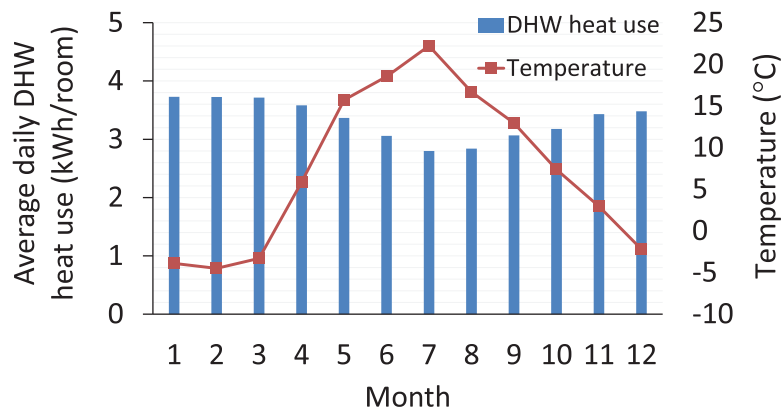

Fig. 7. Daily DHW heat use and outdoor temperature for different months over the year.

lar around the year, and the variation on monthly heat use for DHW can be described by the variation in cold fresh water inlet temperature [42]. Through our investigation of the correlation between the monthly heat use and the lagged monthly average outdoor temperature, the highest coefficient of determination, 0.96, was found between the monthly heat use and the average outdoor temperature of the previous month. This fits well with the fact that the cold inlet water temperature has a slow response to the outdoor temperature. Further, this effect leads to seasonal variation of the DHW heat use in the nursing homes. Therefore, to take into account variation of the DHW heat use in the nursing homes over a year, the seasonality was investigated. The number of seasons during the year and the months associated with each season were identified based on the average daily DHW heat use for nursing homes in different months, applying the method described in Section 2.3. Using Student's t-test, the months of the year were divided into two groups with substantially different mean values of the heat use within each group. The results of the seasonality identification are shown in Fig. 8. The groups represent the cold and warm seasons. The cold season included the following months: January, February, March, April, May, November, and December. Meanwhile, June, July, August, September, and October were assigned to the warm season. Finally, for these seasons were developed separate profiles of DHW use.

As explained in the method, Section 2.1, at the next step of the investigation, the days of the week were assessed for similarity. The DHW heat use data from nursing homes were divided into separate weeks. In total, there were 52 full weeks within the

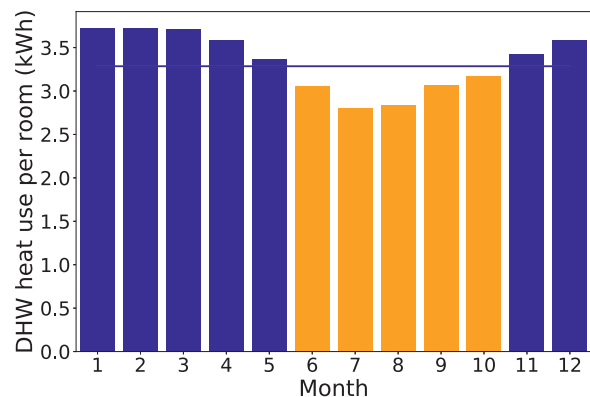

Fig. 8. Cold and warm seasons of DHW heat use in nursing homes.

year. According to the method in Section 2.1, within each week, all combinations of daily DHW profiles were systematically compared among themselves by Student's t-test and Fisher exact test. The matrix of matching of daily profiles is shown in Table 3.

In order to find the critical value that shows when the profiles in different days of the week could be considered as statistically similar, the three following factors were taken into account: the accuracy of Student's t-test, the accuracy of Fisher's exact test, and percentage of days in the year when the buildings operation was not typical, including holidays. The accuracy of Student's t-test and

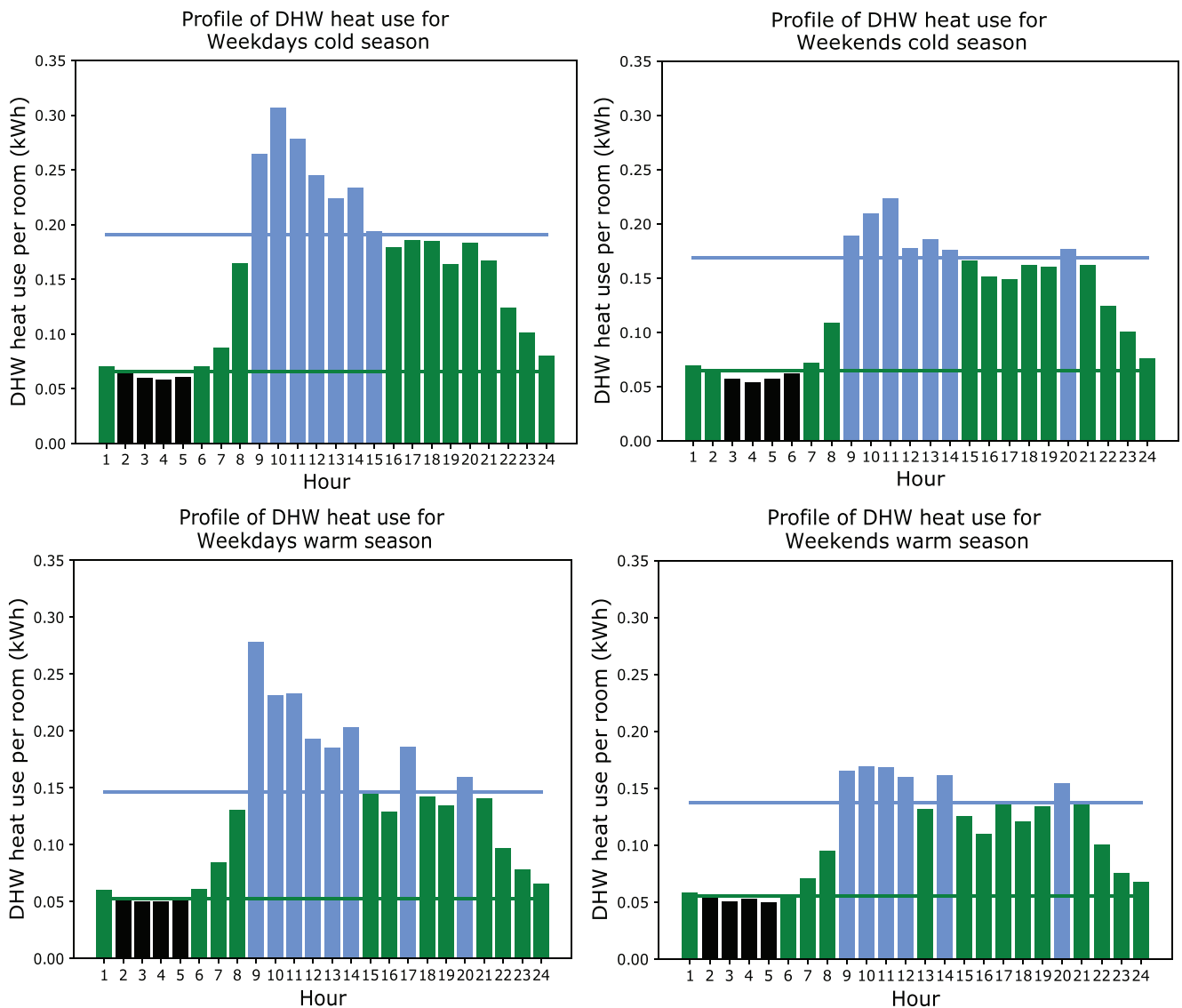

Fig. 9. Profiles of DHW heat use in the nursing homes divided by day of week and seasons.

Table 3
Matrix of matching daily DHW heat use profiles in nursing homes.

	Mo.	Tu.	We.	Thu.	Fr.	Sa.	Su.
Mo.	100	–	–	–	–	–	–
Tu.	93	100	–	–	–	–	–
We.	97	97	100	–	–	–	–
Th.	87	97	93	100	–	–	–
Fr.	95	97	97	97	100	–	–
Sa.	32	59	32	55	51	100	–
Sun.	30	71	48	71	61	97	100

Fisher’s exact test were accepted equal to 5%. In addition, taking into account the number of the days with untypical DHW heat use, the values of the acceptable error (see Section 2.1) was estimated as 14%. Therefore, the days of the week in nursing homes that have statistically similar profiles in more than 86% of the considered weeks were identified, see Table 3. Based on this conclusion, the following groups of the days were identified:

- The first group: 1) Monday, Tuesday, Wednesday, Thursday and Friday,
- The second group: 2) Saturday and Sunday.

Detailed DHW heat use profiles organized by similar days of the weeks and seasons are shown in Fig. 9. For these profiles, the time zones were identified based on average daily DHW heat use by the method explained in Section 2.2. Fig. 9 demonstrated the time zones with a peak heat load (heat use above E_{max} , see Equation 6), minimum (heat use below E_{min} , see Equation 5) and average (heat use in the range between E_{min} and E_{max}) heat load of DHW. The borders between time zones in Fig. 9 are shown in the form of the horizontal lines.

The identification of the time intervals when minimum, average, and peak heat use occurred during the day was one of the key information from the analysis of the DHW heat use profiles. Thereby, the application of the method presented in the Section 2.2 allowed us to determine the following borders of time zones:

- 1) The peak heat use of the DHW heat use occurred when the heat use was higher than: 0.19 kWh/room for Monday-Friday in the cold season, 0.168 kWh/room for Saturday-Sunday in the cold season, 0.147 kWh/room for Monday-Friday in the hot season, and 0.137 kWh/room for Saturday-Sunday hot season;
- 2) The minimum heat use of the DHW heat use occurred when the heat use was less than: 0.066 kWh/room for Monday-Friday

in the cold season, 0.065 kWh/room for Saturday-Sunday in the cold season, 0.053 kWh/room for Monday-Friday in the hot season, and 0.052 kWh/room for Saturday-Sunday in the hot season;

- 3) The average heat use of the DHW heat use occurred when it was between: 0.066 kWh/room and 0.19 kWh/room for Monday-Friday in the cold season, between 0.065 kWh/room and 0.168 kWh/room for Saturday-Sunday in the cold season, between 0.053 kWh/room and 0.147 kWh/room for Monday-Friday in the hot season, and between 0.052 kWh/room and 0.137 kWh/room for Saturday-Sunday in the hot season.

From Fig. 9 it can be observed that the hourly values of the DHW heat use, as well as its peak, were much higher from Monday to Friday compared to Saturday and Sunday. In general, DHW heat use during the cold season was higher than in the warm season. Moreover, in the different seasons, there are some shifts in intensity of the DHW heat use between the hours. From Monday to Friday in the cold season, the peak of the DHW heat use occurred from 9:00 to 15:00 o'clock, with the maximum heat use from 9:00 to 11:00 o'clock. Opposite, the evening peak in the cold season was not clear and cannot be observed easily. Sunday and Saturday in the cold season, the maximum of the DHW heat use was much lower and may be noticed at 11:00 o'clock. Furthermore, the low peak heat use appeared at 20:00 o'clock. Meanwhile, in the working days in the warm season, the peak of DHW heat use occurred from 9:00 to 14:00 o'clock, with the maximum heat use at 10:00 o'clock and the values that are close to the maximum at 9:00 and 11:00 o'clock. In addition, two small peaks could be observed at 17:00 and 20:00 o'clock in the warm season. In the weekends in the warm season, the peak was from 9:00 to 12:00 o'clock, and at 14:00 and 20:00 o'clock. The minimum of the DHW in all the profiles was at night, usually from 2:00 until 5:00 o'clock.

Changes of the DHW heat use intensity and the occurrence of the peak values of the heat use in different profiles in Fig. 9 could be explained by different work regimes in the nursing homes at the weekends and the working days, as well as at different seasons. In general, our study showed that dividing the DHW heat use profiles by seasons and days of the week was reasonable. The profiles obtained in this way were more informative and allow us retrieve additional information about DHW heat use in buildings.

4.3. Comparison of the standard profiles for DHW heat use with the profiles obtained based on measurement data

In this section, two standards were compared with the profiles obtained from the measurements and analysis in Section 4.2 in the nursing homes. The Norwegian standard, "SN/TS 3031:2016: Energy performance of buildings. Calculation of energy needs and energy supply" [43] is a national standard for calculations of buildings energy need and heat losses. Among different information, this standard gives recommendation on DHW heat use profiles per m² in nursing homes that should be used as an input for energy demand calculation [43]. The standard "NS-EN 12831-3:2017: Energy performance of buildings" [44] is European standard, which is recommended for application in Norway. NS-EN 12831-3 provides reference profiles of DHW heat use per person in nursing home. As mentioned earlier, in Norway, each room in the nursing homes is occupied by only one person. Thus, heat use per room is approximately equal to heat use per person. The profiles in the both standards show DHW tap heat use without losses in the storage tank and the system. Meanwhile, typically the measurements in the nursing homes include losses in the storage tanks. For this reason, to remove the losses from the profiles obtained by measurements, the method proposed in [45] was used in this study. This method is based on the assumption that the hourly DHW

heat use with minimum values represents system losses [43]. Consequently, extracting the minimum DHW heat use during these hours from measured data gives us approximate value of the DHW heat use without system and tank losses. Accordingly, using profiles in Fig. 9, the hour with the minimum DHW heat use was identified. After that, the DHW heat use profiles were recalculated according to the method in [45]. The DHW system losses obtained by this method were approximately 20% of the total DHW heat use. For the comparison, both profiles obtained by the measurements with adjustments according to the losses, and the profiles from the standards SN/TS 3031 and NS-EN 12831-3 are presented in Fig. 10. In addition, for a better understanding of the DHW heat use in the nursing homes, the box plots of hourly DHW heat use per m² and per room are presented in the Fig. 11.

Fig. 10 indicates on the big difference between the DHW heat use profiles obtained from the measurements and both standards. The comparison with actual profiles showed the following drawbacks of the standards: 1) standards are not taking into account seasonality and influence of the day of the week on DHW heat use, 2) standards significantly overestimate average daily DHW heat use 2) for certain hours the profiles in the standards overestimate or underestimate DHW heat use, 3) standards can not properly reflect hours with peak and minimum DHW heat use.

The profile in the standard SN/TS 3031, see Fig. 10. a), overestimated the daily DHW heat use in the nursing homes approximately 3.5 times. Even if we compare it with the maximum heat use in the nursing homes, shown in the box plot, see Fig. 11. a), the DHW heat use in the standard SN/TS 3031 was still much higher. Despite this fact, the standard making the assumption that there is no DHW heat use from 1:00 to 5:00 o'clock. The actual profiles, see Fig. 10, showed a small amount of DHW heat use even at night time.

Information about magnitude and timing of the peak heat use in the buildings is crucial for solving a number of issues in energy planning. However, from Fig. 10. a) we can see that SN/TS 3031 is not representing this information in a proper way. From the standard profile, we could assume that the morning peak of heat use occurred from 7:00 to 8:00 o'clock, and the similar peak could be observed from 18:00 to 19:00 o'clock. Meanwhile, in the profile based on actual measurements, the maximum DHW heat use was from 9:00 to 11:00 o'clock, and the evening peak was not clearly visible. The peak value in the standard is 3.7 times higher than in the measured profile. These differences between the profiles were significant and they show the drawbacks of the standard SN/TS 3031. It should be noted that a sample of three nursing homes is probably not enough to be sure that the measurements are representative for the national average. However, this sample represented well the DHW heat use in nursing homes in the central part of Eastern Norway.

The standard, NS-EN 12831-3, overestimated the daily DHW heat use by 1.65 times, see Fig. 10. b). Unlike SN/TS 3031, the standard NS-EN 12831-3 shows DHW heat use at night time, which makes it more realistic. The values in the NS-EN 12831-3 standard are closer to the maximum than the average hourly values of the DHW heat use in the nursing homes presented in Fig. 11. b). From Fig. 10. b) it may be noted that the timing of the actual peaks of the DHW heat use did not match perfectly the information in the standard NS-EN 12831-3. The morning peak of heat use in the standard is shown from 7:00 to 8:00 o'clock. It is shifted by two hours compared with the actual one, see Fig. 10. b). The value of the maximum DHW heat use in the standard is 2.7 times higher than in the profile based on measurement. The behaviour of DHW in the evening time was similar to the measured profile. Despite the fact that NS-EN 12831-3 is the international standard, it explains the DHW nursing home heat use much better than the Norwegian national standard SN/TS 3031.

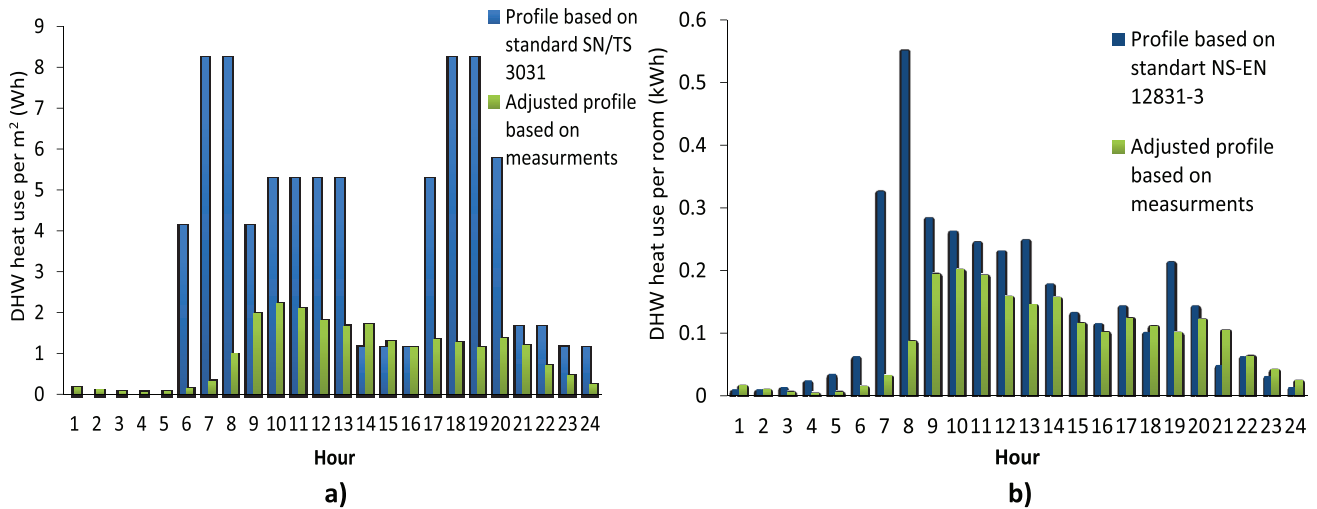

Fig. 10. Hourly profiles of DHW heat use according to the standards and measurements in the nursing homes, where a) standard SN/TS 3031 b) NS-EN 12831-3.

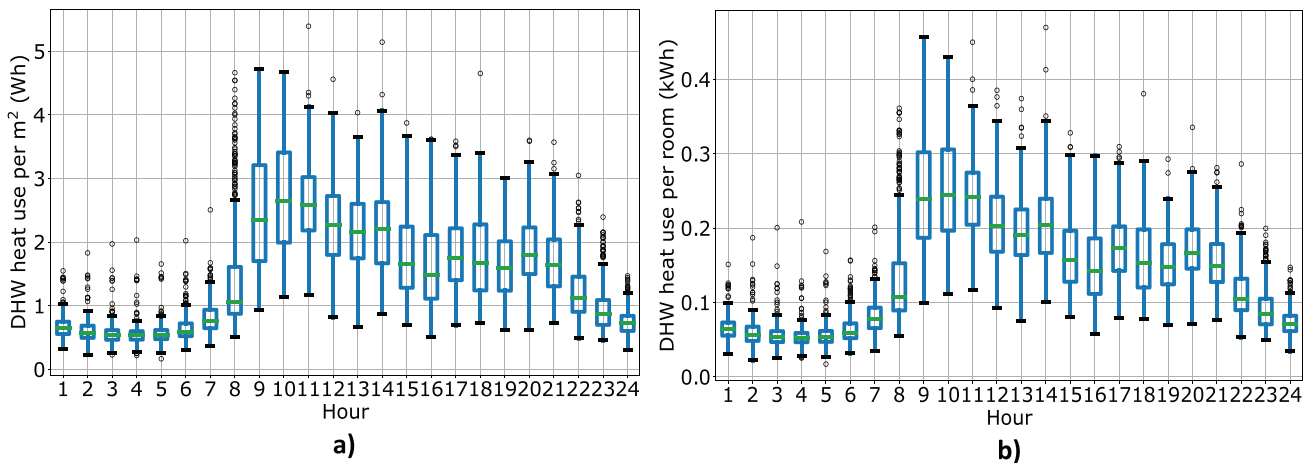

Fig. 11. Hourly profile of DHW heat use obtained by measurements, where: a) DHW heat use per m^2 , b) DHW heat use per room.

There could be several reasons for the inaccuracy of the profiles in the standards. First, the majority of the standards are based on information and data obtained decades ago [17]. The introduction of new types of DHW appliances, changes in routines and behaviours in the nursing homes are also likely changing the assumed values from the standards. Consequently, standards cannot correctly display the current state of the DHW heat use in buildings, because the standards are developed to give limits and guidelines and cannot determine the real use. The other reason is that the profiles given in the standards are usually too simplified to enable their easier implementation by practitioners. These profiles were created for certain categories of buildings: nursing homes, school, hotel, offices, etc. However, even within one category of the buildings, the DHW heat use can behave differently. The location of the building in different parts of the country with specific temperature conditions is also factor that could lead to uncertainty.

The above mentioned standard profiles are commonly used for calculation of the building performance against national regulations. If the standard profiles deviates significantly from the reality, it may lead to unwanted effects. For example in Norway, there is a demand that above 60% of the energy demand for heating and DHW should be covered by a centralized system without fossil fuels. In cases with highly insulated buildings, the standard DHW heat demand may represent above 60% of the total heating de-

mand. If the real DHW use is much lower than the standard calculation, the standard requirements on the system design will have unwanted effects on choosing energy supply systems and sizing the energy infrastructure.

Therefore, this study showed that dividing the DHW heat use profiles by season and days of the week is reasonable. These profiles should be based on accurate and up-to-date statistical data from real buildings and reliable methods of processing available information. The potential for energy saving, can be achieved by better DHW system sizing, introducing of demand-side management, and other energy saving measures. Representative profiles will form a basis for the proper implementation of energy saving measures and increasing the efficiency of DHW heat use in nursing homes.

5. Conclusions

DHW system is a significant consumer of energy in buildings. With the introduction of highly insulated building structures and technologies of passive houses, the share of the DHW heat use in the total energy balance of the buildings is continuously increasing. Accordingly, reducing the DHW heat use in buildings becoming a more important target.

The review of the literature showed that there is a gap in knowledge about actual DHW heat use in buildings. Specific heat use in the nursing homes is one of the highest comparing to other types of buildings. Therefore, analysis of the DHW heat use in nursing homes is particularly relevant for Norway. To increase energy efficiency in the DHW systems in Norway, an extensive analysis should be carried in various types of buildings. One of the most critical problems of such analysis is the development of up-to-day profiles of the DHW heat use. These profiles should accurately reflect DHW heat use in the buildings and fill gaps in existing standards. In this article, the relevant problem was investigated for nursing homes located in the Eastern Norway.

Analysis of the measurements in three nursing homes showed a strong negative correlation between the monthly DHW heat use and the outdoor temperature. Consequently, seasonality is an essential factor that should be taken into account for DHW heat use profiles for nursing homes. The other significant factor identified in the article was the day of the week. For the DHW heat use analysis, the statistical approach that allowed us to develop unified profiles divided by months and days of the week with similar behaviour of DHW heat use was suggested. Based on this approach the months of the year for the nursing homes were divided into two groups: the cold season (January, February, March, April, November, December) and the warm seasons (June, July, August, September, October). Comparison of the profiles in different days of the week showed that weekends and working days should be considered separately. Furthermore, a method for determining the time zones with the peak, the minimum, and the average heat use in the daily profile of the DHW heat use was applied.

For the nursing homes, the profiles obtained by seasons showed that the DHW heat use in the cold season was higher than in the warm season. Besides, nursing homes used less heat for DHW in the weekends than in the working days. The maximum DHW heat use in nursing homes usually occurred from 9:00 o'clock to 11:00 o'clock, and minimum from 2:00 to 5:00 o'clock.

Finally, the DHW heat use profiles obtained from the measurements in the nursing homes were compared with profiles from national standard SN/TS 3031:2016 and international standard NS-EN 12831-3:2017. The comparison showed that the European standard, NS-EN 12831-3, overestimated the daily DHW heat use by 1.65 times, and the Norwegian standard, SN/TS 3031, overestimated it by 3.5 times. The magnitude and timing of the peak heat use in the buildings was also different from the standards. The European standard explains much better the actual DHW heat use in the nursing homes than the Norwegian standard. For practical application and relevant decisions related to building energy supply systems, preference should be given to profiles obtained on the basis of statistical data collected in real buildings.

The study in this work was limited to only three nursing homes. For this reason, in the future work, the analysis in larger amount of nursing homes and other types of buildings will be performed. For a larger amount of buildings, the application of different clustering methods for the analysis of DHW heat use will be tested. In addition, the question of predicting the DHW heat usage profiles will be considered in further studies.

Declaration of Competing Interest

The authors declare that they have no known competing financial interests or personal relationships that could have appeared to influence the work reported in this paper.

CRedit authorship contribution statement

Dmytro Ivanko: Conceptualization, Methodology, Formal analysis, Software, Investigation, Writing - original draft, Visualization,

Writing - review & editing. **Harald Tact Walnum:** Data curation, Formal analysis, Writing - review & editing. **Natasa Nord:** Conceptualization, Formal analysis, Writing - original draft, Supervision, Writing - review & editing.

Acknowledgement

This article has been written within the research project "Energy for domestic hot water in the Norwegian low emission society". The authors gratefully acknowledge the support from the Research Council of Norway (ENERGIX-programme), SINTEF Community, Department of Energy and Process Engineering at NTNU, Drammen Eiendom, Omsorgsbygg, Boligbygg, OBOS, Olav Thon Gruppen, Armaturjonsson, Høiax, Geberit, Uponor and FM Mattsson.

References

- [1] European Commission, Energy Performance of Buildings Directive, Available from: <https://ec.europa.eu/energy/en/topics/energy-efficiency/energy-performance-of-buildings> (Accessed October 16, 2019).
- [2] M. Jamieson, O. Brajterman, Y. Verstraeten, J. Arbon, EPBD Compliance Study - Final Report, Publications Office of the European Union, (2015) pp. 138.
- [3] European Commission, Energy Roadmap 2050, Available from: <https://eur-lex.europa.eu/legal-content/EN/TXT/PDF/?uri=CELEX:52011DC0885&from=EN> (Accessed October 16, 2019).
- [4] E. Abel, P.-E. Nilsson, L. Ekberg, P. Fahlen, L. Jagemar, R. Clark, O. Fanger, K. Fitzner, L. Gunnarsen, P.V. Nielsen, Achieving the desired indoor climate-energy efficiency aspects of system design, Lund: Studentlitteratur: Comtech Group (2003).
- [5] E. Fuentes, L. Arce, J. Salom, A review of domestic hot water consumption profiles for application in systems and buildings energy performance analysis, Renewable and Sustainable Energy Reviews 81 (2018) 1530–1547.
- [6] V. Foldvary, L. Borisova, D. Petras, Energy use and thermal comfort of two apartment buildings before and after refurbishment in Slovakia, REHVA European HVAC Journal 50 (5) (2013) 52–56.
- [7] T. Peters, J. Weyer, Architectural design for low energy housing: Experiences from two recent affordable housing projects in Denmark, in: Proceedings of Sustainable cities and buildings: 7th Passive House Norden Conference, DTU Byg and KADK Copenhagen, Denmark, 2015, pp. 1–10.
- [8] J. Hirvonen, J. Jokisalo, J. Heljo, R. Kosonen, Towards the EU emissions targets of 2050: optimal energy renovation measures of Finnish apartment buildings, International Journal of Sustainable Energy 38 (7) (2019) 649–672.
- [9] S. Medved, S. Domjan, C. Arkar, Sustainable Technologies for Nearly Zero Energy Buildings, Springer International Publishing (2019).
- [10] S. Attia, P. Eleftheriou, F. Xenii, R. Morlot, C. Ménézo, V. Kostopoulos, M. Betsi, I. Kalaitzoglou, L. Pagliano, M. Almeida, Overview of challenges of residential nearly Zero Energy Buildings (nZEB) in Southern Europe, in: Sustainable Buildings Design Lab, Technical Report, Liege, Belgium, 2016, pp. 87.
- [11] B. Bøhm, Production and distribution of domestic hot water in selected Danish apartment buildings and institutions. Analysis of consumption, energy efficiency and the significance for energy design requirements of buildings, Energy conversion and management 67 (2013) 152–159.
- [12] G. Cossali, M. Ratcliffe, E. Routledge, T. Karayiannis, J. Fielder, The cost of Legionellosis and technical ways forward, in: Proceedings of CIBSE Technical Symposium. Liverpool John Moores University, Liverpool, UK, 2013, pp. 1–9.
- [13] I. Knight, N. Kreutzer, M. Manning, M. Swinton, H. Ribberink, European and Canadian non-HVAC electric and DHW load profiles for use in simulating the performance of residential cogeneration systems, International Energy Agency, Annex 42 (2007).
- [14] S. Tyler, L. Schipper, The dynamics of electricity use in Scandinavian households, Energy 15 (10) (1990) 841–863.
- [15] K. Ahmed, P. Pylysy, J. Kurnitski, Monthly domestic hot water profiles for energy calculation in Finnish apartment buildings, Energy and Buildings 97 (2015) 77–85.
- [16] G. Levermore, W. Chong, Performance lines and energy signatures: review and analysis, Building Services Engineering Research and Technology 10 (3) (1989) 105–114.
- [17] T.-A. Koiv, A. Mikola, A. Toode, DHW design flow rates and consumption profiles in educational, office buildings and shopping centres, Smart Grid and Renewable Energy 4 (03) (2013) 287–296.
- [18] G. Curculacos, G. Turchetto, U. Mazzali, F. Peron, P. Romagnoni, F. Cappelletti, F. Bauman, M. Scarpa, On the Energy Performance Design of a Skilled Nursing Facility Building, in: Proceedings of 3rd International High Performance Buildings Conference at Purdue, 2014, pp. 1–10.
- [19] J. Tindall, J. Pendle, Are we significantly oversizing domestic water systems?, in: Proceedings of CIBSE Technical Symposium, London, UK, 2015, pp. 1–23.
- [20] M. Kouveletsou, N. Sakkas, S. Garvin, M. Batic, D. Reccardo, R. Sterling, Simulating energy use and energy pricing in buildings: The case of electricity, Energy and Buildings 54 (2012) 96–104.
- [21] A. Reynaud, M. Pons, C. Pesado, Household Water Demand in Andorra: Impact of Individual Metering and Seasonality, Water 10 (3) (2018) 321.

- [22] X. Yang, S. Svendsen, H. Li, Supply of domestic hot Water at comfortable temperatures by low-temperature district heating without risk of Legionella, in: Technical University of Denmark, Department of Civil Engineering, DTU Civil Engineering Report., 2016, pp. 140.
- [23] H. Ahmad, Energy Efficiency Solutions for Domestic Hot Water, Online publisher: bigee.net, (2017) p. 1-5.
- [24] L. Tronchin, K. Fabbri, Energy performance building evaluation in Mediterranean countries: Comparison between software simulations and operating rating simulation, *Energy and buildings* 40 (7) (2008) 1176–1187.
- [25] N. Djuric, V. Novakovic, Identifying important variables of energy use in low energy office building by using multivariate analysis, *Energy and Buildings* 45 (2012) 91–98.
- [26] K. Ahmed, P. Pylsy, J. Kurnitski, Hourly consumption profiles of domestic hot water for different occupant groups in dwellings, *Solar Energy* 137 (2016) 516–530.
- [27] I. Verhaert, B. Bleys, S. Binnemans, E. Janssen, A methodology to design domestic hot water production systems based on tap patterns, in: Proceedings of CLIMA 2016: 12th REHVA World Congress, Aalborg, Denmark, 2016, pp. 1-10.
- [28] E. Wilson, C. Engebrecht-Metzger, S. Horowitz, R. Hendron, 2014 Building America house simulation protocols, in: National Renewable Energy Laboratory, Technical Report, Golden, United States, 2014, pp. 91.
- [29] F. Lombardi, G. Silvagni, P. Sirini, R. Spagnuolo, F. Volpi, Daily water demand, *An Interdisciplinary Journal of Applied Science* 13 (5) (2018) 1–11.
- [30] N. Good, L. Zhang, A. Navarro-Espinosa, P. Mancarella, High resolution modelling of multi-energy domestic demand profiles, *Applied Energy* 137 (2015) 193–210.
- [31] D. Fischer, T. Wolf, J. Scherer, B. Wille-Hausmann, A stochastic bottom-up model for space heating and domestic hot water load profiles for German households, *Energy and Buildings* 124 (2016) 120–128.
- [32] J. Widen, M. Lundh, I. Vassileva, E. Dahlquist, K. Ellegard, E. Wackelgard, Constructing load profiles for household electricity and hot water from time-use data - Modelling approach and validation, *Energy and Buildings* 41 (7) (2009) 753–768.
- [33] L.G. Swan, V.I. Ugursal, I. Beausoleil-Morrison, Occupant related household energy consumption in Canada: Estimation using a bottom-up neural-network technique, *Energy and Buildings* 43 (2011) 326–337.
- [34] E. Pieterse-Quirijns, A. Van Loon, H. Beverloo, E. Blokker, E. Van der Blom, J. Vreeburg, Validation of non-residential cold and hot water demand model assumptions, *Procedia Engineering* 70 (2014) 1334–1343.
- [35] I. Pieterse-Quirijns, Manual SIMDEUM Pattern Generator. Tool for water demand and discharge patterns for residential and non-residential buildings, in: KWR Water Research Institute, The Netherlands, 2014, pp. 99.
- [36] C. Agudelo-Vera, E. Pieterse-Quirijns, W. Scheffer, E. Blokker, New method to design domestic water systems, *REHVA European HVAC Journal* 6 (2013) 12–16.
- [37] J. Wiehagen, J. Sikora, Domestic hot water system modeling for the design of energy efficient systems, NAHB Research Center, Upper Marlboro, Technical report, (2002) 67.
- [38] E. Vine, R. Diamond, R. Szydlowski, Domestic hot water consumption in four low-income apartment buildings, *Energy* 12 (6) (1987) 459–467.
- [39] H. Kauko, O. Stavset, M. Bantle, N. Nord, Energy use in Norwegian non-residential buildings: building regulations, calculations and measurements, in: Proceedings of 8th International Conference on Heating, Ventilation and Air-Conditioning: Cold Climate HVAC (2015) 1–8.
- [40] V.F. Nakhodov, A.I. Zamilko, M. Al Sharari, D.O. Medintseva, Analysis of duration and border of existing tariff zones, *Power engineering: Economics, Technology, Ecology* 2 (2016) 88–97.
- [41] M.L. Rizzo, G.J. Szekely, Energy distance, *wiley interdisciplinary reviews, Computational statistics* 8 (1) (2016) 27–38.
- [42] O. Gerin, B. Bleys, K. De Cuyper, Seasonal variation of hot and cold water consumption in apartment buildings, in: Proceedings of International Symposium of CIB W062 Water Supply and Drainage for Buildings, Brazil (2014) 1–9.
- [43] SN/TS 3031:2016, Energy performance of buildings. Calculation of energy needs and energy supply, Standard Norge (2016) 168.
- [44] NS-EN 12831-3:2017 Energy performance of buildings - Method for calculation of the design heat load - Part 3: Domestic hot water systems heat load and characterisation of needs, Module M8-2, M8-3, in, 2017, pp. 64.
- [45] A.J. Marszal, C. Zhang, M.Z. Pomianowski, P.K. Heiselberg, K. Gram-Hanssen, A.R. Hansen, Simple methodology to estimate the mean hourly and the daily profiles of domestic hot water demand from hourly total heating readings, *Energy and Buildings* 184 (2019) 53–64.