This is the accepted manuscript version of the article

Cost-optimal energy system design in Zero Energy Buildings with resulting grid impact: A case study of a German multi-family house

Lindberg, K. B., Fischer, D., Doorman, G., Korpås, M., & Sartori, I

Citation for the published version (APA 6th)

Lindberg, K. B., Fischer, D., Doorman, G., Korpås, M., & Sartori, I. (2016). Cost-optimal energy system design in Zero Energy Buildings with resulting grid impact: A case study of a German multi-family house. *Energy and Buildings*, 127(Supplement C), 830-845.

doi:<https://doi.org/10.1016/j.enbuild.2016.05.063>

This is accepted manuscript version.

It may contain differences from the journal's pdf version.

This file was downloaded from SINTEFs Open Archive, the institutional repository at SINTEF

<http://brage.bibsys.no/sintef>

1 Cost-optimal energy system design in Zero Energy Buildings with 2 resulting grid impact: A case study of a German multi-family house

3 Karen Byskov Lindberg^{a,b,c*}, David Fischer^{c,d}, Gerard Doorman^{a,e}, Magnus Korpås^a, Igor Sartori^f

4 ^a Department of Electric Power Engineering, Norwegian University of Science and Technology (NTNU), N-7491
5 Trondheim, Norway

6 ^bNorwegian Water Resources and Energy Directorate (NVE), PO Box 5091, Majorstua, N-0301 Oslo, Norway

7 ^c Department of Smart grids, Fraunhofer Institute for Solar Energy Systems ISE, DE-79110 Freiburg, Germany

8 ^d Kungliga Tekniska Högskolan (KTH), Stockholm, Sweden

9 ^e Statnett SF, PB 4904 Nydalen, N-0484 Oslo, Norway

10 ^f SINTEF Building and Infrastructure, Pb 124 Blindern, N-0314 Oslo, Norway

11 *corresponding author: karen.lindberg@ntnu.no, mobile: +47 99604272

12 Highlights

- 13 • We investigate the optimal energy system design and optimal operation of ZEBs
- 14 • Hourly net electricity load characteristics are provided for all ZEB cases analysed
- 15 • The most important factors that influence the ZEB's grid impact are identified
- 16 • A ZEB heated by natural gas has 45 % higher peak export compared to a ZEB with bio
- 17 • Heat pumps are not cost-optimal in ZEBs with the current energy market situation

18

19 Abstract

20 Zero Energy Buildings (ZEBs) are considered as one of the key elements to meet the Energy Strategy of
21 the European Union. This paper investigates cost-optimal solutions for the energy system design in a ZEB
22 and the subsequent grid impact. We use a Mixed Integer Linear (MILP) optimisation model that
23 simultaneously optimises the building's energy system design and the hourly operation. As a ZEB have
24 onsite energy generation to compensate for the energy consumption, it is both importing and exporting
25 electricity. The hourly time resolution identifies the factors that influence this import/export situation, also
26 known as the building's grid impact. An extensive case study of a multi-family house in Germany is
27 performed. The findings show that the energy system design and the grid impact greatly depend on the
28 ZEB definition, the existing policy instruments and on the current energy market conditions. The results
29 indicate that due to the feed-in-tariff for PV, the cost-optimal energy design is fossil fuelled CHP
30 combined with a large PV capacity, which causes large grid impacts. Further, we find that heat pumps are
31 not a cost-optimal choice, even with lower electricity prices or with increased renewables in the electric
32 power system.

33 **Keywords:** cost-optimality, mixed-integer linear programming (MILP), zero energy building (ZEB), load
34 profiles, grid impact, self-consumption, policy implications, primary energy factor (PE), CO₂ factor, feed-
35 in tariff (FiT), energy system design

36

37 **Table of content**

38 1 Introduction 2
39 2 Case study: Multi-family house..... 5
40 2.1 Cost optimisation model - in brief..... 6
41 2.2 Input parameters of the energy technology models..... 8
42 2.3 Technology costs and energy prices..... 10
43 2.4 Weighting factors – PE and CO₂..... 11
44 3 Results 12
45 3.1 Energy system design 12
46 3.2 Grid impact..... 14
47 4 Sensitivity analysis 17
48 4.1 How robust is the choice of CHP? 17
49 4.2 How does the energy system design affect the ZEB’s grid impact? 20
50 5 Discussions 22
51 5.1 PV size..... 23
52 5.2 Storage size dependent on heat technology 23
53 5.3 Heat pump opportunity in ZEBs..... 24
54 5.4 Solar thermal never chosen 24
55 5.5 Aspects not considered 24
56 6 Conclusion..... 25

57

58 **1 Introduction**

59 In the European Union, buildings are responsible for nearly 40 % of final energy consumption and 36 %
60 of the greenhouse gas emissions [1]. The emissions reflect both *direct emissions*, from the use of gas or oil
61 for heating purposes, and *indirect emissions* through the use of electricity and district heat. The concept of
62 zero energy buildings (ZEB) was introduced in the recast of the Energy Performance of Building’s
63 Directive (EPBD) in 2010, to make the buildings a part of the solution to combat GHG emissions and
64 increase security of supply, by incentivising local energy production as well as energy efficiency.

65 A ‘nearly ZEB’ is an energy efficient building with low energy demand that to a high extent is covered by
66 on-site generated renewable energy [1]. Because ZEBs need on-site energy generation in order to
67 compensate for their energy use, they will inevitably become an active and integrated part of the energy
68 system. This paper, aims to identify which factors that determines the grid impact of ZEB buildings, i.e.
69 how they interact with the electricity grid.

70 *1.1.1 Definition of ZEB buildings*

71 According to the EPBD each member state must develop a definition of the ‘nearly zero energy building’,
72 including a ZEB methodology, and how ‘near’ zero the ZEB target should be. Even though the definition
73 can be set individually, the framework of how to calculate the energy balance is given by the EPBD [2] as

74 follows (see Eq.(1)): the weighted annual energy imports to the building, subtracted the annual weighted
 75 energy exports from the building, summed over all energy carriers, i . The weighting is done by use of
 76 weighting factors f , which are unique for each energy carrier. Using primary energy factors, lead to a Zero
 77 Energy Building (ZEB), whereas using CO₂ factors lead to a Zero Emission Building or Zero Carbon
 78 Building (ZCB). However, in the following, whenever using ZEB, it embraces both ZEB and ZCB.

$$\sum_i f_i \cdot \text{imported}_i - \sum_i f_i \cdot \text{exported}_i = G \quad (1)$$

79 When the balance is strictly zero ($G = 0$), the building is a ‘strictly’ ZEB. To fulfil the target of a strictly
 80 ZEB can be challenging as the weighted on-site energy generation must equalize the weighted energy
 81 consumption of the building¹. The target is fulfilled by reducing the consumption through energy
 82 efficiency measures, and/or applying on-site electricity generation [3]. However, it is also possible to relax
 83 the strictly zero target by letting $G > 0$, heading for a ‘nearly’ ZEB. Thus, maybe the most important
 84 element of the ZEB definition is determining the level of ZEB.

85 Another element of the ZEB definition is what energy consumption to include in the energy balance. For
 86 example, some claim that energy used for elevators or equipment, such as computers or IT-servers, are
 87 dependent on the user and should not be a part of the energy balance of the building [4]. While others
 88 claim that not only all the energy consumed by the building, but also embodied energy of the materials
 89 and construction of the building should be included [5].

90 Summed up, the definition of ZEB that each member state is free to decide, has the following elements:

- 91 1) the *metric* of the weighting factor (primary energy or CO₂)
- 92 2) the *value* of the weighting factors (see examples in Table 4)
- 93 3) the *level* of ZEB (‘strictly’ or ‘nearly’ ZEB)
- 94 4) what *energy consumption* is included (partly operational, all operational, or all operational &
 95 embodied)

96 Previous work in Lindberg et al. [6] show that when applying the ZEB target on a Norwegian building it
 97 mainly affects the energy imports for heat because the electric specific demand of the building (i.e.
 98 electric equipment and lighting), cannot be replaced by other energy carriers than electricity. This is
 99 confirmed in Noris et al. [7] which shows that the weighting factors influence the preferred heat
 100 technology choice. In many European countries, bio energy has the lowest weighting factor because of its
 101 renewable status, thus making a bio boiler the preferred heat technology choice [7]. As an example, when
 102 using the European primary energy factors [2], the weighted energy imports for heating is reduced by a
 103 ratio² of 13 if using a bio boiler rather than a heat pump.

104 1.1.2 ZEB’s grid impact

105 The on-site energy generation in ZEBs often tend to be large PV installations, which is confirmed by
 106 several case studies in e.g. [7]–[12], even though the technology choices may also comprise solar thermal
 107 (ST) modules, micro-wind turbines or micro-CHPs. However, building integrated micro wind turbines
 108 have challenges with noise and vibrations [13], and a ZEB with CHP still needs to compensate for the gas

¹ It can be shown that calculating the balance by weighted energy consumed and generated rather than weighted imported and exported from the building, gives the same answer for the energy balance, G .

² With values from Table 2 and Table 4: (heat from HP) / (heat from BB) = (PE_{electricity} / COP_{HP}) / (PE_{bio} / η_{BB}) = 12,6.

109 imports. Solar thermal can provide heat in summer time, but cannot contribute to the energy exports from
110 the building unless it is attached to a district heating grid.

111 One of the challenges of ZEBs in northern European countries is that heat demand occurs in winter when
112 PV generation is low, thereby making the building importing energy in winter both for heat and electricity
113 demand. To fulfil the zero energy balance of the ZEB building, the electric power system must serve as a
114 seasonal storage that is ‘charged’ in summer and ‘depleted’ in winter. This is also known as the seasonal
115 ‘mismatch’ problem [14]. As electricity needs to be consumed the instance it is produced, there has to be
116 enough electricity demand in the rest of the power system, which can utilize the exported electricity from
117 ZEBs in summer. Likewise, the power system must be able to provide the ZEB buildings with electricity
118 in winter.

119 Hourly or instantaneous ‘mismatch’ is another challenge of the ZEBs. Due to the often large PV
120 installations of ZEB buildings, grid challenges, such as over-voltages, may occur in summer when many
121 ZEBs are located within a geographically small area [15]. To ease the mismatch problems of the
122 individual ZEB buildings, research on local energy systems for small areas are emerging (see e.g. [16]–
123 [18]). The idea is to exploit the characteristics of different energy sources and technologies, e.g. PVs,
124 micro-CHPs and micro-wind, with the different energy demand profiles, e.g. service buildings and
125 residential buildings, and additionally applying smart control on top of it all. Having a local energy system
126 perspective rather than a building perspective [17], showed that the seasonal mismatch problems of the
127 local area can be reduced, even though the mismatch problems of the buildings are unchanged.

128 As the focus in this paper is on a building level, the identified grid challenges of ZEBs are attached to both
129 the seasonal and hourly mismatch problems. It is of vital importance to communicate where policy makers
130 can contribute to ease the grid challenges, but still being able to fulfil the ZEB target given by the EPBD.
131 This paper identifies how the definition of ZEBs and the current energy market conditions and taxes
132 impact the grid challenges of ZEBs. In the literature, the grid challenges are analysed by using several grid
133 indicators (see Salom et al. [8] for a thorough explanation). In this paper, we focus on the graphical
134 presentation of the *net electricity load profiles*, as they show the building’s maximum import and export
135 values and annual electricity exports in an informative way. The self-consumption rate and additional grid
136 connection capacity (GM values) are also presented.

137 1.1.3 *The aim of this study*

138 The aim of this study is to identify the most important factors that affect the ZEB’s grid impact. A case
139 study of a German multi-family house (MFH) is performed, where several input parameters are varied,
140 regarding both energy market conditions and the definition of ZEB. We use a mixed-integer optimisation
141 model, which is introduced and described in Lindberg et al. [6], hence only a brief introduction of the
142 model concept is given in this paper. To the authors’ knowledge, only Milan et al. [9] presents a similar
143 model on a building scale. The model introduced in Lindberg et al. improves Milan’s model in two ways;
144 1) by applying binary variables on the investment decision and hourly heat generation, making it a mixed-
145 integer linear optimization problem (MILP), and 2) expanding the implemented number of energy
146 technologies, including the sizing of the heat storage. Ten different energy technologies are implemented,
147 and the model finds the optimal mix and size that minimises total discounted costs over the lifetime of the
148 building. Through the model’s hourly time-resolution, the cost-optimal hourly operation is also
149 undertaken, enabling investigation of the hourly electricity import and export from the building.

150 Based on the case study, we show that the most important factors that influence the building's net electric
 151 load profile are: 1) how 'near' zero the ZEB target is, and 2) the choice of heat technology, which is
 152 influenced by the value of the weighting factors, technology costs, energy prices, and policy instruments
 153 (investment support schemes, feed-in-tariffs, taxes).

154 *1.1.4 Paper structure*

155 Section 2 introduces the case study and presents the cost-optimisation model and input parameters.
 156 Section 3 shows the results of the German MFH while applying a 'nearly' ZEB target, a 'strictly' ZEB
 157 target, and for comparison, a case without any ZEB target. In Section 4, sensitivity analysis are performed,
 158 investigating how future market conditions may influence the energy system design and the grid impact.
 159 Section 5 provides general discussion of selected results, before making final conclusions in Section 6.

160 **2 Case study: Multi-family house**

161 A case study of a simulated multi-family-house (MFH) located within the area of Berlin in Germany is
 162 performed. The building is a representative new MFH according to German statistics and is assumed to
 163 have 10 apartments and a total heated area of 1000 m². The architectural design and building physics are
 164 treated as given, and fulfils the passive standard. The energy technologies implemented in the model are
 165 chosen according to the available energy carriers in the region. The total system scheme, including the
 166 implemented energy technologies, is shown in Figure 1.

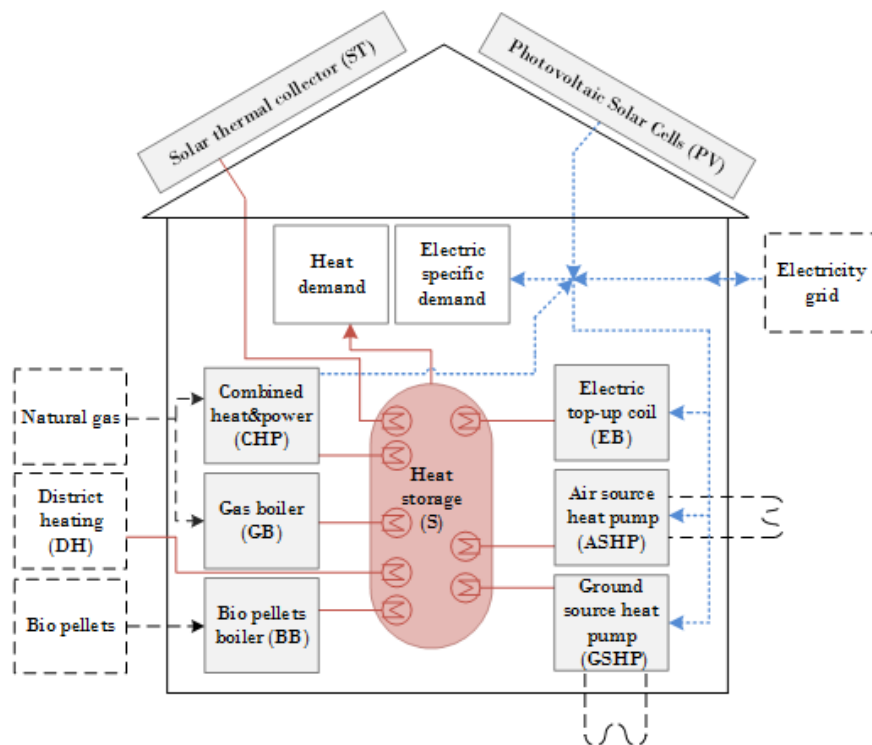

Figure 1 System scheme and energy flows of the building.

167

168 The ZEB target is in this case study defined to include operational energy consumption, i.e. embodied
 169 energy is not taken into account. Even though the target is set on an annual basis, the energy consumed

170 and generated are calculated each hour, making the building importing electricity in some hours, and
 171 exporting electricity in other hours.

172 The inputs to the model described in Section 2.2 are fitted to the climatic conditions and energy market
 173 conditions for the region of Berlin. This especially affects the heat demand of the building, the hourly
 174 COP of the heat pumps, the energy generation from ST and PV panels, and the feed-in-tariffs of electricity
 175 from PV and CHP. The lifetime of the building is set to 40 years, and the calculations are done with a
 176 discount rate of 4 %.

177 2.1 Cost optimisation model - in brief

178 This section briefly describes the cost optimisation model which is implemented in MOSEL Xpress [19].
 179 For an in-depth description, see Lindberg et al. [6].

180 Figure 2 illustrates the basic idea of the model, where total costs are minimised, based on inputs of
 181 technology costs, prices and the building's energy demand. Hence, the optimal investments and operation
 182 of the building are decided simultaneously. The main outputs are capacity sizes of the chosen energy
 183 technologies, together with their hourly fuel consumption. Accordingly, the building's hourly net electric
 184 load profile is found, which forms the basis for analysing the grid impact.

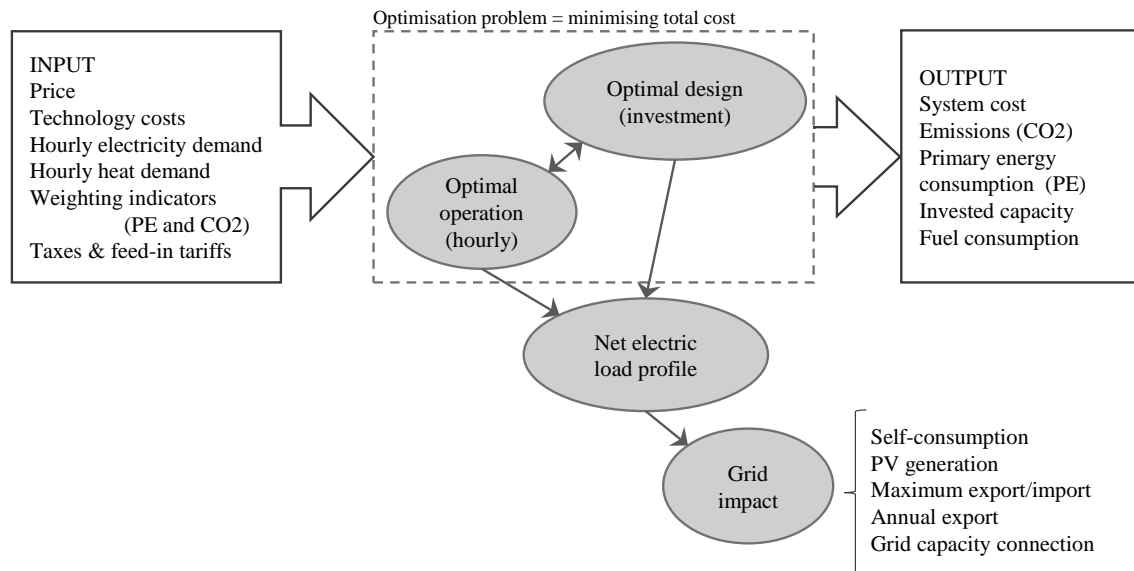

185 Figure 2 Model description with main inputs and outputs. Grid impacts are consequences of the optimal design and operation.

186 The objective function π represents the net present value of the total costs of the energy system within the
 187 building, which depends on the installed capacity, x , of each energy technology i . The discounted
 188 investment costs, C^{inv} , consist of reinvestments throughout the entire lifetime of the building, N , minus
 189 its salvage value at the end of the lifetime. C^{run} is the sum of fixed maintenance costs and variable fuel
 190 costs. The discounted net present value of the total operational costs equals the annual operational costs
 191 multiplied by the net present factor, ρ . The annual fuel costs are calculated each hour throughout one
 192 representative year within each period. The building's energy system must fulfil equality $\mathbf{h}(\mathbf{x})$, and

193 inequality $\mathbf{g}(\mathbf{x})$, constraints dependent on the installed capacity for all the energy technologies, forming
 194 the vector \mathbf{x} .

$$\min \pi = \sum_{i \in I} C_i^{\text{inv}}(x_i) + \rho \cdot C_i^{\text{run}}(x_i) \quad , \quad \text{where } \rho = \sum_{\tau=1}^N \frac{1}{(1+r)^{\tau-1}} \quad (2)$$

s.t. $\mathbf{h}(\mathbf{x}) = 0$
 $\mathbf{g}(\mathbf{x}) \leq 0$

195
 196 The electricity balances of the building, given in Eq.(3)-(6), are influenced by the special electricity tariffs
 197 in Germany (see Section 2.3.2). As described graphically in Figure 3, the tariff structure makes it
 198 necessary to keep the flows of self-consumed electricity ($y_{i,t}^{\text{selfcD}}$, $y_{i,t}^{\text{selfcHP}}$), exported electricity ($y_{i,t}^{\text{exp}}$) and
 199 imported electricity ($y_{i,t}^{\text{impD}}$, $y_{i,t}^{\text{impHP}}$) separate. Notice that the building's electricity consumption includes
 200 both the electric specific demand of the building, D_t^{el} , and the electricity consumed by the electric boiler,
 201 $d_{\text{EB},t}$, and the heat pumps, $d_{\text{ASHP},t}$, $d_{\text{GSHP},t}$.

Building: $D_t^{\text{el}} + d_{\text{EB},t} = y_{\text{PV},t}^{\text{selfcD}} + y_{\text{CHP},t}^{\text{selfcD}} + y_t^{\text{impD}} \quad \forall t \quad (3)$

Heat pump: $d_{\text{ASHP},t} + d_{\text{GSHP},t} = y_{\text{PV},t}^{\text{selfcHP}} + y_t^{\text{impHP}} \quad \forall t \quad (4)$

PV: $y_{\text{PV},t} = y_{\text{PV},t}^{\text{exp}} + (y_{\text{PV},t}^{\text{selfcD}} + y_{\text{PV},t}^{\text{selfcHP}}) \quad \forall t \quad (5)$

CHP: $y_{\text{CHP},t} = y_{\text{CHP},t}^{\text{exp}} + y_{\text{CHP},t}^{\text{selfcD}} \quad \forall t \quad (6)$

202

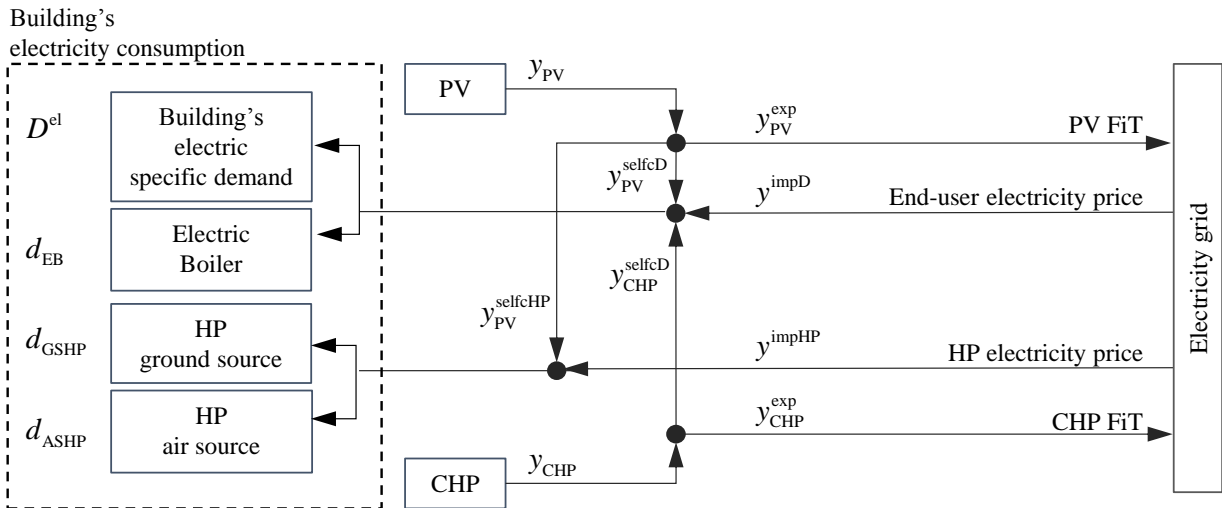

Figure 3 Detailed graphical explanation of the electricity flows in Figure 1, together with their electricity price or export value.

203

204 The net electric load profile of the building, ne_t , is equal to the electricity imported subtracted the
 205 electricity exported from the building to the grid, as presented in Eq. (7), and illustrated in Figure 3.

$$\begin{aligned}
 ne_t &= \text{electricity import } (t) - \text{electricity export } (t) \\
 &= \left(y_t^{\text{impD}} + y_t^{\text{impHP}} \right) - \left(y_t^{\text{PVexp}} + y_t^{\text{CHPexp}} \right)
 \end{aligned}
 \tag{7}$$

206

207 **2.2 Input parameters of the energy technology models**

208 This section presents the input parameters of the energy technologies, and for determining the load
 209 profiles of heat and electricity demand.

210 *2.2.1 Building's energy demand*

211 Hourly energy loads are constructed using SynPro, a bottom-up model where stochastic behaviour of the
 212 occupants is linked to the stock of electric appliances [20]. First the electricity load and domestic hot
 213 water load (DHW) is determined based on stochastic behaviour of the residents sampled from the German
 214 time-of-use-survey [21], and secondly, the electricity load is set as internal gains when determining the
 215 space heat demand calculated for climatic conditions of Potsdam for 2012 [22]. The U-values of the
 216 building envelope are set according to the German passive building standard. The resulting annual heat
 217 demand (sum of space heating and DHW) and electric specific demand are respectively 28 MWh/yr and
 218 33 MWh/yr. The maximum hourly peak demand is 23 kW and 13 kW, for heat and electricity
 219 respectively.

220 *2.2.2 Hourly COP for air source and ground source heat pumps*

221 The heat pump models for air source heat pump (ASHP) and ground source heat pump (GSHP) take the
 222 supply temperature into account. The heating curve used to determine the supply temperature for space
 223 heating is shown in Figure 4, and the average supply temperature of the DHW is assumed to be 55°C.
 224 Together with the COP models presented in [6], and the heat demand determined in Section 2.2.1, the
 225 hourly COPs for 2012 for Potsdam are found (see Figure 5).

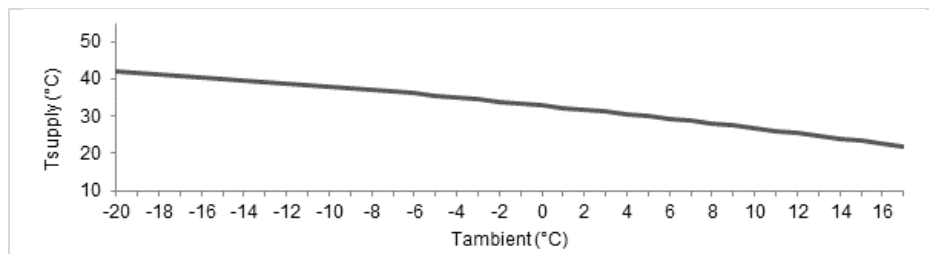

Figure 4 Heating curve. Supply temperature for space heating vs. outdoor temperature.

226

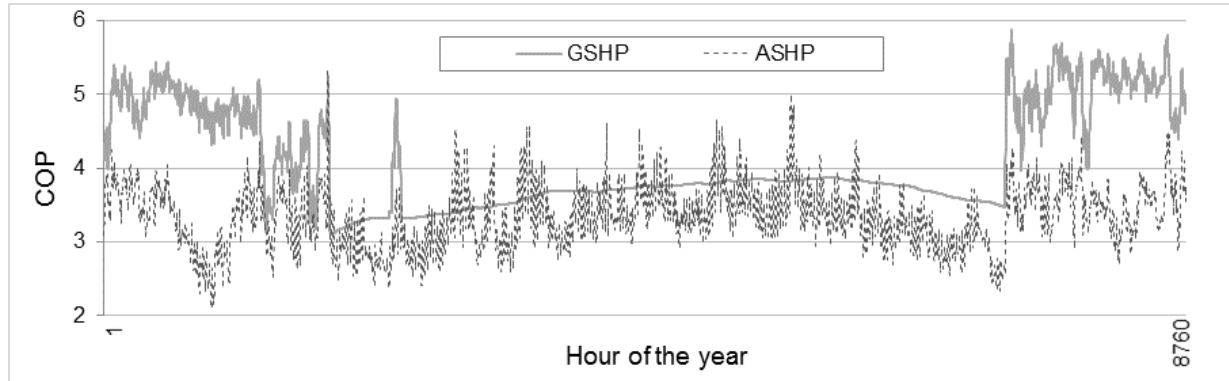

Figure 5 Hourly COP of ground source heat pump (GSHP) and air source heat pump (ASHP) with climatic data for Berlin, Germany in 2012.

227

228 2.2.3 Investment cost of heat storage in energy terms

229 The heat storage is formulated as a single node, serving both DHW and SH demand. As the cost of the
 230 accumulator tank is determined by the volume, given in EUR/liter, the temperatures in the storage is
 231 needed to obtain the cost per heat capacity in EUR/kWh. The conversion factor ε is found by multiplying
 232 the ΔT of the storage tank by the specific volume, ν , density ρ_{water} , and heat capacity C_p , of water as
 233 shown in Eq. (8).

$$\varepsilon = \nu \cdot \rho_{\text{water}} \cdot C_p \cdot \Delta T \quad [\text{kWh/ltr}] \quad (8)$$

234 Hedegaard and Balyk [23], uses a ΔT of 15°C, and argues that this does not reflect the real ΔT of the
 235 storage, but rather how much energy that is available for being utilised by the model. In this case study,
 236 we assume the ΔT to be 30°C, reflecting an average maximum temperature of 60°C, and an average
 237 minimum temperature of 30°C.

238 2.2.4 Solar thermal efficiency

239 The model of the solar thermal collector (ST) presented in [6], takes the temperature of the water from the
 240 collector, $T^{\text{collector}}$, into account. The ST heat is often supplied to the bottom of the storage tank, and thus
 241 the collector temperature is assumed equal to the lower temperature of the storage, 30°C. In real life,
 242 dependent on the control of the system, the temperature from the ST will vary every hour and might reach
 243 up to 90°C in summer. However, a higher value of $T^{\text{collector}}$ decreases module efficiency, and the
 244 assumption of 30°C gives an optimistic value for the efficiency of the ST collector. When investigating
 245 the results in Section 3, ST is not found as an economic optimal technology choice, even with the higher
 246 efficiency, indicating that the 30°C collector temperature is not a limiting factor of the model.

247 2.2.5 Available roof and façade area

248 The findings of the case studies in Noris et.al. [7] show that the available façade and roof area for
 249 installation of ST or PV might be a limiting factor in order to reach the ZEB balance. However, as the
 250 main intention of this paper is to analyse the ZEBs if everything is possible, it is decided to let the
 251 available façade and roof area be without limitations.

252 **2.3 Technology costs and energy prices**

253 This section presents the costs and efficiencies of the energy technologies implemented. The energy
 254 market conditions for Germany is presented through fuel prices, and special electricity tariffs.

255 *2.3.1 Technology costs and efficiencies*

256 A newly built house needs to install energy technologies at the time of construction which fits to its
 257 demand. As the specific technology costs (EUR/kW) are assumed constant, they must be collected for the
 258 appropriate size of the building in question [6]. In this paper, investment costs are collected for heat
 259 technology sizes of 5-10 kW to fit the heat demand found in Section 2.2.1. The minimum capacity of the
 260 boilers, if invested, is set to 5 kW_{th}, which equals 3,2 kW_{el} for the CHP.

261 Table 1 Specific investment costs (EUR/kW), and annual operation and maintenance cost (%) and fixed investment costs (EUR)
 262 for technology sizes of 5-10 kW.

	Specific investment cost		Fixed annual O&M costs (% of inv.costs)	Fixed investment cost		Reference
	EUR/kW _{th}	Description		EUR	Description	
PV	1 800	Module cost (per kWp)	1,0 %	1 000	Mounting and installation	[24]
ST – Solar thermal collector	570	Module cost (per m ²)	1,0 %	4 000	Mounting and installation	[25]
GSHP – Heat pump (liq-water)	770	Unit cost	2,0 %	17 000	Drilling of well, installation and engineering costs	[25]
ASHP – Heat pump (air-water)	1 150	Unit cost	2,0 %	3 000	Mounting and installation	[25], [26]
BB – Bio pellets boiler	610	Unit cost	3,0 %	4 000	Storage/Silo with automatic feeder	[25]
EB – Electric top-up coil	60	Unit cost	2,0 %			[25]
DH – District heating	80	Grid connection	0 %	4 000	Connection to district heating grid	[25], [26]
GB – Gas boiler	600	Unit cost	1,5 %	1 600	Connection to gas grid	[26]
CHP – Combined Heat & Power	3 400	Unit cost (per kW _{el})	3,0 %	1 600	Connection to gas grid (not active if GB already invested)	[25], [26]
AT – Hot water storage	90	Unit cost (EUR/kWh)	0 %			[25]

263 The efficiencies of the energy technologies are given in Table 2, where the calculated seasonal average
 264 COP is based on the hourly COP in Figure 5. The CHP has a constant relationship between the electricity
 265 and heat efficiency, so if 1 kWh heat is needed, the unit simultaneously generates 0,63 kWh electricity.
 266 The last row of the table shows the hour-by-hour dispersion factor of the heat storage which is not the
 267 same as the seasonal average efficiency of the storage.

268 Table 2 Technology efficiencies.

	Efficiency	Comment	Reference
	[-]		
ASHP – Heat pump (air-water)	3,28	Simulated SCOP	
GSHP – Heat pump (liq-water)	4,45	Simulated SCOP	
BB – Bio pellets boiler	0,90		[27]
EB – Electric top-up	0,98		[28]
DH – District heating	0,98		
GB – Gas boiler	0,96		[29]
CHP – Electric Efficiency	0,33		[29] [30]
CHP – Heat Efficiency	0,52		[29]
AT – Hot water storage	0,99		

269

270 **2.3.2 Electricity tariffs**

271 In Germany, the feed-in tariff (FiT) for roof mounted PV up to 500 kW is about 11 ct/kWh [31], and the
 272 FiT for highly energy efficient CHPs, regardless of fuel, is 5,4 ct/kWh [32]. Currently, the FiT for PV is
 273 being replaced by a market premium model, depending on the actual price of electricity in the EEX-
 274 market each hour instead of a fixed feed-in. Even though the income varies from hour to hour, the overall
 275 income for the building owner should be more or less unchanged [33]. Therefore, for simplicity reasons,
 276 the selling price of PV electricity, is set equal to the FiTPV which is constant for all hours. Due to the
 277 current resistance to the EEG-tax in Germany, on-site electricity generation directly self-consumed by the
 278 building must pay 30 % of the EEG-tax, which equals 1,85 ct/kWh [33].

279 **2.3.3 Fuel prices**

280 Representative fuel prices are based on current offered contracts in Germany. The contracts for fuels
 281 attached to a distribution grid have a fixed annual charge and a specific energy charge, as shown in Table
 282 3. Notice that the price for electricity used for heat pumps is 5 ct/kWh lower compared to the general
 283 electricity price [34].

284 Table 3 Fuel prices for end-users. Energy prices [EURcent/kWh] and fixed annual grid charges [EUR/yr]

Energy carrier	Category	Energy price cent/kWh	Fixed annual charge EUR/yr	Reference
Bio pellets		6,0		[35]
GAS	Gas distribution grid	5,5	170	[36]
DH	District heating grid	7,2	327	[37]
EL	Import price from electricity grid	24,1	140	[38] [34]
EL	Import price HP electricity	19,0		[34]
EL	Export price PV electr (FiTPV)	10,8		[31] [34]
EL	Export price CHP electr (PiTCHP)	5,4		[32] [34]
EL	Self-consumption (30 % of EEG-tax)	1,9		[33]

285

286 **2.4 Weighting factors – PE and CO₂**

287 Table 4 shows weighting factors used for calculating the ZEB balance. The CO₂ factors are according to
 288 IEA [39], and primary energy factors are according to the EPBD. The *non-renewable* primary energy
 289 factors (PEnr) reflect the amount of non-renewable energy required to attain 1 kWh of the respective
 290 energy carrier, whereas the *total* primary energy factors (PEtot) reflect the total use of energy, both
 291 renewable, fossil and nuclear, per kWh. Comparing PEnr and PEtot, the major difference occur for
 292 bioenergy which increases by 1. Another alternative of the PE factor is to apply asymmetric factors to
 293 electricity, which value exported electricity less than imported electricity, in order to increase the
 294 incentive for self-consuming on-site generated electricity.

295 Table 4 Weighting factors (Primary Energy [2] , and CO₂ [39]).

	CO ₂	Primary Energy (PE)			
		Non-renewable PE		Total PE	
	CO ₂	PEnr-sym	PEnr-asym	PEtot-sym	PEtot-asym
Metric (unit of measure)	g _{CO2-eq} /kWh	kWh _{PEnr} /kWh	kWh _{PEnr} /kWh	kWh _{PEtot} /kWh	kWh _{PEtot} /kWh
Power grid, import	350	2,3	2,3	2,5	2,5
Power grid, export	350	2,3	2,0	2,5	2,0

Wood, pellets	14	0,05	0,05	1,05	1,05
District heat	270 ³	1,3	1,3	1,3	1,3
Natural gas	210	1,05	1,05	1,05	1,05

296

297 **3 Results**

298 In the Introduction, four elements of the ZEB definition was identified. As it is already defined that all
 299 consumed energy is included in the ZEB balance, the first three of these four elements are investigated in
 300 the following; i.e. 1) the metric of the weighting factors, 2) the value of the weighting factors, and 3) the
 301 level of ZEB. The first sub-section investigates the impact on the energy system design of the building,
 302 and the second sub-section analyses the corresponding grid impact.

303 **3.1 Energy system design**

304 *3.1.1 Baseline - no ZEB target*

305 For comparison, we first investigate which solution people would choose if only minimising costs without
 306 posing the ZEB restriction. Figure 6 shows that the most economic way to serve the passive building with
 307 energy, is to install a micro CHP unit of 3,5 kW_{el} which provides both heat and electricity. To cover peak
 308 heat demand, a gas boiler, an electric top-up coil and a heat storage are installed. In addition, it is
 309 profitable to invest in 14 kWp of PV, both because of the FiTPV of 11 ct/kWh, and the saved costs of
 310 imported electricity due to self-consumed PV. Since the roof area of the building is not restricted, this is
 311 an inner optimum. Even without the FiTPV, it is profitable to invest in 7 kWp PV. This supports the claim
 312 that PVs have reached grid-parity in Germany.

313 *3.1.2 'Strictly' ZEB*

314 When the building is to be strictly ZEB, all energy consumed by the building has to be compensated by
 315 on-site energy generation. Figure 6 shows the investment decision when using the CO₂ factors given in
 316 Table 4. CHP is still the most economic way of serving the building with heat and electricity, despite its
 317 high investment cost. There are two reasons for this. First, the alternative cost of electricity for the
 318 building owner at 24 ct/kWh, is far above the gas price at 5,5 ct/kWh. As the CHP unit generates both
 319 0,55 units of heat and 0,33 units of electricity from the same gas unit, the self-generated electricity from
 320 the CHP is highly valued. Secondly, the feed-in tariff for PV compensates for much of the investment cost
 321 of the PV, and thus, reaching the annual net zero balance is met by adding more PV as it constitutes little
 322 additional cost for the building owner. This is confirmed in Figure 6a where the total cost of the 'strictly'
 323 ZEB only increases by 2-4 % compared to *Baseline*. This means that it is profitable to invest in more PV
 324 (46 kWp) to compensate for the weighted energy imports from using natural gas, rather than reducing the
 325 weighted imports to the heat generation itself.

³ Based on a conversion factor of 200 g_{CO2} / kWh_{PE} for district heating obtained from [46].

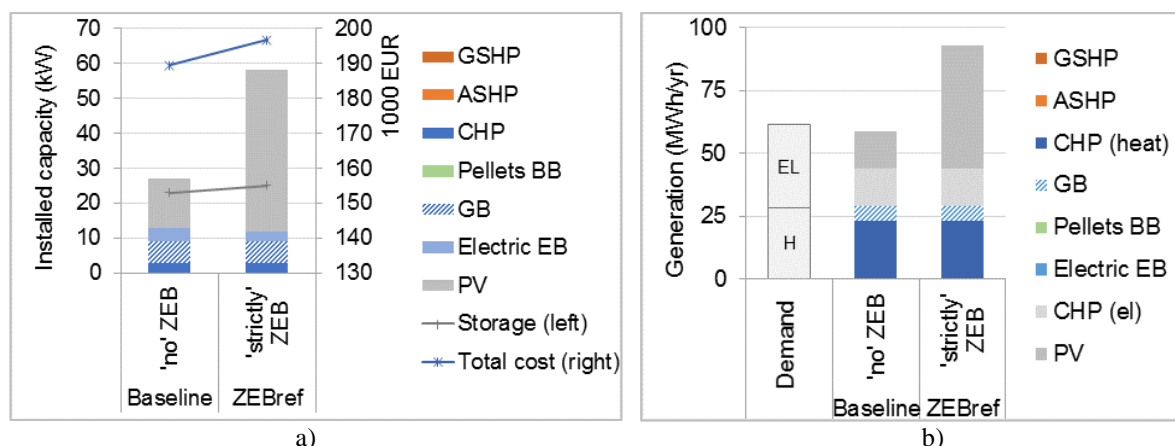

Figure 6 Installed capacity (kW) (a) and annual energy generation (MWh/yr) (b) of a 'strictly' ZEB compared to a Baseline case without any ZEB target.

326

327 The annual energy generated from each of the technologies is shown in Figure 6b, where the CHP unit
 328 provides 79 % of the heat demand and the gas boiler 20 %. The electric top-up coil only contributes with 1
 329 % to cover peak heat demand and is hardly visible in the graph. The installed capacity of the PV is 46
 330 kWp for 'strictly' ZEB case which equals an area of approximately 250 m² if using a conversion factor of
 331 5,3 m²/kWp⁴. Compared to the size of the multi-family house of 1000 m², this could be physically possible
 332 with an adapted architectural design.

333 If using the primary energy factors given in Table 4, instead of the CO₂ weighting factors, the energy
 334 system design remains the same. The only difference when changing the weighting factors is the PV size,
 335 which is determined by the relationship between the weighting factor of electricity export and natural gas
 336 import, given in Table 8. Readers who are interested in the details of these findings, please see Appendix.
 337 Hence, we can conclude that whether the ZEB is a Zero Emission or a Zero Energy Building does not
 338 impact the heat technology choice.

339 When the FiTPV is applied together with the ZEB target, it makes the fossil based heat technology choice
 340 remain unchanged. Due to the FiTPV the ZEB target is met by adding more PV to the building, rather than
 341 reducing the weighted energy imports for heating purposes, by switching to renewable heating, and this is
 342 done without increasing the cost for the building owner significantly.

343 3.1.3 'Nearly' ZEB

344 The ambition level of the ZEB reflects how 'near' to zero the ZEB target is set. Figure 7 shows the
 345 investment results of a 50 % nearly ZEB target when using CO₂ factors. Compared to *Baseline*, the only
 346 difference is found in the size of the PV which is doubled from 14 to 30 kWp. Notice also that the self-
 347 consumption starts at 80 % in *Baseline* and decreases towards 40 % in the 'strictly' ZEB case. This
 348 logically reflects that the more PV that is installed, the smaller amount of the generated PV electricity the
 349 building is able to consume itself.

⁴ This reflects a relatively high module capacity of 300 Wp, which normally has an area of 1,6 m².

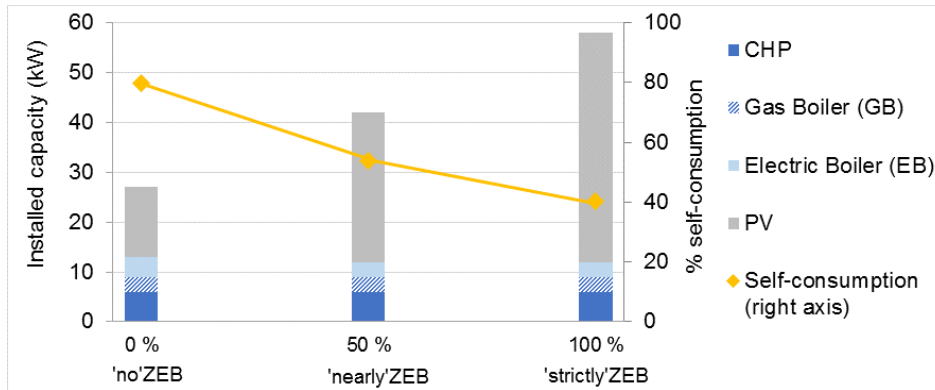

Figure 7 Installed capacity (kW) of a 'nearly' ZEB case. Relaxing the ZEB constraint.

350 As a conclusion, when relaxing the ZEB target aiming at a 'nearly' ZEB, the size of the weighted energy
 351 imports remains unchanged, meaning that the building is still very energy efficient. However, a 'nearly'
 352 ZEB will claim a smaller amount of weighted energy exports, leading to a smaller PV size, which is
 353 important for the grid impact (see Section 4.2).

354 3.2 Grid impact

355 The hourly operation of the building is necessary for understanding its net electric load profile. This
 356 section first investigates the hourly optimal operation of the energy system of the '*strictly*'ZEB, which lies
 357 the basis for understanding the net electric load characteristics of the building.

358 3.2.1 Hourly load characteristics of the '*strictly*' ZEB

359 The hourly operation of the building is best seen by investigating the heat and electricity balances in
 360 parallel. In the following, three consecutive days in summer are analysed. Figure 8 and Figure 9 show the
 361 hourly operation of the building of heat and electricity balances respectively. The black solid lines indicate
 362 the hourly heat or electricity demand of the building, which are inputs to the model.

363 The heat generation in Figure 8 shows that during daytime, the CHP is only run if the heat storage is
 364 empty, and never such that CHP electricity is exported to the grid. This is because the marginal cost of
 365 operating the CHP and the heat storage is higher than the income of selling CHP electricity for export.
 366 When the sun sets and the PV no longer generates electricity (see Figure 9), the CHP unit is run such that
 367 it covers the heat demand and fills up the heat storage, provided that its electricity generation does not
 368 exceed the electricity consumption of the building.

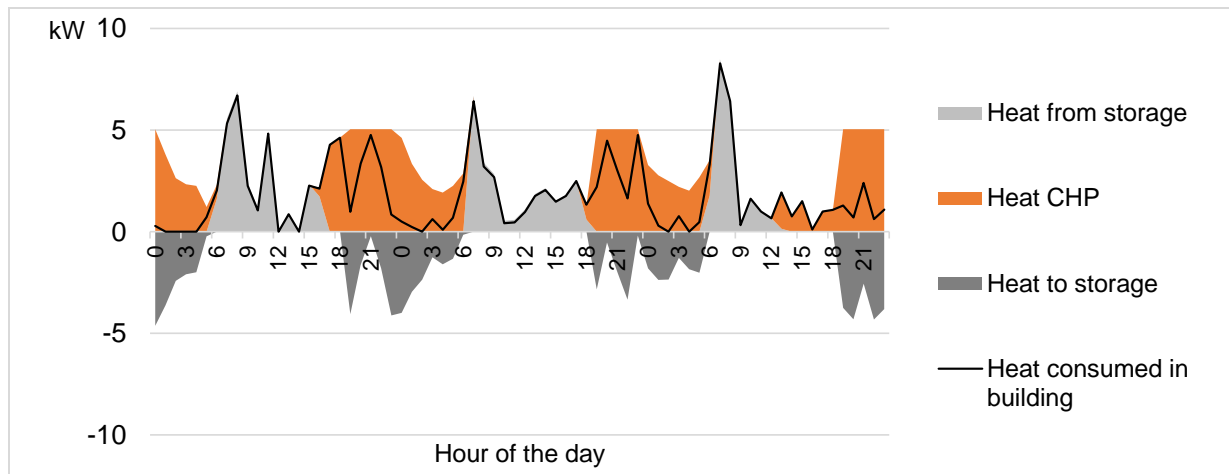

Figure 8 Hourly heat generation (kWh/hr) for the 'strictly' ZEB with CHP, for three days in August (Tuesday – Thursday).

369

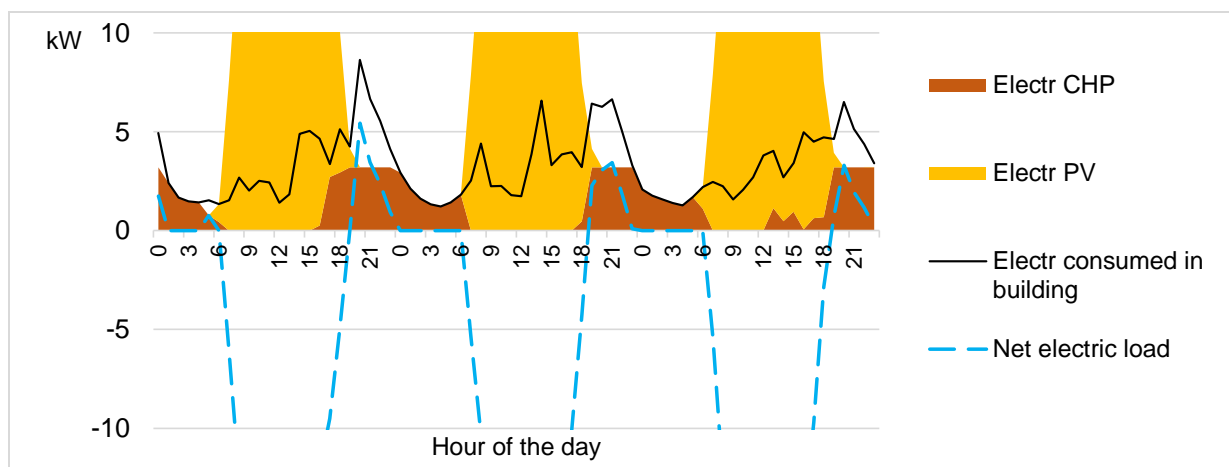

Figure 9 Hourly electricity generation (kWh/hr) for the 'strictly' ZEB with CHP, for three days in August (Tuesday – Thursday). (Notice that the peak values of PV electricity generation and net electric load exceed the borders of the graph).

370

371 The net electric load of the building is the blue dashed line in Figure 9, which shows that electricity is
 372 exported during daytime, reaching maximum values of up to 31,3 kW. In the evening, even though the
 373 CHP is run at its maximum, it is not able to cover the evening peak electricity demands, and thus the
 374 building imports electricity in the late hours from 19hr – 24hr.

375 On the coldest winter day, when heat demand is high, the CHP is operated at maximum load all 24 hours.
 376 The gas boiler (GB) is also run throughout the day, while the electric top-up coil and heat storage is
 377 contributing at peak heat hours. As the CHP unit also runs during daytime, its electricity generation is
 378 added to the PV generation. On a sunny day in February, this may result in export values up to 30,7 kW
 379 because of the relatively low electricity demand of the household during daytime. Consequently, the
 380 maximum electricity export from the building in winter is not very different from the one in summer (see
 381 also Figure 10).

382 3.2.2 Comparing grid impact of 'no', 'nearly' and 'strictly' ZEB

383 When plotted for a whole year, the hourly net electric load profiles for 'strictly' ZEB (equal to the blue
384 dashed line in Figure 9) becomes like shown in Figure 10. For comparison, the Baseline with 'no' ZEB is
385 also plotted. The positive values indicate electricity imports to the building, and negative values export.

386 When sorting the hourly net electric load, we obtain load duration curves as shown in Figure 11. In
387 'no' ZEB, the installed PV size is 14 kWp, which is doubled to 30 kWp in 'nearly' ZEB, and more than
388 tripled to 46 kWp in 'strictly' ZEB. Thus, the largest difference in their net electric load duration curves
389 occurs in the peak export hours, from 9 kW, to 20 kW and 31 kW. The import values, however, are
390 unchanged as the operation of the CHP is not altered. As seen in Table 6, the annual export of electricity is
391 five times higher for the 'strictly' ZEB reference case compared to the Baseline case. Notice that in both
392 cases, the peak export values are lower than the installed PV capacity due to some self-consumption, and
393 to the fact that the PV generation seldom reaches its installed capacity due to inverter efficiency and
394 clouds.

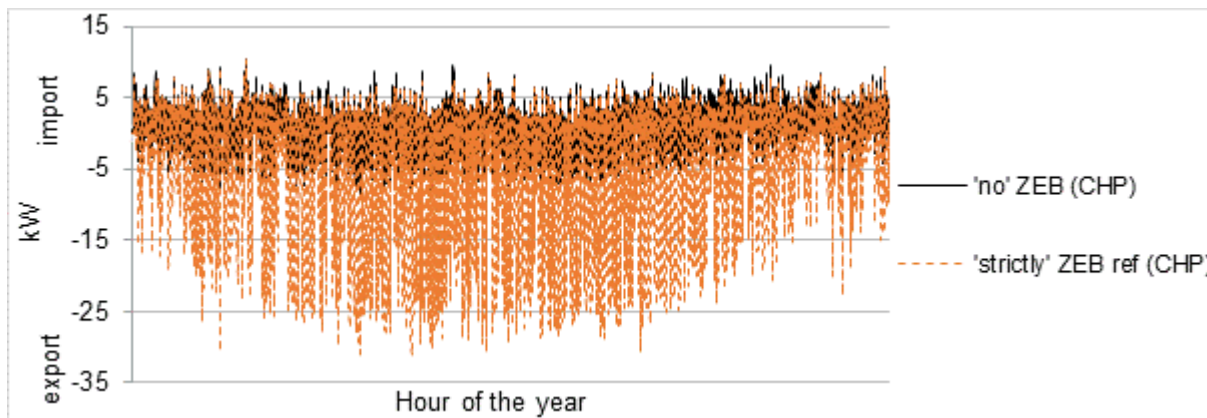

Figure 10 Net electric load profile for baseline ('no' ZEB) and 'strictly' ZEB case, both with CHP serving the base heat load (kWh/hr).

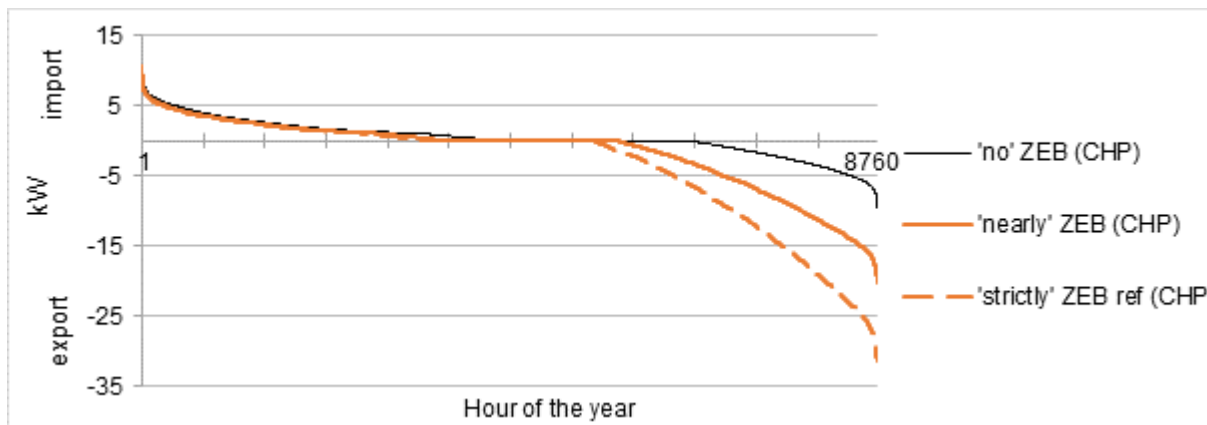

Figure 11 Impact of 'nearly' ZEB on the load duration curves. Comparing Baseline ('no' ZEB) to, 50 % ZEB and 'strictly' ZEB, all with CHP serving the base heat load (kWh/hr).

395 **4 Sensitivity analysis**

396 The first findings show that the optimal technology choice is fossil based, regardless of whether the ZEB
 397 target is Zero Emission or Zero Energy, and whether the ZEB level is ‘nearly’ or ‘strictly’. Section 4.1
 398 investigates how changes of future energy market parameters might alter the optimal energy system design
 399 towards renewable heating choices of a ‘strictly’ ZEB. Whereas Section 4.2 analyses how the energy system
 400 design affects the building’s grid impact. The ‘strictly’ ZEB case from Section 3 is in the following denoted
 401 as *ZEBref*.

402 **4.1 How robust is the choice of CHP?**

403 When looking into the future, several parameters may change from today’s conditions. According to EU’s
 404 energy and climate policy, EU shall have 80 % renewable energy in their electricity production mix within
 405 2050, which will lower the weighting factor for electricity. Further, the electricity price in the power
 406 market is also expected to decrease as the marginal cost of renewable electricity production is close to
 407 zero. Further, the political landscape in Europe could change, and if gas imports are restricted, and/or gas
 408 demand increases, the gas price might increase. The investigated sensitivities are shown in Table 5.

409 Table 5 Investigated future gas price, electricity price and electricity weighting factor.

End-user gas price		End-user electricity price		Feed-in-tariff for PV		Electricity weighting factor	
ct/ kWh	comment	ct/ kWh	comment	ct/ kWh	comment	gCO2/ kWh	comment
6,6	+20%	19,0	-21% Equal to HP tariff	11	Today's FiT for PV	210	Equal to natural gas
8,25	+50%	12,0	-50% Halving the price	5,4	Equal to FiT for CHP electricity	170	Halving today's factor.
		9,6	-60% Similar to end-user prices in Scandinavia.	3,5	No FiT for PV. Export price equal to average EEX power price (2013-2015).	130	Average carbon factor of European electricity for the next 60 years, if the target of 90 % reduction within 2050 is reached [4].
						70	80 % reduction of today's factor.

410

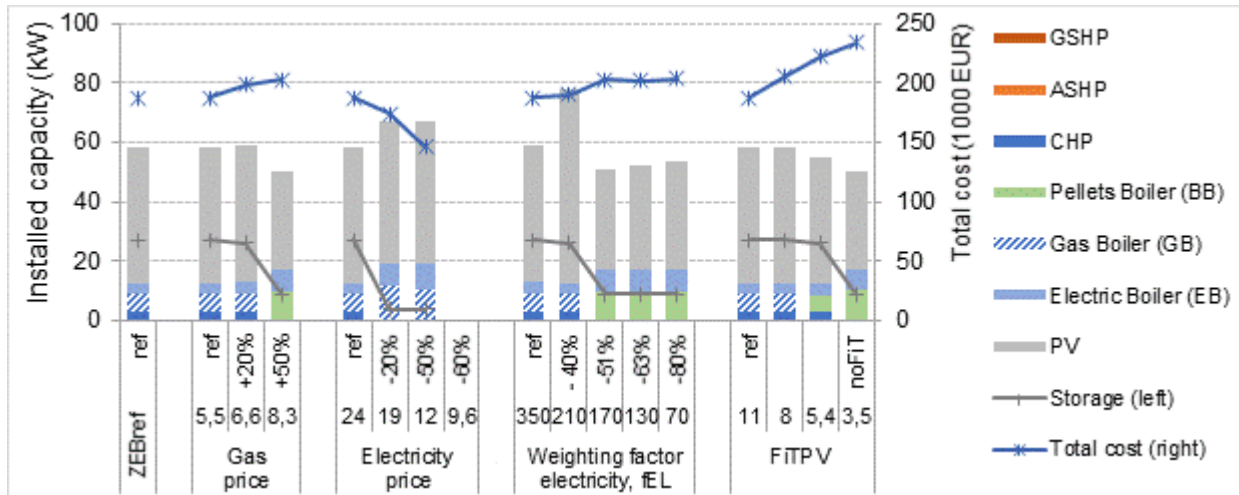

Figure 12 Results of the sensitivity analysis. Influence of higher gas price (ct/kWh), lower electricity price (ct/kWh), reduced weighting factors for electricity (gCO2/kWh) and lower FiT for PV (ct/kWh), on installed capacity (kW) and total discounted cost (1000 EUR).

411 *4.1.1 Higher natural gas price*

412 Figure 12 shows that when the gas price increases by 20 %, the CHP is still a cost optimal choice.
413 Increasing the gas price further, the gas boiler is replaced by a bio pellets boiler. Notice that the PV size is
414 reduced by 31 % because bio energy has a lower weighting factor compared to natural gas, leading to
415 smaller amount of required weighted energy export.

416 *4.1.2 Lower electricity price, P_{EL}*

417 Today's electricity price on the EEX⁵ electricity market is about 3-4 ct/kWh, so the main part of the end-
418 user price of 24 ct/kWh consists of taxes. Even though the market price of electricity might decrease, it is
419 still unclear how the end-user price will evolve because it is mainly influenced by policy makers – it might
420 stay constant, or it could decrease towards levels as in Norway and Sweden. Regardless of the actual
421 development, it is of interest to see how the energy system design would be affected by a lower electricity
422 price.

423 Figure 12 shows that reducing the electricity price from 24 to 19 ct, the electricity generated from the CHP
424 becomes less valuable as the alternative price for electricity from the grid decreases, and thus, the gas
425 boiler is chosen instead of the CHP. Reducing the electricity price further to 12 ct/kWh (also for the HPs),
426 a gas boiler is still the preferred option, but the electric boiler for peak load increases slightly. Reducing
427 the electricity price below the FiTPV to 9,6 cent/kWh, the building gets more paid for PV electricity sold
428 to the grid than what it buys, which is not a realistic option.

429 The electricity price thus only affects the cost-competitiveness of the CHP. Higher electricity price, the
430 more cost-optimal is the CHP. Lower electricity price leads to the next best heat technology choice, which
431 is GB. Notice that the heat pump is still not a viable option due to its relatively high investment costs,
432 even though the fuel costs are low.

433 *4.1.3 Lower electricity weighting factor, f_{EL}*

434 Reduced CO₂ factor for electricity would intuitively lead to less need of installed on-site energy
435 generation (PVs) as the imported electricity is "greener". However, as the findings in Figure 12 show, the
436 opposite effect occurs. The reason lies in the strictly zero restriction, because not only is the imported
437 electricity less polluted, but the exported electricity also displaces less pollution in the grid. In order to
438 compensate for the unchanged amount of imported natural gas, the amount of exported PV electricity
439 increases as the weighting factor for electricity decreases. Because of the FiTPV, the increased PV size
440 influences total cost little, and the preferred heat technology remains unchanged. However at 130 g/kWh_{el},
441 it is necessary to change towards more renewable heat generation, but the heat pump is still not chosen
442 due to its higher investment and fuel costs compared to the bio boiler.

443 *4.1.4 Reduced FiTPV*

444 If the FiT for PV is reduced, Figure 12 shows that the CHP is still the favoured heat technology however,
445 the peak heat load is covered by a BB instead of a GB. Also notice that the total cost has increased as
446 expected, because of the lower income from the exported PV. When removing the FiT for PV, the
447 building owners may sell their PV electricity in the electricity market, which was about 3-4 ct/kWh in
448 2012-2015 [40]. Without the FiTPV, the PV installation becomes more expensive and it is necessary to

⁵ EEX – European Energy Exchange AG www.eex.com/en/

449 reduce the emissions from the heat generation, and a BB is chosen for both peak and base load heat
 450 demand.

451 The FiT is introduced to give incentives for the end-user to invest in local energy generation. However,
 452 when applied together with the ZEB requirement that demands PV in the first place, the FiTPV leads to
 453 lowering the total cost for the building owner. This makes it profitable to use fossil fuels for covering heat
 454 demand, at the cost of higher installed PV and consequently higher electricity exports from the building.
 455 When reducing or removing the FiTPV, the building's possibility of reaching the zero balance becomes
 456 more expensive, and the fossil fuelled heat generation is replaced by a greener alternative, the bio pellets
 457 boiler.

458 4.1.5 Increased RES in the grid - Combining lower f_{EL} and FiTPV

459 When more renewable energy sources (RES) are introduced in the electric power system, most likely the
 460 FiTPV will decrease along with the weighting factor for electricity (f_{EL}). Hence, three model cases
 461 30%RES, 50%RES and 80%RES are developed by combining the two. Figure 14 shows the results.

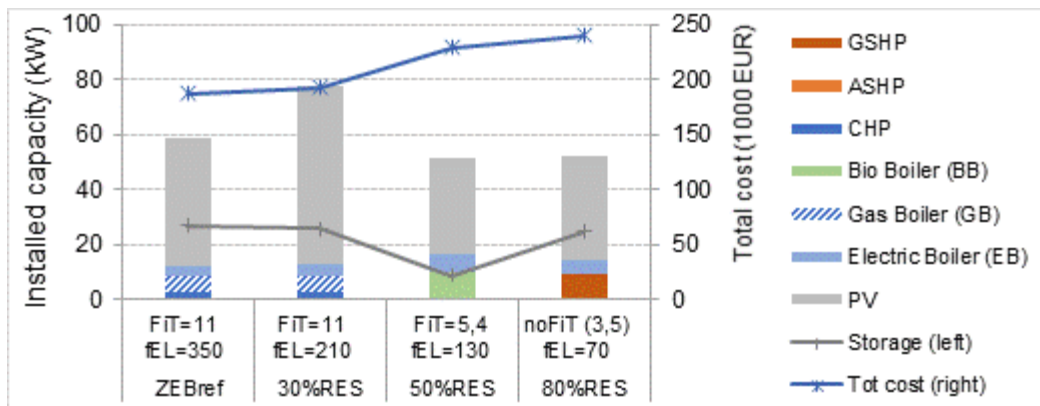

Figure 13 Results of greener electricity production mix. Influence of reduced weighting factors for electricity (f_{EL}), combined with lower FiT for PV (ct/kWh), on installed capacity (kW) and total discounted cost (1000 EUR).

462

463 As found in Section 4.1.3, when the weighting factor, f_{EL} , is reduced (from ZEBref to 30%RES) while
 464 everything else stays constant, this leads to increased PV area, but the heat technology unaffected. As the
 465 FiTPV is unchanged at 11 ct/kWh, the total cost increases with only 3 % even though the PV size is 30 %
 466 larger. In 50%RES, the f_{EL} is reduced further, which contribute to larger PV size and higher costs if not
 467 changing the heat technology. Hence, the heat technology is changed to a BB, and even though the PV
 468 size is reduced, the halved FiTPV and the more expensive BB makes the total cost increase with 22 %,
 469 when compared to ZEBref.

470 When the FiT is removed in 80%RES, together with further decreased weighting factor for electricity, a
 471 HP is installed. Even though the electricity price is unchanged and the technology costs are unchanged,
 472 lowering the weighting factor for electricity to 70 g/kWh and removing the FiTPV makes the heat pump a
 473 cost-optimal choice. The reason is as follows. When the electricity weighting factor is decreased, a ZEB
 474 with BB will need to increase its amount of PV exports. When reducing the FiTPV, the increased PV size
 475 will become more expensive. Reducing one at a time, Figure 12 showed that BB was chosen in both cases.
 476 However, when reducing both the FiTPV and the electricity weighting factor simultaneously, the choice

477 finally becomes HP. Another option is to increase the weighting factor for bio energy, however this is not
 478 investigated in the current work.

479 **4.1.6 Concluding comment on Investment Decision**

480 Because the price of electricity is high compared to the other energy carriers (see Table 3), the benefit of
 481 generating your own electricity makes CHP the favoured heat technology choice.

482 The choice of CHP seems to be very robust when changing each input parameter separately. A lower
 483 electricity price was the only thing that could make the CHP less profitable, as the cost of the electricity
 484 generated from the CHP becomes higher than the price of electricity from the grid.

485 When reducing the FiT and the weighting factor for electricity simultaneously have a larger effect than
 486 lowering the electricity price alone. The sensitivity analysis also shows that the opportunity window for
 487 HP is narrow (see more in Section 5.3).

488 Comparing the technology choices in Figure 12 shows that whenever BB, or CHP, is chosen as main heat
 489 technology, the composition of the other heat technologies in the ZEB building is the same. That is, in the
 490 cases that lead to investment in BB (e.g. higher gas price or lower electricity price), the composition of
 491 installed capacity of the BB, electric boiler, and storage are identical, regardless on what grounds the
 492 choice was made. When the installed capacity is the same, the annual energy consumption is the same,
 493 and the optimal hourly operation is also identical.

494 The findings in Section 3, together with the sensitivity analysis in this section, show two main trends that
 495 are important for the grid impact. 1) once the main heating technology is determined, the hourly heat
 496 operation is identical; and 2) the ZEB level only affects the PV size, which is critical for the grid impact.

497 **4.2 How does the energy system design affect the ZEB's grid impact?**

498 Another finding of the sensitivity analysis in Section 4.1 is that the PV area changes with the choice of
 499 heat technology. From Section 3.2, we know that the PV size is decisive for the grid impact of the ZEB.
 500 Thus, it is interesting to see how the grid impact is affected by the main heat technology choice, while
 501 keeping all other input variables unchanged. Thus, this section analyses the grid impact of a 'strictly' ZEB
 502 with four different main heating technologies; BB, HP, GB and CHP. Their grid impact is further
 503 compared to the grid impact of 'no' ZEB and 'nearly' ZEB from Section 3.1. Table 6 summarises the
 504 findings elaborated on in the following.

505 Table 6 Key performance indicators and grid indicators of investigated ZEB cases.

ZEB level (<i>explanation of case</i>)		'no' ZEB Baseline	'nearly' ZEB 50% ZEB	ZEBref	'strictly' ZEB		
		CHP	CHP	CHP	Gas boiler (GB)	Bio boiler (BB)	Heat pump (GSHP)
Electricity imported (MWh/yr)		8	8	8	20	21	25
Electricity exported (MWh/yr)	PV	6	22	38	37	22	25
	CHP	0	0	0	-	-	-
Electricity generated (MWh/yr)	PV	15	32	49	51	35	41
	CHP	15	15	15	-	-	-
PV installed (kWp)		14	30	46	48	33	38
Self-consumption (MWh/yr)		24	25	26	14	13	16
Self-consumption, total (%)		80 %	54 %	40 %	27 %	37 %	40 %

Self-consumption, PV (%)	60 %	31 %	22 %	27 %	37 %	40 %
Max export value (kWh/hr)	9	20	31	33	22	25
Max import value (kWh/hr)	11	11	11	13	13	18
GM	0,8	1,8	3,0	2,6	1,6	1,4
GMref (ref = 12,6 kW)	0,7	1,6	2,5	2,6	1,7	2,0

506

507 **4.2.1 Net electric load duration curve**

508 Figure 14 shows how the net electric load duration curve is influenced by the main heat technology
509 choice, i.e. GSHP, BB, GB and CHP, for a ‘strictly’ ZEB. The positive part of the load duration curve, i.e.
510 the electricity import, is identical for ZEBs with BB or GB as the operation of the boiler do not influence
511 the electricity imports. A ZEB with CHP has the lowest duration curve for electricity imports. As found
512 in Section 3.2.1, this is because all electricity generated from the CHP is self-consumed, and hence, the
513 net electric import curve is shifted downwards 2-3 kWh/hr compared to a ZEB with a boiler (GB or BB).
514 When using a heat pump, the electricity imports increase, as electricity is also used for heating purposes.
515 However, the net imports of the ZEB with HP in Figure 14 is only 0,5-1 kW higher compared to the
516 boilers. There are two reasons for this; 1) the low heat demand of the building, and 2) the high seasonal
517 COP at 4,5. The largest difference occurs in the peak import value of 18 kW for the HP, which is caused
518 by the electric top-up coil in peak heat hours. As shown in Table 6, the peak import value with HP is about
519 40 % and 70 % higher when compared to a ZEB with a boiler or CHP, respectively.

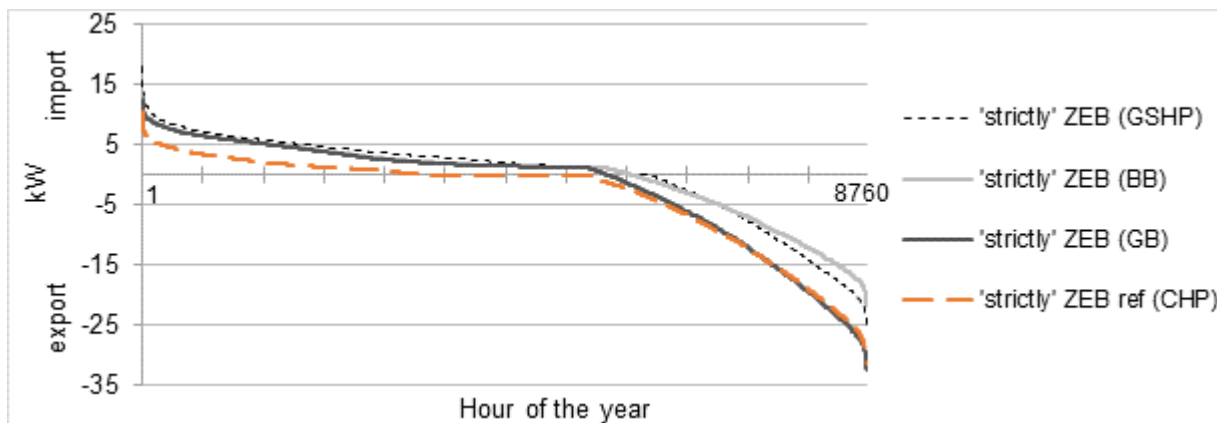

Figure 14 Duration curves of the net electric load for ‘strictly’ ZEBs (kWh/hr). Comparing cases with HP, BB, GB or CHP serving the base heat load, respectively.

520

521 The load duration curve for electricity export is heavily influenced by the size of the PV. Table 6 shows
522 that the fossil fuelled heat technologies require the largest PV size, which is reflected in the peak export
523 values reaching 31 and 33 kW for CHP and GB, respectively. The shape of the duration curve of
524 electricity export is also very similar for these two. The BB has a similar shape, though the export values
525 are smaller. The shape of the HP electricity export differs from all the other heat technologies as it has the
526 least amount of hours with export, but as soon as it starts exporting, the curve becomes steeper, and finally
527 reaching a maximum export value of 25 kW.

528 Lastly, we observe for ZEB with HP, that import values between 50-100 % of the peak import only occurs
529 in 3 % of the hours. This is due to the price structure of electricity in this case study, which do not have a
530 component for maximum load from the grid. This may cause problems for electricity grids with

531 transmission capacity limitations, or for electric power systems with capacity limitations for flexible
532 generation, which hence must provide capacity payment in so-called capacity markets.

533 *4.2.2 Self-consumption*

534 For a ZEB with either GB or BB, the boilers are operated to cover heat demand only, and consequently do
535 not influence the way the building is utilising the electricity grid. Therefore, the self-consumption is only
536 related to how much of the PV that can be utilised for the building's electric specific demand (i.e.
537 appliances, lighting, fans&pumps). Because of the larger PV size of the GB compared to the BB, the self-
538 consumption rate is 27 % with GB and 37 % with BB, even though the amount of self-consumed PV is the
539 same, at 13-14 MWh/yr.

540 A HP on the other hand, can shift its operation to consume PV generated electricity by utilising the heat
541 storage. However, the self-consumption only increases by 3 MWh/yr compared to the BB because the heat
542 demand is low when the sun shines. Even though the amount of self-consumed electricity is higher for the
543 HP case, the share is only 3 %-points higher compared to the BB due to the larger PV generation (41 vs.
544 36 MWh/yr).

545 The highest amount of self-consumed on-site electricity generation, and thus the lowest amount of annual
546 electricity imports of 8 MWh/yr, is found when CHP is the main heating technology. In Section 3.2.1, the
547 CHP was found to be operated such that all the on-site CHP generated electricity is self-consumed. This is
548 confirmed in Table 6 where no CHP electricity is exported to the grid, and the self-consumption at 26
549 MWh/yr is twice as high compared to the ZEB with a boiler.

550 *4.2.3 Additional grid connection capacity*

551 The GM-ref is the relation between the peak export and a reference peak import value, and reflects the
552 need for additional grid connection capacity for the building compared to a reference building without on-
553 site electricity generation. Table 6 shows that the GB and the CHP in theory demands 2,5 higher grid
554 connection capacity, whereas the BB demands 70 % more.

555 *4.2.4 Concluding comment on Grid Impact*

556 From the findings above, we may conclude that the CHP and GB have the highest peak export value, the
557 HP somewhat lower, and the BB the lowest export value. It is surprising that even though the CHP has the
558 highest self-consumption, the peak export value is still one of the highest. The reason lies in the use of
559 natural gas which demands a large PV area. The maximum export value occurs in summer when heat
560 demand is low, and therefore, is determined by the PV size alone. If bio gas had been used in the CHP, the
561 PV size would have been smaller, and thus, the CHP case would have had the lowest export value and the
562 highest self-consumption rate, i.e. the lowest grid-impact.

563 **5 Discussions**

564 The results of this study are dependent on the assumptions made, especially regarding the level of ZEB,
565 the value of the weighting factors, fuel prices and cost of the available technologies. However, there are
566 some general characteristics of ZEBs that become evident from the investigated cases in this paper.

567 **5.1 PV size**

568 The findings in this paper reveals three elements of the PV size in ZEB buildings: 1) A minimum PV size
569 is determined by the electricity specific demand, regardless of the electricity weighting factor, and 2) The
570 total PV size is determined by a) the ZEB-level and b) the weighting factor of the electricity grid.

571 Electric specific demand of the building is present 24 hrs a day, also when the sun is not shining, and thus
572 a minimum amount of imported electricity to the building is always required. This means that the building
573 needs to export at least the equal amount of electricity, regardless of the weighting factor, as long as it is >
574 0. Therefore, a ZEB needs a minimum PV size, only determined by the electric specific demand,
575 regardless of PV cost nor the weighting factor of electricity. In this case study, this minimum PV size is
576 about 30 kWp. When compared to the four ‘strictly’ ZEB cases in Table 6, the additional heat determined
577 PV size ranges from 3-18 kWp, dependent on fuel. Thus, it is evident that the electric specific demand
578 dominates the determination of the PV size.

579 Whether the building is a ‘nearly’ or ‘strictly’ ZEB, is directly reflected in the PV size. Here, the
580 ‘nearly’ ZEB has 35 % smaller PV size compared to the ‘strictly’ ZEB (see Figure 6 and Table 6).

581 The sensitivity analysis of the weighting factor of electricity revealed another aspect of the PV size. If the
582 heat technology is a CHP, a greener electricity grid (i.e. lower factor of electricity) claims a larger PV
583 size. As the exported PV must compensate for the amount of weighted gas imports (which is unchanged),
584 a lower weighting factor of electricity reduces the value of the weighted exported electricity. Hence, the
585 amount of electricity export has to increase in order to reach the zero target. The same applies for ZEBs
586 with other heating technologies. The exemption is HPs, where the weighting factor does not influence the
587 PV size at all as it is an all-electric building.

588 **5.2 Storage size dependent on heat technology**

589 Investigations of the hourly operation reveals that the storage size of the boilers (GB and BB), depends on
590 the peak heat load in winter, and the cost of the base load technology. The gas boiler has a relatively low
591 investment cost, thus the size of the GB is high, whereas the storage size is small. The bio boiler have
592 higher investment cost, leading to larger peak load unit and larger storage size. However, when heat
593 pumps or CHP is chosen, the storage size is larger as the storage is sized for summer conditions. In the
594 case of CHP the storage is sized to store heat generated at night time, to cover the morning peak heat
595 demand. The heat pump on the other hand operates during daytime when PV electricity is available, and
596 the storage is dimensioned to cover the heat demand at night. As discussed in Section 2.2.3, the size of the
597 heat storage should be used with care, as they rely on an assumption of $\Delta T = 30^{\circ}\text{C}$.

598 Table 7 Storage size of strictly ZEBs by main heating technology.

ZEB level	‘strictly’ ZEB			
Main heating technology	CHP	Gas boiler (GB)	Bio boiler (BB)	Heat pump (GSHP)
Storage size (kWh)	25	4	9	14

599

600 It can also be mentioned that a seasonal heat storage was never an economically beneficial decision,
601 regardless of storage efficiency. A seasonal storage would enable PV electricity being stored as heat in
602 summer and used for heat demand in winter. However, as the building must export electricity to reach its
603 annual zero requirement, there is no benefit of storing heat seasonally.

604 **5.3 Heat pump opportunity in ZEBs**

605 When the electricity grid becomes greener in near future, many studies expect that heat pumps will replace
606 fossil fuelled heating [23], [41]–[44]. A lower electricity weighting factor should intuitively lead to HP
607 investments. However, because the investment cost and operational cost of the HP is more expensive than
608 the BB, the sensitivity analysis shows that both the FiTPV and the weighting factor for electricity must be
609 reduced substantially to make the HP a cost-optimal choice over a BB.

610 When moving from fossil fuelled to renewable heat for the ZEB building, the BB is a more cost-efficient
611 choice compared to the HP. Even reducing the electricity price did not affect this solution. The reason lies
612 in the weighting factor of bio energy which demands a smaller PV size compared to the HP. The choice of
613 whether to install HP or BB is thus influenced by 1) the investment and fuel cost of the heat technologies
614 on the one hand, and 2) on the FiTPV and PV installation cost on the other hand, which determines the
615 cost of compensating the weighted energy imports to the building.

616 **5.4 Solar thermal never chosen**

617 For none of the cases investigated, solar thermal (ST) was profitable. In general, using solar thermal (ST)
618 collectors reduces the need for alternative heat generation, which subsequently reduces the weighted
619 energy imports and therefore lowers the required PV investment to balance them off. Thus, the choice of
620 investing in ST is determined by the trade-off of saved fuel costs for alternative heat generation, together
621 with lower investment costs of PV panels, versus the investment costs of ST. As the heating technologies
622 are dimensioned to cover the peak heat load in winter, they are very well capable of also covering the heat
623 demand in summer. Hence, installing ST does not reduce the installed capacity of the heating
624 technologies, but only saves the fuel costs. In order for the ST to be chosen, the specific cost had to be
625 reduced by 75 % to 200 EUR/m², with a size of 14 m². When studying the hourly operation, it is seen that
626 this size fits well with the domestic hot water demand in summer. This confirms the findings in [45] which
627 investigated ways of finding the optimal size of a ST system, and found that cost minimization would lead
628 to no investments in ST at all, and consequently developed an alternative algorithm for sizing of the
629 system. Further, our findings are also in line with [7] which concluded that if available roof area is limited,
630 then it is more beneficial to use it for PV panels compared to ST collectors, despite the higher efficiency
631 of the ST.

632 **5.5 Aspects not considered**

633 The analysis is performed on a single building containing 10 apartments, thus the possible benefits of
634 utilising different energy sources in a local energy system for several buildings is not a part of the present
635 work. Sensitivity analysis of future development of the technology costs is not performed in this paper,
636 even though the modelling framework allows for this. Bio gas is not included in the analysis. If this had
637 been done, dependent on price, the optimal technology might be CHP fuelled by bio gas rather than
638 natural gas. The weighting factor of district heating is quite high for the present European conditions as it
639 is linked to the thermal power plants. As for the weighting factor of electricity, this may change in future.
640 Electric storage can be a viable option with the present support system of batteries in Germany, which will
641 be implemented in future work.

642 **6 Conclusion**

643 This paper identifies the most important factors that influence the grid impact of a ZEB situated in
644 Germany. The analyses are performed using a MILP model which finds the cost-optimal energy system
645 design within the ZEB.

646 We find that whether the building is a ‘nearly’ or ‘strictly’ ZEB building impacts the import/export
647 situation of the building, but it does not affect the choice of energy technologies. The cost-optimal
648 technology mix is thus the same, however the PV size increases by 53 % when going from ‘nearly’ to
649 ‘strictly’ ZEB. This directly affects the grid impact, and the peak export value is increased by 55 % from
650 20 to 31 kW.

651 Whether the ZEB balance is calculated using CO₂ factors (Zero Emission Building) or primary energy
652 factors (Zero Energy Building), the choice and size of energy technologies are not altered. In this case
653 study, a CHP combined with a GB, EB and PV is the cost-optimal technology choice independently of
654 whether the building is a Zero Emission or a Zero Energy Building. The only exemption is the size of the
655 PV, which is determined by the relation between the weighting factor of electricity export and the factor
656 of the other energy carriers. The closer the weighting factor of electricity is to the weighting factor of the
657 other energy carriers, the larger PV size is required to reach the ZEB balance.

658 The choice of whether to use a CHP, GB, BB or HP to cover the base load of the heat demand, is a trade-
659 off between the investment & fuel cost, and the cost of the PV which generates the weighted energy
660 exports. On the one hand, CHP or GB has the lowest costs, but also the highest weighted energy imports,
661 which requires the largest PV size. On the other hand, BB or HP has higher costs, but lower weighted
662 energy imports, leading to smaller PV size (see Table 6). The present FiT of PV in Germany, makes the
663 additional cost of a larger PV size negligible compared to the saved fuel and investment costs by using
664 natural gas for heating. In other words, the choice of heat technologies of a ZEB is dependent on the trade-
665 off between higher costs for renewable heat generation vs. saved costs of smaller required PV size.

666 For ZEBs with HPs or BBs, it is the electric specific demand that dominates the required amount of
667 energy generation, i.e. the PV size. First, because of the relatively low heat demand, and secondly,
668 because the weighting factor of biomass is low and the efficiency of HP is high. In this case study, the PV
669 size determined by the electric specific demand is 30 kW. In the case of the BB or HP, this corresponds to
670 91 and 70 % of the total required PV capacity, respectively.

671 Solar thermal (ST) is not a cost-optimal choice in any of the investigated cases. ST competes with the fuel
672 cost of alternative heating technologies and not with the PV. The only benefits for the ST are the saved
673 fuel costs for heating and the lower PV investment costs, which are not enough to make it economically
674 attractive.

675 Onsite PV installation leads to challenges for the grid in peak hours when the generation exceeds the
676 electricity consumption within the building, creating large export values. A ZEB with fossil fuelled
677 heating technologies requires the largest PV installation, and has consequently higher grid impact. When
678 compared to a ZEB which uses bio fuel, the annual export of electricity to the grid is 73 % higher, the
679 maximum export value is 41% higher, and the self-consumed PV is reduced to about 25 %.

680 In future, the FiT of PV is most likely to be reduced or even removed. When removing the FiTPV, the
681 findings from the sensitivity analysis show that BB is the preferred heat technology. A HP is not a cost-
682 optimal choice until the weighting factor of electricity is reduced by 80 % (equal to 70 g/kWh). Thus,
683 using bio energy for heating purposes seems like a robust technology choice for ZEBs in the future.
684 However, is there enough resources available to cover this demand if all Germany is to be heated by bio
685 energy? Thus, for future policy development, it might be an option to assess a direct investment subsidy,
686 not only for CHPs, but also for heat pumps.

687 One of the main takeaways from this paper is that applying both the ZEB target and the FiTPV lead to
688 fossil fuelled based heating technologies with a large PV area. This contradiction should be addressed
689 when the political definition of ZEB buildings is determined. A mayor concern is also the design of the
690 ZEB definition. There are certain reasons for wanting specific heating technology choices in some
691 countries, and the value of the weighting factors can affect this decision.

692 **Acknowledgements**

693 This work has been supported by the Research Council of Norway and several partners through the
694 Research Centre on Zero Emission Buildings (ZEB) and the Research Centre for Sustainable Energy
695 Studies (CenSES). The authors acknowledge the support from the Norwegian Water Resources and
696 Energy Directorate (NVE) in Oslo, Norway, and Fraunhofer Institute for Solar Energy System (ISE) in
697 Freiburg, Germany. The first and second authors would like to thank Viessmann for providing technology
698 cost data for current market conditions in Germany. The first author would also like to thank Dr. Thomas
699 Erge with the Fraunhofer ISE for valuable input on the current energy market conditions in Germany, and
700 Dr. Torgeir Ericson with the NVE for constructive comments on the structure of the paper.

701 **References**

- 702 [1] European Parliament, "Directive 2010/31/EU on the energy performance of buildings (EPBD) - recast," *Off.*
703 *J. Eur. Union*, no. L153, 2010.
- 704 [2] prEN 15603:2013, "European Standard: draft Overarching standard EPBD," CEN (European Committee for
705 Standardization), Avenue Marnix 17, B-1000 Brussels, 2013.
- 706 [3] I. Sartori, A. Napolitano, and K. Voss, "Net zero energy buildings: A consistent definition framework,"
707 *Energy Build.*, vol. 48, pp. 220–232, May 2012.
- 708 [4] T. H. Dokka, I. Sartori, M. Thyholt, K. Lien, and K. B. Lindberg, "A Norwegian Zero Emission Building
709 Definition," in *Passivhus Norden, The 6th Passive House Conference in the Nordic countries, Göteborg,*
710 *Sweden*, 2013.
- 711 [5] T. Kristjansdottir, H. Fjeldheim, E. Selvig, B. Risholt, B. Time, L. Georges, T. H. Dokka, J. S. Bourrelle, R.
712 Bohne, and Z. Cervenka, "A Norwegian ZEB Definition: Inclusion of embodied emissions," 2014.
- 713 [6] K. B. Lindberg, G. Doorman, D. Fischer, I. Sartori, M. Korpås, and A. Ånestad, "Methodology for optimal
714 energy system design for Zero Energy Buildings using mixed-integer linear programming," *Energy Build.*,
715 vol. submitted, 2015.
- 716 [7] F. Noris, E. Musall, J. Salom, B. Berggren, S. Ø. Jensen, K. B. Lindberg, and I. Sartori, "Implications of
717 Weighting factors on Technology Preference in net Zero Energy Buildings," *Energy Build.*, vol. 82, pp. 250–
718 262, 2014.
- 719 [8] J. Salom, A. J. Marszal, J. A. Candanedo, J. Widén, K. B. Lindberg, and I. Sartori, "Analysis of Load Match
720 and Grid Interaction Indicators in net Zero Energy Buildings with High-Resolution Data," 2014.
- 721 [9] C. Milan, C. Bojesen, and M. P. Nielsen, "A cost optimization model for 100% renewable residential energy
722 supply systems," *Energy*, vol. 48, no. 1, pp. 118–127, Dec. 2012.

- 723 [10] Y. Lu, S. Wang, Y. Zhao, and C. Yan, "Renewable energy system optimization of low/zero energy buildings
724 using single-objective and multi-objective optimization methods," *Energy Build.*, vol. 89, pp. 61–75, 2015.
- 725 [11] M. Hamdy, A. Hasan, and K. Siren, "A multi-stage optimization method for cost-optimal and nearly-zero-
726 energy building solutions in line with the EPBD-recast 2010," *Energy Build.*, vol. 56, pp. 189–203, Jan.
727 2013.
- 728 [12] U. I. Dar, I. Sartori, L. Georges, and V. Novakovic, "Advanced control of heat pumps for improved
729 flexibility of Net-ZEB towards the grid," *Energy Build.*, vol. 69, pp. 74–84, 2014.
- 730 [13] A. Wilson, "The Folly of Building-Integrated Wind," *Environ. Build. News*, vol. 18, no. 5, 2009.
- 731 [14] H. Lund, A. Marszal, and P. Heiselberg, "Zero energy buildings and mismatch compensation factors,"
732 *Energy Build.*, vol. 43, no. 7, pp. 1646–1654, 2011.
- 733 [15] R. Baetens, R. De Coninck, J. Van Roy, B. Verbruggen, J. Driesen, L. Helsen, and D. Saelens, "Assessing
734 electrical bottlenecks at feeder level for residential net zero-energy buildings by integrated system
735 simulation," *Appl. Energy*, vol. 96, pp. 74–83, Aug. 2012.
- 736 [16] A. Zidan and E. F. El-Saadany, "Distribution system reconfiguration for energy loss reduction considering
737 the variability of load and local renewable generation," *Energy*, vol. 59, pp. 698–707, Sep. 2013.
- 738 [17] K. Sperling and B. Möller, "End-use energy savings and district heating expansion in a local renewable
739 energy system – A short-term perspective," *Appl. Energy*, vol. 92, pp. 831–842, Apr. 2012.
- 740 [18] G. Kayo, A. Hasan, and K. Siren, "Energy sharing and matching in different combinations of buildings, CHP
741 capacities and operation strategy," *Energy Build.*, vol. 82, pp. 685–695, Oct. 2014.
- 742 [19] FICO Xpress, "FICO Xpress Optimization Suite." 2014.
- 743 [20] D. Fischer, A. Härtl, and B. Wille-Haussmann, "Model for electric load profiles with high time resolution for
744 German households," *Energy Build.*, vol. 92, pp. 170–179, 2015.
- 745 [21] Eurostat, *Harmonized European Time of Use Survey*. 2000.
- 746 [22] D. Fischer, J. Scherer, A. Haertl, K. B. Lindberg, M. Elci, and B. Wille-Haussmann, "Stochastic Modelling
747 and Simulation of Energy Flows for Residential Areas," in *VDE conference*, 2014.
- 748 [23] K. Hedegaard and O. Balyk, "Energy system investment model incorporating heat pumps with thermal
749 storage in buildings and buffer tanks," *Energy*, vol. 63, pp. 356–365, 2013.
- 750 [24] "Photon no.11/2014," *11/2014*, 2014.
- 751 [25] Viessmann, "Technology Costs," <http://www.viessmann.de/>, 2015. .
- 752 [26] P. Sterchele, "Technisch- ökonomische Analyse von Energiversorgungskonzepten für Gebäude in
753 Deutschland," Master Thesis (Studiengang Regenerative Energiesysteme), Technische Universität Berlin,
754 Institut für Energietechnik, 2014.
- 755 [27] Baunetz Wissen, "Wirkungs- und Nutzungsgrade von Kesseln." [Online]. Available:
756 [http://www.baunetzwissen.de/standardartikel/Heizung_Wirkungs-und-Nutzungsgrade-von-](http://www.baunetzwissen.de/standardartikel/Heizung_Wirkungs-und-Nutzungsgrade-von-Kesseln_161184.html)
757 [Kesseln_161184.html](http://www.baunetzwissen.de/standardartikel/Heizung_Wirkungs-und-Nutzungsgrade-von-Kesseln_161184.html). [Accessed: 11-Jan-2015].
- 758 [28] K. (NVE) Hofstad, *Power and heat production costs for Norwegian conditions*. Norwegian Water Resources
759 and Energy Directorate, Handbook no. 1/2011 (Norwegian title: Kostnader ved produksjon av kraft og
760 varme), 2011.
- 761 [29] H.-M. Henning and A. Palzer, "A comprehensive model for the German electricity and heat sector in a future
762 energy system with a dominant contribution from renewable energy technologies—Part I: Methodology,"
763 *Renew. Sustain. Energy Rev.*, vol. 30, pp. 1003–1018, Feb. 2014.
- 764 [30] IEA ETSAP, "Combined Heat and Power," *IEA ETSAP Technology Brief*, 2010. [Online]. Available:
765 http://www.iea-etsap.org/web/e-techds/pdf/e04-chp-gs-gct_adfinal.pdf. [Accessed: 06-Jun-2014].
- 766 [31] Bundesnetzagentur, "EEG-Fördersätze für PV-Anlagen." [Online]. Available:
767 [http://www.bundesnetzagentur.de/cln_1432/DE/Sachgebiete/ElektrizitaetundGas/Unternehmen_Institutionen](http://www.bundesnetzagentur.de/cln_1432/DE/Sachgebiete/ElektrizitaetundGas/Unternehmen_Institutionen/ErneuerbareEnergien/Photovoltaik/DatenMeldgn_EEG-VergSaetze/DatenMeldgn_EEG-VergSaetze_node.html;jsessionid=AD198A2F218215F6D5938045CBE8C6D0#doc405794bod)
768 [/ErneuerbareEnergien/Photovoltaik/DatenMeldgn_EEG-VergSaetze/DatenMeldgn_EEG-](http://www.bundesnetzagentur.de/cln_1432/DE/Sachgebiete/ElektrizitaetundGas/Unternehmen_Institutionen/ErneuerbareEnergien/Photovoltaik/DatenMeldgn_EEG-VergSaetze/DatenMeldgn_EEG-VergSaetze_node.html;jsessionid=AD198A2F218215F6D5938045CBE8C6D0#doc405794bod)
769 [VergSaetze_node.html;jsessionid=AD198A2F218215F6D5938045CBE8C6D0#doc405794bod](http://www.bundesnetzagentur.de/cln_1432/DE/Sachgebiete/ElektrizitaetundGas/Unternehmen_Institutionen/ErneuerbareEnergien/Photovoltaik/DatenMeldgn_EEG-VergSaetze/DatenMeldgn_EEG-VergSaetze_node.html;jsessionid=AD198A2F218215F6D5938045CBE8C6D0#doc405794bod). [Accessed:
770 20-May-2015].
- 771 [32] Bundesamt für Wirtschaft und Ausfuhrkontrolle, "KWK-Zuschlag," 2015. [Online]. Available:
772 http://www.bafa.de/bafa/de/energie/kraft_waerme_kopplung/stromverguetung/kwk-anlagen_bis_50kw/kwk-

- 773 zuschlag.
- 774 [33] Solaranlagen-Portal, "Förderung für PV-Neuanlagen laut EEG 2014." [Online]. Available:
775 <http://www.solaranlagen-portal.com/photovoltaik/wirtschaftlichkeit/eeg>. [Accessed: 20-May-2015].
- 776 [34] Bundesverband der Energie- und Wasserwirtschaft and (BDEW), "BDEW-Strompreisanalyse Juni 2014.
777 Haushalte und Industri," 2014. [Online]. Available: [https://www.bdew.de/internet.nsf/id/20140702-pi-](https://www.bdew.de/internet.nsf/id/20140702-pi-steuern-und-abgaben-am-strompreis-steigen-weiter-de/$file/140702%20BDEW%20Strompreisanalyse%202014%20Chartsatz.pdf)
778 [steuern-und-abgaben-am-strompreis-steigen-weiter-de/\\$file/140702 BDEW Strompreisanalyse 2014](https://www.bdew.de/internet.nsf/id/20140702-pi-steuern-und-abgaben-am-strompreis-steigen-weiter-de/$file/140702%20BDEW%20Strompreisanalyse%202014%20Chartsatz.pdf)
779 [Chartsatz.pdf](https://www.bdew.de/internet.nsf/id/20140702-pi-steuern-und-abgaben-am-strompreis-steigen-weiter-de/$file/140702%20BDEW%20Strompreisanalyse%202014%20Chartsatz.pdf). [Accessed: 01-Oct-2014].
- 780 [35] RETAXeco GmbH, "Holzpellets." [Online]. Available: [http://retaxeco-px.rtrk.de/2-](http://retaxeco-px.rtrk.de/2-pellets?utm_source=reachlocal&utm_medium=cpc&utm_campaign=verkauf_holzpellets_und_holzbrickets)
781 [pellets?utm_source=reachlocal&utm_medium=cpc&utm_campaign=verkauf_holzpellets_und_holzbrickets](http://retaxeco-px.rtrk.de/2-pellets?utm_source=reachlocal&utm_medium=cpc&utm_campaign=verkauf_holzpellets_und_holzbrickets).
782 [Accessed: 18-Dec-2014].
- 783 [36] Verivox, "Gaspreisvergleich." [Online]. Available: <http://www.verivox.de/>. [Accessed: 26-Nov-2014].
- 784 [37] Stadtwerke Potsdam, "Fernwärmepreise," 2014. [Online]. Available: [https://www.swp-](https://www.swp-potsdam.de/swp/de/energie/angebote-ewp/fernwaerme-ewp/preise-ewp/fernwaerme_1.php)
785 [potsdam.de/swp/de/energie/angebote-ewp/fernwaerme-ewp/preise-ewp/fernwaerme_1.php](https://www.swp-potsdam.de/swp/de/energie/angebote-ewp/fernwaerme-ewp/preise-ewp/fernwaerme_1.php). [Accessed: 21-
786 Oct-2014].
- 787 [38] Verivox, "Strompreisvergleich." [Online]. Available: www.verivox.de. [Accessed: 15-Jan-2015].
- 788 [39] IEA, "CO2 Emissions from Fuel Combustion," International Energy Agency, 2013.
- 789 [40] J. Mayer, "Electricity Production and Spot-Prices in Germany 2014," 2014. [Online]. Available:
790 [https://www.ise.fraunhofer.de/de/downloads/pdf-files/data-nivc-/folien-electricity-spot-prices-and-](https://www.ise.fraunhofer.de/de/downloads/pdf-files/data-nivc-/folien-electricity-spot-prices-and-production-data-in-germany-2014-engl.pdf)
791 [production-data-in-germany-2014-engl.pdf](https://www.ise.fraunhofer.de/de/downloads/pdf-files/data-nivc-/folien-electricity-spot-prices-and-production-data-in-germany-2014-engl.pdf). [Accessed: 23-Oct-2015].
- 792 [41] European Parliament, "Directive 2012/27/EU on energy efficiency," *Off. J. Eur. Union*, vol. L 315, no.
793 October, pp. 1–56, 2012.
- 794 [42] European Commission, "COMMUNICATION FROM THE COMMISSION: Energy efficiency: delivering
795 the 20% target," 2008.
- 796 [43] European Commission, "COMMUNICATION FROM THE COMMISSION: A Roadmap for moving to a
797 competitive low carbon economy in 2050," 2011.
- 798 [44] A. Palzer and H.-M. Henning, "A comprehensive model for the German electricity and heat sector in a future
799 energy system with a dominant contribution from renewable energy technologies – Part II: Results," *Renew.*
800 *Sustain. Energy Rev.*, vol. 30, pp. 1019–1034, Feb. 2014.
- 801 [45] R. Haberl, P. Vogelsanger, and T. Letz, "*Simulation and Optimization Report - MaxLean Concept.*" Report
802 of the IEA SHC programme - Task 32 - Advanced storage concepts, SPF Rapperswil, Switzerland, 2008.
- 803 [46] N. Constantinescu, A. Wallisch, C. Van Stralen, C. Hellmers, E. Piel, H. Ernst, L. Spadoni, M. Blechingberg,
804 and N. Wirgentius, "Guidelines for assessing the efficiency of district heating and district cooling systems,"
805 2006.
- 806
- 807

808 **Appendix**

809 When applying non-renewable primary energy factors (PE_{nr}-sym), Figure 15 shows that the installed
 810 capacity of the CHP, GB, EB and heat storage is the same as when using CO₂ factors. The only difference
 811 is seen in the PV size which is 7 kWp lower. When using the total primary energy factors (PE_{tot}-sym),
 812 where the factor for bio energy is increased from 0,05 to 1,05, there is still no change, as bioenergy is not
 813 a part of the ZEB solution, only that the PV size is 9 kWp smaller.

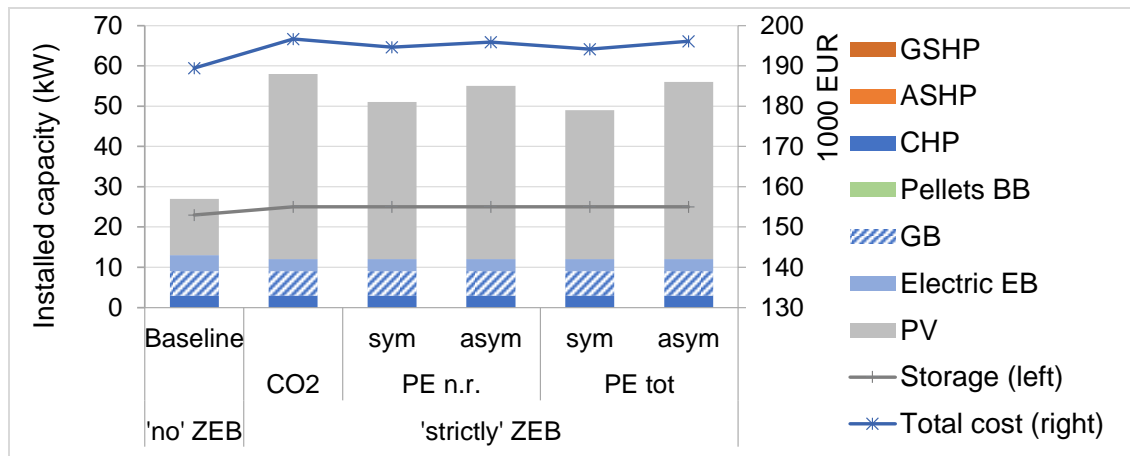

Figure 15 Installed capacity (kW) of ZEBs using different weighting factors; Baseline ('no' ZEB) is compared to a zero emission, zero non-renewable primary energy (symmetric and asymmetric), and zero total primary energy (symmetric and asymmetric) building.

814

815 When applying asymmetric factors for electricity, where export (2,0) is valued less than import (2,3 or
 816 2,5), the incentive for self-consuming on-site PV generation increases. The findings from Figure 6 shows
 817 that the only change from symmetric to asymmetric factors is increased PV area. Due to the optimal
 818 operation strategy of the model, the self-consumption is already maximised, and the imported electricity is
 819 already minimised. By applying the asymmetric factors for electricity, the exported generation is less
 820 valued when calculating the balance, and thus the building needs to export more kWh's in order to reach
 821 the zero balance.

822 Summed up, the only difference when using either CO₂ or primary energy factors, is the size of the PV
 823 system. The PV size is determined by the relationship between the factors of electricity exports and
 824 natural gas imports, given in Table 8. The lower weighting factor of the electricity export is, compared to
 825 the weighting factor of the gas import, the larger amount of annual electricity export is required to
 826 compensate for the energy imports. In Table 8, the CO₂ factors have the smallest difference between the
 827 weighting factor for electricity export and gas import and requires thus the largest PV size, which is
 828 confirmed by the findings in Figure 15.

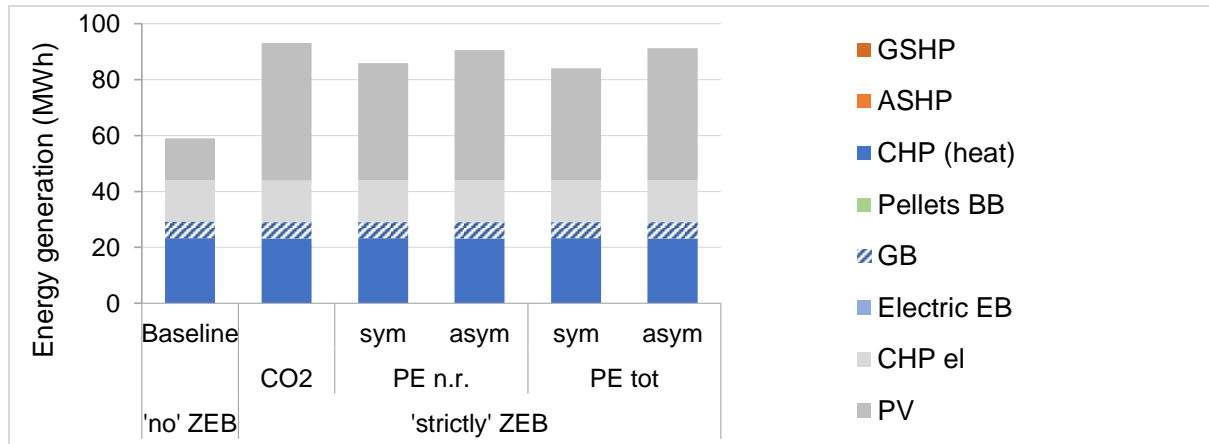

Figure 16 Annual energy generation (MWh/yr) in the baseline case (noZero), compared to when applying five different ZEB targets: zero emission, zero non-renewable primary energy (symmetric and asymmetric), and zero total primary energy (symmetric and asymmetric).

829

830 The annual energy generated from each of the technologies is shown in Figure 16, where the CHP unit
 831 provides 79 % of the heat demand and the gas boiler 20 % regardless of weighting factor. The electric top-
 832 up coil only contributes with 1 % to cover peak heat demand and is hardly visible in the graph.

833 Table 8 Relationship between weighting factors for electricity and natural gas, and between electricity and bio pellets.

Weighting factor	Description	Natural gas vs. Electricity	Bio pellets vs. Electricity
CO2	Zero Emission (using CO ₂ factors)	(210 : 350) Relation 1 : 1,7	(14 : 350) Relation 1 : 25
PE _{n.r.} -sym	Zero Primary Energy (using symmetric non-renewable PE factors)	(1,05 : 2,3) Relation 1 : 2,2	(0,05 : 2,3) Relation 1 : 46
PE _{tot} -sym	Zero Primary Energy (using symmetric total PE factors).	(1,05 : 2,5) Relation 1 : 2,4	(1,05 : 2,5) Relation 1 : 2,4

834

835

836