

# Building Integrated Photovoltaic Products: A State-of-the-Art Review and Future Research Opportunities

Bjørn Petter Jelle<sup>ab\*</sup>, Christer Breivik<sup>b</sup> and Hilde Drolsum Røkenes<sup>b</sup>

<sup>a</sup> Department of Materials and Structures,  
SINTEF Building and Infrastructure, NO-7465 Trondheim, Norway.

<sup>b</sup> Department of Civil and Transport Engineering,  
Norwegian University of Science and Technology (NTNU), NO-7491 Trondheim, Norway.

\* Corresponding author, bjorn.petter.jelle@sintef.no, Phone +47 73 593377, Fax +47 73 593380

## Abstract

Building integrated photovoltaics (BIPVs) are photovoltaic (PV) modules integrated into the building envelope and hence also replacing traditional parts of the building envelope, e.g. the roofing. In this context, the BIPVs integration with the building envelope limits the costs by serving dual purposes. BIPVs have a great advantage compared to non-integrated systems because there is neither need for allocation of land nor stand-alone PV systems. This study seeks to outline various commercially available approaches to BIPVs and thus provides a state-of-the-art review. In addition, possible future research opportunities are explored.

The various categories of BIPVs may be divided into photovoltaic foils, photovoltaic tiles, photovoltaic modules and solar cell glazings. Silicon materials are the most commonly used, and a distinction is made between wafer-based technologies and thin-film technologies. In addition, various non-silicon materials are available. The main options for building integration of PV cells are on sloped roofs, flat roofs and facades. The evaluation of the different BIPV products involves, among others, properties such as solar cell efficiency, open circuit voltage, short circuit current, maximum effect and fill factor.

It is expected that the BIPV systems will improve in the years to come, regarding both device and manufacturing efficiency. The future seems very promising in the BIPV industry, both concerning new technologies, different solutions and the variety of BIPV options.

**Keywords:** *Building integrated photovoltaic, BIPV, State-of-the-art, Review, Future.*

## Contents

<b>1</b>	<b>Introduction .....</b>	<b>3</b>
<b>2</b>	<b>Solar cell concepts .....</b>	<b>4</b>
2.1	Silicon based photovoltaic cells .....	4
2.2	Non-silicon based photovoltaic cells .....	5
2.3	Solar cell production .....	5
2.4	Building integration of photovoltaic cells .....	6
2.5	Architectural aspects of BIPVs .....	6
<b>3</b>	<b>State-of-the-art building integrated photovoltaic products .....</b>	<b>7</b>
3.1	General.....	7
3.2	Building integrated photovoltaic related standards.....	8
3.3	Building integrated photovoltaic products .....	9
3.3.1	BIPV foil products .....	9
3.3.2	BIPV tile products .....	10
3.3.3	BIPV module products.....	10
3.3.4	Solar cell glazing products .....	11
3.3.5	Building attached photovoltaic products.....	12
3.3.6	Comparison .....	13
3.4	Economics .....	13
3.5	Energy payback time for photovoltaic systems.....	15
<b>4</b>	<b>Future research opportunities .....</b>	<b>17</b>
4.1	New materials and solutions for BIPVs.....	17
4.1.1	New materials and technologies.....	17
4.1.2	New solutions.....	19
4.1.3	Further integration of photovoltaic cells.....	21
4.2	Long-term durability of new materials and solutions.....	22
4.3	Visions for the future .....	22
<b>5</b>	<b>Conclusions.....</b>	<b>23</b>
	<b>Acknowledgements.....</b>	<b>24</b>
	<b>References .....</b>	<b>24</b>
	<b>Appendix A – BIPV foil products .....</b>	<b>30</b>
	<b>Appendix B – BIPV tile products .....</b>	<b>31</b>
	<b>Appendix C – BIPV module products.....</b>	<b>34</b>
	<b>Appendix D – Solar cell glazing products.....</b>	<b>41</b>
	<b>Appendix E – BAPV products .....</b>	<b>45</b>

## 1 Introduction

Currently, the world is using fossil fuel at an alarming rate that not only will strain the sources in the near future, but will result in a great amount of pollution as well. The power industry emissions were 10.9 gigatonnes of carbon dioxide equivalents (GtCO<sub>2</sub>e) per year in 2005, i.e. 24% of global Greenhouse Gas (GHG) emissions, and this is expected to increase to 18.7 GtCO<sub>2</sub>e per year in 2030 (McKinsey 2009). “Carbon dioxide equivalent is the unit for emissions that, for a given mixture and amount of greenhouse gas, represents the amount of CO<sub>2</sub> that would have the same global warming potential (GWP) when measured over a specified timescale (generally, 100 years)” (McKinsey 2009).

Of all the renewable energy resources currently available, solar energy is the most abundant, inexhaustible and clean one (Peng et al. 2011). In one day, the irradiation from the sun on the earth gives about 10 000 times more energy than the daily use from all mankind (Swiss BiPV Competence Centre 2010). The challenge is collecting this available energy at a reasonable cost.

One of the most promising renewable energy technologies is photovoltaics. “Photovoltaics (PV) is a truly elegant means of producing electricity on site, directly from the sun, without concern for energy supply or environmental harm” (Strong 2010).

Building integrated photovoltaics (BIPVs) are photovoltaic materials that replace conventional building materials in parts of the building envelopes, such as the roofs or facades. Furthermore, “BIPV are considered a functional part of the building structure, or they are architecturally integrated into the building’s design” (Peng et al. 2011). The BIPV system serves as building envelope material and power generator simultaneously (Strong 2010). BIPVs have a great advantage compared to non-integrated systems because there is neither need for allocation of land nor facilitation of the PV system. Illustrating its importance, BIPVs is given as one of four key factors essential for future success of PV (Raugei and Frankl 2009). The on-site electricity producing PV modules can reduce the total building material costs and achieve significant savings in terms of the mounting costs, especially since BIPVs does not require additional assembly components such as brackets and rails (Neuwald 2011). The BIPV system simply makes electricity out of sunlight, silently with no pollution. All these advantages have caused a worldwide growing interest in BIPV products (Strong 2010).

The purpose of this study is to get an overview of the different BIPV producers and products, and to evaluate which products that are most suitable for different purposes. Furthermore, it is important to know to what extent BIPV products have been tested with respect to long time durability. These investigations may then form the background and backbone for a testing scheme of BIPV products and indicate future research opportunities. This work gives many tables with a lot of information, e.g. manufacturers, product names and various properties, both in the main text and in the appendices. Some of these properties are very important and even crucial to the performance of the various products. Hence, the tables provide the readers with valuable information concerning these products. However, unfortunately it is often hard to obtain all the desired information (e.g. product properties) from all the manufacturers. In general, many property values are often not available at the manufacturers’ websites or other open information channels, which is then seen as open spaces in the tables within this work. Hopefully, our addressing of this fact could act as an incentive for the manufacturers to state all the important properties of their products at their websites and other information channels, and also as an incentive and reminder for the consumers and users to demand these values from the manufacturers.

## 2 Solar cell concepts

The development of building integrated photovoltaic (BIPV) systems follows the development within photovoltaic (PV) cells in general. Hence, some aspects of the PV industry will first be addressed, before moving on to the BIPV technology. The most commonly made solar cells are made from high-grade silicon which is processed with negatively and positively charged semiconductors; phosphorous and boron. When the light energy from the sun hits the photovoltaic cell, electrons are freed to flow from the negative phosphorus to the positive boron. The current produced from the electric potential can be harnessed through a metal grid covering the cell and external circuit.

### 2.1 Silicon based photovoltaic cells

Silicon is the most used material for PV modules. Types of silicon materials for solar cells are monocrystalline, polycrystalline and amorphous silicon. In addition there are ribbon cast polycrystalline cells that are produced from the raw silicon dust wasted producing crystalline silicon wafers. Non-silicon based PV materials are cadmium telluride (CdTe), copper indium diselenide (CIS) and copper indium gallium selenide (CIGS). Figure 1 gives an overview of the different main PV technologies (Raugei and Frankl 2009). Monocrystalline silicon cells are made from pure monocrystalline silicon and have the highest efficiencies, but also slightly higher prices. The colour is usually black or grey. The polycrystalline silicon cells are produced using ingots of multi-crystalline silicon. Due to an easier manufacturing process, the polycrystalline silicon cells are less expensive, but also less effective. They are recognized by the shiny blue colour that comes from the many small crystals. Polycrystallines and monocrystallines form the wafer-based technologies. Amorphous silicon cells consist of a very thin layer of un-crystallized silicon deposited onto a substrate. This makes the cells thinner and amorphous cells are also referred to as thin-film cells. The colour is brownish or reddish brown. Typical efficiencies for monocrystalline cells are 16-24%, and the most efficient monocrystalline modules to date have efficiencies of approximately 20% (Ebong et al. 2010, Green World Investor 2011, SolarPlaza 2011, Yang et al. 2011). For polycrystalline cells the efficiency is typically 14-18% (Green World Investor 2011, Wawer et al. 2011). Amorphous silicon cell efficiencies vary from 4% to 10% (Andresen 2004, Green World Investor 2011, Murphy 2011, The German Energy Society (DGS) 2008). The power per unit area is typically 75-155 Wp/m<sup>2</sup> for monocrystalline and polycrystalline modules, and 40-65 Wp/m<sup>2</sup> for thin-film modules (Swiss BiPV Competence Centre 2010).

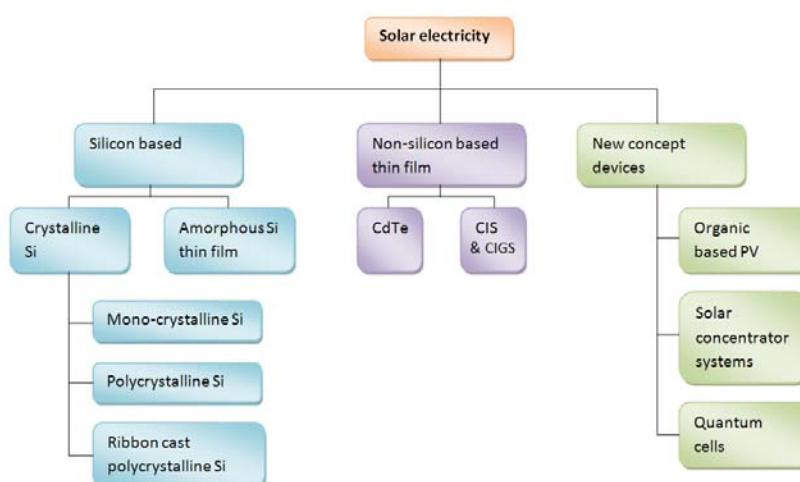

Figure 1: PV technologies. Redrawn from Raugei and Frankl (2009).

## 2.2 Non-silicon based photovoltaic cells

Other thin-film cells in addition to amorphous silicon are: CdTe, CIS and CIGS. Buecheler et al. (2011) names CdTe and CIGS as the most promising technologies for cost-effective decentralized solar electricity production. CdTe solar cells are manufactured on a substrate glass with a transparent conducting oxide (TCO) layer usually made from fluorinated tin oxide (FTO) as the front contact. This is initially coated with an n-type cadmium sulphide (CdS) window layer and secondary with the p-type CdTe absorber layer. CdTe technology has the lowest production costs among the current thin-film modules, and is some of the most promising for wide scale application (Khrypunov et al. 2011). The colour is reflective dark green to black and typical cell efficiencies are 9.4-13.8% (Buecheler et al. 2011, Khrypunov et al. 2011, The German Energy Society (DGS) 2008). CIS and CIGS cells are currently the most effective of the thin-film cells with typical cell efficiencies of 11-18.7% and the colour is dark grey to black (Buecheler et al. 2011, Green World Investor 2011, Ishizuka et al. 2010, Repins et al. 2009, The German Energy Society (DGS) 2008). The most efficient CIS/CIGS modules to date have efficiencies of approximately 13% (SolarPlaza 2011). Values for the highest reported efficiencies of CdTe and CIGS solar cells are shown in figure 2 (Buecheler et al. 2011).

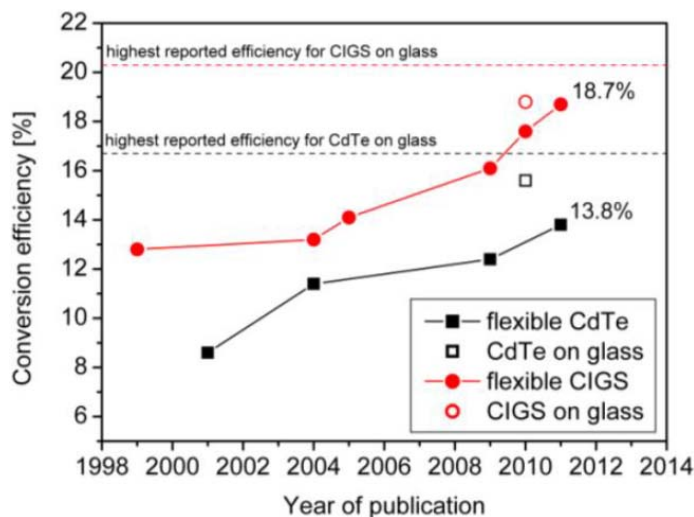

Figure 2: Conversion efficiencies of flexible CdTe and CIGS solar cells fabricated by low temperature processes. Also shown is the in-house reference on glass and the highest reported efficiency for each technology (Buecheler et al. 2011).

## 2.3 Solar cell production

The solar cells are strung together in series to one or more strings of several solar cells. Thin-film materials can be made directly into modules. This is done by sputtering the cell material onto a substrate of glass, polyamide or stainless steel and then it is interconnected by laser to a module. The cells in the PV module are encapsulated between a transparent cover and weatherproof backing. In order to be protected from the external environment, the solar cells are usually laminated with a tempered, low iron-content glass on the front. The glass is inexpensive, strong and stable with high transparency, and it prevents penetration of water, water vapor and gases.

On the rear side there is usually a thin polymer sheet or, if the module is bi-facial or semi-transparency is wanted, glass is used. On each side of the cell there is a layer of ethylvinylacetate (EVA) to provide adhesion. The stability of this encapsulant is one of the major contributors to the durability of the module. To increase strength an aluminum frame is sometimes introduced. Modules can be connected in series to strings and then in parallel to form larger units, arrays. The modules or arrays give power to components transporting and converting the DC electricity into AC electricity.

## 2.4 Building integration of photovoltaic cells

The four main options for building integration of PV cells are on sloped roofs, flat roofs, facades and shading systems. South-facing sloped roofs are usually best suited for PV installation because of the favorable angle with the sun. One option is to mount PV modules above the roofing system. Another option is PV modules that replace conventional building materials in parts of the building envelopes, such as the roofs or facades, i.e. BIPVs. "BIPV are considered a functional part of the building structure, or they are architecturally integrated into the building's design" (Peng et al. 2011). The BIPV system serves as building envelope material and power generator simultaneously (Strong 2010). This can provide savings in materials and labour, and also reduce the electricity costs, but obviously increases the importance of water tightness and durability of the BIPV product.

An elevated temperature in the module decreases the performance of the solar cells, especially for mono- and polycrystalline modules. Therefore, an air gap underneath the module is important to decrease the temperature. The thin-film products, on the other hand, perform more independently of the temperature.

For flat roofs there are three options: (1) modules mechanically fixed to the roof structure, (2) based on weight foundation and (3) an integrated solution. Depending on the geographical position of the structure, the PV modules might have to be inclined. This is more difficult with integrated solutions. The integrated systems can include the properties of one roofing element or several. Lack of air flow underneath the module can be a challenge (in order to decrease the temperature). The use of PV in the facade can replace a glass or tile skin. Geographic position plays an important role when planning the use of photovoltaic cells in facades, and the output is higher on northern and southern latitudes. The two main categories are ventilated and non-ventilated facades. The category sets the criteria for the choice of solar cell material.

The area to be covered by PV modules varies from case to case. In general, areas that are shaded for the majority of the day should be avoided. If the project is subsidized, the subsidies might be given for a certain level of power produced, and therefore the size of the PV-covered area may depend upon this. This can lead to solutions with only a few spread PV modules, and therefore some producers offer dummy modules to provide a more aesthetical and consistent look for the roof or facade.

## 2.5 Architectural aspects of BIPVs

BIPV systems provide many opportunities for innovative architectural design and can be aesthetically appealing. BIPVs can act as shading devices and also form semi-transparent elements of fenestration (Jelle et al. 2012a, Norton et al. 2011). Amorphous silicon tiles can be used to make a BIPV roof look very much like a standard tiled roof (as shown in figure 3), while on the other hand semi-transparent modules can be used in facades or glass ceilings to create different visual effects (as shown in figure 4). Some architects enjoy presenting a BIPV roof as a roof giving a clear visual impression, while others want the BIPV roof to look as much as a standard roof as possible.



Figure 3: Curved clay looking solar tiles (Solar Thermal Magazine 2010).



Figure 4: Glass ceiling with transparent BIPV modules (Global Energy Network Institute 2009).

### 3 State-of-the-art building integrated photovoltaic products

#### 3.1 General

The evaluation of the different BIPV products may involve the following property parameters:

- Solar cell efficiency  $\eta = P_{\max}/(EA)$ , where  $P_{\max}$  is the maximum power point,  $E$  is the input light irradiance in  $W/m^2$  and  $A$  is the surface area of the solar cell in  $m^2$
- Open circuit potential or voltage  $U_{oc}$
- Short circuit electrical current  $I_{sc}$
- Maximum power point  $P_{\max}=(UI)_{\max}$
- Fill factor  $FF$  given by:  $FF = P_{\max}/(U_{oc}I_{sc}) = (UI)_{\max}/(U_{oc}I_{sc})$
- Band gap  $E_g$
- Quantum yield  $\phi = \text{\#photo-electrons} / \text{\#photons}$

The values are achieved by the manufacturers using mainly Standard Test Conditions (STC) and also Nominal Operating Cell Temperature (NOCT).

The air mass (AM) determines the radiation impact and the spectral combination of the light arriving on the surface of the earth (Eotec Energy 2011). The air mass coefficient is given by:  $AM = L/L_0 \approx 1/(\cos z)$ , where  $L$  is the path length through the atmosphere for solar radiation at angle  $z$  relative to the normal to the earth's surface,  $L_0$  is the zenith path length (i.e. normal to the earth's surface) and  $z$  is the zenith angle in degrees (Würfel 2005).

The Standard Test Conditions (STC) and the Nominal Operating Cell Temperature (NOCT) test conditions are given in table 1.

**Table 1: STC and NOCT test conditions.**

	Irradiance (W/m <sup>2</sup> )	Temperature of PV cell (°C)	Ambient air temperature (°C)	Solar radiation distribution	Wind speed (m/s)
STC	1000	25	-	AM1.5	-
NOCT	800	-	20	-	1

### 3.2 Building integrated photovoltaic related standards

The European Standard EN 61646 "Thin-film terrestrial photovoltaic (PV) modules - Design qualification and type approval" gives detailed test procedures for PV modules. It is equal to International Standard IEC 61646. The procedures consist of: (1) visual inspection, (2) maximum power determination, (3) insulation test, (4) measurements of temperature coefficients, (5) measurement of NOCT, (6) performance at STC and NOCT, (7) performance at low irradiance, (8) outdoor exposure test, (9) hot-spot endurance test, (10) UV preconditioning test, (11) thermal cycling test, (12) humidity-freeze test, (13) damp heat test, (14) robustness of terminations test, (15) wet leakage current test, (16) mechanical load test, (17) hail test, (18) bypass diode thermal test, (19) light-soaking (European Comitee for Electrotechnical Standarization 2008). EN 61215, equal to IEC 61215, "Crystalline silicon terrestrial photovoltaic (PV) modules - Design qualification and type approval" includes the same tests as EN 61646 with one exception: light-soaking (European Comitee for Electrotechnical Standarization 2005).

The EN 61730 gives the photovoltaic (PV) module safety qualification. Part 1 gives the requirements for construction while the content of part 2 is the requirements for testing. The procedures are: (1) visual inspection MST 01, (2) accessibility test MST 11, (3) cut susceptibility test MST 12, (4) ground continuity test MST 13, (5) impulse voltage test MST 14, (6) dielectric withstand test MST 16, (7) temperature test MST 21, (8) fire test, (9) reverse current overload test MST 26, (10) module breakage test MST 32 (European Comitee for Electrotechnical Standarization 2007a, 2007b).

The procedures of the standards can be similar, but as described above they apply for the various cases of thin-film, crystalline silicon and module safety.

The manufacturers from USA relate to the standard UL 1703 "UL Standard for Safety Flat-Plate Photovoltaic Modules and Panels". It includes both the construction and the performance of the PV module. The tests procedures given are: (1) temperature test, (2) voltage, current and power



measurements tests, (3) leakage current test, (4) strain relief test, (5) push test, (6) cut test, (7) bonding path resistance test, (8) dielectric voltage-withstand test, (9) wet insulation-resistance test, (10) reverse current overload test, (11) terminal torque test, (12) impact test, (13) fire test, (14) water spray test, (15) accelerated ageing test, (16) temperature cycling test, (17) humidity test, (18) corrosive atmosphere test, (18) metal coating thickness test, (19) hot-spot endurance test, (20) arcing test, (21) mechanical loading test and (22) wiring compartment securement test (Underwriters Laboratories Inc. 2002). This standard describes more test procedures than the European standards and might therefore seem more thorough.

### 3.3 Building integrated photovoltaic products

There is a wide range of different BIPV products which can be categorized in different ways. In this work the categorization is mainly based on how the manufacturer describes the product, and what other type of material the product is customized to be combined with. The product categories considered are foils, tiles, modules and solar cell glazing products. The modules can normally be used with various kinds of roofing material. The solar cell glazing products can be integrated in the facade, roof or in fenestration products, e.g. windows, and provide various aesthetic solutions. Some products hold a variety of properties, thus making it more difficult to categorize them. This study has been carried out on a variety of products and the tables in Appendix A to Appendix D denote a representative selection of state-of-the-art BIPV products. This study is limited to BIPVs. Nevertheless, in Appendix E there are given building attached photovoltaic (BAPV) products that are not BIPVs, or it is uncertainty regarding how the product is mounted. Peng et al. (2011) refers to BAPV as an add-on to the building, thus not directly related to the structure's functional aspects.

#### 3.3.1 BIPV foil products

The BIPV foil products are lightweight and flexible, which is ideal for easy installation and the weight constraints most roofs have. The photovoltaic cells are often made from thin-film cells to maintain the flexibility in the foil and the efficiency regarding high temperatures for use on non-ventilated roof solutions. Unfortunately, there are few producers on the market that provide weather tight solutions. Table 2 presents an example of one foil product, showing the open circuit potential/voltage  $U_{oc}$ , short circuit current  $I_{sc}$ , maximum power point  $P_{max}$  and the fill factor FF. A full table containing more information can be found in Appendix A.

**Table 2: Literature data for one of the BIPV foil products (references and further details given in Appendix A).**

Manufacturer	Product*	$\eta$ [%]	$U_{oc}$ [V]	$I_{sc}$ [A]	$P_{max}$ [W]	FF	Area [mm x mm]	$P_{max}/area$ [W/m <sup>2</sup> ]	Material
Alwitra GmbH & Co.	Evalon V Solar 408		138.6	5.1	408 /module	0.58	1550 x 6000	42.9	Amorphous silicon cells
	Evalon V Solar 136		46.2	5.1	136 /module	0.58	1050 x 3360	38.5	

\*Several models are available from the producer in the Evalon V Solar series.

The fill factor is low for photovoltaic foil products due to both the low efficiency and the large solar cell resistances of thin-film cells, in this case amorphous silicon cells. However, it is possible to vary the degree of inclination of the product to a great extent providing flexible solutions. The foil product uses the PV laminates from Uni-Solar and is tested and approved according to, amongst others, EN 61646 and EN 61730 (European Comitee for Electrotechnical Standarization 2007a, 2007b, 2008).

### 3.3.2 BIPV tile products

The BIPV tile products can cover the entire roof or just parts of the roof. They are normally arranged in modules with the appearance and properties of standard roof tiles and substitute a certain number of tiles. This is a good option for retrofitting of roofs. The cell type and tile shape varies. Some tile products resemble curved ceramic tiles (see figure 3 in section 2.5) and will not be as area effective due to the curved surface area, but may be more aesthetically pleasing. Table 3 gives examples of four photovoltaic tile products that are on the market today.

**Table 3: Literature data for some of the BIPV tile products (references and further details given in Appendix B).**

Manufacturer	Product*	$\eta$ [%]	$U_{oc}$ [V]	$I_{sc}$ [A]	$P_{max}$ [W]	FF	Area [mm x mm]	$P_{max}/area$ [W/m <sup>2</sup> ]	Material
Solar-dachstein	STEP-design		23.15	2.40	1.36 /cell	0.76	8 units 100 x 100	136	Poly-crystalline silicon cells
SRS Energy	Solé Powertile		6.3	4.6	15.75 /module	0.54	868 x 457.2	39.7	Amorphous silicon cells from Uni-Solar
Lumeta	Solar Flat Tile		7.4	5.2	28 /module	0.73	432 x 905	71.6	Mono-crystalline silicon cells
Solar Century	C21e Tile	20 /cell	12.0	5.55	52 /module	0.78	1220 x 420	101.5	Mono-crystalline cells

\*Lumeta has also a Solar S Tile available.

STEPdesign, Solar Flat Tile and C21e Tile (table 3) provide the highest FFs indicating that the efficiencies are high. In fact, Solar Century reports an efficiency of 20% per cell for their C21e Tile. The design concept of the STEPdesign and the Solé Powertile is; one module appearing as standard roof tiles that displaces several standard roof tiles. The module has an integrated panel of poly- or monocrystalline cells. This means that parts of the module are not covered with photovoltaic cells, and therefore the total area efficiency will not be as high as indicated. The solution from Solardachstein can be mounted on several different tile products. C21e Tile has a larger active area than the previous products since monocrystalline silicon cells cover the entire module area. It is compatible with a series of named tiles and slates. Solé Powertile has a design much like standard roof tiles and the amorphous silicon cell cover from Uni-Solar acts as the skin of the tiles. Solardachstein's STEPdesign is approved according to EN 61215, while Lumeta's and Solar Century's products are certified with EN 61215 and EN 61730 (European Committee for Electrotechnical Standardization 2005, 2007a, 2007b). For further details see Appendix B.

### 3.3.3 BIPV module products

The BIPV module products presented are somewhat similar to conventional PV modules. The difference, however, is that they are made with weather skin solutions. Some of the products can replace different types of roofing, or they fit with a specific roof solution produced by its manufacturer, e.g. Rheinzink's "Solar PV Click Roll Cap System" (Rheinzink 2011). These mounting systems increase the ease of installation. There is a large amount of products on the market and some of them are promoted as BIPV products without functioning as weather skin. Other products are not very specific on how they are mounted which leads to uncertainty whether they are BIPVs or

BAPVs. Some of the products in this category are premade modules with insulation or other elements included in the body. Table 4 gives examples of BIPV module products.

**Table 4: Literature data for some of the BIPV module products (references and further details given in Appendix C).**

Manufacturer	Product*	$\eta$ [%]	$U_{oc}$ [V]	$I_{sc}$ [A]	$P_{max}$ [W]	FF	Area [mm x mm]	$P_{max}/area$ [W/m <sup>2</sup> ]	Material
Creaton AG	Creaton Solesia		13.86	8.46	90 /module	0.77	1778 x 355	142.6	Mono-crystalline silicon cells
Rheinzink	PV Quickstep		17.10	5.12	68 /module	0.78	2000 x 365	93.2	Crystalline silicon cells
Abakus Solar AG	Peak On P220-60	13.2	36.77	8.22			1667 x 1000		Poly-crystalline silicon cells
	Peak On P235-60	14.6	37.21	8.48			1630 x 1000		
	ANT P6-60-230	14.07	36.77	8.42			1658 x 986		
DuPont	Gevity	17.7	24.20	8.77			1452.9 x 929		Mono-crystalline silicon cells
			-	-					
Suntech	MSZ-190J-D		45.2	5.62	190 /module	0.75	1641 x 834.5	139	Mono-crystalline silicon cells
	MSZ-90J-CH		22.4	5.29	90 /module	0.76	879 x 843.5	125	
Schott Solar	InDax 214	12.5	36.3	8.04			1769 x 999		Poly-crystalline silicon cells
	InDax 225	13.1	33.5	6.60					
Solar Century	C21e Slate	20 /cell	12.0	5.55	52	0.78	1174 x 318	139.3	Mono-crystalline silicon cells

\*Several models are available from various producers.

Creaton AG, Rheinzink and Suntech obtain approximately the same fill factor for their products. Abakus Solar, DuPont and Schott Solar do not provide a value for the maximum power, but are three of the few producers that provide a value for the module efficiency. The efficiency for Abakus Solar is between 12.7% and 14.6%, DuPont provides an efficiency of 17.7%, while Schott Solar's models are given with 12.5-13.1%. Solar Century reports an efficiency of 20% per cell for their C21e Slate. The distinction comes from the different materials, polycrystalline versus monocrystalline. Rheinzink have approved their product according to EN 61215, while both EN 61215 and EN 61730 have been applied for Abakus Solar's products, Dupont's Gevity, Suntech's products and Schott Solar's InDax (European Committee for Electrotechnical Standardization 2005, 2007a, 2007b). For further details see Appendix C.

### 3.3.4 Solar cell glazing products

Solar cell glazing products provide a great variety of options for windows, glassed or tiled facades and roofs. Different colours and transparencies can make many different aesthetically pleasing results possible. The modules transmit daylight and serve as water and sun protection. "The technology involves spraying a coating of silicon nanoparticles on to the glass or tile, which work as solar cells." (Jelle et al. 2012a). The distance between the cells depends on wanted transparency level and the criteria for electricity production, but normally the distance is between 3 and 50 mm. The space in between cells transmits diffuse daylight. This way, both shading and natural lighting are provided

while producing electricity. The producers of solar cell glazing products usually offer customized products for the specific project, but table 5 presents some predefined modules.

**Table 5: Literature data for some solar cell glazing products (references and further details given in Appendix D).**

Manufacturer	Product*	$\eta$ [%]	$U_{oc}$ [V]	$I_{sc}$ [A]	$P_{max}$ [W]	FF	Area [mm x mm]	$P_{max}/area$ [W/m <sup>2</sup> ]	Material
Abakus Solar AG	Peak In P210-60		36.50	7.70			2000 x 1066		Poly-crystalline silicon cells
Vidursolar	FV VS16 C36 P120		21.6	7.63			1600 x 720		Poly-crystalline silicon cells
Glaswerke Arnold GmbH & Co KG	Voltarlux-ASI-T-Mono 4-fach		93	1.97	100 /module	0.55	2358 x 1027	41.3	Amorphous silicon cells from Schott Solar
Schott Solar	ASI THRU-1-L	6	111	0.55	48	0.79	1122 x 690	62.0	Amorphous silicon cells
	ASI THRU-4-IO	6	111	2.22	190	0.77	1122 x 2619	64.7	
Sapa Building System	Amorphous silicon thin film	5 /cell			32 /cell		576 x 976 /cell	50	Amorphous silicon thin film
	Poly-crystalline	16 /cell			1.46-3.85 /cell		156 x 156 /cell	120	Poly-crystalline
	Mono-crystalline high efficient	22 /cell			2.90-3.11 /cell		125 x 125 /cell	155	Mono-crystalline high efficient

\*Several models are available from various producers.

The producers also offer customized modules regarding shape, cell material, colour and transparency level, i.e. distance between cells. Values for the efficiencies are not given for these products, but for Voltarlux a FF value of 0.55 is given with a transparency level of 10%. The transparency level varies from 16% to 41%, respectively smallest to largest size, for the Vidursolar models and is 25% for Abakus' Peak In P210-60. Other products and further details, including description of customized solutions, can be found in Appendix D.

### 3.3.5 Building attached photovoltaic products

The BAPV products are, as mentioned earlier, added on rather than integrated in the roof or facade. These products are not focused on in this study, but it is still interesting to have a look at some of them. In addition, Uni-Solar is used by several other manufacturers as given in section 3.3.1 and 3.3.2. Table 6 gives the properties for some of the BAPV products.

**Table 6: Literature data for some of the building attached photovoltaic (BAPV) products (references and further details given in Appendix E).**

Manufacturer	Product*	$\eta$ [%]	$U_{oc}$ [V]	$I_{sc}$ [A]	$P_{max}$ [W]	FF	Area [mm x mm]	$P_{max}/area$ [W/m <sup>2</sup> ]	Material
Uni-Solar	PVL-68		23.1	5.1	68 /module	0.58	2849 x 394	60.6	Amorphous silicon cells
	PVL-144		46.2	5.3	144 /module	0.59	5486 x 394	66.6	
Hauptsitz	SunPower 220 Solar Panel	17.7	48.6	5.75			1559 x 798		Mono- crystalline silicon cells
Isofoton	ISF-240	14.5	37.1	8.45	240	0.77	1667 x 994	144.8	

\*Several models are available from various producers.

The laminate from Uni-Solar is flexible, thus making it easy to incorporate it with other building materials. It is tested according to UL 1703, EN 61646 and EN 61730 (European Comitee for Electrotechnical Standarization 2007a, 2007b, 2008, Underwriters Laboratories Inc. 2002). The efficiency for Hauptsitz' product is 17.7% and Isofoton states an efficiency of 14.5% for their product. Further details and a small selection of various BAPV products are given in Appendix E.

### 3.3.6 Comparison

The tile products are more likely to be used on tiled roofs, i.e. residential houses. Due to the easy retrofitting with these products, this market is large; e.g. for roofs on residential buildings there is a 6800 km<sup>2</sup> BIPV area potential, fulfilling good solar yield criteria (80% of the maximum local annual solar input), in the United States alone (Nowak et al. 2000, Prasad and Snow 2005). The other products can be used on most structures either together with traditional roofing material or covering the entire roof. The PV foil has a very wide range of usage due to the flexibility, but the efficiency is low, thus the applied area must be relatively large in order to achieve an output comparable with the other products. The modules and the solar cell glazing products can be used on both roofs and facades achieving aesthetically pleasing results. This also facilitates using the areas with the highest levels of solar irradiance on geographically challenging locations. However it is not justified to make a comparison between these products, due to different areas of application as well as different demand for effect, costs and available area. In order to simplify the information exchange, the BIPV manufacturers may improve their specifications and availability regarding the mounting of their products.

## 3.4 Economics

The global market for BIPVs is expected to grow from \$1.8\*10<sup>9</sup> in 2009, to \$8.7\*10<sup>9</sup> in 2016, according to consulting firm NanoMarkets, New York (Coons 2009). In addition, NanoMarkets say that CIGS will account for 17% of the BIPV market by volume in 2016 and polysilicon-based BIPVs volume will drop from 75% of the market to 33% by 2016 (Coons 2009). A long term cost trend for PV module costs is shown in figure 5, and the historical growth of the worldwide PV market is shown in figure 6 (Breyer et al. 2010, Wawer et al. 2011).

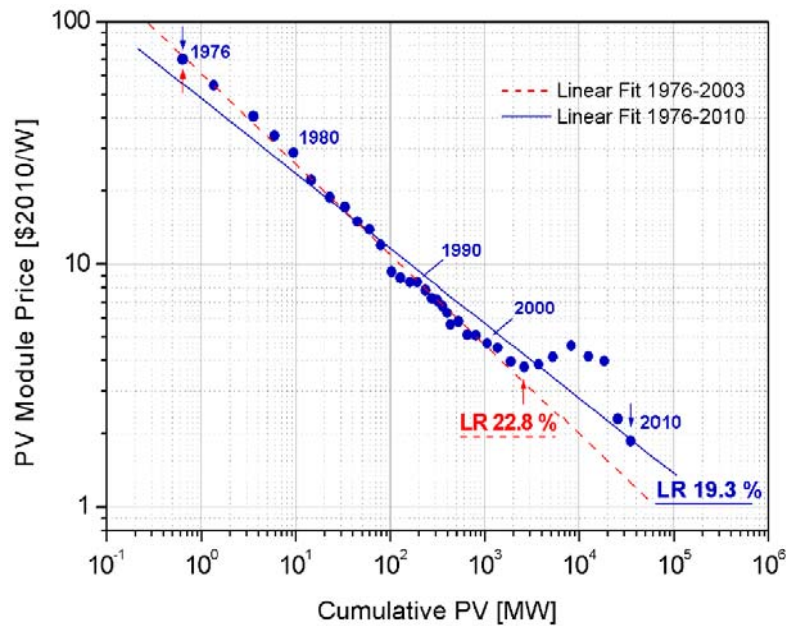

Figure 5: “Learning curve for PV modules for the mid 1970s – 2010. Long term cost trend of reducing PV module cost by 20% per doubling of historic cumulative average production and installations has been stable for the entire period” (Breyer et al. 2010).

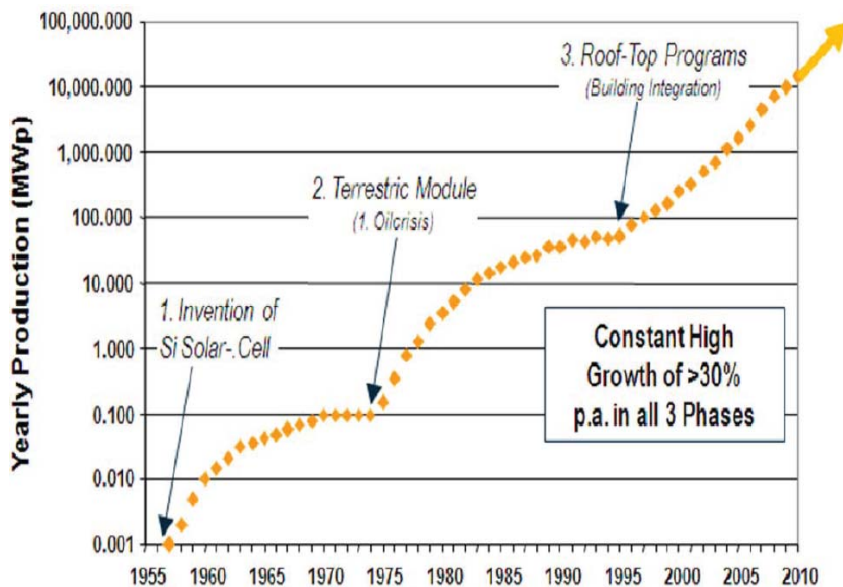

Figure 6: Historical growth of worldwide PV market (Wawer et al. 2011).

The growth of the photovoltaic industry has been investigated by a patent growth analysis carried out by Liu et al. (2011). “Life cycle cost (LCC) is the time-adjusted sum of all time-adjusted costs of a given system over the specified period, and must be compared with the LCC alternative system in order to make an informed choice between them. Basically BIPV system requires a big capital construction cost but no operating fuel cost.” (Eiffert and Kiss 2000).

As PV panels occupy a large area for installation, the associated financial challenge could be best answered by space-saving technologies like BIPVs (Paul et al. 2010). Incorporation of PV materials into products such as roofing materials, windows, awnings and glassed facades provides the opportunity for cost reduction by replacing common building materials with PV materials at marginal

costs (Norton et al. 2011). When compared to glass, steel or other more conventional cladding materials, installing BIPVs adds only a marginal extra cost (2% - 5%) to the overall construction costs of a commercial building (Eiffert 2003). BIPV technology is still rather expensive. One of the reasons for this is that the PV technology is still a growing technology, so BIPV manufacturers are at the beginning of their technological development (IEA-PVPS 2000). In Europe today a maximum payback time for PV modules of ten years is generally expected, which is not possible to achieve without subsidies. The countries developed for grid connected PV systems give a higher price into the grid than exerting from the grid. In many countries there are no systems for buying the electricity produced by PV systems even though the technical solutions for redistribution of the electricity exist. If a system like the one mentioned above is established, the PV industry may have a brighter future. However, a better solution would be to distribute the electricity locally and then buy from / sell to the grid whenever needed, even though this might result in a more difficult technical solution for the electricity companies. For a building owner, the installation and operation cost of the BIPV system might be offset by selling the surplus electricity to a utility company (IEA-PVPS 1999). Over time, the cost of a PV system will decline with the improvement of technical advances, thus a lower price per kW installed will be obtained (Sozer and Elnimeiri 2007). This is an important part of the development to make installation and building integration of PV products profitable without subsidies.

### 3.5 Energy payback time for photovoltaic systems

When considering different renewable energy systems, the energy payback time is essential. It describes the amount of time it takes the solar module to create as much energy as was used to create itself. In order to determine the energy payback time the embodied energy of the system must be estimated (Hammond et al. 2012). The embodied energy in the materials required to manufacture a 2.1 kWp BIPV system is displayed in figure 7 (Hammond et al. 2012).

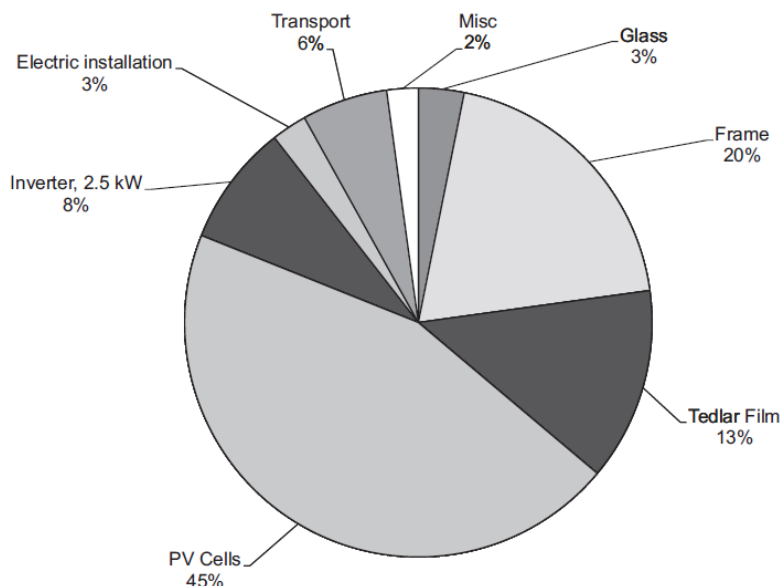
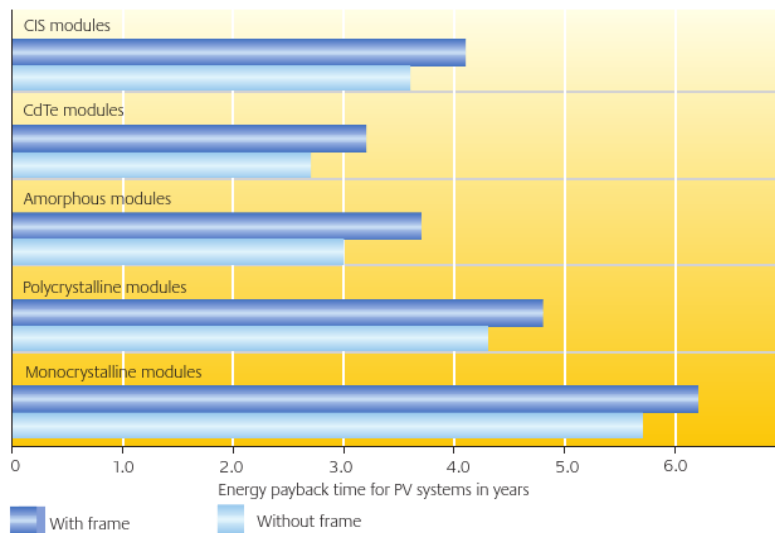

Figure 7: Embodied energy of a 2.1 kWp BIPV grid-tied system (Hammond et al. 2012).

A study carried out in Switzerland on life cycle analysis (LCA) of twelve small PV power plants, each with the capacity of 3 kWp, gave an energy payback time of 4 to 6 years for monocrystalline cells and 3.5 to 4.5 years for polycrystalline cells (Dones et al. 2007). The values are influenced by the choice of

reference system and indicators. These numbers are more or less supported by energy payback times in Germany; 5.6-6.1 years for monocrystalline PV systems and approximately 4.5 years for polycrystalline PV systems as shown in figure 8 (The German Energy Society (DGS) 2008).



**Figure 8: “Energy payback time for PV systems in Germany based on the average values from various studies” (Alsema 2000, Jungbluth and Frischnecht 2000, Knapp and Jester 2000, Pehnt et al. 2003). From The German Energy Society (DGS) (2008).**

The study conducted on PV modules installed in Switzerland estimates 2.5-3.5 years energy payback time for future monocrystalline based modules and 2-3 years for future polycrystalline modules, while the study for Europe in general predicts below one year of energy payback time for both mono- and polycrystalline based modules (Alsema et al. 2006, Dones et al. 2007). Both studies assume higher efficiencies of the PV cells, hence shorter payback time.

Another LCA study presented at the 21st European Photovoltaic Solar Energy Conference in Germany in 2006 resulted in an energy payback time of 2 years in Southern Europe and 3-3.5 years in Middle-Europe with little variation between mono- and polycrystalline cells. The irradiation considered is 1700 kWh/(m<sup>2</sup>year) for Southern Europe and 1000 kWh/(m<sup>2</sup>year) for Middle-Europe. The energy payback time results for amorphous silicon are 1-1.5 years in Southern Europe (Alsema et al. 2006).

When it comes to service life, avoiding too high temperatures is essential. “Heat is the key of the BIPV design. If the temperature of photovoltaic modules is too high, it will affect the efficiency of solar cells, the structure performance of the components and service life” (Wei et al. 2011). Sunpower offers a 10 year complete system warranty, and a 25-year limited warranty on solar electricity output for their SunTile BIPV product (see Appendix B). Solon on the other hand gives an output guarantee of 90% for 10 years, and an 80% output guarantee for 25 years for their BIPV product Solon Black (see Appendix C). This applies for many of the manufacturers listed in the appendices. The energy analysis of a case study conducted in the United Kingdom revealed that a 2.1 kWp installed BIPV system, despite requiring large amounts of embodied energy to manufacture, had a short energy payback period of just 4.5 years, in contrast to an expected 25 year system lifetime (Hammond et al. 2012).



## 4 Future research opportunities

### 4.1 New materials and solutions for BIPVs

The future research opportunities are based on the existing products. Many of the products can achieve a higher efficiency with better materials and better solutions. Naturally, advances in the development of PV materials will lead to advances for the BIPV systems. The challenge is achieving this at a viable cost.

#### 4.1.1 New materials and technologies

New PV technologies that may initiate and advance new innovations, which may be developed into building integrated photovoltaics, might be found in various fields, e.g. (a) ultra-low cost, low-medium efficiency organic based modules, (b) ultra-high efficiency modules, (c) solar concentrator and/or solar trapping systems embedded in solar cell surface and material beneath, and (d) flexible lightweight inorganic thin film solar cells, or others.

The ultra-low cost, low-medium efficiency organic based modules are based on dye sensitized solar cells (DSSC), extremely thin absorbers, organic polymer cells, etc. Organic semiconductors are less expensive than inorganic semiconductors like Si. The superior material properties of polymers combined with cheap processing techniques has made polymer based materials present in almost every part of the modern society (Spanggaard and Krebs 2004). The highest reported efficiency for an organic solar cell (with the exception of DSSC) is 6.5%, and this makes them competitive with CO<sub>2</sub>-producing technologies (Mayer et al. 2007). The polymer solar cells are however more sensitive when it comes to degradation. Oxygen from the atmosphere will oxidize the organic layer. More stable devices have already been made and progress in this field is important for polymer solar cells to have a future as commercial devices and to be used in various BIPVs (Jørgensen et al. 2008).

The ultra-high efficiency modules are based on quantum cells and nano-structured devices, e.g. the record efficiencies for polymer-based solar cells have been observed in disordered nano-structured heterojunctions, and further gains are expected upon optimizing ordered nano-structure architectures (Mayer et al. 2007). Solar concentrator systems are described with arrays of PV modules that are mounted onto large movable structures which are continuously aimed at the sun.

A great deal of this new technology is already well known. However, it takes time for the products to establish themselves in the market. The dye sensitized solar cell (DSSC) is an example of this. DSSCs usually have a titanium dioxide (TiO<sub>2</sub>) substrate material like in the Grätzel solar cell. The technology imitates the photosynthesis and is by Grätzel called “the artificial leaf”, see figure 9 (Grätzel 1991). The cells absorb across the visible spectrum and therefore lead to increased efficiency ranging from 7% under direct solar irradiation (AM1.5) and up to 11% in diffuse daylight (Grätzel 2003, Kim et al. 2012, Li et al. 2012, Prasad and Snow 2005). The TiO<sub>2</sub> material is a renewable and non-toxic white mineral, and will therefore give smaller environmental impacts. An easy manufacturing process contributes to lower costs.

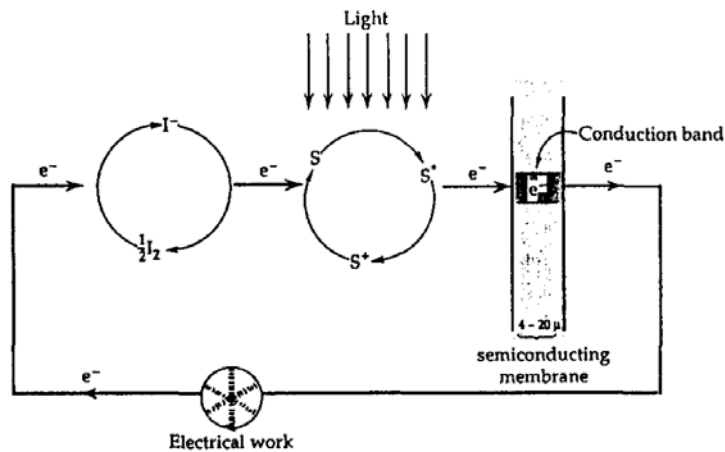

Figure 9: The principles of the artificial leaf: the chlorophyll in plants is replaced by a transition metal sensitizer while the phospholipid membrane is exchanged for a ceramic semiconducting membrane made of  $\text{TiO}_2$ . As in photosynthesis, the new solar converter constitutes a molecular electron pump driven by sunlight (Grätzel 1991).

Coloured dyes for use in DSSC based on the  $\text{TiO}_2$  cell are developed by Massey University's Nanomaterials Research Centre and they predict costs of one 10th of the silicon based cells (ScienceDaily 2007). The reduced production costs and the decreased environmental impacts result in shorter energy and economical payback time, and therefore makes the technology very promising. The market share for this technology is still very small, but it is expected to rise and may achieve a great influence in the future.

An option for more effective harvesting of solar energy is so-called "antennas" (figure 10), which can harvest several wavelengths, i.e. a much broader spectrum of the solar radiation. This may be compared to more "traditional" sandwich solar cells. "The use of antenna-sensitizer molecular devices may constitute a viable strategy to overcome problems of light harvesting efficiency in the spectral sensitization of wide-bandgap semiconductors." (Amadelli et al. 1990).

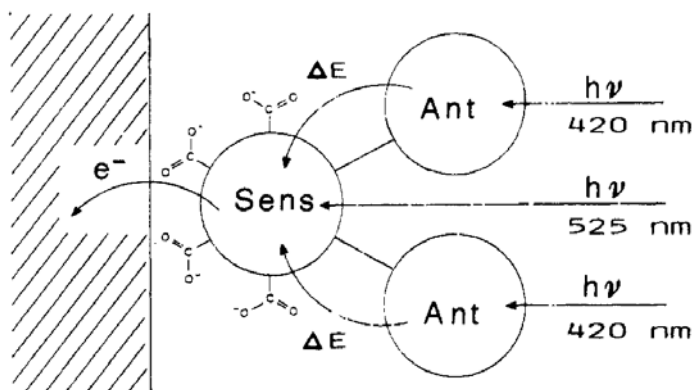
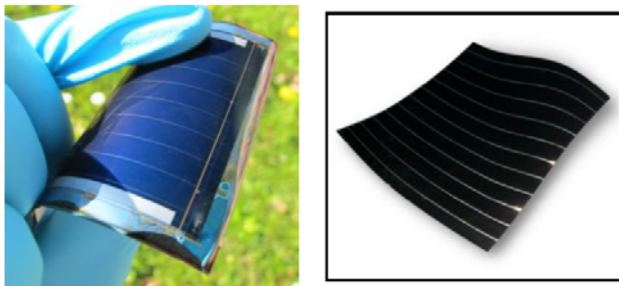

Figure 10: Block diagram showing the function of the trinuclear complex as an antenna-sensitizer molecular device (Amadelli et al. 1990).

Research laboratories have for many years produced high-performance cells with efficiencies up to 25%-40% (The German Energy Society (DGS) 2008, Wesoff 2011). One approach is to use material with higher purity and to eliminate the impurities along in the process. Also the back surface can be passivated with silicon oxide and amorphous silicon to minimize recombination losses at the surfaces and contacts. Textured surfaces and buried contacts with minimal shading reduce optical losses. The total production is very expensive and is to date for use in laboratories only. Another way of

increasing the efficiency can be concentrated photovoltaic (CPV) cells. Efficiencies reaching 43.5% has been achieved for commercial-ready CPV cells (Wesoff 2011). These cells are typically applied in the concentrator modules based on a concept of the small-aperture refractive concentrators (Andreev et al. 2004).

Figure 11 shows photographs of flexible CIGS and CdTe solar modules. The flexible and lightweight CIGS and CdTe solar devices has in an experiment by Buecheler et al. (2011) yielded an active area efficiency of 14.7% (CIGS) and 9.4% (CdTe). These devices allow building integration in structures which cannot take the additional load of heavy and rigid glass laminated solar modules. "The flexible solar modules can be laminated to building elements such as flat roof membranes, tiles or metallic covers without adding weight and thus, the installation costs can be reduced significantly." (Buecheler et al. 2011).



**Figure 11: Flexible and lightweight CIGS (left) and CdTe (right) solar modules (Buecheler et al. 2011).**

The solar cell glazing products available today have potential for optimization, e.g. the solar radiation utilized in a solar cell cannot be exploited as daylight in the buildings. "One might also envision incorporating solar cells or photovoltaics with electrochromic materials in completely new fenestration products, where the photovoltaic and electrochromic material or materials cover the whole glazing area." (Jelle et al. 2012a).

More of the new material technology includes crystalline silicon on glass (CSG), copper indium gallium diselenide (CIGS), microamorphous silicon cells, concentrating systems and hybrid solar cells (HIT). Dow Chemical has introduced a line of CIGS-based solar shingles that will be commercially available in late 2011. This BIPV solar shingle installs and performs like a standard asphalt shingle, has an expected lifespan of 15-20 years (on par with conventional asphalt shingles), and has received a GLOBE Foundation award for "Environmental Excellence in Emerging Technology" (Coons 2009 and Dow Chemical 2010). This is expected to be a huge contribution in bringing affordable renewable energy to consumers. The development of new PV materials and technologies will in the future contribute to new and improved BIPV products, e.g. with higher solar efficiencies.

#### **4.1.2 New solutions**

The new solutions in the PV industry are many and various. There is usually room for improvement in each specific system, e.g. regarding ventilation rate, positioning, removing of snow etc. For good integration results, the BIPV system has to be included early in the planning process. Communication between the planners and manufacturers of BIPV products is important for the development of new BIPV solutions. If the PV cells used are mono- or polycrystalline, it is very important to achieve a sufficient ventilation rate, as the solar cell efficiency normally decreases with increasing temperature, and should therefore be planned ahead of the construction phase. If the temperatures reach high

levels one might have to install compensating solutions, such as fans etc., although usually not optimal regarding maintenance and energy efficiency.

It is expected that the systems will improve in the near future both regarding efficiency of the product and the production phase leading to decreased energy payback time. This is, however, dependent on the market situation and/or subsidies.

One might envision miscellaneous PV surface solutions for increasing solar cell efficiency and/or profitability. For example, various solar radiation trapping mechanisms might be embedded in the surface. Furthermore, one may be able to make an exterior surface capable of harvesting as much solar energy as if the whole exterior surface was covered with a PV material, while in fact the actual PV material surface is considerably smaller and located somewhat beneath the exterior surface, hence reducing the PV material costs. In principle, the latter one might be viewed as a special built-in concentrator system integrated within the PV surface, thus requiring less (expensive) solar cell material.

A macroscopic or full scale solar cell concentrator is shown in figure 12 (Tao et al 2011). Tao et al (2011) found that a new type of trough solar concentrator "...can actualize reflection focusing for the sun light using multiple curved surface compound method. It also has the advantages of improving the work performance and environment of high-temperature solar absorber and enhancing the configuration intensity of the reflection surface". With referral to the discussion in the preceding paragraph, the idea might then be to fabricate a "solar concentrator" at a microscopic level embedded in the PV surface and beneath.

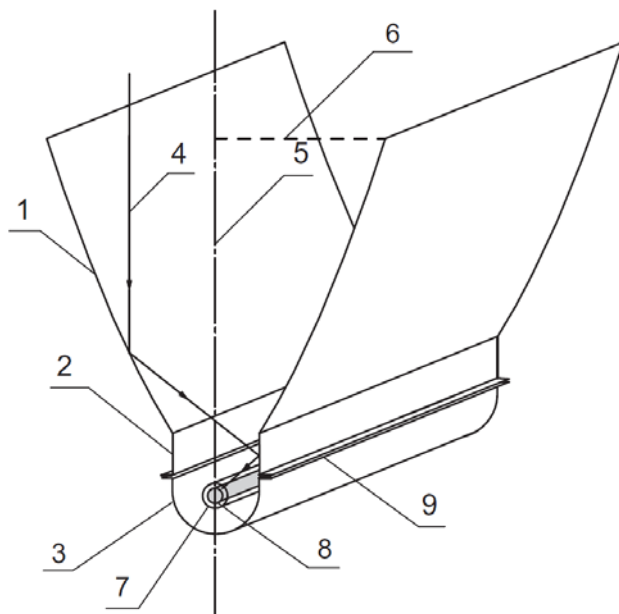

**Figure 12: Schematic diagram of the new trough solar concentrator. (1) the new compound parabolic concentrator; (2) secondary reflection plane mirror; (3) lower trough parabolic concentrator; (4) parallel light; (5) symmetry axis; (6) half aperture of import light; (7) transparent vacuum glass tube; (8) high-temperature solar receiver (Tao et al. 2011). One may envision to manufacture a "solar concentrator" at a microscopic level embedded in the PV surface and beneath.**

Inspiration for new solutions for BIPV systems can be gathered from this type of application. The BIPV might be formed as a trough at a material level, and hence lead to improved efficiency and reduced costs of the building integrated PV cells.

Another option for more effective solar energy harvesting is the inverted pyramid texturing of the solar cell (figure 13) (Smith and Rohatgi 1993). The great light trapping properties of the inverted pyramid geometry is due to the following three effects: (1) reduced front surface reflectance by providing the opportunity for a portion of the incoming solar rays to undergo a triple bounce, (2) increase in path length of the solar ray through the cell, thus absorbing a larger fraction of the solar rays which has entered the cell before exiting the cell, and (3) increase in amount of solar rays reflected from the back surface, by total internal reflection at the front surface/air interface by making the incident angle greater than the critical angle. The inverted pyramid texture on solar cells is estimated to give cell efficiencies of approximately 24% with realistic cell design and material parameters (Smith and Rohatgi 1993).

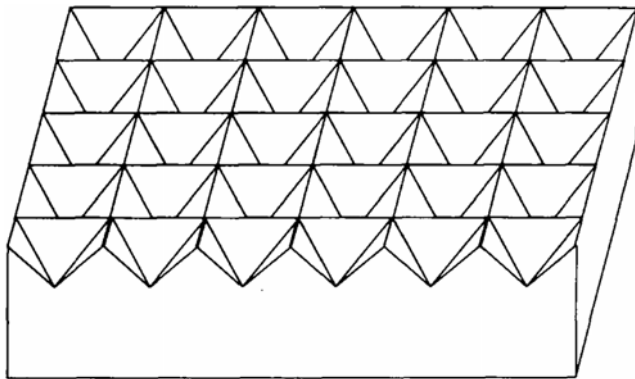

Figure 13: The inverted pyramids geometry used for light trapping on silicon solar cells (Smith and Rohatgi 1993).

#### 4.1.3 Further integration of photovoltaic cells

A future option that e.g. Enecolo and SolarPower Restoration Systems Inc. has looked into is integrating the PV cells in materials at an early stadium e.g. in prefabricated concrete plates (Prasad and Snow 2005, SolarPower 2011). Concrete is the most widely used construction material in the world, and the integration of PV with concrete surfaces has remained largely undeveloped, thus presenting a research field with very high potential.

Another future option can be thin laminate or paint layer solar cell materials. Javier and Foos (2009) fabricated a complete photovoltaic cell using a handheld airbrush, dilute solutions of CdSe and CdTe nanorods, commercially available silver paint, and transparent-conducting-electrode-coated glass. They explored the suitability of a handheld airbrush to create high-quality films and were able to form ultra smooth surfaces from 20 to 500 nm thickness. Current estimated efficiency is very low, but the research demonstrates the variety in the potential of PV cells (Javier and Foos 2009).

Another option, which is already being explored, is integrating PV with smart windows in a way that the PV elements will provide shading when there is need for it (Deb et al. 2001). This way, electricity will be produced while the window blocks the solar radiation. In the building industry electrochromic windows with no external wiring are most desirable. The National Renewable Energy Laboratory of Golden, USA have built self-powered photovoltaic electrochromic devices up to 25 cm<sup>2</sup> (Baetens et al. 2010). For these self-powered PV electrochromic devices, "...the main concerns for future large-area applications are the possible loss of the energy generated by the PV device for larger dimensions, a small range of optical modulation and rather low transmittances in the clear state." (Baetens et al. 2010).

## 4.2 Long-term durability of new materials and solutions

It is important that the new building materials, integrated technology and solutions are planned simultaneously with the building envelope. This includes requirements for rain, wind and air tightness, building physical considerations and long-term durability regarding climate exposure. Building physical considerations include investigation of the moisture transport and with this the condensation risk. With new materials the moisture transport and distribution within the building element might change, and knowledge about these aspects are important.

The long-term durability versus the various climate exposure factors need to be considered. Examples of this are (Jelle et al. 2012b):

- Solar radiation (UV-VIS-NIR)
- Ambient infrared (IR) heat radiation
- High and low temperatures
- Temperature changes/cycles giving freezing/thawing processes
- Water, e.g. moisture and wind-driven rain
- Physical strains, e.g. snow loads
- Wind
- Erosion, also from above factors
- Pollutions, e.g. gases and particles in air
- Microorganisms
- Oxygen
- Time for all the factors above to work

All new products should achieve approval in accordance with the current standards. For thin-film PV cells the test procedures are given in standard EN 61646, and for crystalline silicon PV cells EN 61215 applies. Many of the tests given are to determine the durability of the product in the different conditions, and all climate exposure factors above except for pollution, microorganisms and oxygen are included. Test procedures for these factors may be found in the standard UL 1703. Some of the new technology will not be considered by these standards. As far as it is possible the existing standards can be used. With further development of new materials, there is a need for new standards specifying procedures for these materials.

The standards describe test procedures for the robustness of terminations test. However, since the standards are based on the PV module only, further testing procedures of the module integrated in the building should be developed with the increasing interest and production of BIPVs.

## 4.3 Visions for the future

The main target is BIPVs replacing conventional roof and facade materials. This is already in progress as the global market for BIPVs in 2009 was  $\$1.8 \cdot 10^9$ , and it is expected to grow to  $\$8.7 \cdot 10^9$  in 2016 (Coons 2009). Nevertheless, there is still a great need of increasing the volume of PV and BIPV produced electricity.

Many new pathways exist beyond the current BIPVs. Some of the possible paths have already been mentioned in the previous chapters. New developed technologies may give a huge variety of

solutions. Low production costs, low environmental impacts and high efficiencies are key factors for the future development.

The research and development of solutions regarding BIPVs for the retrofitting market are of great importance as the volume of existing buildings is many times greater than the volume of buildings to be constructed. The market for retrofitting of roofs is already under development and is growing, e.g. in Hong Kong, where similar BIPV concepts can be applied to facade systems (Lo 2006). Easy application of PV cells in existing materials is essential, and it may in the future be performed by e.g. various paint techniques.

Future solar cell materials may be envisioned with the possibility of internal energy storage, e.g. analogous to a photoelectrochemical solar cell (PEC) with internal storage. There are various battery-technologies out there, e.g. metal hydrides. Nano technologies could be one of many possible ways of increasing energy storage density.

In various countries there is a great need for governmental subsidies to get the industry started as it has been carried out with success in southern Europe. Along with this, a system for feeding the grid with PV electricity is necessary.

Solar cell glazing products enable an almost unlimited range of opportunities. BIPVs as solar cell glazing products, providing both solar shading, daylight transmission and producing electricity, are very valuable and may be even more utilized in the future. Furthermore, forthcoming theoretical and experimental explorations may provide the PV and BIPV industry with several new and innovative materials and solutions. "Future solar cell materials may also be envisioned as thin laminate or paint layers, hence also enabling application by paint brush or spray." (Jelle et al. 2012a). A development towards higher efficiency and better thermal insulation properties increases the energy efficiency and shortens payback time, e.g. highly relevant in the northern part of Europe.

## 5 Conclusions

The present study has shown that there are great variations in the available building integrated photovoltaic (BIPV) products. This study has encountered only one photovoltaic foil BIPV product commercially available. In general, foil products may have a great range of application due to the flexibility of the material. The categories tiles and modules include numerous products and some of them are not very distinctive when it comes to how they are mounted, thus making it somewhat difficult to categorize them. However, there are many interesting products that both seem to give good weather tightness, satisfactory appearance and fairly high efficiencies. In most of the products, many opportunities exist regarding what type of roof material to be combined with the PV material. The solar cell glazing products included in this study are mainly predefined modules. These may give a great aesthetical appearance in addition to provide weather tightness, solar shading and natural lighting. However, the total area efficiencies are quite low. This is, among other factors, due to the glass spacing between the PV cells.

New technologies under development will in the future provide BIPVs with higher efficiencies and lower production costs. This will lead to shorter energy and economical payback times. Some of the new concepts are organic based PVs, such as dye sensitized TiO<sub>2</sub> cells, and high efficiency modules. New solutions can also both reduce costs and increase the market share, amongst other in the

retrofitting market. The solutions should be easily applicable, and an example of future visions is paint applications of PV cells. All new technologies and solutions should be thoroughly tested and approved in accordance with existing standards. Furthermore, with new products there is a need for development of new standards and methods, e.g. regarding long-term durability versus climate exposure.

## Acknowledgements

This work has been supported by the Research Council of Norway and several partners through the NTNU and SINTEF research project "The Research Centre on Zero Emission Buildings" (ZEB).

## References

Note that all references related to the tables in the appendices are given as a web page address in the relevant table, and are thus not included in this reference list.

E. A. Alsema, "Energy payback time and CO<sub>2</sub>-emissions of PV systems", *Progress in Photovoltaics: Research and Applications*, **8**, 17-25, 2000.

E. A. Alsema, M.J. de Wild-Scholten and V.M. Fthenakis, "Environmental Impacts of PV Electricity Generation - A Critical Comparison of Energy Supply Options", Copernicus Institute, Energy research Centre of the Netherlands ECN, National Photovoltaic EH&S Research Center, 2006.

R. Amadelli, R. Argazzi, C. A. Bignozzi and F. Scandola, "Design of antenna-sensitizer polynuclear complexes", *Journal of the American Chemical Society*, **112**, 7099-7103, 1990.

I. Andresen, "Building Integrated Photovoltaics in Smart Energy-Efficient Buildings. A State of the Art", *STF22 A04505*, SINTEF Civil and Environmental Engineering, 2004.

V. M. Andreev, V. A. Grilikhes, V. P. Khvostikov, O. A. Khvostikova, V. D. Romyantsev, N. A. Sadchikov and M. Z. Shvarts, "Concentrator PV modules and solar cells for TPV systems", *Solar Energy Materials and Solar Cells*, **84**, 3-17, 2004.

R. Baetens, B. P. Jelle and A. Gustavsen, "Properties, requirements and possibilities of smart windows for dynamic daylight and solar energy control in buildings: A state-of-the-art review", *Solar Energy Materials and Solar Cells*, **94**, 87-105, 2010.

C. Breyer, C. Birkner, F. Kersten, A. Gerlach, G. Stryi-Hipp, J. C. Goldschmidt, D. Montoro and M. Riede, "Research and development investments in PV – A limiting factor for a fast PV diffusion?", *25<sup>th</sup> EU PVSEC/WCPEC-5*, Valencia, September 6-10, 2010.

S. Buecheler, A. Chirilă, J. Perrenoud, L. Kranz, C. Gretener, P. Blösch, F. Pianezzi, S. Seyrling and A. N. Tiwari, "Flexible and lightweight solar modules for new concepts in building integrated photovoltaics", *Proceedings CISBAT*, Lausanne, Switzerland, September 14-16, 2011.

R. Coons, "Dow: Solar shingles could generate \$5 Billion by 2015", *Chemical Week*, **171** (25), 9, 2009.

S. K. Deb, S.-H. Lee, C. Edwin Tracy, J. Roland Pitts, B. A. Gregg and H. M. Branz, "Stand-alone photovoltaic-powered electrochromic smart window", *Electrochimica Acta*, **46**, 2125-2130, 2001.



R. Dones, C. Bauer, R. Bollinger, B. Burger, T. Heck and A. Röder, "Life Cycle Inventories of Energy Systems: Results for Current Systems in Switzerland and other UCTE Countries", Ecoinvent Centre, 2007.

Dow Chemical Company, "DOW™ POWERHOUSE™ Solar Shingle wins GLOBE award for environmental excellence in emerging technology", M. McCaffrey and G. Nolan (Eds.), Vancouver, Canada, March 24, 2010, <http://www.dowsolar.com/news/2010/20102403.htm> (accessed December 5, 2011).

A. Ebong, I. B. Cooper, B. Rounsaville, K. Tate, A. Rohatgi, B. Bunkenburg, J. Cathey, S. Kim and D. Ruf, "High efficiency inline diffused emitter (ILDE) solar cells on mono-crystalline CZ silicon", *Progress in Photovoltaics: Research and Applications*, **18**, 590-595, 2010.

P. Eiffert and G. Kiss, "Building integrated photovoltaic design for commercial and institutional structures", NREL/BK-520-25272, 2000.

P. Eiffert, "Guidelines for the economic evaluation of building integrated photovoltaic power systems", NREL/TP-550-31977, 2003.

Eotec Energy AG Inc., "Standard Test Conditions", (not dated) [http://ecotec-energy.com/gekuehlte\\_photovoltaik/bedingungen\\_e.htm](http://ecotec-energy.com/gekuehlte_photovoltaik/bedingungen_e.htm) (accessed November 11, 2011).

European Comitee for Electrotechnical Standarization, "Crystalline silicon terrestrial photovoltaic (PV) modules - Design qualification and type approval", EN 61215, European Standard, 2005.

European Committee for Electrotechnical Standarization, "Photovoltaic (PV) module safety qualification - Part 1: Requirements for construction", EN 61730-1, European Standard, 2007a.

European Committee for Electrotechnical Standarization, "Photovoltaic (PV) module safety qualification - Part 2: Requirements for testing", EN 61730-2, European Standard, 2007b.

European Comitee for Electrotechnical Standarization, "Thin-film terrestrial photovoltaic (PV) modules - Design qualification and type approval", EN 61646, European Standard, 2008.

Global Energy Network Institute, "Suntech to develop 20 % of BIPV Solar Rooftop Program projects", November 13, 2009, <http://www.geni.org/globalenergy/library/technical-articles/generation/solar/pv-tech.org/suntech-to-develop-20%25-of-bivp-solar-rooftop-program-projects,-china/index.shtml> (accessed November 8, 2011).

M. Grätzel, "The artificial leaf, molecular photovoltaics achieve efficient generation of electricity from sunlight", *Coordination Chemistry Reviews*, **111**, 167-174, 1991.

M. Grätzel, "Dye-sensitized solar cells", *Journal of Photochemistry and Photobiology C: Photochemistry Reviews*, **4** (2), 145-153, 2003.

Green World Investor, "Efficiency of solar cells made of silicon (monocrystalline, multicrystalline), thin film (CIGS, CIS, aSi, CdTe, CZTS), multijunction", April 17, 2011, <http://www.greenworldinvestor.com/2011/04/17/efficiency-of-solar-cells-made-of-siliconmonocrystallinemulticrystalline-thin-film-cigscisasicdtecztsmultijunction/> (accessed December 11, 2011).

G. P. Hammond, H. A. Harajli, C. I. Jones and A. B. Winnett, "Whole systems appraisal of a UK building integrated photovoltaic (BIPV) system: Energy, environmental, and economic evaluations", *Energy Policy*, **40**, 219-230, 2012.

IEA-PVPS, "Grid connected power systems: Summary of IEA/PVPS Task V Activities from 1993 to 1998", T5-03, 1999.

IEA-PVPS, "Annual report 2000, statistics, installed PV power in IEA-PVPS countries", unpublished report, 2000.

S. Ishizuka, A. Yamada, K. Matsubara, P. Fons, K. Sakurai and S. Niki, "Development of high-efficiency flexible Cu(In,Ga)Se<sub>2</sub> solar cells: A study of alkali doping effects on CIS, CIGS, and CGS using alkali-silicate glass thin layers", *Current Applied Physics*, **10**, 154-156, 2010.

A. Javier and E. E. Foos, "Nanocrystal photovoltaic paint sprayed with a handheld airbrush", *IEEE Transactions on Nanotechnology*, **8** (5), 569-573, 2009.

B. P. Jelle, A. Hynd, A. Gustavsen, D. Arasteh, H. Goudey and R. Hart, "Fenestration of today and tomorrow: A state-of-the-art review and future research opportunities", *Solar Energy Materials & Solar Cells*, **96** (1), 1-28, 2012a.

B. P. Jelle, T.-N. Nilsen, P. J. Hovde and A. Gustavsen, "Accelerated climate aging of building materials and characterization by fourier transform infrared radiation analysis", In press, *Journal of Building Physics*, 2012b, DOI: 10.1177/1744259111423367.

N. Jungbluth and R. Frischnecht, "Literaturstudie ökobilanz photovoltaikstrom und update der ökobilanz für das Jahr 2000", Bericht im Auftrag des Bundesamtes für Energie, Projekt-Nr. 39489, 2000.

M. Jørgensen, K. Norrman and F. C. Krebs, "Stability/degradation of polymer solar cells", *Solar Energy Materials and Solar Cells*, **92**, 686-714, 2008.

G. S. Khrypunov, V. R. Kopach, A. V. Meriuts, R. V. Zaitsev, M. V. Kirichenko and N. V. Deyneko, "The influence of prolonged storage and forward-polarity voltage on the efficiency of CdS/CdTe-based film solar cells", *Semiconductors*, **45** (11), 1505-1511, 2011.

D. H. Kim, S. Lee, J. H. Park, J. H. Noh, I. J. Park, W. M. Seong and K. S. Hong, "Transmittance optimized nb-doped TiO<sub>2</sub>/Sn-doped In<sub>2</sub>O<sub>3</sub> multilayered photoelectrodes for dye-sensitized solar cells", *Solar Energy Materials and Solar Cells*, **96**, 276-280, 2012.

K. E. Knapp and T. L. Jester, "An empirical perspective on the energy payback time for photovoltaic modules", *Solar 2000 Conference*, Madison, WI, 2000.

Y. Li, L. Jia, C. Wu, S. Han, Y. Gong, B. Chi, J. Pu and L. Jian, "Mesoporous (N, S)-codoped TiO<sub>2</sub> nanoparticles as effective photoanode for dye-sensitized solar cells", *Journal of Alloys and Compounds*, **512** (1), 23-26, 2012.

J. S. Liu, C.-H. Kuan, S.-C. Cha, W.-L. Chuang, G. J. Gau and J.-Y. Jeng, "Photovoltaic technology development: A perspective from patent growth analysis", *Solar Energy Materials and Solar Cells*, **95**, 3130-3136, 2011.

E. W. C. Lo, "Recent projects of building integrated photovoltaic in Hong Kong", *2nd International Conference on Power Electronics Systems and Applications, ICPEA*, art. no. 4147783, pp. 62-67, 2006.

A. C. Mayer, S. R. Scully, B. E. Hardin, M. W. Rowell and M. D. McGehee, "Polymer-based solar cells", *Materials today*, **10**, 28-33, 2007.

McKinsey & Company, "Pathways to a Low-Carbon Economy. Version 2 of the global greenhouse gas abatement cost curve", McKinsey & Company, 2009.

T. Murphy, "Don't be a PV efficiency snob", *Energy Bulletin*, Post Carbon Institute, September 26, 2011, <http://www.energybulletin.net/stories/2011-09-26/don%E2%80%99t-be-pv-efficiency-snob> (accessed December 3, 2011).

J. Neuwald, "All you need to know about building integrated photovoltaics – Part 2", (not dated), Roofconsult, <http://www.roofconsult.co.uk/articles/kalzip2.htm> (accessed November 9, 2011).

B. Norton, P. C. Eames, T. K. Mallick, M. J. Huang, S. J. McCormack, J. D. Mondol and Y. G. Yohanis, "Enhancing the performance of building integrated photovoltaics", *Solar Energy*, **85**, 1629-1664, 2011.

S. Nowak, M. Gutschner, P. Toggweiler and D. Ruoss, "Potential for building integrated photovoltaics, solar-yield differentiated area potential for some selected IEA countries", NET Nowak Energy & Technology Ltd., Ursen, Switzerland; Enecolo Ltd., Mönchaltorf, Switzerland, 2000.

D. Paul, S. N. Mandal, D. Mukherjee and S. R. Bhadra Chaudhuri, "Optimization of significant insolation distribution parameters – A new approach towards BIPV system design", *Renewable Energy*, **35** (10), 2182-2191, 2010.

M. Pehnt, A. Bubenzer and A. Räuber, "Life cycle assessment of photovoltaic systems – Trying to fight deep-seated prejudices", *Photovoltaics guidebook for decision makers. Status and potential role in energy technological economy*, A. Bubenzer and J. Luther (Eds.), Springer-Verlag, pp. 179-213, 2003.

C. Peng, Y. Huang and Z. Wu, "Building-integrated photovoltaics (BIPV) in architectural design in China", *Renewable and Sustainable Energy Reviews*, (article in press), 2011.

D. Prasad and M. Snow, "Designing with solar power - A source book for building integrated photovoltaics (BiPV)", The Images Publishing Group Pty Ltd and Earthscan, London, 2005.

M. Raugei and P. Frankl, "Life cycle impacts and costs of photovoltaic systems: Current state of the art and future outlooks", *Energy*, **34** (3), 392-399, 2009.

I. Repins, S. Glynn, J. Duenow, T. J. Coutts, W. K. Metzger and M. A. Contreras, "Required material properties for high-efficiency CIGS modules", *Proceedings of SPIE – The International Society for Optical Engineering*, 7409, art. no. 74090M, 2009.

Rheinzink, "Solar PV Click Roll Cap", 2011, <http://www.rheinzink.com/en/products/roof-systems/solar-systems/solar-pv-click-roll-cap/> (accessed December 1, 2011).

ScienceDaily, "Taking Nature's Cue For Cheaper Solar Power", April 6, 2007, <http://www.sciencedaily.com/releases/2007/04/070405171830.htm> (accessed November 19, 2010).

A. W. Smith and A. Rohatgi, "Ray tracing analysis of the inverted pyramid texturing geometry for high efficiency silicon solar cells", *Solar Energy Materials and Solar Cells*, **29**, 37-49, 1993.

Solar Thermal Magazine, "The Curved Solar Power Rooftop Tile, Homeowners Now Have Better Looking Options", October 23, 2010, <http://www.solarthermalmagazine.com/2010/10/23/the-curved-solar-power-rooftop-tile-homeowners-now-have-better-looking-options/> (accessed November 8, 2011).

SolarPlaza, "Top 10 world's most efficient solar PV modules (mono-crystalline)", July 8, 2011, <http://www.solarplaza.com/top10-crystalline-module-efficiency/> (accessed December 11, 2011).

SolarPower Restoration Systems Inc., "SolarSeal PV Concrete System™", (not dated), <http://www.solarpower-restoration.com/solar-seal-pv-concrete-system.html> (accessed December 9, 2011).

H. Sozer and M. Elneimeiri, "Critical factors in reducing the cost of building integrated photovoltaic (BIPV) systems", *Architectural Science Review*, **50**, 115-121, 2007.

H. Spanggaard and F. C. Krebs, "A brief history of the development of organic and polymeric photovoltaics", *Solar Energy Materials and Solar Cells*, **83**, 125-146, 2004.

S. Strong, "Building Integrated Photovoltaics (BIPV)", Whole Building Design Guide, June 9, 2010, <http://www.wbdg.org/resources/bipv.php> (accessed November 11, 2011).

Swiss BiPV Competence Centre, "Energy from the sun", 2010, [http://www.bipv.ch/index.php?option=com\\_content&view=article&id=213&Itemid=3&lang=en](http://www.bipv.ch/index.php?option=com_content&view=article&id=213&Itemid=3&lang=en) (accessed November 18, 2011).

Swiss BiPV Competence Centre, "Photovoltaic material", 2010, [http://www.bipv.ch/index.php?option=com\\_content&view=article&id=214&Itemid=249&lang=en](http://www.bipv.ch/index.php?option=com_content&view=article&id=214&Itemid=249&lang=en) (accessed November 18, 2011).

T. Tao, Z. Hongfei, H. Kaiyan and A. Mayere, "A new trough solar concentrator and its performance analysis", *Solar Energy*, **85** (1), 198-207, 2011.

The German Energy Society (DGS), "Planning and Installing Photovoltaic Systems - A guide for installers, architects and engineers", Earthscan, 2008.

Underwriters Laboratories Inc., "UL 1703 UL Standard for Safety Flat-Plate Photovoltaic Modules and Panels", 2002.

P. Wawer, J. Müller, M. Fischer, P. Engelhart, A. Mohr and K. Petter, "Latest trends in development and manufacturing of industrial, crystalline silicon solar-cells", *Energy Procedia*, **8**, 2-8, 2011.

C. Wei, Z. Liu and X. Deng, "Application of thermoelectric generation technology in Building-integrated Photovoltaics (BIPV)", *Advanced Materials Research*, 250-253, pp. 2153-2156, 2011.



E. Wesoff, "Update: Solar Junction breaking CPV efficiency records, raising \$30M", Greentech Media, April 15, 2011, <http://www.greentechmedia.com/articles/read/solar-junction-setting-new-cpv-efficiency-records/> (accessed December 9, 2011).

P. Würfel, "The physics of Solar Cells", Wiley-VCH Verlag GmbH & Co., Weinheim, 2005.

L. Yang, Q. H. Ye, A. Ebong, W. T. Song, G. J. Zhang, J. X. Wang and Y. Ma, "High efficiency screen printed bifacial solar cells on monocrystalline CZ silicon", *Progress in Photovoltaics: Research and Applications*, **19**, 275-279, 2011.



## Appendix A – BIPV foil products

Table A: Literature data for building integrated photovoltaic foil products

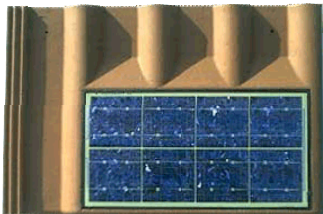
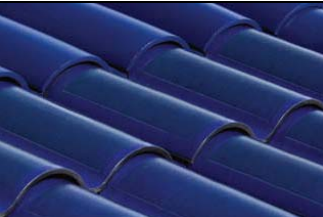

Manufacturer	Illustration	Product	Test	$\eta$ [%]	$U_{oc}$ [V]	$I_{sc}$ [A]	$P_{max}$ [W]	FF	Area [mm x mm]	$P_{max}/area$ [W/m <sup>2</sup> ]	Further information
<b>Alwitra GmbH &amp; Co.</b> P.O. Box 3950 D-54229 Trier Germany  T.: +49 651 9102-0 F.: +49 651 / 91 02-248 alwitra@alwitra.de  www.alwitra.de		EVALON <sub>R</sub> V Solar 408	STC		138.6	5.1	408	0.58	1550 x 6000 x 5.1	43.9	Amorphous silicon cells from Uni-Solar EN 61646
		EVALON <sub>R</sub> V– Solar 272	STC		92.4	5.1	272	0.58	1050 x 6000 x 5.1	43.2	CEC 701 EN 50178 EN 12311-2
		EVALON <sub>R</sub> V– Solar 204	STC		69.3	5.1	204	0.58	1550 x 3360 x 5.1	39.1	EN 12691 EN 1548 EN 13501-1
		EVALON <sub>R</sub> , V– Solar 136	STC		46.2	5.1	136	0.58	1050 x 3360 x 5.1	38.5	ENV 1187/BS 476 Part 3 Inclination > 3°  <a href="http://www.cythelia.fr/images/file/membranes/Brochure_evalon-solar_en.pdf">http://www.cythelia.fr/images/file/membranes/Brochure_evalon-solar_en.pdf</a> [06.12.11]

## Appendix B – BIPV tile products





Table B: Literature data for building integrated photovoltaic tile products

Manufacturer	Illustration	Product	Test	$\eta$ [%]	$U_{oc}$ [V]	$I_{sc}$ [A]	$P_{max}$ [W]	FF	Area [mm x mm]	$P_{max}/area$ [W/m <sup>2</sup> ]	Further information
<b>Solardachstein</b>  www.solardachstein.com  Several partners in various countries distribute their products: <a href="http://www.solardachstein.com/en/faq/partner.html">http://www.solardachstein.com/en/faq/partner.html</a>		STEPdesign	STC		23.15	2.40	1.36 /per cell	0.76 <sup>a</sup>	8 units 100 x 100	136	Polycrystalline silicon cells EN 61215  <a href="http://www.solardachstein.com/en/power/index.html">http://www.solardachstein.com/en/power/index.html</a> [12.12.11]
<b>SRS Energy</b> Corporate Headquarters 2400 Market Street, Suite Five Philadelphia, Pennsylvania 19103 USA  T.: 1267.515.5895  www.srsenergy.com		Solé Powertile			6.3	4.6	15.75	0.54	868 x 457.2 x 76.2	39.7	Amorphous silicon cells from Uni-Solar  <a href="http://www.srsenergy.com/maint/files/SPT16%20Technical%20Specifications%20090310.pdf">http://www.srsenergy.com/maint/files/SPT16%20Technical%20Specifications%20090310.pdf</a> [05.10.10]
<b>Eagle</b> Corporate Office 3546 N. Riverside Avenue Rialto CA 92377 USA  T.: 909-822-6000  www.eagleroofting.com		SolarBlend Roofing Tiles	STC		8.6	7.95	50	0.73	1194 x 432 x 32	96.9	Cells from Suntech UL 1703  <a href="http://www.eagleroofting.com/pdf/ProductLiturature/EagleGreen/Eagle_Green_Brochure_11-2009_FINAL.pdf">http://www.eagleroofting.com/pdf/ProductLiturature/EagleGreen/Eagle_Green_Brochure_11-2009_FINAL.pdf</a> [09.12.10]

<sup>a</sup> Calculated from  $FF = P_{max}/(U_{oc}I_{sc})$  with values of  $U_{oc}$  and  $I_{sc}$  per cell stated by the manufacturer





Manufacturer	Illustration	Product	Test	$\eta$ [%]	$U_{oc}$ [V]	$I_{sc}$ [A]	$P_{max}$ [W]	FF	Area [mm x mm]	$P_{max}/area$ [W/m <sup>2</sup> ]	Further information
<b>Lumeta, Inc.</b> 17182 Armstrong Ave. Irvine, CA 92614 USA  T.: 949.266.1990 F.: 949.266.1960  <a href="http://www.lumetasolar.com/">http://www.lumetasolar.com/</a>		Solar S Tile	STC		7.4	5.2	28	0.73	432 x 968 x 76	67.0	Monocrystalline silicon cells UL 1703 < 600 V IEC 61215 < 1000 V IEC 61730 < 1000 V Inclination > 14°  <a href="http://www.lumetasolar.com/Resources/Documents/Lumeta_Solar_Tile_Eng.pdf">http://www.lumetasolar.com/Resources/Documents/Lumeta_Solar_Tile_Eng.pdf</a> [06.12.11]
		Solar Flat Tile	STC		7.4	5.2	28	0.73	432 x 905 x 35	71.6	
<b>Applied Solar</b> Applied Solar, LLC 3560 Dunhill Street San Diego CA 92121 USA  T.: 858.909.4080 F.: 858.909.4099 inquiries@appliedsolar.com  <a href="http://www.appliedsolar.com">www.appliedsolar.com</a>		3 ft Roofing Tile			6.07	7.76	34	0.72	914 x 432 x 25	86.1	Cells from Suntech UL 1703 Inclination: > 14°  <a href="http://www.appliedsolar.com/roofingsystems/roofingtiles.php">http://www.appliedsolar.com/roofingsystems/roofingtiles.php</a> [09.12.10]
		4 ft Roofing Tile			8.61	7.95	48	0.70	1194 x 445 x 25	90.3	
<b>Sharp</b> 5901 Bolsa Avenue Huntington Beach CA 92647 USA  T.: 1-800-SOLAR-06 sharpsolar@sharpusa.com  <a href="http://www.sharpusa.com/solar">www.sharpusa.com/solar</a>		ND-62RU1	STC		10.8	8.0	62	0.72	1498 x 396 x 34	104.5	Polycrystalline silicon cells UL 1703  <a href="http://www.sharpusa.com/SolarElectricity/SolarProducts/LiteratureDownloads_Archive.aspx">http://www.sharpusa.com/SolarElectricity/SolarProducts/LiteratureDownloads_Archive.aspx</a> [09.12.10]
		ND-62RU1	STC		10.9	7.9	62	0.72			







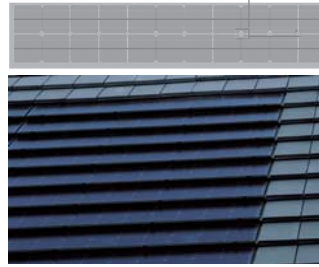

Manufacturer	Illustration	Product	Test	$\eta$ [%]	$U_{oc}$ [V]	$I_{sc}$ [A]	$P_{max}$ [W]	FF	Area [mm x mm]	$P_{max}/area$ [W/m <sup>2</sup> ]	Further information
<b>Solar Century</b> 91-94 Lower Marsh Waterloo London SE1 7AB  T.: +44 (0)20 7803 0100 F.: +44 (0)20 7803 0101 Your-Home@solarcentury.com  www.solarcentury.com	 	C21e Tile	STC	20 /cell	12.0	5.55	52	0.78	1220 x 420 x 30	101.5	Monocrystalline cells IEC 61215 IEC 61730 BPS 7001 prEN 15601 BS 476-3:2004 BS EN 490:2004  <a href="http://www.solarcentury.co.uk/installers-and-roofers/products/solar-tiles/c21e-solar-roof-tiles/">http://www.solarcentury.co.uk/installers-and-roofers/products/solar-tiles/c21e-solar-roof-tiles/</a> [14.12.11]
<b>SunPower</b> SunPower Corporation Corporate Headquarters 77 Rio Robles San Jose, California 95134 T.: 1-800-SUNPOWER (1-800-786-7693)  us.sunpowercorp.com	 	SunTile	STC		14.6	5.65	63	0.76	1499 x 432	97.3	Monocrystalline cells UL 790: Class A UL 997: 110 mph TAS-100: 110 mph Hail impact resistance: 1 inch at 50 mph Inclination 3:12 – 12:12  <a href="http://us.sunpowercorp.com/home-builders/products-services/products/">http://us.sunpowercorp.com/home-builders/products-services/products/</a> [01.12.11]

## Appendix C – BIPV module products



Table C: Literature data for building integrated photovoltaic module products

Manufacturer	Illustration	Product	Test	$\eta$ [%]	$U_{oc}$ [V]	$I_{sc}$ [A]	$P_{max}$ [W]	FF	Area [mm x mm]	$P_{max}/area$ [W/m <sup>2</sup> ]	Further information
<b>Atlantis Energy Systems</b> International Sales, 4517 Harlin Drive Sacramento, CA 95826 USA  T.: 916-438-2930 info@atlantisenergy.com  www.atlantisenergy.com		Sunslates5™	STC		3.70	4.80			400 x 327		Monocrystalline silicon cells Sunslates5™: UL 1703 UL 790  <a href="http://www.atlantisenergy.com/sunslates.html">http://www.atlantisenergy.com/sunslates.html</a> [05.10.10]
		Sunslates6™	STC		3.70	8.0			500 x 368		
		TallSlate™	STC		11.11	5.35			1200 x 400		
		TallSlate™ Grandee	STC		25.05	8.00			1386 x 974		
		MegaSlate®			24	7.70			1320 x 998		
<b>CREATON AG</b> Stephan Führling Dillinger Str. 60 D-86637 Wertingen Germany  T.: +49 (0) 82 72 / 86 - 0 F.: +49 (0) 82 72 / 86 - 500 vertrieb@creaton.de  www.creaton.de		Creaton Solesia			13.86	8.46	90	0.77	1778 x 355	142.6	Monocrystalline silicon cells  <a href="http://www.creaton.de/en/productrange/roof-accessories/photovoltaics/">http://www.creaton.de/en/productrange/roof-accessories/photovoltaics/</a> [06.12.12]



Manufacturer	Illustration	Product	Test	$\eta$ [%]	$U_{oc}$ [V]	$I_{sc}$ [A]	$P_{max}$ [W]	FF	Area [mm x mm]	$P_{max}/area$ [W/m <sup>2</sup> ]	Further information
<b>PV Solar Energy Pty Ltd</b> 28 Florence Street ST PETERS NSW 2044 Australia  T.: +61 (02) 9557 6657 F.: +61 (02) 9557 6692 info@pvsolar.com.au  www.pvsolar.com.au		Sharp					185		1634 x 868 x 15	130.4	
		BP					160		1648 x 841 x 15	115.4	
		BP					75 new		1264 x 588 x 15	100.9	
		BP					75 old		1250 x 583 x 15	102.9	
<b>RHEINZINK</b> Bahnhofstr. 90 45711 Datteln Germany  T.: +49 2363 605-0 F.: +49 2363 605-209 info@rheinink.de  www.rheinink.de		PV Quickstep			17.10	5.12	68 ± 10%	0.78	2000 x 365	93.2	Crystalline silicon cells Inclination 10°-75° IEC 61215  <a href="http://www.rheinink.com/en/products/roof-systems/roof-covering-systems/quick-step-the-rheinink-stepped-roof/">http://www.rheinink.com/en/products/roof-systems/roof-covering-systems/quick-step-the-rheinink-stepped-roof/</a> [06.12.11]
		Solar PV Standing Seam		6	23.10	5.10	68 ± 5%	0.58	2848 x 394	60.6	Amorphous silicon cells from Uni-Solar IEC 61646  <a href="http://www.pvdatabase.org/pdf_prod/SolarPVStandingSeamandClickRollCapSystem_en.pdf">http://www.pvdatabase.org/pdf_prod/SolarPVStandingSeamandClickRollCapSystem_en.pdf</a> [01.12.11]

Manufacturer	Illustration	Product	Test	$\eta$ [%]	$U_{oc}$ [V]	$I_{sc}$ [A]	$P_{max}$ [W]	FF	Area [mm x mm]	$P_{max}/area$ [W/m <sup>2</sup> ]	Further information
<b>Würth Solar</b> Alfred-Leikam-Straße 25 74523 Schwäbisch-Hall Germany  T.: +49 (0) 7 91/9 46 00-0 F.: +49 (0) 7 91/9 46 00-1 19 wuerth-solar@we- online.de  www.wuerth-solar.de		WSG0036E070	STC		42.3	2.4			1205 x 605 x 35		CIS cells These modules can be used building integrated in the system DESIGNline IEC 61646 IEC 61730  <a href="http://www.wuerth-solar.de/solar/en/wuerth-solar/produkte_8/user_modul_genecis/genecis_datenblaetter/GeneCIS_Datenblaetter_1.php">http://www.wuerth-solar.de/solar/en/wuerth-solar/produkte_8/user_modul_genecis/genecis_datenblaetter/GeneCIS_Datenblaetter_1.php</a> 05.12.10]
		WSG0037E070	STC		42.5	2.4			1200 x 600 x 22.75		
		WSG0036E075	STC		43.1	2.4			1205 x 605 x 35		
		WSG0037E075	STC		43.4	2.4			1200 x 600 x 22.75		
		WSG0036E080	STC		44	2.5			1205 x 605 x 35		
<b>Abakus Solar AG</b> Leithestraße 39 D-45886 Gelsenkirchen Germany  www.abakus-solar.de		Peak On P220-60	STC	13.2 <sup>b</sup>	36.77 <sup>b</sup>	8.22 <sup>b</sup>			1667 x 1000 x 40		Polycrystalline silicon cells IEC 61215 Ed.2 IEC 61730  <a href="http://www.abakus-solar.com/en/pv/modules/components/products/modules.html">http://www.abakus-solar.com/en/pv/modules/components/products/modules.html</a> [05.10.10]
			NOCT	12.73 <sup>b</sup>	33.93 <sup>b</sup>	6.65 <sup>b</sup>					
		Peak On P235-60	STC	14.6 <sup>b</sup>	37.21 <sup>b</sup>	8.48 <sup>b</sup>			1630 x 1000 x 40		
			NOCT	13.93 <sup>b</sup>	34.44 <sup>b</sup>	6.86 <sup>b</sup>					
		ANT P6-60-230	STC	14.07 <sup>b</sup>	36.77 <sup>b</sup>	8.42 <sup>b</sup>			1658 x 986 x 50		
			NOCT	13.57 <sup>b</sup>	33.91 <sup>b</sup>	6.93 <sup>b</sup>					

<sup>b</sup> The values are retrieved from the specific  $P_{nom}$ . For example  $P_{nom} = 220$  Wp for P220-60



Manufacturer	Illustration	Product	Test	$\eta$ [%]	$U_{oc}$ [V]	$I_{sc}$ [A]	$P_{max}$ [W]	FF	Area [mm x mm]	$P_{max}/area$ [W/m <sup>2</sup> ]	Further information
<b>SOLON SE</b> Am Studio 16 12489 Berlin Germany  T.: + 49 30 81879 – 0 F.: + 49 30 81879 - 9999  components@solon.com  www.solon.com		SOLON Black 160/05	STC	13.67	44.53	5.01	175	0.78 <sup>c</sup>	1754 x 850 x 27	117.4	72 cells, monocrystalline silicon IEC 61730 IEC 61215 Ed. 2 Inclination: 22°-60°  <a href="http://www.abakus-solar.com/fileadmin/user_upload/Datenblaetter_Module/Solon/EN_DB_SOLON_Black_160_05_en.pdf">http://www.abakus-solar.com/fileadmin/user_upload/Datenblaetter_Module/Solon/EN_DB_SOLON_Black_160_05_en.pdf</a> [13.12.11]
			STC	13.28	44.28	4.97	170	0.77 <sup>c</sup>		114.0	
			STC	12.89	44.03	4.93	165	0.76 <sup>c</sup>		110.7	
			STC	12.50	43.78	4.89	160	0.75 <sup>c</sup>		107.3	
			STC	12.11	43.53	4.85	155	0.73 <sup>c</sup>		104.0	
<b>DuPont</b> DuPont de Nemours (Luxembourg) S.à r.l. Rue Général Patton L-2984 Luxembourg  T.: +33 (0)1 41 97 45 00  www.gevity.dupont.com		Gevity	STC	17.7	24.20-24.43	8.77-8.87			1452.9 x 929		Monocrystalline silicon cells IEC 61215 IEC 61730-1 IEC 61730-2  <a href="http://www2.dupont.com/Photovoltaique_Integre/fr_FR/assets/downloads/DuPont_BIPV_flyer3.pdf">http://www2.dupont.com/Photovoltaique_Integre/fr_FR/assets/downloads/DuPont_BIPV_flyer3.pdf</a> [06.12.11]

<sup>c</sup> The values are calculated from  $FF = P_{max}/(U_{oc}I_{sc})$

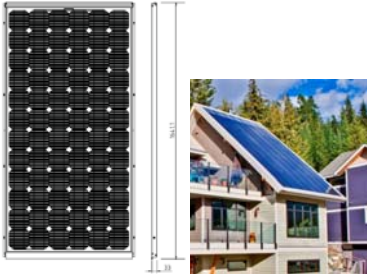
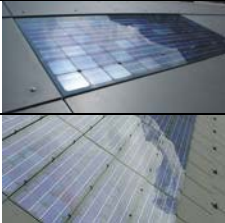
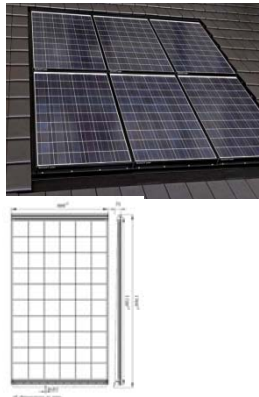
Manufacturer	Illustration	Product	Test	$\eta$ [%]	$U_{oc}$ [V]	$I_{sc}$ [A]	$P_{max}$ [W]	FF	Area [mm x mm]	$P_{max}/area$ [W/m <sup>2</sup> ]	Further information
<b>SYSTAIC AG</b> Kasernenstr. 27 D-40213 Düsseldorf Germany  T.: +49 211 828 559-0 F.: +49 211 828 559-29 systaic@systaic.com  www.systaic.com		PV-laminate 215 W	STC			8.11			1674 x 984 x 5		Monocrystalline silicon cells EN 61215 EN 61730-1 EN 61730-2  <a href="http://www.systaic.com/uploads/tx_sbdownloader/2010-02-10_systaic_PV-L_215-235W_EN.pdf">http://www.systaic.com/uploads/tx_sbdownloader/2010-02-10_systaic_PV-L_215-235W_EN.pdf</a> [05.11.10]  <a href="http://www.systaic.com/uploads/tx_sbdownloader/2010-03-29_systaic_PV-M_215-235W_EN.pdf">http://www.systaic.com/uploads/tx_sbdownloader/2010-03-29_systaic_PV-M_215-235W_EN.pdf</a> [05.11.10]
		PV-laminate 220 W	STC			8.25					
		PV-laminate 225 W	STC			8.31					
		PV-laminate 230 W	STC			8.48					
		PV-laminate 235 W	STC			8.60					
		PV-module 215 W	STC			8.11			1680 x 990 x 50		
		PV-module 220 W	STC			8.25					
		PV-module 225 W	STC			8.31					
		PV-module 230 W	STC			8.48					
		PV-module 235 W	STC			8.60					

Manufacturer	Illustration	Product	Test	$\eta$ [%]	$U_{oc}$ [V]	$I_{sc}$ [A]	$P_{max}$ [W]	FF	Area [mm x mm]	$P_{max}/area$ [W/m <sup>2</sup> ]	Further information
<b>Suntech</b> Mühlentalstrasse 36 8200 Schaffhausen Switzerland  T.: + 41 (0) 52 6320090 F.: + 41 (0) 52 6320099 sales.europe@suntech-power.com www.suntech-power.com		MSZ-190J-D	STC		45.2	5.62	190	0.75	1641 x	139 <sup>e</sup>	Monocrystalline silicon cells IEC 61215 IEC 61730  <a href="http://eu.suntech-power.com/images/stories/pdf/datasheets/English/suntech-justroof.pdf">http://eu.suntech-power.com/images/stories/pdf/datasheets/English/suntech-justroof.pdf</a> [12.12.11]
		MSZ-195J-D	STC		45.4	5.69	195	0.75	834.5 x	143 <sup>e</sup>	
		MSZ-185J-C	STC		45.0	5.43	185	0.76	33	136 <sup>e</sup>	
		MSZ-190J-C	STC		45.2	5.62	190	0.75		139 <sup>e</sup>	
		MSZ-95J-DH	STC		22.6	5.62	95	0.75	879 <sup>d</sup> x	132 <sup>e</sup>	
		MSZ-90J-CH	STC		22.4	5.29	90	0.76	834.5 x	125 <sup>e</sup>	
										33	
<b>Eternit AG</b> CH 8867 Niederurnen Switzerland  T.: +41 (0)55 617 11 11 info@eternit.ch  www.eternit.ch		Photovoltaic INTEGRAL PLAN					355				<a href="http://www.eternit.ch/en/products-and-solutions/roof/solar-force-systems/">http://www.eternit.ch/en/products-and-solutions/roof/solar-force-systems/</a> [05.10.10]
		SUNJOULE photovoltaic module					45		720 x 400	156.3	
<b>Schott Solar AG</b> Hattenbergstrasse 10 55122 Mainz Germany  T.: +49 (0)6131/66-14105 F.: +49 (0)6131/66-14105 solar.sales@schottsolar.com  www.schottsolar.de		InDax 214	STC	12.5	36.3	8.04			1769 x 999 x 75		Polycrystalline silicon cells IEC 61730 IEC 61215  <a href="http://www.schottsolar.com/global/products/photovoltaics/schott-indax-185235/">http://www.schottsolar.com/global/products/photovoltaics/schott-indax-185235/</a> [06.12.11]
			NOCT		33.1	6.44					
		InDax 225	STC	13.1	36.7	8.24					
			NOCT		33.5	6.60					

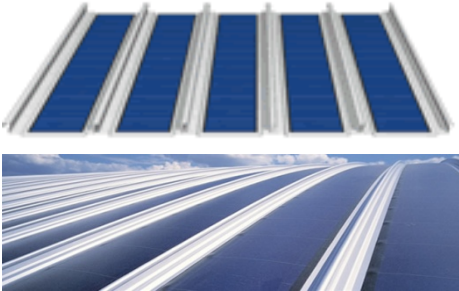
<sup>d</sup> Half size - Applies to MSZ-95J-DH and MSZ-90J-CH<sup>e</sup> Stated by the manufacturer, other P<sub>max</sub>/area-values are calculated from the stated P<sub>max</sub> and area values







Manufacturer	Illustration	Product	Test	$\eta$ [%]	$U_{oc}$ [V]	$I_{sc}$ [A]	$P_{max}$ [W]	FF	Area [mm x mm]	$P_{max}/area$ [W/m <sup>2</sup> ]	Further information
<b>Kalzip / Corus</b> Haydock Lane, Haydock St. Helens WA11 9TY Merseyside United Kingdom  T.: +44 (0) 1942 295 500 F.: +44 (0) 1942 295 508 enquiries.uk@kalzip.com  www.kalzip.com		AluPlusSolar PVL-136			46.2	5.1			5500 x 1000		Amorphous silicon cells from Uni-Solar Inclination: 3°-60°  <a href="http://www.kalzip.com/PDF/uk/Kalzip-Solar-Systems.pdf">http://www.kalzip.com/PDF/uk/Kalzip-Solar-Systems.pdf</a> [10.12.10]
		AluPlusSolar PVL-68			23.1	5.1					
<b>Solar Century</b> 91-94 Lower Marsh Waterloo London SE1 7AB  T.: +44 (0)20 7803 0100 F.: +44 (0)20 7803 0101 Your-Home@solarcentury.com  www.solarcentury.com		C21e Slate	STC	20 /cell	12.0	5.55	52	0.78	1174 x 318 x 14 <sup>f</sup>	139.3	Monocrystalline silicon cells Active area same as C21e Tile prEN 15601 BS 476-3:2004  <a href="http://www.solarcentury.co.uk/installers-and-roofers/products/solar-tiles/c21e-solar-roof-slates/">http://www.solarcentury.co.uk/installers-and-roofers/products/solar-tiles/c21e-solar-roof-slates/</a> [14.12.10]

<sup>f</sup> Active area



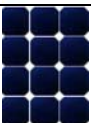



## Appendix D – Solar cell glazing products

Table D: Literature data for solar cell glazing products

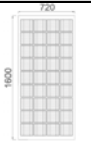

Manufacturer	Illustration	Product	Test	$\eta$ [%]	$U_{oc}$ [V]	$I_{sc}$ [A]	$P_{max}$ [W]	FF	Area [mm x mm]	$P_{max}/area$ [W/m <sup>2</sup> ]	Further information
<b>Sapa Building System</b> Industrielaan 17 8810 Lichtervelde Belgium  T.: +32 51 729 666 F.: +32 51 729 647 info@sapagroup.com  www.sapagroup.com		Amorphous silicon thin film		5 per cell			32 per cell		576 x 976 per cell	50 <sup>§</sup> (given)	The producer offers customized solutions. The options are opaque panels and see-through panels. Distances between cells can vary from 3-50 mm.  <a href="http://www.sapagroup.com/Companies/Sapa%20Building%20System%20AB/Pictures/brochures/Solar_BIPV_low.pdf">http://www.sapagroup.com/Companies/Sapa%20Building%20System%20AB/Pictures/brochures/Solar_BIPV_low.pdf</a> [06.12.11]
		Polycrystalline		16 per cell			1.46 – 3.85 per cell		156 x 156 / 125 x 125 per cell	120 <sup>§</sup> (given)	
		Monocrystalline high efficient		22 per cell			2.90 – 3.11 per cell		125 x 125 per cell	155 <sup>§</sup> (given)	
		Amorphous silicon thin film 10% or 20% opacity		4 per cell			27 per cell		576 x 976 per cell	40-45 <sup>§</sup> (given)	
		Monocrystalline semi-transparent		17 per cell			1.90 – 2.20 per cell		125 x 125 per cell	105 <sup>§</sup> (given)	
		Monocrystalline high efficient 25 mm distance 36% transparency		22 per cell						135 <sup>§</sup> (given)	
		Polycrystalline 50 mm distance 42.5% transparency		16 per cell						82 <sup>§</sup> (given)	

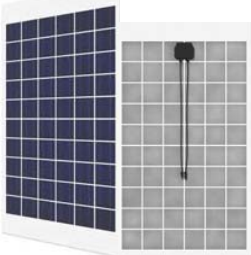
<sup>§</sup> Stated by the manufacturer, other Pmax/area-values are calculated from the stated Pmax and area values

Manufacturer	Illustration	Product	Test	$\eta$ [%]	$U_{oc}$ [V]	$I_{sc}$ [A]	$P_{max}$ [W]	FF	Area [mm x mm]	$P_{max}/area$ [W/m <sup>2</sup> ]	Further information
<b>VIDURSOLAR</b> Poligono industrial Bufalvent C/ Edison, num 8-14 08243 MANRESA Barcelona Spain  T.: + 34 93 874 86 50 F.: + 34 93 873 64 76 vidursolar@vidursolar.es  www.vidursolar.es		Model FV VS16 C36 P120 Transparency approx. 16%	STC		21.6	7.63			1600 x 720 x 11.5		Polycrystalline silicon cells Vidursolar also offers customized modules regarding shape, cell type, colour and distance between cells.  <a href="http://www.vidur.es/solar_pridefinidos_detalle.php?id=1">http://www.vidur.es/solar_pridefinidos_detalle.php?id=1</a> [06.12.11]
		Model FV VS16 C54 P180 Transparency approx. 16%	STC		32.4	7.63			1600 x 1056 x 11.5		
		Model FV VS36 C54 P180 Transparency approx. 36%	STC		32.4	7.63			1834 x 1196 x 11.5		
		Model FV VS41 C60 P200 Transparency approx. 41%	STC		35.7	7.63			2220 x 1196 x 11.5		
<b>Abakus Solar AG</b> Leithestraße 39 D-45886 Gelsenkirchen Germany  www.abakus-solar.de		Peak In P210-60  Transparency: 25%	STC		36.50 <sup>h</sup>	7.70 <sup>h</sup>			2000 x 1066 x 11		Polycrystalline silicon cells Abakus also offers customized modules regarding shape, cell type, colour and distance between cells. IEC 61215 IEC 61730  <a href="http://www.abakus-solar.com/fileadmin/user_upload/Datenblaetter_Module/a2peak/PeakIn_P210_60_Factsheet_2010_english.pdf">http://www.abakus-solar.com/fileadmin/user_upload/Datenblaetter_Module/a2peak/PeakIn_P210_60_Factsheet_2010_english.pdf</a> [06.12.11]

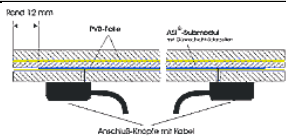
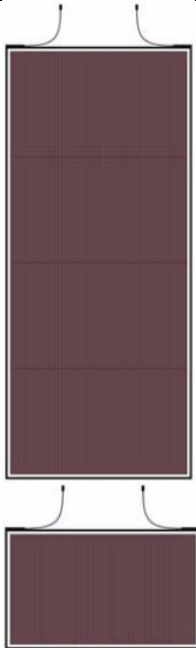
<sup>h</sup> The values are retrieved from the specific  $P_{nom}$ . For example  $P_{nom} = 210$  W for P210-60



Manufacturer	Illustration	Product	Test	$\eta$ [%]	$U_{oc}$ [V]	$I_{sc}$ [A]	$P_{max}$ [W]	FF	Area [mm x mm]	$P_{max}/area$ [W/m <sup>2</sup> ]	Further information
<b>Glaswerke Arnold GmbH &amp; Co KG</b> Neuseser Strasse 1 D-91732 Merkendorf Germany  T.: +49 (0)9826 - 656 - 0 F.: +49 (0)9826 - 656 - 400 SolAr@Glaswerke-Arnold.de  www.voltarlux.de		Voltarlux®-ASI-T-Mono 2x-fach Transparency 10%	STC		49	1.80	48	0.54	2004 x 627 x 17	38.2	Amorphous silicon cells from Schott Solar (ASI®THRU) UL 1703  <a href="http://www.voltarlux.de/cms.asp?AE=1&amp;IDN=60&amp;Plugin=&amp;H=%27157%27&amp;T=0&amp;Sprache=en">http://www.voltarlux.de/cms.asp?AE=1&amp;IDN=60&amp;Plugin=&amp;H=%27157%27&amp;T=0&amp;Sprache=en</a> [12.12.11]
		Voltarlux®-ASI-T-Mono 4-fach Transparency 10%	STC		93	1.97	100	0.55	2358 x 1027 x 18	41.3	
<b>Schott Solar</b> Hattenbergstrasse 10 55122 Mainz Germany  T.: +49 (0)6131/66-14105 F.: +49 (0)6131/66-14105 solar.sales@schottsolar.com  www.schottsolar.de		ASI® THRU-1-L	STC	6	111	0.55	48	0.79	1122 x 690 x 16	62.0	Amorphous silicon cells  ASI® THRU glass has a transparency of approx. 10%  U-value: 1.1 W/m <sup>2</sup> K  <a href="http://www.us.schott.com/architecture/english/download/asi_glass_brochure_us-2.pdf">http://www.us.schott.com/architecture/english/download/asi_glass_brochure_us-2.pdf</a> [01.12.11]
		ASI® THRU-1-IO	STC	6	111	0.55	48	0.79	1122 x 696 x 34	61.5	
		ASI® THRU-2-L	STC	6	111	1.11	95	0.77	1122 x 1331 x 16	63.6	
		ASI® THRU-2-IO	STC	6	111	1.11	95	0.77	1122 x 1337 x 34	63.3	
		ASI® THRU-3-L	STC	6	111	1.66	143	0.78	1122 x 1972 x 16	64.6	
		ASI® THRU-3-IO	STC	6	111	1.66	143	0.78	1122 x 1978 x 34	64.4	
		ASI® THRU-4-L	STC	6	111	2.22	190	0.77	1122 x 2613 x 16	64.8	
		ASI® THRU-4-IO	STC	6	111	2.22	190	0.77	1122 x 2619 x 34	64.7	



Manufacturer	Illustration	Product	Test	$\eta$ [%]	$U_{oc}$ [V]	$I_{sc}$ [A]	$P_{max}$ [W]	FF	Area [mm x mm]	$P_{max}/area$ [W/m <sup>2</sup> ]	Further information
<b>PV Glaze</b> 26 The Downs Delamere Park Cuddington, Cheshire CW8 2XD, U.K.  T.: +44 (0)1606 301847 info@pvglaze.com  www.pvglaze.com		EA1 Panel			196	2.8	340 ± 5%		2600 x 2200 single	59.4	SunFab™ amorphous technology  <a href="http://www.pvglaze.com/PVGD_Brochure.pdf">http://www.pvglaze.com/PVGD_Brochure.pdf</a> [02.12.11]
		PA1 Panel			289	2.46	450 ± 5%		2600 x 2200 tandem	78.7	
<b>Schueco UK Limited</b> Whitehall Avenue, Kingston, Milton Keynes, MK10 0AL T.: +44 (0)1908282111 F.: +44 (0)1908282124 mkinfobox@schuco.com www.schueco.com		Schüco Prosol TF							Various	50-70 <sup>i</sup> (given)	Thin film technology  <a href="http://www.schueco.com/web/fassade/modul_en/fenster_und_fassade/modul">http://www.schueco.com/web/fassade/modul_en/fenster_und_fassade/modul</a> [02.12.11]

<sup>i</sup> Stated by the manufacturer, other Pmax/area-values are calculated from the stated Pmax and area values

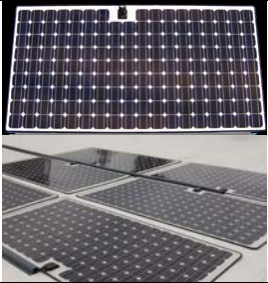
## Appendix E – BAPV products

Table E: Literature data for some building attached photovoltaic products

Manufacturer	Illustration	Product	Test	$\eta$ [%]	$U_{oc}$ [V]	$I_{sc}$ [A]	$P_{max}$ [W]	FF	Area [mm x mm]	$P_{max}/area$ [W/m <sup>2</sup> ]	Further information
<b>SolarFrameWorks Co</b> 765 Moss Street Golden, CO 80401 USA  T.: 1-888-90-SOLAR  www.solarframeworks.com		BIPV CoolPly™									Inclination < 2:12  <a href="http://www.solarframeworks.com/pdf/SFW_CP_BIPV_SS_web.pdf">http://www.solarframeworks.com/pdf/SFW_CP_BIPV_SS_web.pdf</a> [13.12.11]
<b>Lumeta, Inc.</b> 17182 Armstrong Ave. Irvine, CA 92614 USA  T.: 949.266.1990 F.: 949.266.1960  www.lumetasolar.com		PowerPly	STC	13.8	98.9	5.33	400 ± 5%	0.76	2360 x 1230 x 10	137.8	Monocrystalline silicon cells Inclination < 10° UL 1703 IEC 61215 IEC 61730  <a href="http://www.lumetasolar.com/Resources/Documents/PowerPly%20400_093010.pdf">http://www.lumetasolar.com/Resources/Documents/PowerPly%20400_093010.pdf</a> [06.12.11]
<b>Hauptsitz</b> Ernst Schweizer AG, Metallbau Bahnhofplatz 11 CH-8908 Hedingen Switzerland  T: +41 44 763 61 11 F: +41 44 763 61 19  www.schweizer-metallbau.ch		SunPower 220 Solar Panel	STC NOCT	17.7	48.6 45.4	5.75 4.66			1559 x 798		All-back contact monocrystalline silicon cells IEC 61215 IEC 61730  <a href="http://www.schweizer-metallbau.ch/fileadmin/user_upload/00_Produkte/80_Sonnenenergie-Systeme/pdf_f/pdf_e/Sunpower_black_e.pdf">http://www.schweizer-metallbau.ch/fileadmin/user_upload/00_Produkte/80_Sonnenenergie-Systeme/pdf_f/pdf_e/Sunpower_black_e.pdf</a> [05.10.10]

Manufacturer	Illustration	Product	Test	$\eta$ [%]	$U_{oc}$ [V]	$I_{sc}$ [A]	$P_{max}$ [W]	FF	Area [mm x mm]	$P_{max}/area$ [W/m <sup>2</sup> ]	Further information
<b>Uni-Solar</b> Tour Albert 1er 65, avenue de colmar 92507 Rueil Malmaison Cedex France  T.: +33.1.74.70.46.24 F.: +33.1.41.39.00.22 franceinfo@uni-solar.com  www.uni-solar.com		PVL-68	STC		23.1	5.1	68	0.58	2849 x	60.6	Amorphous silicon cells Inclination: 3°-60° UL 1703 IEC 61646 IEC 61730  <a href="http://www.uni-solar.com/products/commercial-products/pvl/">http://www.uni-solar.com/products/commercial-products/pvl/</a> [06.12.11]
			NOCT 46°		21.1	4.1	53	0.61	394 x 4	47.2	
		PVL-136	STC		46.2	5.1	136	0.58	5486 x	62.9	
			NOCT 46°		42.2	4.1	105	0.61	394 x 4	48.6	
		PVL-144	STC		46.2	5.3	144	0.59	5486 x	66.6	
			NOCT 46°		42.2	4.3	111		394 x 4	51.4	
<b>Isoton</b> C/ Montalbán,9 28014 Madrid Spain  T.: +34 91 414 78 00 F.: +34 91 414 79 00 isofoton@isofoton.com  www.isofoton.com		ISF-230	STC	13.9	36.6	8.36	230	0.75	1667 x 994 x 45	138.8	Monocrystalline silicon cells 60 cells in serial (Note that the photo to the left depicts 54 cells.) Uncertainty regarding how the product is mounted IEC 61215 IEC 61730  <a href="http://www.isofoton.com/technical/material/pdf/productos/fotovoltaica/modulos/grupos/ISF_230-240_ing.pdf">http://www.isofoton.com/technical/material/pdf/productos/fotovoltaica/modulos/grupos/ISF_230-240_ing.pdf</a> [06.12.11]
			NOCT		33.1	6.73	163	0.73		98.4	
		ISF-235	STC	14.2	36.8	8.44	235	0.76		141.8	
			NOCT		33.3	6.78	167	0.74		100.8	
		ISF-240	STC	14.5	37.1	8.45	240	0.77		144.8	
			NOCT		33.6	6.80	170	0.74		102.6	