

Report

Yme – Weathering properties and behaviour at sea

In relation to oil spill response

Author(s)

Kristin Rist Sørheim

Kaja Cecilie Hellstrøm, Oddveig M. Bakken, Thor-Arne Pettersen

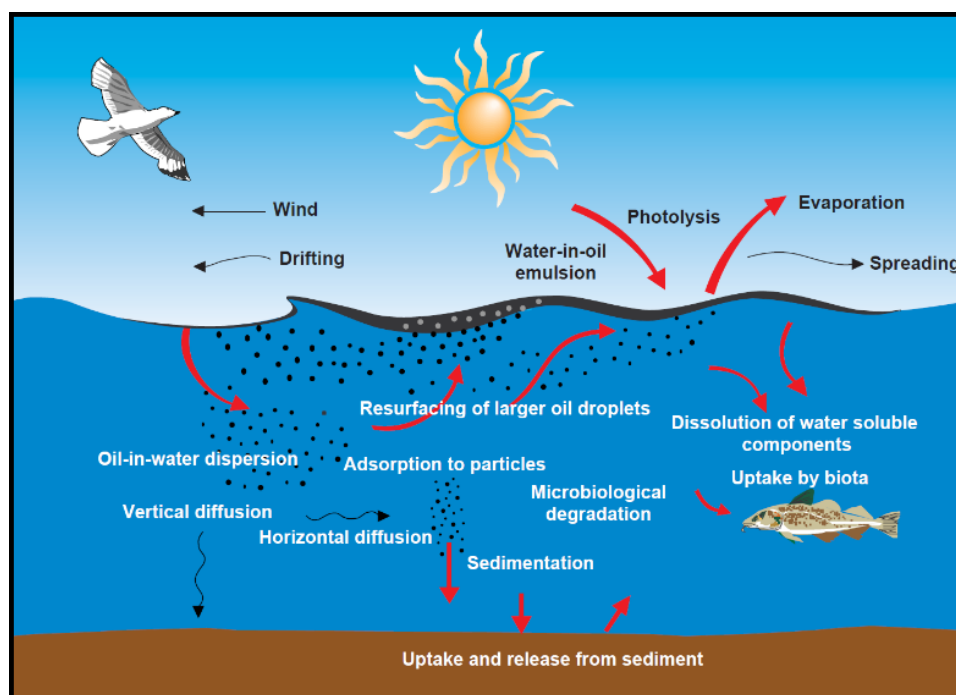

SINTEF Ocean AS

Address:
Postboks 4762 Torgarden
NO-7465 Trondheim
NORWAY

Switchboard: +47 46415000

Enterprise /VAT No:
NO 937 357 370 MVA

Report

Yme – Weathering properties and behaviour at sea

In relation to oil spill response

REPORT NO.	PROJECT NO.	VERSION	DATE
OC2023 A-060	302007544	1.0	2023-10-17

KEYWORDS:Yme crude oil
Weathering properties
Oil spill response**AUTHOR(S)**Kristin Rist Sørheim
Kaja Cecilie Hellstrøm, Oddveig M. Bakken, Thor-Arne Pettersen**CLIENT(S)**

Sonja Urdal Alsvik

CLIENT'S REF.

Repsol Norge AS

NUMBER OF PAGES/APPENDICES:

83 incl. 4 Appendices

CLASSIFICATION

Open

CLASSIFICATION THIS PAGE

Open

ISBN

978-82-7174-456-4

ABSTRACT

A standardized bench-scale (5 and 13 °C) including dispersibility testing has been conducted on the Yme crude oil. A supplementary meso-scale flume testing was also included at 13 °C. The laboratory data were further used as input to the SINTEF Oil Weathering Model (OWM) for weathering and dispersibility predictions from a surface release of Yme at sea at 5 and 15 °C, reflecting winter and summer conditions. The weathering properties of Yme are also discussed in relation to oil spill response.

**PREPARED BY**

Kristin Rist Sørheim



Kristin R. Sørheim (Oct 17, 2023 15:45 GMT+2)

CHECKED BY

Per S. Daling

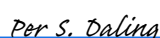

Per S. Daling (Oct 18, 2023 08:12 GMT+2)

APPROVED BY

Trond Røvik Størseth



Trond R. Størseth (Oct 18, 2023 08:45 GMT+2)

Document History

VERSION	DATE	VERSION DESCRIPTION
0.1	2023-09-04	Draft version

1.0	2023-10-17	Final version
-----	------------	---------------

Table of Contents

1	Executive summary	6
2	Introduction	8
3	Bench-scale laboratory testing	9
3.1	Gas chromatographic (GC-FID) characterization	9
3.2	Asphaltenes and wax content	12
3.3	Physical properties of the fresh and weathered residues	12
3.4	Emulsifying properties	14
3.4.1	Emulsification	14
3.4.2	Kinetics of water uptake	15
3.4.3	Efficiency of emulsion breaker and stability of emulsions	16
3.5	Emulsion viscosities and yield stress	17
3.6	Chemical dispersibility	19
3.6.1	Screening testing of dispersants	19
3.6.2	Dosage testing	20
3.6.3	Systematic dispersant testing and dispersibility limits	21
4	Meso-scale flume testing	23
4.1	Evaporation	23
4.2	Water uptake	24
4.3	Emulsion viscosity	25
4.4	Mass balance	25
4.5	In-situ chemical dispersion	26
4.6	Observations from the flume testing	27
4.7	Remarks from the meso-scale flume testing of Yme	31
5	Predictions with SINTEF Oil Weathering Model (OWM)	32
5.1	Description of SINTEF OWM	32
5.2	Predictions of weathering properties of Yme	33
5.3	Predictions of Yme crude oil weathering properties	35
6	Comparison of OWM predictions	44
6.1	Evaporative loss	44
6.2	Flash point	45
6.3	Pour point	46
6.4	Water uptake	47
6.5	Emulsion viscosity	48
6.6	Surface oil and emulsion	48

7	Weathering properties and response of Yme (surface release)	50
7.1	Oil properties	50
7.2	Flash point – Fire/explosion hazard	50
7.3	Solidification.....	51
7.4	Emulsion formation.....	51
7.5	Entrained oil and evaporation	52
7.6	Film thickness from surface release.....	53
7.7	Mechanical recovery by boom and skimmer	53
7.8	Mechanical dispersion by high-capacity water flushing	55
7.9	Chemical dispersion	55
8	Summary of response options of Yme	57
9	Categorization of Yme to other Norwegian oil (oil map)	58
10	References	60
A	The behaviour of oil on the sea surface	62
A.1	The chemical composition of crude oils and condensates	62
A.2	Main oil categories related to weathering	63
A.3	Physical properties of crude oils	63
A.3.1	Rheological properties.....	64
A.3.2	Pour point	65
A.3.3	Distillation curve	65
A.3.4	Flash point	65
A.4	The behaviour of crude oil spilled at sea	66
A.4.1	Evaporation.....	67
A.4.2	Spreading	67
A.4.3	Drift of an oil slick	68
A.4.4	Water-in-oil (w/o) emulsion	69
A.4.5	Oil-in-water (o/w) dispersion	71
A.4.6	Water solubility	71
A.4.7	Photo-oxidation	71
A.4.8	Biodegradation	71
A.4.9	Sedimentation	72
A.4.10	Deep water releases	72
A.4.11	Shallow releases	74
B	Experimental setup and HSE	75
B.1	Oil sample and test temperature.....	75
B.2	Water content.....	75
B.3	Small-scale laboratory testing.....	75
B.4	Evaporation.....	76
B.5	Physical and chemical analysis.....	76

B.6	Emulsification properties	77
B.7	Chemical dispersibility testing	77
B.8	Meso-scale laboratory testing	78
C	Input data to SINTEF Oil Weathering Model (OWM)	81
D	Chemical characterization – OSCAR composition file	83

1 Executive summary

Spilled oils undergo changes when weathered on the sea surface. These changes affect oil behaviour and consequently oil spill preparedness. Oil weathering varies over time and with different environmental conditions. The lifetime of an oil spill at sea depends on the oil's properties, emulsification, release scenario, and environmental conditions (temperature, wind, waves). Natural dispersion and evaporation are the main weathering processes that reduced oil volumes of oil spills from the sea surface. Based on input from the experimental weathering data of the Yme crude oil, the SINTEF Oil Weathering Model (OWM) has been used to predict the properties of oil as it weathered over time. This summary gives a brief overview of the main changes predicted for Yme when weathered on the sea surface.

Compared to many other Norwegian crude oils, this weathering study of Yme shows the following properties relevant for the behaviour if spilled at sea with film thickness that is sufficient high to emulsify, i.e., typically higher than 0.1 mm.

- Yme is a paraffinic crude oil with a density of 0.842 g/mL with a volatile loss of 38 vol.% for the 250°C+ residue that cause a moderate degree of evaporation at sea. For example, after 12 hours, the evaporative loss is in the range of 30-33 % at 10 m/s wind speed at winter and summer conditions, respectively.
- The combination of wax content (3.4 wt.%), asphaltenes (0.54 wt.%), Yme forms stable water-in-oil emulsions with high water uptake to about 75-80 vol%. in both winter and summer conditions.
- The emulsion formed are expected to have a high persistency on the sea surface, e.g., the predictions indicate a lifetime of 2-3 days at 15 m/s wind speed. In calmer weather conditions the lifetime is predicted to be >5 days.
- About 65% of the oil can remain on the sea surface in very calm weather conditions (2 m/s wind speed) after 5 days.
- The overall volume of the spilled oil can increase 2-2.5 times relative to the volume due to emulsification.
- Un-emulsified residues at sea may form semi-solid lumps/materials particularly in calm sea conditions (<2-5 m/s wind speeds) due to high pour points but this phenomenon is expecting to be less pronounced in summer temperatures than in colder seawater temperatures.

Risk of fire /explosion hazard in oil spill response:

If free gas is not associated with an oil release (e.g., surface release of stabilized oil at 1 atm.), the flash point of the oil is the most important parameter when evaluating the potential for fire /explosion hazard. In such cases the flash point of the oil assumes to reach the ambient water temperature within a short time. The fire hazard, based on the evaporated volatiles from the oil, may be high if the flash point of the free-drifting oil is below the sea temperature.

The flash points for Yme are expected to surpass the sea temperature within a few minutes at 5 and 15 °C, predicted with the standardized surface release (80 m³/ h). Moreover, some storage tanks in vessels engaged in oil recovery operations may not be classified to carry liquids with flash points lower than 60 °C. For Yme, the tank storage limit is predicted to be surpassed within 3 hours in summer temperatures and within 6 hours in winter temperatures, for the calmest wind conditions (2 m/s), and shorter time for higher wind speeds and higher temperatures. For oil recovery vessels (e.g., NOFO's ORO vessels) with A class certification for transport of liquids (Class I/II, flash point <60 °C), there should not be any risks in storing the recovered emulsion in such tanks.

A "safety" zone should be established early and downwind from the spill site before any response actions in case of an acute oil spill involving free gas. In a response operation, explosimeters should always be utilized to measure concentrations of free gas to minimize the risk for fire and explosion hazard at the spill site.

Effect of adding emulsion breaker:

The emulsions of Yme were stable but released about 58-95% of the incorporated water at winter conditions when adding concentrations 2000 ppm by weight of the emulsion breaker Aerosol OT-SE surfactant, and

similar 90-98 % effectiveness at summer conditions. The highest concentration (2000 ppm) of emulsion breaker was shown to be more effective than a lower concentration of 500 ppm. Use of emulsion breaker may therefore effectively be used during an oil spill operation to remove or reduce water from the recovered oil/emulsion which minimizes the storage volume. Emulsion breakers are normally injected at the skimmer head prior to transferring the collected oil/water to storage tanks.

Solidification of residue at sea:

Increased weathering potentially increases the high pour points to the point of solidification (elastic properties) at the sea surface. Solidification typically arises in calm sea conditions (i.e., non-breaking waves) when the pour point of the oil is 5-15 °C above the seawater temperature. In such cases, if solidified (low emulsified/water free) lumps are observed on the sea surface, a lower dispersant effectiveness is likely.

Mechanical recovery:

The risk for boom leakage in a mechanical recovery operation is more of a concern for low viscous emulsions (lower than 1000 mPa.s) compared to emulsions that are more viscous. Boom leakage is also influenced by other factors such as operational speed and weather conditions. The predictions indicate that the emulsion viscosities of Yme surpass 1000 mPa.s between 3-6 hours at 10 m/s wind speed at 5 and 15 °C, but the time may be stretched up to about 12 hours to 1-day for very low wind speed (2 m/s). Moreover, viscosities larger than 20 000 mPa.s are known to reduce the flowability of the oil/emulsion when using traditional weir skimmers. For example, Yme has emulsion viscosities lower than this limit up to a about 5 days at summer conditions, and 12 hours-1.5 days at winter conditions for 10-15 m/s wind speeds. In cases if the emulsion exceeds 20 000 mPa.s, that can be the case particularly in low temperatures, a combination of weir and HiVisc. skimmers may be considered. Overall, Yme is expected to have a wide window of opportunity for use of traditional weir-skimmer head.

Chemical dispersion (viscosity limits):

Yme is expected to have a good potential for chemical dispersion with use of Dasic Slickgone NS (DOR; dispersant-to-oil ratio 1:25) for viscosities <1500 mPa.s based on the low-energy test (IFP), and poorly dispersible for viscosities >10 000 mPa.s based on the high-energy test (MNS). In the field, if the oil is reduced dispersible i.e., viscosities between 1500-10 000 mPa.s, additional energy e.g., thrusters, Fire Fighting (Fi-Fi) systems, higher DOR by repeated dispersant application may increase the efficacy of the dispersant treatment.

High-capacity water flushing (mechanical dispersion):

The oil emulsion viscosity and oil film thickness are the limiting factors for this strategy. The predicted film thicknesses are >0.2-0.3 mm which is the estimated upper limit for effective use of water flushing. Water flushing should therefore not be a main response option for Yme but could be a supplementary method if there are areas on the sea surface with thin oil films e.g., metallic /rainbow appearance in very calm weather conditions.

Monitoring and remote sensing: Monitoring and remote sensing should always be used a support in a response operations for Yme.

2 Introduction

New oil types, from heavy crude oil to light crude oils and condensates, are continuously coming into production worldwide, as well as on the Norwegian continental shelf. Due to large variations in different crude oils' physical and chemical properties, their behaviour and fate may vary greatly if spilled at sea. For example, the "Braer" accident at the Shetlands (1993) and the "Sea Empress" accident in Wales (1996) have demonstrated how different the fate and behaviour of the crude oils can be when spilled on the sea surface. For that reason, obtaining comprehensive knowledge about the expected behaviour of spilled oil at sea is of great importance. Moreover, the "Deepwater Horizon" incident in the Gulf of Mexico (2010) clearly showed how the efficacy of the different response techniques changed as the oil weathered and emulsified on the sea surface over a time after the release. These past experiences and other incidents shape the knowledge base and the subsequent refinement of future operative strategies in terms of where, when, and how the mitigation methods should operate during a response operation. Appendix A describes the general physical and chemical properties and weathering processes of oil spilled on the sea surface.

According to the Norwegian Environment Agency (NEA) and the Petroleum Safety Authority Norway (Ptil) regulations for petroleum activities (Aktivitetsforskriften §59), the characterization of oils with respect to their weathering properties and fate in the marine environment should be performed for all oils coming into production. SINTEF Ocean has performed a standardized bench-scale and dispersibility testing on Yme crude oil at 5 and 13 °C, and a supplementary meso-scale flume testing at 13 °C. The obtained laboratory data have been used to predict the weathering properties of Yme crude oil at 5 and 15 °C, reflecting winter and summer seawater temperatures in the North Sea, by use of the SINTEF Oil Weathering Model (OWM). Such documentation gives an important basis for oil spill contingency planning and decision making during an oil spill operation. Information about the Yme field is given, below (*Figure 2-1*).

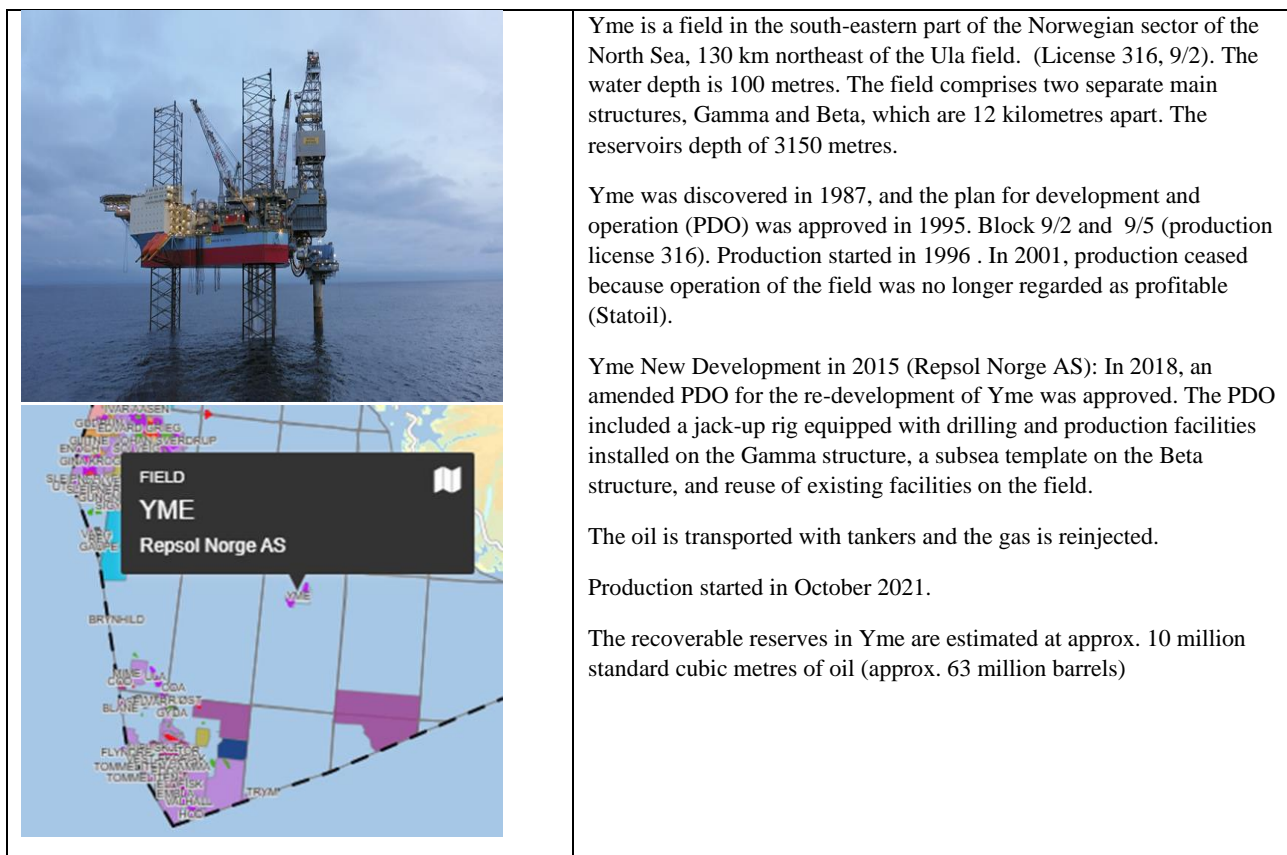

Figure 2-1: The Yme field in the North Sea. Photo: Repsol. <https://www.npd.no/en/facts/news/general-news/2021/yme-starts-up-again/>
<https://www.norskpetroleum.no/en/facts/field/yme>

3 Bench-scale laboratory testing

Description of the oil sample of Yme for testing and the experimental setup for the bench-scale and dispersibility methods are given in Appendix B. The physico-chemical parameters and weathering properties of Yme are compared with previous weathering studies of Ula, Oda, Bream, Rev and Blane in this report. The oils for comparison were selected in agreement with the client and are listed with some detail in Table 3-1.

Table 3-1: Oils compared with Yme in this report.

Oil name	SINTEF Id	SINTEF report no	Reference
Ula	1999-0002	STF66 F99076	Myrhaug, Daling, and Jensen, 1999
Oda	2019-4130	2019:01159	Sørheim et al., 2019
Bream	2010-0257	SINTEF A19404	Strøm and Leirvik, 2011
Rev*	2008-0470	SINTEF A12367	Strøm and Bakken, 2009
Blane	2008-0099	SINTEF A12212	Strøm, Johnsen, and Oltedal, 2009

*Condensate

3.1 Gas chromatographic (GC-FID) characterization

The hydrocarbon profile of Yme was analysed by use of gas chromatography (GC) coupled with Flame Ionization detector (FID). Figure 3-1 illustrates the GC-FID outputs (gas chromatograms) of the fresh oil of Yme and the corresponding evaporated residues at three different degrees of evaporative loss of volatiles with boiling points 150, 200 and 250°C+ (see Appendix B.2). The loss of low molecular weight (volatiles) compounds (shown towards the left of the chromatogram) at the three temperatures mimics that of natural weathering (evaporative loss at sea) corresponding to approximately 0.5-1-hour, 0.5-1 day and 0.5-1 week of weathering on the sea surface respectively.

The gas chromatograms show the *n*-alkanes as systematic narrow peaks. The first peaks in the chromatogram represent components with the lowest boiling points. Some of the more complex components, such as resins and naphthenes, are shown as a broad and poorly defined bump below the sharp peaks and are often described as the "Unresolved Complex Mixture" (UCM). Heavier compounds such as asphaltenes (> *n*C₄₀) are not possible to analyze with this technique.

Yme is a medium paraffinic crude oil with a main range of *n*-alkanes (paraffins) from *n*C₅ to *n*C₃₀ as shown in Figure 3-1. Figure 3-2 shows the GC-FID profile of fresh Yme in comparison with similar profiles for Ula, Oda, Bream, Rev and Blane. All the oils in comparison exhibit paraffinic features. Moreover, GC-FID is an important tool for oil characterization and for oil spill identification as an initial step. Common screening parameters used for identification, as well as for the degree of biodegradation, are the *n*C₁₇/Pristane and *n*C₁₈/Phytane ratios. Table 3-2 shows the ratios of Yme in comparison with Ula, Oda, Bream, Rev and Blane.

Table 3-2: *n*C₁₇/Pristane and *n*C₁₈/Phytane ratios.

Oil name	<i>n</i> C ₁₇ /Pristane	<i>n</i> C ₁₈ /Phytane
Yme	1.6	1.7
Ula	2.2	2.3
Oda	2.0	2.4
Bream	1.3	1.4
Rev	1.4	1.4
Blane	1.9	2.3

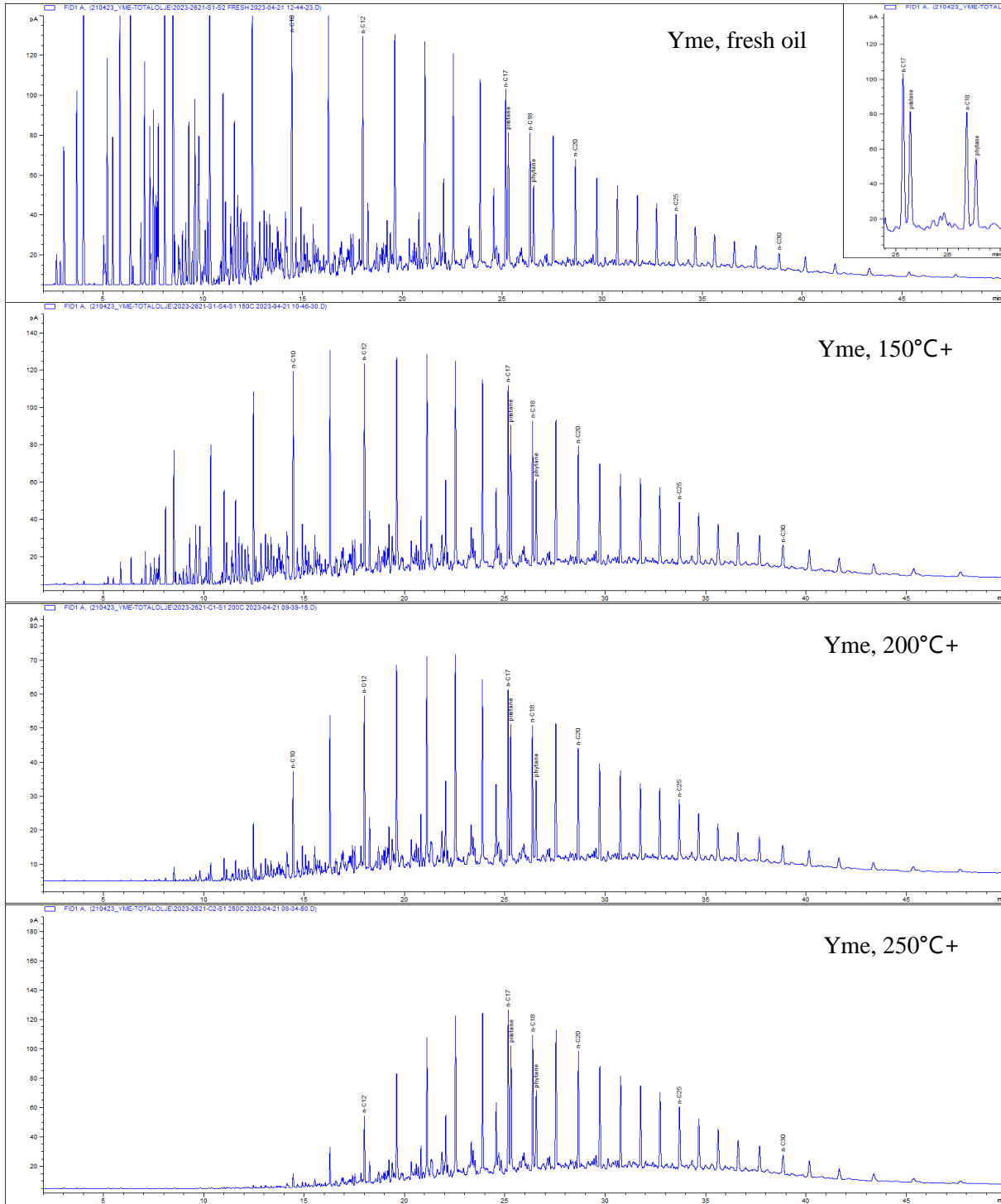

Figure 3-1: GC-FID chromatograms of fresh oil and evaporated residues of Yme.

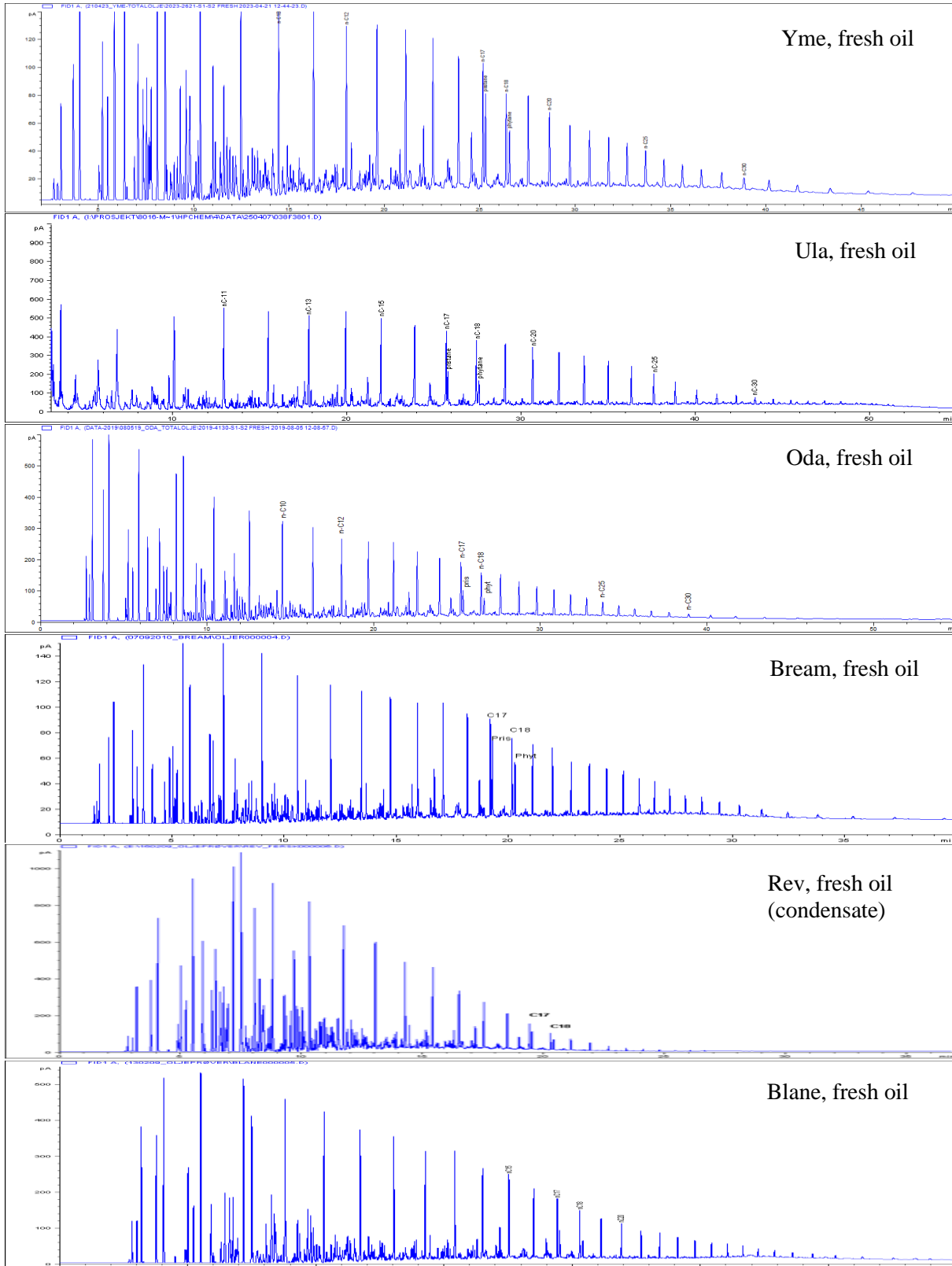

Figure 3-2: GC-FID chromatograms for fresh oils of Yme in comparison with Ula, Oda, Bream, Rev and Blane. The retention times may differ between the chromatograms due to different temperature programs (relative comparison).

3.2 Asphaltenes and wax content

The content of asphaltenes and wax of Yme in comparison with Ula, Oda, Bream, Rev and Blane are shown in Table 3-3. The presented oils exhibit different contents of asphaltenes and wax. Compared to the range presented, Yme has intermediate contents of both asphaltenes (0.54 wt.%) and wax (3.38 wt.%). Bream shows a significantly higher asphaltenic content (1.8 wt.%), while Rev (being a condensate) has as expected a low content of both asphaltenes (0.01 wt.%) and wax (0.6 wt.%).

Table 3-3: Asphaltene ("hard") and wax content of Yme in comparison with Ula, Oda, Bream, Rev and Blane.

Oil type	Residue	Asph ¹⁾ (wt. %)	Wax (wt. %)
Yme	Fresh	0.54	3.38
	150°C+	0.64	3.99
	200°C+	0.73	4.53
	250°C+	0.82	5.11
Ula	Fresh	0.42 ²⁾	5.77 ²⁾
	150°C+	0.52 ²⁾	7.06 ²⁾
	200°C+	0.59 ²⁾	8.11 ²⁾
	250°C+	0.67 ²⁾	9.19 ²⁾
Oda	Fresh	0.44	5.6
	150°C+	0.56	7.1
	200°C+	0.63	8.1
	250°C+	0.75	9.6
Bream	Fresh	1.8	4.3
	150°C+	2.0	4.7
	200°C+	2.2	5.2
	250°C+	2.4	5.7
Rev	Fresh	0.01	0.6
	150°C+	0.01	1.0
	200°C+	0.02	1.4
	250°C+	0.03	2.1
Blane	Fresh	0.3	5.3
	150°C+	0.4	6.5
	200°C+	0.4	7.5
	250°C+	0.5	8.8

1) *n*-heptane (nC₇) precipitation

2) Data from 1987-91

3.3 Physical properties of the fresh and weathered residues

The physical properties of Yme are shown in Table 3-4 in comparison with Ula, Oda, Bream, Rev and Blane. Fresh Yme crude oil has a medium density of 0.842 g/mL and is most comparable to Ula (0.832 g/mL) and Bream (0.857 g/mL).

The evaporative loss of Yme is 38 vol. % for the 250°C+ residue and is most like Ula (41 vol %). Correspondently, Rev condensate has the highest evaporative loss of 75 vol%, whilst Bream has the lowest evaporative loss of 27 vol. %, among these oils.

Yme expresses relatively high viscosities of the fresh oil and residues, and the viscosities are in the same range as measured for Oda and Bream. Among these oils, Bream expresses overall the highest viscosities, whilst Ula followed by Blane and the Rev condensate have significantly lower viscosities.

The pour point of fresh Yme is measured to +3 °C but increases significantly in the range of +24 to 30 °C with evaporation, which is typically for paraffinic oils with waxy components. The oils for comparison exhibit relatively high pour points of their residues, except for the Rev condensate that has low pour points according to the very low wax content.

Table 3-4: Physical properties of Yme in comparison with Ula, Oda, Bream, Rev and Blane.

Oil type	Residue	Evap. (vol. %)	Residue (wt. %)	Density (g/mL)	Flash point (°C)	Pour point (°C)	Visc. (mPa·s) 5°C (10 s ⁻¹)	Visc. (mPa·s) 13°C (10 s ⁻¹)	IFT (mN/m), init./5 min)
Yme	Fresh	0	100	0.842	-	3	309	124	28 / 17*
	150°C+	18	85	0.868	41	24	2020	390	29 / 17*
	200°C+	29	75	0.883	80	27	6314	1170	28 / 17*
	250°C+	38	66	0.894	109	30	13727	3894	30 / 19*
Ula	Fresh	0	100	0.832	-	-9	30	6	-
	150°C+	20	83	0.861	-	15	153	42	-
	200°C+	31	73	0.874	-	18	3501	168	-
	250°C+	41	63	0.886	-	21	4865	188	-
Oda	Fresh	0	100	0.820	-	-3	-	13	36
	150°C+	26	78	0.862	41	12	-	264	35
	200°C+	36	69	0.876	77	18	-	1565	34
	250°C+	46	58	0.890	117	24	-	6070	33
Bream	Fresh	0	100	0.857	-	18	2810	705	-
	150°C+	10	92	0.874	42	21	5620	1000	-
	200°C+	19	84	0.885	77	24	9205	2460	-
	250°C+	27	76	0.897	107	27	16640	5665	-
Rev	Fresh	0	100	0.779	-	-21	1	1	-
	150°C+	41	61	0.816	33	-6	6	2	-
	200°C+	61	42	0.834	67	3	33	5	-
	250°C+	75	27	0.850	99	9	94	13	-
Blane	Fresh	0	100	0.817	<-21	0	20	6	-
	150°C+	21	82	0.850	32	9	1030	140	-
	200°C+	33	71	0.865	75	18	2840	560	-
	250°C+	44	60	0.879	108	24	6980	1070	-

* Measured pendant drop after 5 min.

- No data

The True Boiling Point curves (TBP) of Yme in comparison with the boiling point curves of Ula, Oda, Bream, Rev and Blane are shown in Figure 3-3. Rev and Bream clearly show different evaporative properties compared to the other four oils, which show similar tendencies.

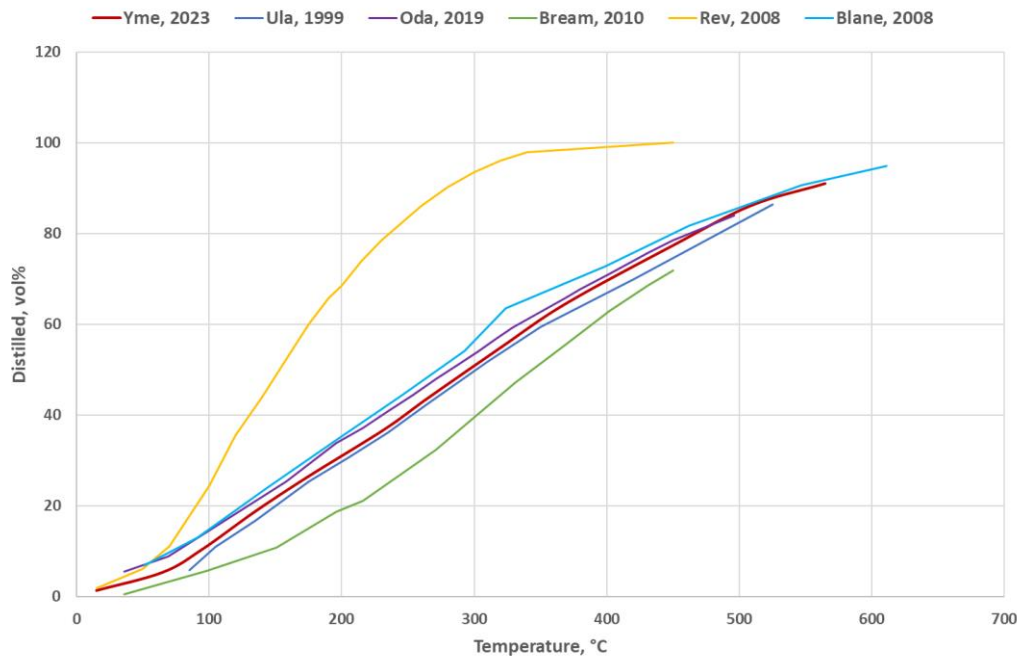

Figure 3-3: True boiling point curves of Yme in comparison with Ula, Oda, Bream, Rev and Blane.

3.4 Emulsifying properties

In general, oil-in water (o/w) emulsification is the mixing of seawater droplets into spilled oil at the sea surface (water-in-oil emulsion). The rotating cylinder method (Mackay and Zagroski, 1982) was used to study the emulsifying properties of Yme, and the procedure for maximum water uptake is described in Hokstad et al. 1993 (Appendix B).

3.4.1 Emulsification

Emulsification testing of Yme were conducted on the residues of 150°C+, 200°C+ and 250°C+ to produce data for stability, viscosity, maximum water uptake, kinetics of water uptake, and the effectiveness of the emulsion breaker application. Emulsions of the maximum water content after 24 hours rotation are shown in Figure 3-4 and Figure 3-5 at 5 and 13 °C, below.

The figures show from left to right four emulsions prepared from the residues of 150°C+, 200°C+ and 250°C+, respectively.

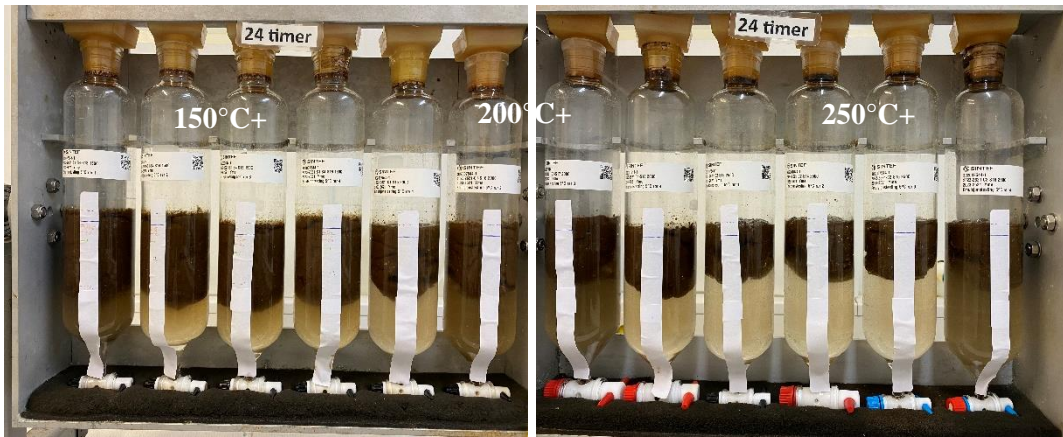

Figure 3-4: Rotating cylinders of water-in-oil (w/o) emulsions of Yme after 24 hours at 5 °C.



Figure 3-5: Rotating cylinders of water-in-oil (w/o) emulsions of Yme after 24 hours at 13 °C.

3.4.2 Kinetics of water uptake

The rate (kinetics) of water content in the water-in-oil (w/o) emulsions as a function of time is tabulated in Table 3-5 and Table 3-6 for testing at 5 and 13°C. The $t_{1/2}$ values are defined as the time (hours) it takes to incorporate half of the maximum water uptake (vol. %) in 24 hours (rotating time).

Table 3-5: Kinetics ($t_{1/2}$) for the emulsified residues of Yme at 5 °C.

Mixing time	150°C+ * (vol. % water)	200°C+ * (vol. % water)	250°C+ * (vol. % water)
Start	0	0	0
5 min	20	6	6
10 min	28	8	8
15 min	34	17	15
30 min	46	44	33
1 hour	60	69	50
2 hours	79	76	59
4 hours	85	79	63
6 hours	86	80	67
24 hours	85	79	72
$t_{1/2}$	0.41	0.47	0.65

* Depending on weather situation and release rate, the residues are corresponding to approximately 0.5-1-hour, 0.5-1 day and 0.5-1 week of weathering on the sea surface.

Table 3-6: Kinetics ($t_{1/2}$) for the emulsified residues of Yme at 13 °C.

Mixing time	150°C+ * (vol. % water)	200°C+ * (vol. % water)	250°C+ * (vol. % water)
Start	0	0	0
5 min	26	18	5
10 min	37	27	20
15 min	44	34	39
30 min	59	65	70
1 hour	82	84	78
2 hours	91**	84	78
4 hours	91**	84	79
6 hours	91**	84	79
24 hours	91**	84	79
$t_{1/2}$	0.26	0.26	0.25

* Depending on weather situation and release rate, the residues are corresponding to approximately 0.5-1-hour, 0.5-1 day and 0.5-1 week of weathering on the sea surface.

** 91 vol. % is due to supersaturation of emulsion and will likely not occur at sea.

3.4.3 Efficiency of emulsion breaker and stability of emulsions

Stability of emulsions

The emulsion stability was studied by quantifying the amount of volume fraction of water released from the emulsion after 24 hours settling time. Overall, Yme formed stable w/o-emulsions of the 150, 200 and 250°C+ residues at 5 and 13 °C, as shown in the first main row of and Table 3-7 and Table 3-8. The emulsions released only an insignificantly small amount of water after settling time, with stability ratios in the range of 0.94-1.00 at 5 and 0.90-0.99 at 13 °C. A stability ratio of 1.00 implies a totally stable emulsion.

Efficiency of emulsion breaker

In mechanical recovery operations, separating oil from water enables optimal use of available storage (i.e., facilities/tankers), and the efficiency of this separation can be enhanced by applying emulsion breakers. The effectiveness of the emulsion breaker Aerosol OT-SE surfactant was evaluated on different residues of emulsified Yme at 5 and 13 °C and are shown in Table 3-7 and Table 3-8. The choice of emulsion breaker was made in accordance with the client and NOFO.

At 5 °C, the results show that Yme forms stable emulsions for all residues that will retain most of the water content if left untreated. Use of emulsion breaker had a good effect on the separation of oil and water phase, and the effect was shown to be dosage dependent. In the laboratory, adding 2000 ppm (0.2 wt.%) of the emulsion breaker relative to the oil was most efficient (58-95 %) to break the emulsion compared with a lower concentration of 500 ppm, particularly for the 200 and 250°C+ emulsions (<50% effectiveness). Hence, for optimal separation at lower temperatures a high dosage of emulsion breaker is recommended for Yme where the effect of the emulsion breaker is affected by the degree of weathering. Emulsions made from the 250°C+ showed less response to the emulsion breaker compared to the 200°C+ emulsions, which again showed somewhat lower effectiveness than the 150°C+ emulsions.

Similar properties were also shown at 13°C for Yme. Untreated emulsions remained stable, while treated emulsions with emulsion breaker released water depending on dosage and degree of weathering. The effectiveness of emulsion breaker was found to be overall to be more efficient at 13°C than 5 °C. The effectiveness of adding 2000 ppm of the emulsion breaker showed a high effectiveness of 90-98 %, and similar 47-95% effectiveness with a lower concentration of 500 ppm (< 50 % efficient for the 250°C+ emulsion).

Table 3-7: Stability of emulsion and the effectiveness of emulsion breaker at 5 °C of Yme.

Residue Yme	Emulsion breaker	Water-in-oil emulsion (vol. %) at 13 °C		Stability ratio***	% Effect. (Released water)
		Reference*	24 hours settling **		
150°C+	None	85	84	0.94	6
200°C+	None	79	79	0.96	4
250°C+	None	72	72	1.00	0
150°C+	OT-SE 500 ppm	85	57	0.23	77
200°C+	OT-SE 500 ppm	79	67	0.54	46
250°C+	OT-SE 500 ppm	72	64	0.71	29
150°C+	OT-SE 2000 ppm	85	21	0.05	95
200°C+	OT-SE 2000 ppm	79	33	0.13	87
250°C+	OT-SE 2000 ppm	72	52	0.42	58

* Reference: w/o emulsion after 24 hours rotation

** : w/o-emulsion after 24 hours rotation and 24 hours settling.

*** Stability ratio of 0 implies a totally unstable emulsion after 24 hours settling; all the water is settled out for 24 hours settling. Stability ratio of 1 implies a totally stable emulsion.

Table 3-8: Stability of emulsion and the effectiveness of emulsion breaker at 13 °C of Yme.

Residue Yme	Emulsion breaker	Water-in-oil emulsion (vol. %) at 13 °C		Stability ratio***	% Effect. (Released water)
		Reference*	24 hours settling **		
150°C+	None	91	91	0.99	1
200°C+	None	84	83	0.90	10
250°C+	None	79	78	0.98	2
150°C+	OT-SE 500 ppm	91	19	0.02	98
200°C+	OT-SE 500 ppm	84	66	0.37	63
250°C+	OT-SE 500 ppm	79	66	0.53	47
150°C+	OT-SE 2000 ppm	91	17	0.02	98
200°C+	OT-SE 2000 ppm	84	21	0.05	95
250°C+	OT-SE 2000 ppm	79	27	0.10	90

* Reference: w/o emulsion after 24 hours rotation

** : w/o-emulsion after 24 hours rotation and 24 hours settling.

*** Stability ratio of 0 implies a totally unstable emulsion after 24 hours settling; all the water is settled out for 24 hours settling. Stability ratio of 1 implies a totally stable emulsion.

3.5 Emulsion viscosities and yield stress

Viscosities of emulsified residues of Yme at 5 and 13 °C are given in Table 3-9 and Table 3-10 (including fresh oil and waterfree residues). The emulsions behave as *non-Newtonian* fluids due to the increasing degree of weathering (evaporation and water uptake), with higher viscosities at a lower shear rate (10 s^{-1}) compared to the viscosities measured at higher shear rate (100 s^{-1}). This decrease in viscosity with increasing shear rate is due to the shear thinning property of emulsion with increased mechanical force.

Yield stress is defined as the force that must be overcome so that an oil can spread / flow like a liquid on the sea (also known as the flow limit). This force is called the fluids "yield stress" or flow limit and is given the

unit Pascal (Pa). Many crude oils (particularly weathered residues and emulsions) are so-called Bingham-plastic fluids at sea temperature. This means that applied force must be exerted to the fluid to make it flow and spread and is mainly pronounced for non-Newtonian oils where the viscosities vary with the shear rate. Results are given in

Table 3-9 and Table 3-10 at and 13 °C, respectively. Yme has relatively high yield stress of the 200 and 250°C+ residues / emulsions, and the oil is expected have reduced flowability and spreading properties after some days weathering at sea.

Table 3-9: Viscosities waterfree residues and emulsions of Yme at 5 °C.

Yme	Water content (vol. %)	Viscosity 5 °C (mPa·s) 10 s ⁻¹	Viscosity 5 °C (mPa·s) 100 s ⁻¹	Yield stress Pa
Fresh	0	309	89	0.34
150°C+	0	2020	304	2.89
200°C+	0	6314	803	13.7
250°C+	0	13727	1634	40.8
150°C+	50	1069	454	1.22
200°C+	50	2401	666	2.89
250°C+	50	13482	3465	40.1
150°C+	75	3185	928	2.8
200°C+	75	8899	2410	23.7
250°C+	75	18976	1431	33.9
150°C+	86	6646	1179	6.3
200°C+	79	7770	2039	25.6
250°C+	73	26960	566	114

Table 3-10: Viscosities waterfree residues and emulsions of Yme at 13 °C.

Yme	Water content (vol. %)	Viscosity 13 °C (mPa·s) 10 s ⁻¹	Viscosity 13 °C (mPa·s) 100 s ⁻¹	Yield stress Pa
Fresh	0	124	47	-
150°C+	0	390	118	0.51
200°C+	0	1170	288	1.19
250°C+	0	3894	577	7.21
150°C+	50	874	336	0.79
200°C+	50	1484	563	0.86
250°C+	50	4910	1072	3.69
150°C+	75	1766	546	1.05
200°C+	75	4507	1198	3.62
250°C+	75	9975	2358	5.13
150°C+	91	2412	480	0.78
200°C+	85	9199	1261	53.6
250°C+	79	13405	1056	36.2

3.6 Chemical dispersibility

The dispersibility testing of Yme included:

- Screening of dispersant effectiveness.
- Dosage testing of a relevant dispersant.
- Systematic testing on weathered /emulsified samples as a basis to predict the time-window for effective application of dispersant.

3.6.1 Screening testing of dispersants

The screening testing was performed using the low-energy IFP test (Institute Français du Pétrole), reflecting non-breaking waves (<5 m/s wind speed), in combination with the high-energy MNS test (Mackay-Nadeau-Szeto), reflecting breaking waves conditions (>5 m/s wind speeds). Dispersants tested were Dasic Slickgone NS, Corexit 9500A, Finasol OSR-52, and Gamlen OD 4000. The screening testing was performed at 13 °C using the 200°C+ residue emulsified with 50 vol. % seawater. The results are presented in Table 3-11.

The screening revealed significant variations in the effectiveness between tested dispersants. Dasic Slickgone NS was found to give the highest effectiveness on the tested emulsion with the low energy IFP-test, followed by Corexit 9500A and Finasol OSR 52. Gamlen OD 4000 was found poorly efficiency on the test-emulsion.

Table 3-11: Screening testing on Yme using the IFP-test and MNS-test at standard temperature of 13 °C.

Dispersant (DOR/DER** =1:25)	Efficiency dispersant (200°C+ /50 vol. % emulsion)* IFP	Efficiency dispersant (200°C+ /50 vol. % emulsion)* MNS
Dasic NS	50	100
Corexit 9500A	25	100
Finasol OSR 52	18	n.a.
Gamlen OD 4000	6	n.a.

* Emulsion viscosity: 1484 mPa·s (10s⁻¹) ** DOR=Dispersant to oil ratio /DER=Dispersant to emulsion ratio.
n.a: not analyzed.

Figure 3-6 shows example from the IFP- test use of Dasic Slickgone NS and Corexit 9500A. For the high-energy MNS test, Dasic Slickgone NS visually seemed to promote smaller oil droplets than with use of Corexit 9500A, as shown in Figure 3-7.



Figure 3-6: Example IFP-test on 200°C+ 50% emulsion, DOR/DER 1:25 of Yme. The two samples on the left are with Dasic Slickgone NS, and the one to the right is with Corexit 9500A.

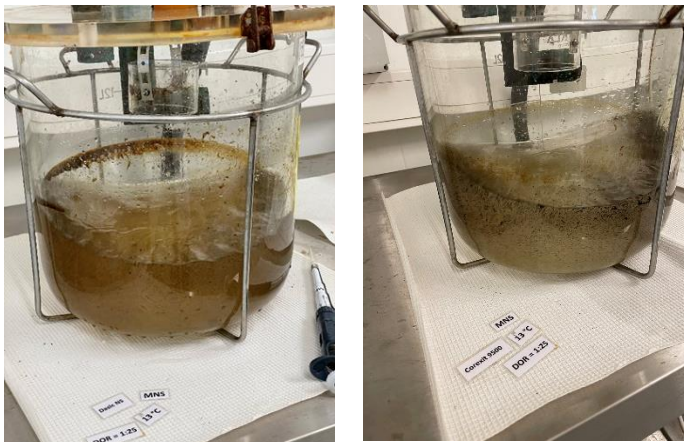

Figure 3-7: Example MNS high energy test on 200°C+ 50% emulsion, DOR/DER 1:25 of Yme. Left: Dasic Slickgone NS. Right: Corexit 9500A.

3.6.2 Dosage testing

The dosage test helps to identify optimal design conditions for dispersant use and was performed with Dispersant-to-Oil Ratios (DOR) of 1:25, 1:50, 1:100 and 1:200, and with no dispersant added. Dosage testing at 13 °C was performed using Dasic Slickgone NS on Yme emulsion (200°C+ / 50 vol. %). Dasic Slickgone NS is the main dispersant agent in NOFO's stockpile today.

Results from the dosage testing are presented in Table 3-12. The IFP-results showed a clear dosage dependent effectiveness, decreasing effectiveness with lower DOR/DER. The DOR/DER 1:25 showed the highest effect of 50% and was reduced to 32%, and 18% with DOR/DER 1:50 and 1:100, respectively, and showed almost no effect (8%) with DOR/DER 1:200. The MNS test gave high dispersion effectiveness for alle the dosage tested, but dosage of 1:25 and 1:50 clearly produced smaller oil droplets compared to the lower dosages of 1:100 and 1:200. Typically, lower dispersibility cause formation of larger oil droplet. For a test with poor dispersibility, large droplets may be formed and entrained in the sample, falsely skewing the results towards a higher effectiveness. No effect was observed with no dispersant added to the emulsion of Yme.

Table 3-12: Dosage testing on 200°C+/50% emulsion of Yme at 13 °C.

Dispersant (dispersant-to-emulsion ratio)	% Effectiveness 200°C+/ 50%* IFP	% Effectiveness 200°C+/ 50%* MNS
Dasic NS (1:25)	50	100
Dasic NS (1:50)	32	100
Dasic NS (1:100)	18	88
Dasic NS (1:200)	9	100**
No dispersant	n.a.	<5%

* Emulsion viscosity: 1246-1484 mPa·s (10s⁻¹) ** Entrainment of oil large oil droplets
n.a: not analyzed.

3.6.3 Systematic dispersant testing and dispersibility limits

A dispersant-oil-dosage ratio of 1:25 (4 wt.%) is commonly used as the standard procedure to establish the time window for dispersant application. The results from the systematic dispersant testing at 5 and 13 °C are shown in Table 3-13 and Table 3-14. Dispersibility limits are shown in Figure 3-8 and summarised in Table 3-15.

Table 3-13: Systematic testing and effectiveness of Dasic Slickgone NS on Yme at 5°C.

Yme	Water content (vol. %)	Viscosity 5 °C (mPa·s) 10 s ⁻¹	Effectiveness (%) IFP	Effectiveness (%) MNS
150°C+	0	2020	5	33
200°C+	0	6314	<5	n.a.
250°C+	0	13727	n.a.	n.a.
150°C+	50	1069	36	100
200°C+	50	2401	<5	37
250°C+	50	13482	n.a.	6.0
150°C+	75	3185	6	26
200°C+	75	8899	<5	<5
250°C+	75	18976	n.a.	n.a.
150°C+	86	6646	<5	14
200°C+	79	7770	n.a.	n.a.
250°C+	7	26960	n.a.	n.a.

n.a.: Not analyzed.

Table 3-14: Systematic testing and effectiveness of Dasic Slickgone NS on Yme at 13 °C.

Yme	Water content (vol. %)	Viscosity 13 °C (mPa·s) 10 s ⁻¹	Effectiveness (%) IFP	Effectiveness (%) MNS
150°C+	0	390	43	94
200°C+	0	1170	2	100
250°C+	0	3894	<5	11.8
150°C+	50	874	57	100
200°C+	50	1484	50	100
250°C+	50	4910	3	31.9
150°C+	75	1766	54	68
200°C+	75	4507	<5	4.3
250°C+	75	9975	<5	8.1
150°C+	91	2412	20	<5
200°C+	85	9199	<5	n.a.
250°C+	79	13405	n.a.	n.a.

n.a.: Not analyzed.

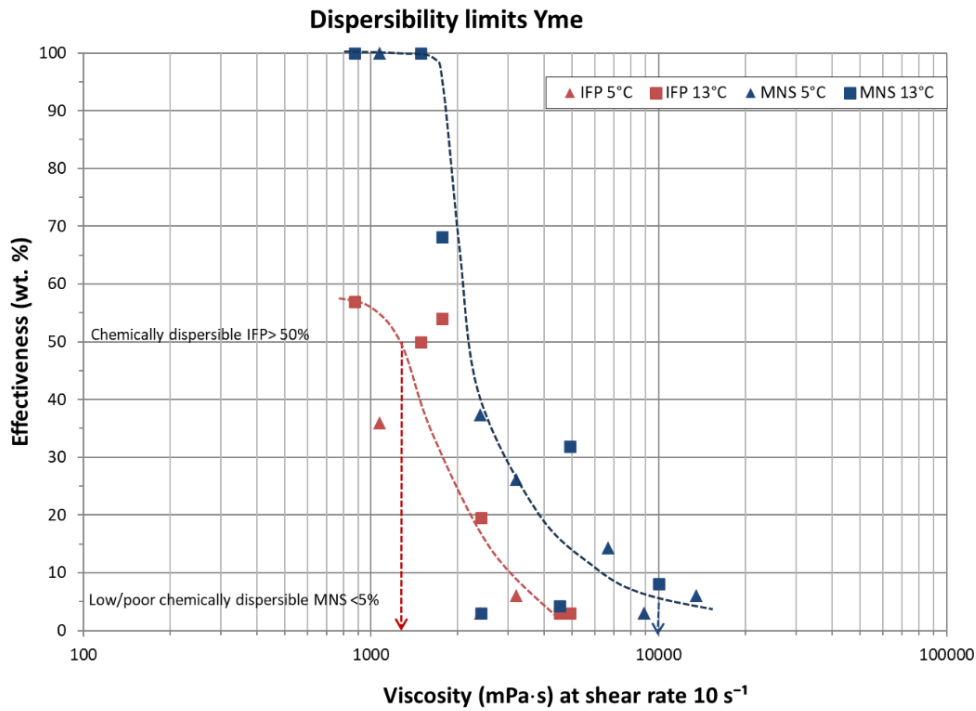

Figure 3-8: Dispersant effectiveness limits of Yme.

Yme was estimated to be chemically dispersible for viscosities lower than 1500 mPa·s (IFP-test) and to be poorly/not chemically dispersible for viscosities above 10000 mPa·s (based on the high energy MNS-test, reflecting breaking waves conditions, >5 m/s wind speeds), Table 3-15. Yme is expected to be reduced dispersible with viscosities between 1500-10000 mPa·s but may require additional energy and /or higher dispersant dosage or multiple applications to optimise effective dispersion.

Table 3-15: Estimated viscosity limits for Yme for use of dispersant and definition of time window.

Dispersibility	Criteria for effectiveness (wt. %)	Dispersibility limits based on emulsion viscosity (mPa·s)
Good chemically dispersible	IPF >50%	1500
Not/poor chemically dispersible	MNS < 5 %	10000

4 Meso-scale flume testing

The weathering behaviour of Yme was studied in a meso-scale flume basin. A description of the meso-scale flume is given in Appendix B.3. This chapter provides an overview of the results from the flume testing, including the weathering properties, estimated mass balances and visual observations of the Yme crude oil. The results obtained give valuable operational information about the oil's behaviour. The weathering behaviour of Yme in the flume basin is a supplement to the small-scale laboratory testing (Chapter 3).

A total of 8.2 litres of the fresh crude oil was applied carefully and evenly onto the surface seawater using a watering can. The seawater and air-temperature for this experiment was 13 °C (± 2 °C) due to sequence of the climate system. Setpoint wave: 34 (18 cm). After application of the crude oil onto the seawater, the wind and wave energy were switched on. Artificial sunlight using a solar simulator was turned on after 30 minutes simulating photo-oxidation. Samples of the water phase at 0.5m depth and surface oil/emulsion were taken during the experiments. The oil was weathered for 72 hours (3 days) in the flume before in-situ application of dispersant (Dasic Slickgone NS) on the surface oil.

The experimental results obtained for Yme in the meso-scale laboratory tests are presented below. In Table 4-1 the test data are given along with various measurements done during the tests.

Table 4-1: Results from the meso-scale weathering experiment of Yme at 13 °C.

Sample no.	Time (hours)	Water content (vol. %)	Evaporative loss (wt. %)	Viscosity (mPa·s), 10 s ⁻¹	Oil in water ppm*	Oil-in-water, wt. % of original amount
1	0.5	65	16	302	43	3
2	1	71	18	639	n.a	n.a
3	2	77	22	1614	n.a	n.a
4	4	78	24	2475	n.a	n.a
5	6	72	25	3007	n.a	n.a
6	24	76	31	3620	n.a	n.a
7	48	70	33	4110	n.a	n.a
8	72	64	35	4804	29	2
1st application of dispersant: 69.6 g Dasic NS (DOR = 2.1 wt. %)						
30 min. disp 1	-	-	-	3974	98	6
2nd application of dispersant: 73.4 g Dasic NS (DOR= 2.2 wt. %)						
30 min. disp 2	-	-	-	4119	395	24
3rd application of dispersant: 65.5 g Dasic NS (DOR= 2.0 wt. %)						
30 min. disp 3	-	-	-	-	412	24
60 min. disp 3	-	-	-	-	327	19

- No measured data /n.a.: not analyzed.

* ppm = parts per million

The oil weathering from the meso-scale flume basin (maximum water uptake, evaporative loss, and emulsion viscosity) were compared with weathering predictions using the SINTEF Oil Weathering Model (OWM) with input data from the small-scale study at 13 °C. More information about the OWM is described in chapter 5. The following comparisons of test results from the meso-scale and predicted behaviour of Yme are based on predictions from both 5 and 13 °C laboratory testing. Data from lab-analyses performed at 5 °C are the basis for predictions at 5 °C, while laboratory data from testing at 13°C are the basis for predictions at 15 °C.

4.1 Evaporation

Figure 4-1 shows the estimated evaporative loss in the meso-scale testing compared to the predicted evaporation at both winter and summer temperatures. Since the meso-scale flume testing was performed at 13 °C, the predictions for summer temperature (15 °C) are most appropriately used for comparison.

The predicted evaporative loss shows a good alignment with the measured evaporation from the flume test.

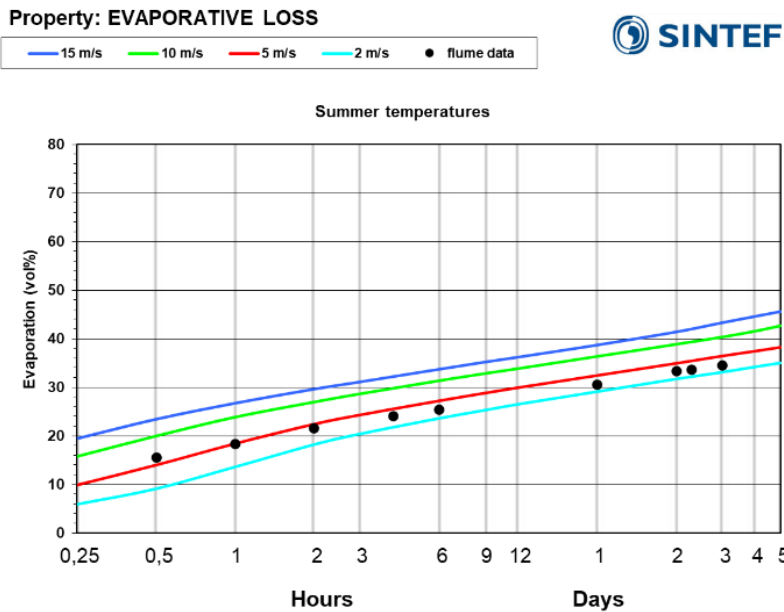

Figure 4-1: Predicted evaporative loss for Yme and results from meso-scale laboratory testing. The dots represent the experimental data from the meso-scale flume testing at 13 °C.

4.2 Water uptake

Figure 4-2 below shows the water uptake of the emulsion in the meso-scale testing compared to predicted values. The obtained flume data show a more rapid water uptake than the predicted water content. The higher water uptake within the first hours in the meso-scale flume can be explained by formation of unstable emulsions in with large water droplets during the first hours of weathering, and this phenomenon has also been observed for other paraffinic crude oils from flume experiments, as well. Overall, the results are considered as a good match.

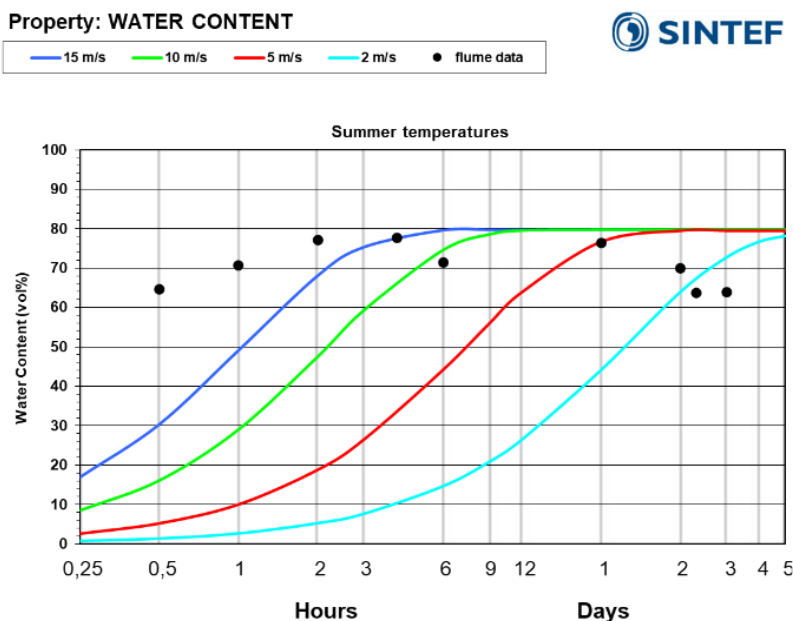

Figure 4-2: Predicted water uptake for Yme and results from meso-scale laboratory testing. The dots represent the experimental data from the meso-scale flume testing at 13 °C.

4.3 Emulsion viscosity

The predicted emulsion corresponds well to the measured flume data for the first 24 hours. Between 48-72 hours, the emulsion viscosities from the flume test are in the lower range of the predicted viscosities. This reflects the lower water uptake seen for the same flume samples compared to the predictions (Figure 3-11). The predictions may provide a more conservative view of the behaviour at sea of Yme.

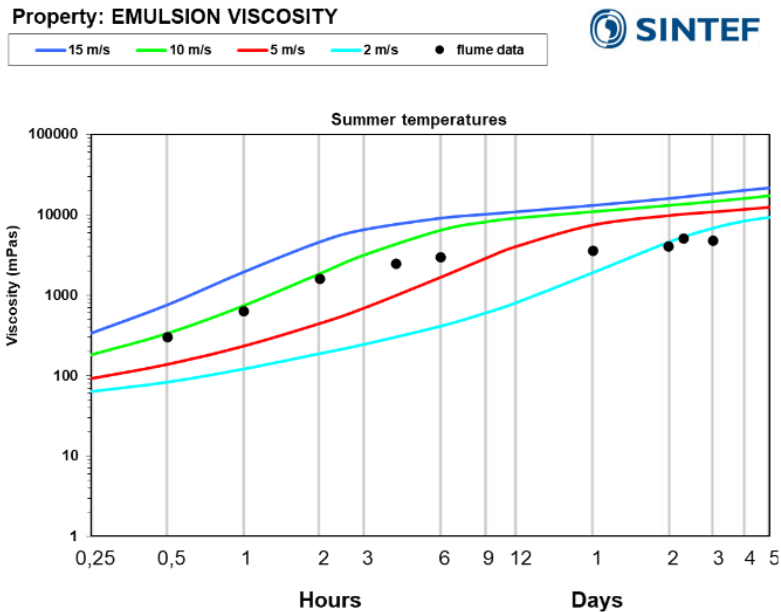

Figure 4-3: Predicted emulsion viscosity for Yme compared with results from the meso-scale laboratory testing. The dots represent the experimental data from the meso-scale flume testing at 13 °C.

4.4 Mass balance

The main elements in the mass balance for a crude oil spilled at sea are evaporative loss, the amount of oil on the surface, and the amount of oil dispersed. To conduct a mass balance, all oil must be accounted for. Therefore, in addition to the main elements, it was also necessary to consider each individual oil sample removed from the flume, the subsequent reduction in water volume, and the amount of oil absorbed to the flume wall.

The amount of oil evaporated, oil on surface, naturally dispersed/entrained and sampled oil was calculated, and the oil adsorbed to the flume walls was estimated by weight. Table 4-2 shows values for the mass balance of Yme during weathering in flume experiment after 24 hours, and Figure 4-4 show the mass balance for the first 72 hours.

Table 4-2: Mass balance for Yme during the meso-scale laboratory tests at 5 °C and 13 °C. Example after 24 hours of weathering time in the flume.

Mass balance (% of initial oil)	13 °C
Evaporated	31
Oil on water surface	55
Dispersed oil	3
Sampled amount of oil	6
Oil absorbed to the flume walls	5

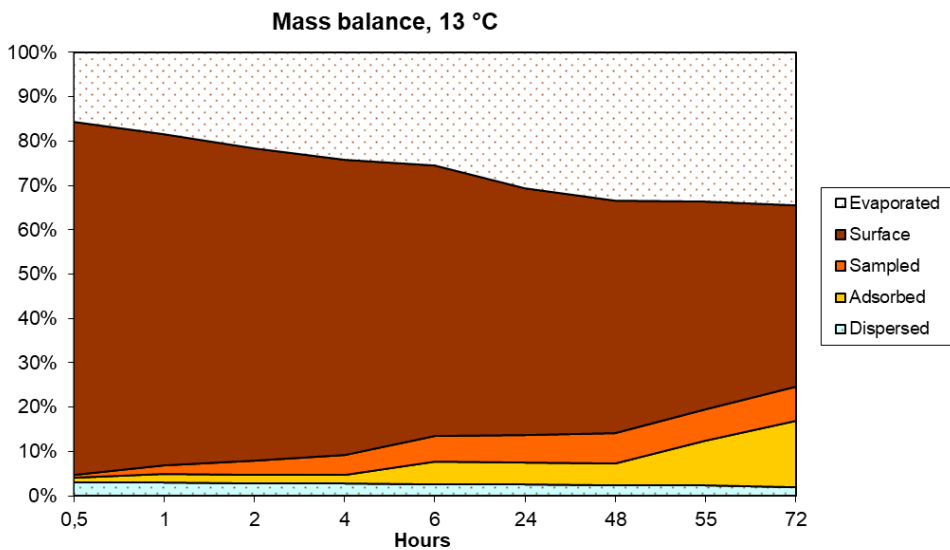

Figure 4-4: Mass balance of Yme in the 13 °C meso-scale laboratory test before the application of dispersant.

4.5 In-situ chemical dispersion

After 72 hours of weathering, the chemical dispersant Dasic NS was applied by spraying it on the water-in-oil emulsion (in situ application). The dosage ratios are given Table 4-3 below.

Table 4-3: Dispersant dosage rates used in Yme meso-scale experiments (in situ application) for Yme at 13 °C.

Dispersant application (#)	Dasic NS application (g)	Dispersant (wt. %)	Dispersant to oil ratio (DOR)	Dispersant to Emulsion Ratio (DER), wt. %
1	69.6	2.1	1:48	0.7
2	73.4	2.2	1:46	0.8
3	65.5	2.0	1:51	0.7
Cumulative	208.5	6.2	1:16*	2.2

* Dispersant-to-emulsion Ratio (DER) 1:45

The efficiencies of dispersion (Figure 4-5) are given as percentage (%) of the available oil after 72 hours of weathering (oil sample taken before application of dispersant), at 13 °C. Note, this differs from the mass balances (Figure 4-4) that show efficiency in percentage of originally applied amount of oil. Here we show that the percentage of available oil dispersed or entrained oil in the water phase increase from about 5-15% from the first round to 60% after the second round of dispersant application. The efficiency of dispersant decreased after the third round due to re-emulsification of the remaining surface oil.

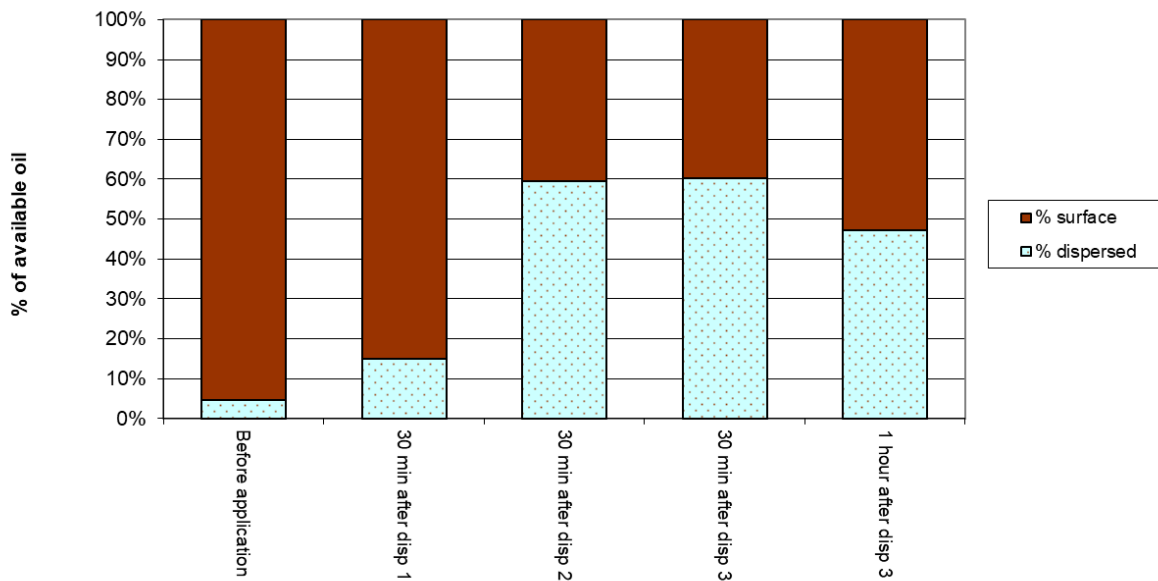

Figure 4-5: Mass balance of Yme after application of Dasic Slickgone NS as percentage of available surface oil at 13 °C. Surface oil vs. dispersed oil during and after dispersant treatments

4.6 Observations from the flume testing

A selection of images taken during the meso-scale experiments at 13 °C of Yme are presented below. The apparent difference in colour among the pictures is due to the changing colour of the oil as evaporation and emulsification takes place.

The applied fresh oil was immediately spread out across the water surface of the flume. Some boiling and bubbling were observed in the initial oil slick. Short time after application, the oil was quickly entrained into the water phase, consisting of mainly larger oil droplets that was rapidly resurfaced. The emulsion of Yme was highly unstable during the first hours, but during the 3 days experiment the oil emulsified to a thick, homogeneous, and light brownish emulsion. The emulsion appears to be stable by time.

After 30 minutes the oil reached a water uptake of 65%, and 16% of the lightest compounds had evaporated. The emulsion viscosity was 300 mPa.s (shear $10s^{-1}$, 13 °C). At this point, the sunlamp was switch on.

After 60 minutes. Some structure started to appear on the emulsion surface. Pockets of water have started to appear on the surface of the emulsion. Large droplets of oil were entrained into the water phase by waves – these were easily resurfaced. Water uptake: 71 %, evaporation: 18% and the viscosity: 640 mPa.s

After 2-6 hours, emulsion appeared more homogeneous, viscous, and stable. Larger pockets of water were observed in the emulsion. Fewer droplets of oil were observed in the water column. Water uptake: 72%, evaporation 25% and the viscosity: 3010 mPa.s.

After 24 hours, the emulsions appeared even more homogeneous, viscous, and stable. but still has a slightly grainy texture with particles of lighter brown colour scattered throughout the emulsion. Pockets of encapsulated seawater were observed in the emulsion surface. No dispersed oil was visually observed in the water phase. Water uptake: 76 %, evaporation: 31% and the viscosity: 3620 mPa.s (shear 10, 13 °C)

After 72 hours. Thick brown emulsion. the water content had decreased to 64%, with an evaporation of 36%. The viscosity of the emulsion at 72 hours was 4800 mPa.s.

Figure 4-6 shows an overview of pictures (time laps) from the weathering of Yme after 30 min, 4 hours, 6 hours, 48 hours and 72 hours, respectively.

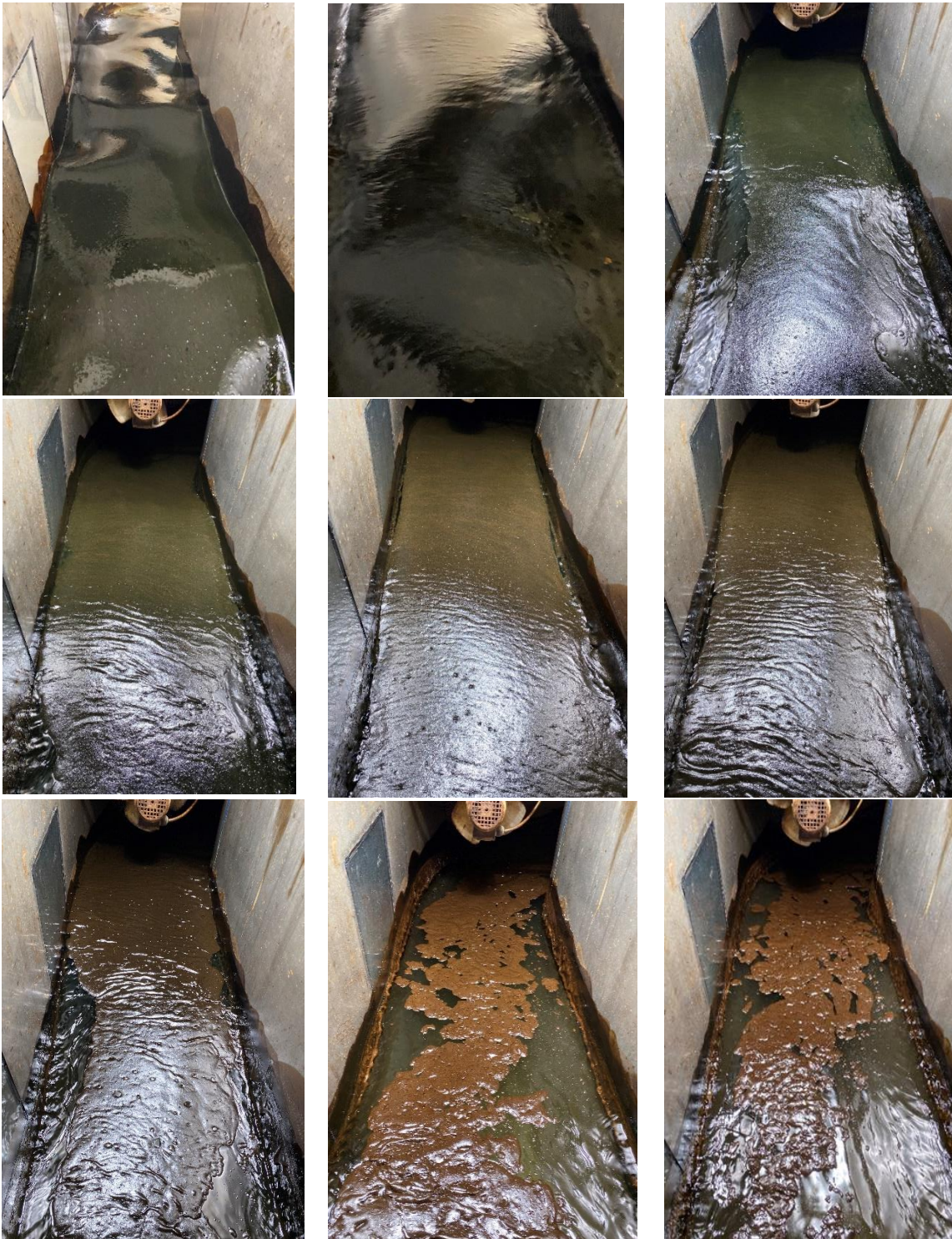

Figure 4-6 Weathering of Yme from top left to bottom right: $t = 0\text{min}$, 30min , 1 hour, 2 hours, 4 hours, 6 hours, 24 hours, 48 hours and 72 hours. For the first 2 photos (0 to 30 min) the sun lamp is not turned on and slightly effects the colour of the oil in the pictures.

Dispersant application after 72 hours weathering. Dasic Slickgone NS was applied as an aerosol by using a Wagner sprayer on the remaining emulsion (in-situ application). About 3.5 litres of the total volume of oil (8.2 litres) was available for chemical dispersion and corresponds to about 9.3 litres of emulsion. The dispersant was applied in three rounds (replicates) on the surface oil/emulsion giving a cumulative dispersant-to-oil ratio (DOR) of 1:16, reflecting a dosage-to-emulsion ratio (DER) of 1:45.

The dispersant slightly reduced the emulsion viscosity from 4804 mPa.s (before treatment) to 3974 - 4119 mPa.s after treatment. The water phase turned into a light brown colour that indicated formation of smaller oil droplets in μm -size.

After the first round of dispersant application the oil viscosity decreased, and the emulsion flattened. The oil is only partially dispersed. Approximately 16 % of the available surface oil was dispersed into the water column.

After the second round of dispersant application the emulsion again flattened, and a significant amount of oil was dispersed into the water column. Approximately 62 % of the originally available surface oil was dispersed into the water column. Some thicker oil lumps were observed on the surface, these are believed to be oil that was adhered to the flume walls prior to dispersant application. Some re-emulsification was observed 30 minutes after dispersant application.

After the third round of dispersant application the emulsion flattened again. The oil is partially dispersed. Lumps of oil are probably oil originally adhered from the flume walls remain on the surface. Approximately 63 % of the available surface oil was dispersed into the water column. Some re-emulsification was observed 30 minutes after dispersant application, resulting in a decrease of dispersed oil, to 51 % of available oil, one hour after dispersant application.

Figure 4-7 to Figure 4-10 show images of the surface emulsion after treatment of dispersants.



Figure 4-7: Emulsion 30 minutes after first application of Dasic Slickgone NS.



Figure 4-8: Emulsion 30 minutes after the second application of Dasic Slickgone NS.



Figure 4-9: Emulsion 30 minutes after the third application of Dasic Slickgone NS.



Figure 4-10: Emulsion 60 minutes after the third application of Dasic Slickgone NS.

4.7 Remarks from the meso-scale flume testing of Yme

Overall, the meso-scale flume experiment of Yme showed consistent weathering data with the bench-scale study and the OWM predictions.

In the flume the dispersed or entrained oil droplets in mm-sizes were shown to be easily re-resurfaced. A rapid water uptake was observed within a short time of weathering, 65 vol. % after 30 minutes producing unstable emulsion. As more of the lighter components in the oil evaporated the emulsion became more stable with increasing viscosities. The flume testing also indicated that the emulsified oil would require repetitive application rounds of dispersant (cumulative DOR 1:16) to break up the "slick" into patches and disperse or entrain the oil droplets into the water phase (~62% of available oil). The dispersant application also showed that the dispersant needed time, in combination of waves to disperse the stable emulsions of Yme. Moreover, the emulsion of Yme showed to be reduced dispersible after 72 hours with a viscosity of 4804 mPa.s that is in accordance with the bench-scale dispersibility study. However, it is expected that Yme could be good dispersible the first hours for viscosities lower than 1500 mPa.s (estimated from the bench-scale study).

5 Predictions with SINTEF Oil Weathering Model (OWM)

5.1 Description of SINTEF OWM

A systematic stepwise laboratory procedure developed at SINTEF (Daling et al., 1990) was used to isolate and map the various weathering processes that take place when oil is spilled on the sea surface. Laboratory study of Yme was conducted at 5 and 13 °C, and the analytical data were further used as input to the SINTEF Oil Weathering Model (OWM). The experimental design for the study is described in Appendix B. The input data of Yme to the SINTEF OWM are given in Appendix C.

The SINTEF OWM relates oil properties to a chosen set of conditions (oil/emulsion film thickness, wind speeds and sea temperature) and predicts the change rate of the oil's properties on the sea surface with time. The SINTEF OWM is schematically shown in Figure 5-1. The predictions obtained from the SINTEF OWM are useful tools in the oil spill contingency planning related to the expected behaviour of oil on the sea surface, and to evaluate the time window for operational response strategies in a spill operation. In this report, the presented predictions span a period from 15 minutes to 5 days after an oil spill has occurred. The SINTEF OWM is described in more detail in Johansen (1991), and in the user's guide for the model.

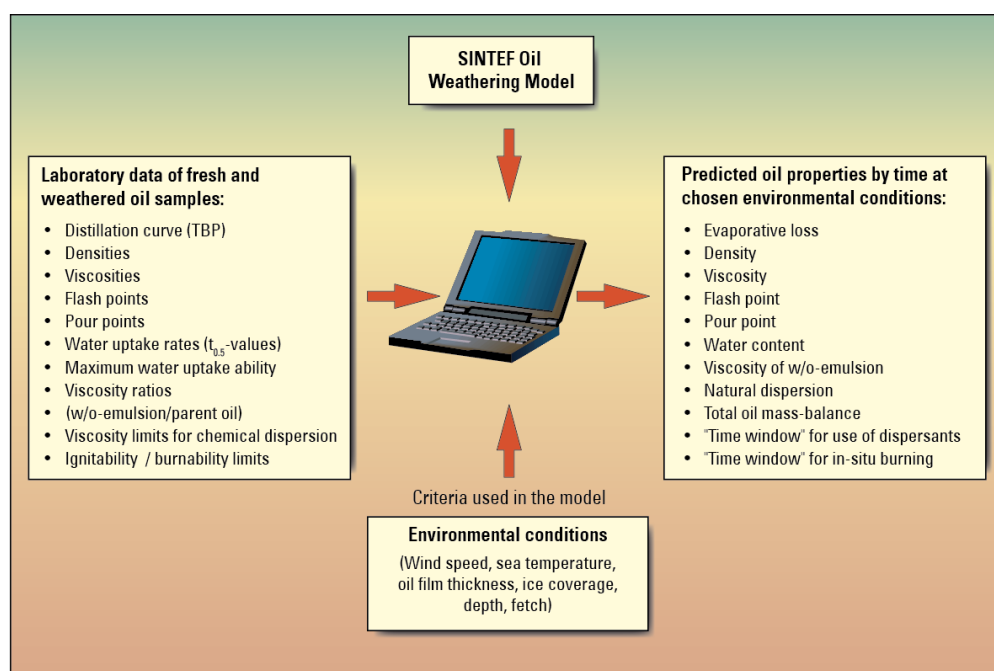

Figure 5-1: Schematic input data to the SINTEF OWM and the predicted output oil properties.

Oil film thickness

Oils in OWM are categorized as condensate (non-emulsifying oil), low emulsifying oil/condensate, emulsifying oil, heavy bunker fuel or refined distillate. The categorization is based on the experimental results obtained in the laboratory. The terminal film thicknesses vary among these categories based on experimental (field) experience. Yme is categorized as an emulsifying oil in OWM with 1 mm terminal film thickness.

Seawater temperature

The prevailing weather conditions greatly influence the weathering rate of oil on the sea surface. Due to the location of the oil field, the seawater temperatures chosen for Yme predictions were 5 and 15 °C, reflecting typically winter and summer conditions.

Wind speed

The relationship between the wind speed and significant wave heights used in the prediction charts obtained from the SINTEF OWM are shown in Table 5-1.

Table 5-1: Relationship between wind speed and significant wave height used in the SINTEF OWM.

Wind speed [m/s]	Beaufort wind	Wind type	Wave height [m]
2	2	Light breeze	0.1 - 0.3
5	3	Gentle to moderate breeze	0.5 - 0.8
10	5	Fresh breeze	1.5 - 2.5
15	6 – 7	Strong breeze	3- 4

5.2 Predictions of weathering properties of Yme

A standard surface release was used as a spill scenario. The scenario chosen is not oil field specific but selected to give predictions of the expected weathering properties of the oil based on the experimental data and specified terminal oil film thickness. A standardized scenario will also more easily compare results of weathering properties with other oils.

Input to SINTEF OWM

Oil type:	Crude oil
Geographical area:	North Sea
Terminal oil film thickness:	1 mm
Release rate:	1.33 metric tonnes per min. in 15 min, a total of 20 metric tonnes (80 m ³ /hour or 1900 m ³ /day)
Seawater temperatures:	5 and 15 °C
Wind speeds:	2 m/s, 5 m/s, 10 m/s and 15 m/s

Predicted properties:

- Evaporative loss
- Viscosity
- Flash point
- Pour point
- Mass balance

The predictions are based on 5 days weathering independently if there is not predicted any remaining oil within shorter time. The predictions are shown to indicate the weathering properties in cases there are patches or oil left on the surface up to 5 days.

How to use the prediction charts: an example

If the oil has drifted on the sea surface, the following prediction charts could be used to determine the weathering properties of the oil/emulsion.

Table 5-2 and Table 5-3 gives an example of predicted weathering properties for Yme.

Table 5-2: Example of weathering properties of Yme obtained from the OWM predictions after 12 hours of weathering at 2, 5 and 10 m/s at 5 °C.

Weathering properties	12 hours 5 °C 2 m/s	12 hours 5 °C 5 m/s	12 hours 5 °C 10 m/s	12 hours 5 °C 15 m/s
Evaporation, wt. %	24	27	31	34
Flash point, °C	71	83	98	107
Pour Point, °C	26	28	30	32
Water content, vol.%	15	43	70	74
Viscosity, mPa·s *	1000	2400	13000	18000
Mass balance / Oil on surface wt.%	76	70	54	22

*mPa·s = cP (mPa·s: SI-standard / cP: Industrial denotation)

Table 5-3: Example of weathering properties of Yme obtained from the OWM predictions after 12 hours of weathering at 2, 5 and 10 m/s at 15 °C.

Weathering properties	12 hours 15 °C 2 m/s	12 hours 15 °C 5 m/s	12 hours 15 °C 10 m/s	12 hours 15 °C 15 m/s
Evaporation, wt. %	26	30	34	36
Flash point, °C	81	94	110	120
Pour Point, °C	27	29	33	34
Water content, vol.%	27	64	80	80
Viscosity, mPa·s *	800	4000	8500	11000
Mass balance / Oil on surface wt.%	73	68	50	18

*mPa·s = cP (mPa·s: SI-standard / cP: Industrial denotation)

5.3 Predictions of Yme crude oil weathering properties

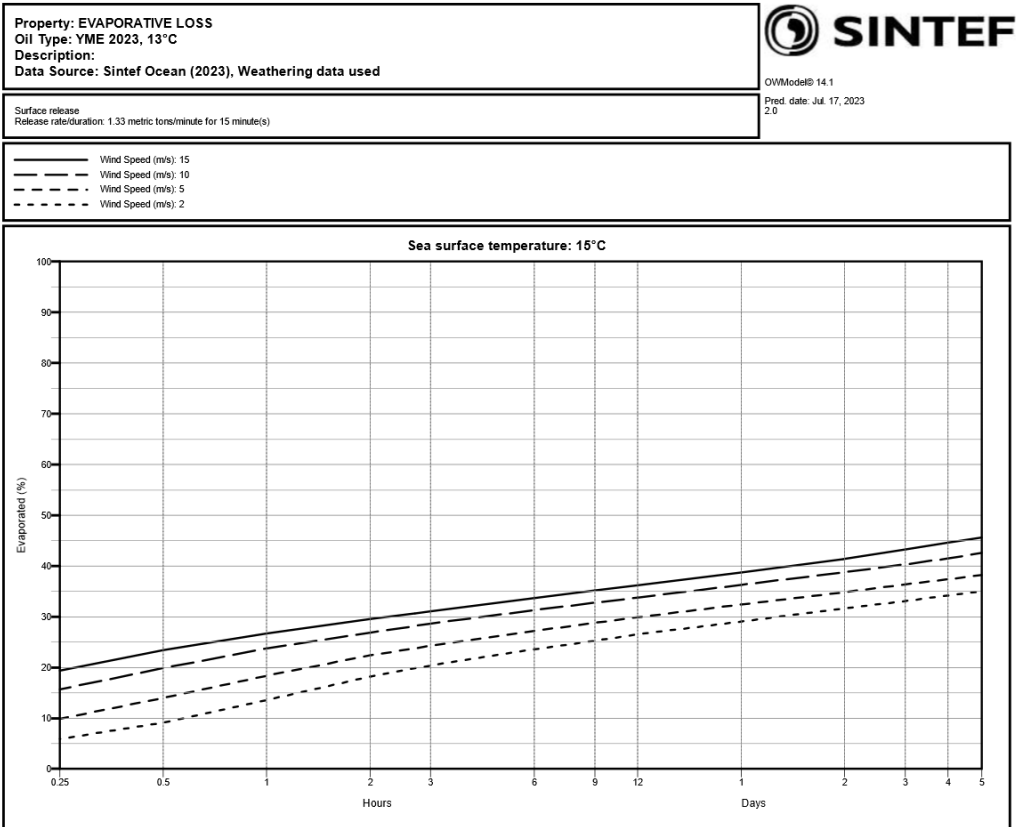
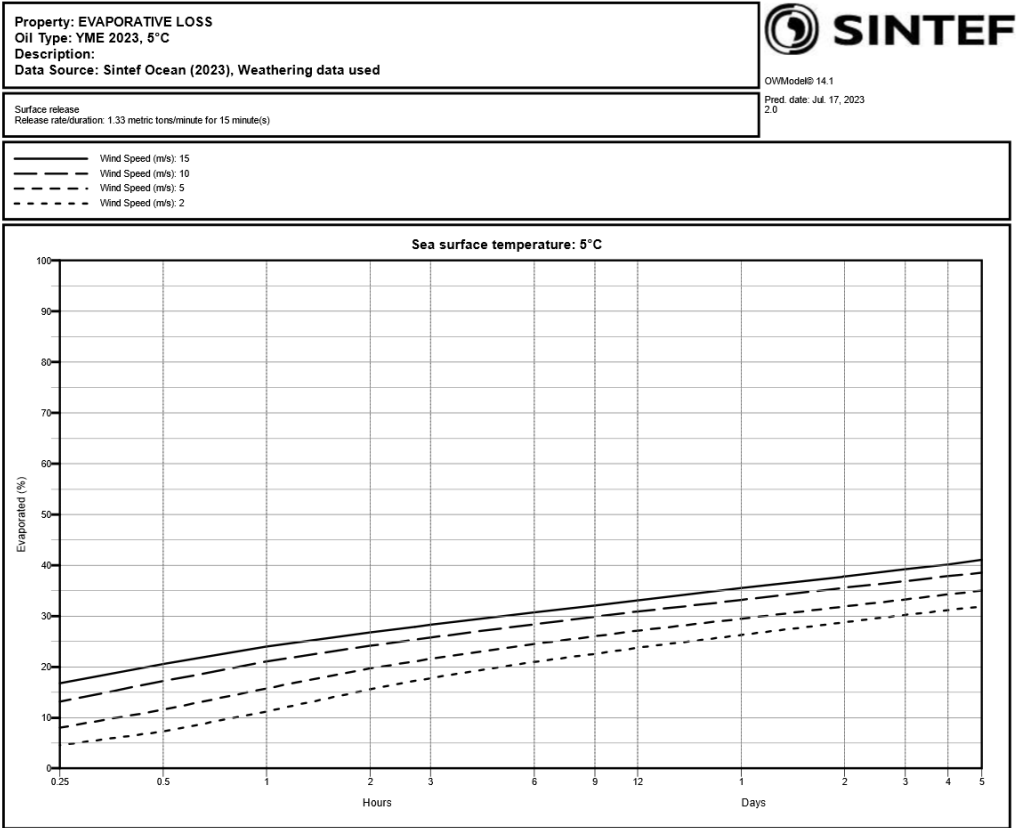

Figure 5-2: Evaporative loss of Yme predicted at sea temperatures of 5 and 15 °C.

Property: FLASH POINT FOR WATER-FREE OIL
Oil Type: YME 2023, 5°C
Description:
Data Source: Sintef Ocean (2023), Weathering data used



OWModel® 14.1
 Pred. date: Jul. 17, 2023
 2.0

Surface release
 Release rate/duration: 1.33 metric tons/minute for 15 minute(s)

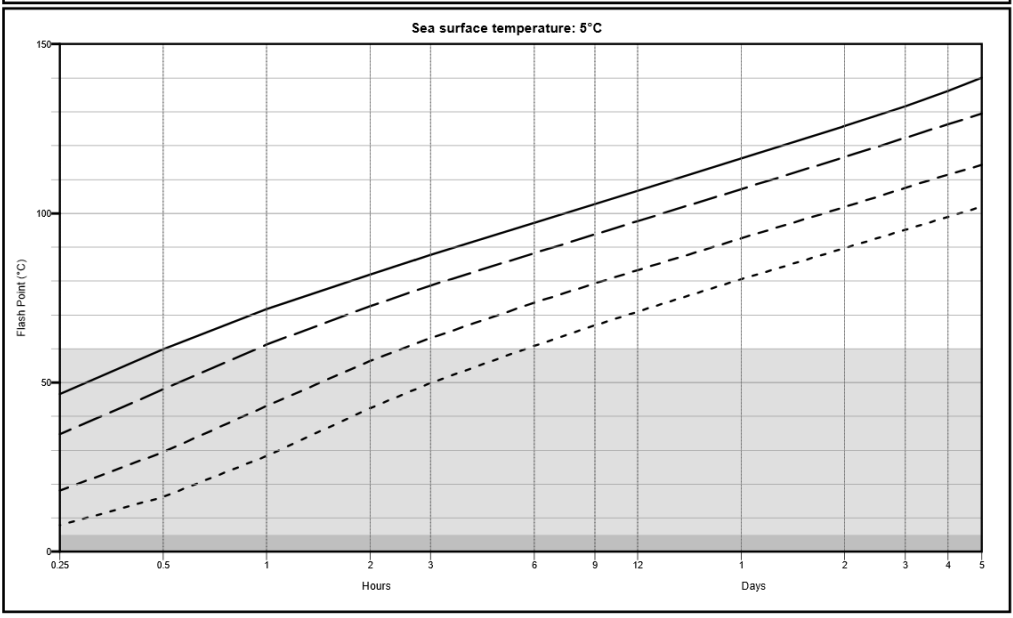
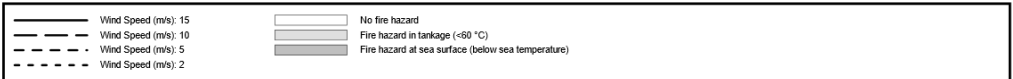

Property: FLASH POINT FOR WATER-FREE OIL
Oil Type: YME 2023, 13°C
Description:
Data Source: Sintef Ocean (2023), Weathering data used



OWModel® 14.1
 Pred. date: Jul. 17, 2023
 2.0

Surface release
 Release rate/duration: 1.33 metric tons/minute for 15 minute(s)

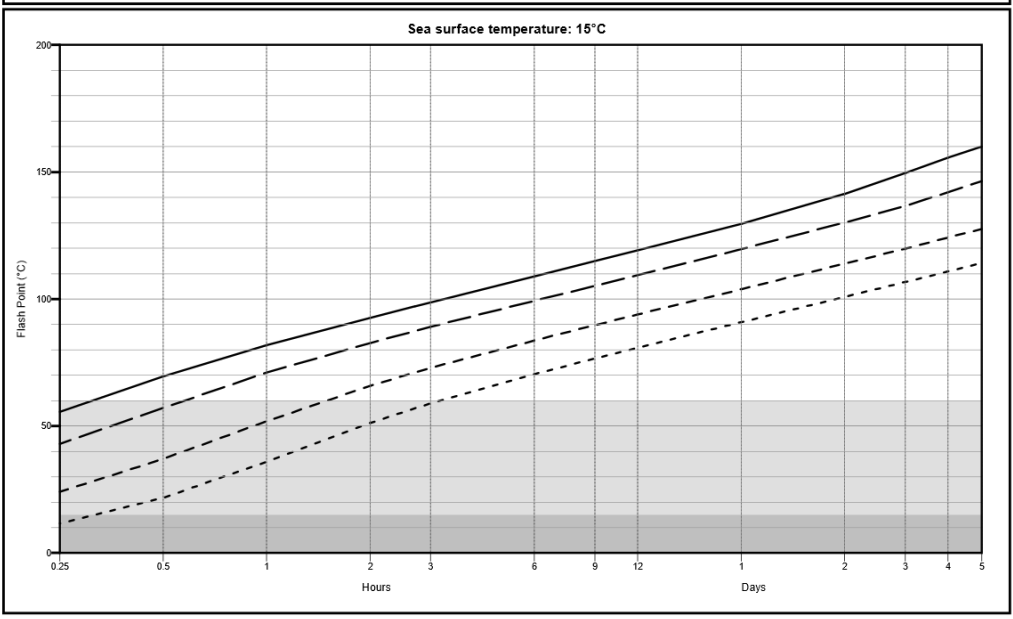
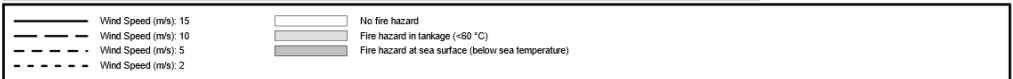

Figure 5-3: Flash point of water-free Yme predicted at sea temperatures of 5 and 15 °C.

Property: POUR POINT FOR WATER-FREE OIL
 Oil Type: YME 2023, 5°C
 Description:
 Data Source: Sintef Ocean (2023), Weathering data used



OWModel® 14.1
 Pred. date: Jul. 17, 2023
 2.0

Surface release
 Release rate/duration: 1.33 metric tons/minute for 15 minute(s)

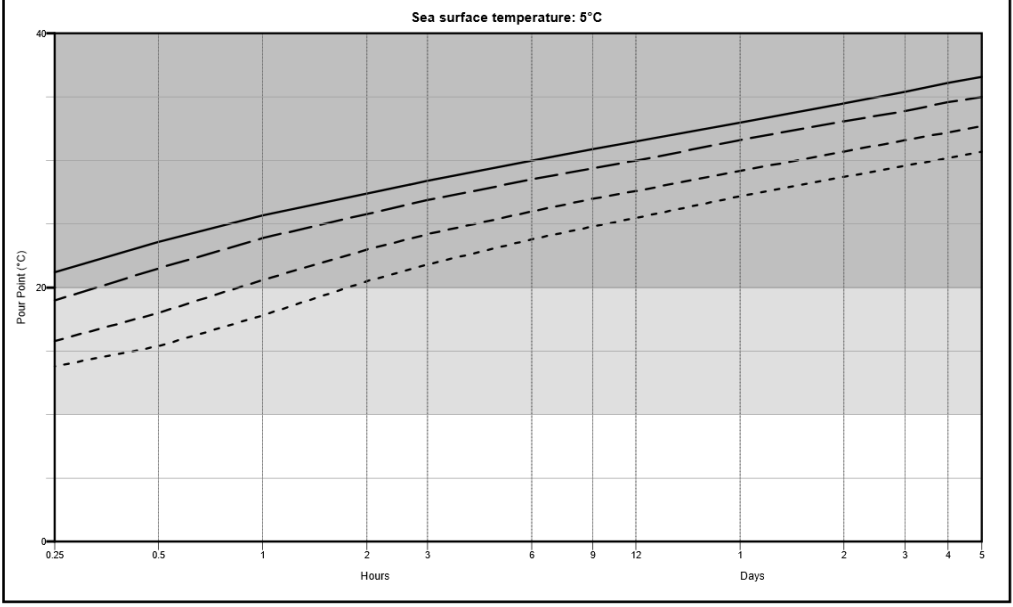
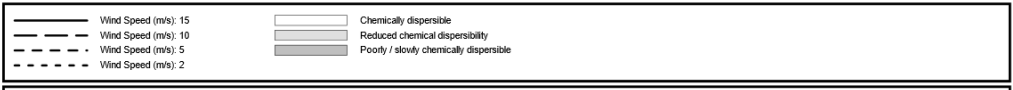

Property: POUR POINT FOR WATER-FREE OIL
 Oil Type: YME 2023, 13°C
 Description:
 Data Source: Sintef Ocean (2023), Weathering data used



OWModel® 14.1
 Pred. date: Jul. 17, 2023
 2.0

Surface release
 Release rate/duration: 1.33 metric tons/minute for 15 minute(s)

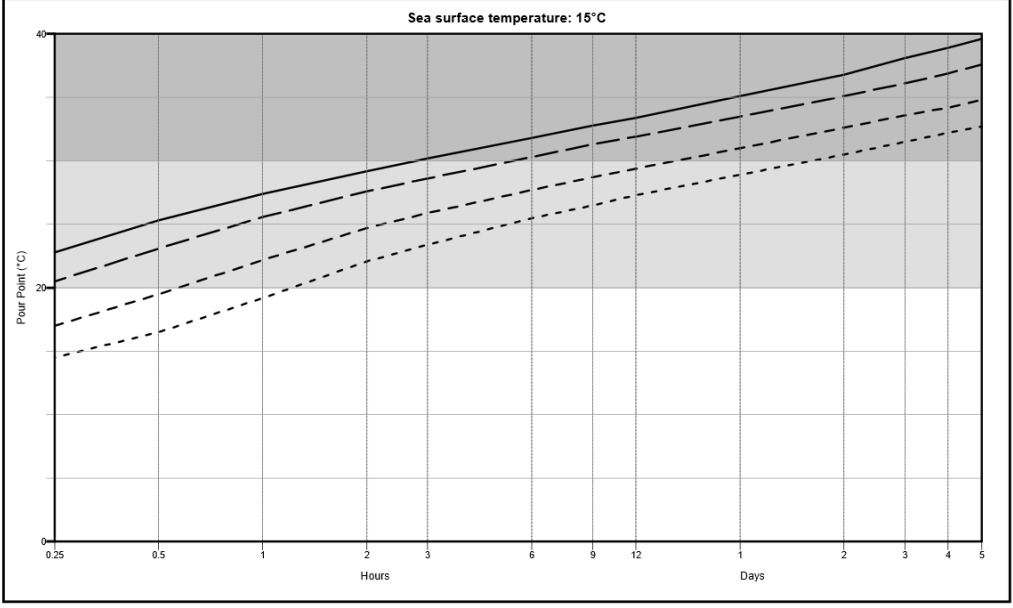
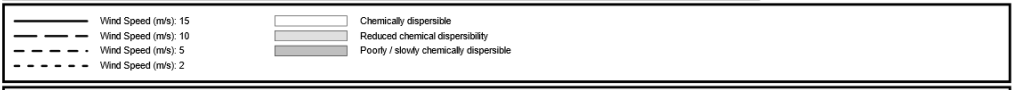

Figure 5-4: Pour point of water-free Yme predicted at sea temperatures of 5 and 15 °C.

Property: WATER CONTENT
 Oil Type: YME 2023, 5°C
 Description:
 Data Source: Sintef Ocean (2023), Weathering data used



OWModel® 14.1
 Pred. date: Jul. 17, 2023
 2.0

Surface release
 Release rate/duration: 1.33 metric tons/minute for 15 minute(s)

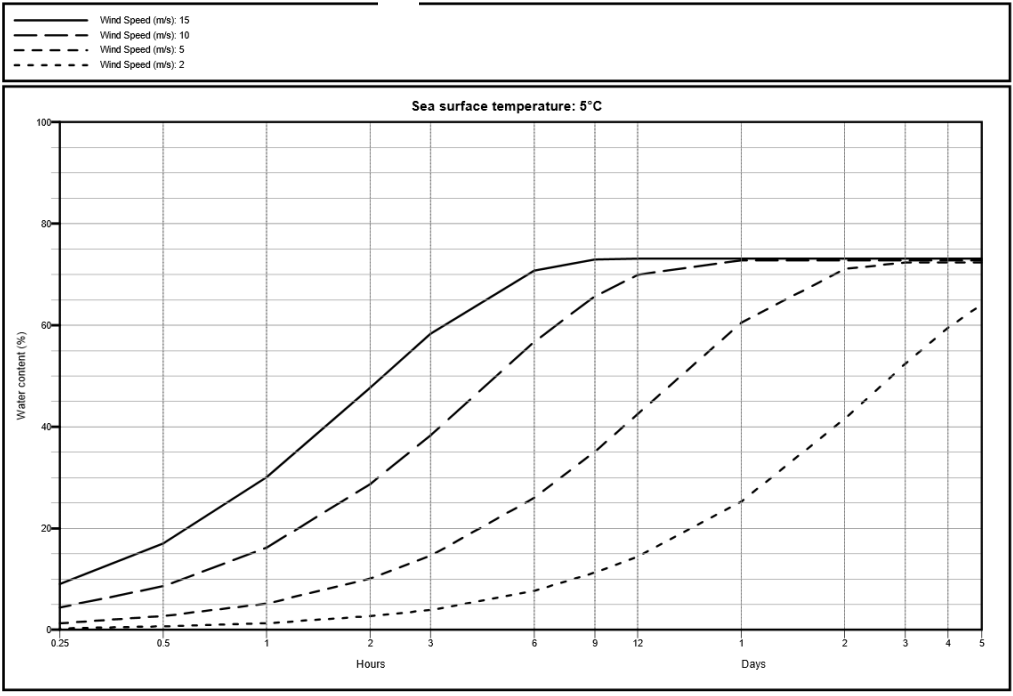

Property: WATER CONTENT
 Oil Type: YME 2023, 13°C
 Description:
 Data Source: Sintef Ocean (2023), Weathering data used



OWModel® 14.1
 Pred. date: Jul. 17, 2023
 2.0

Surface release
 Release rate/duration: 1.33 metric tons/minute for 15 minute(s)

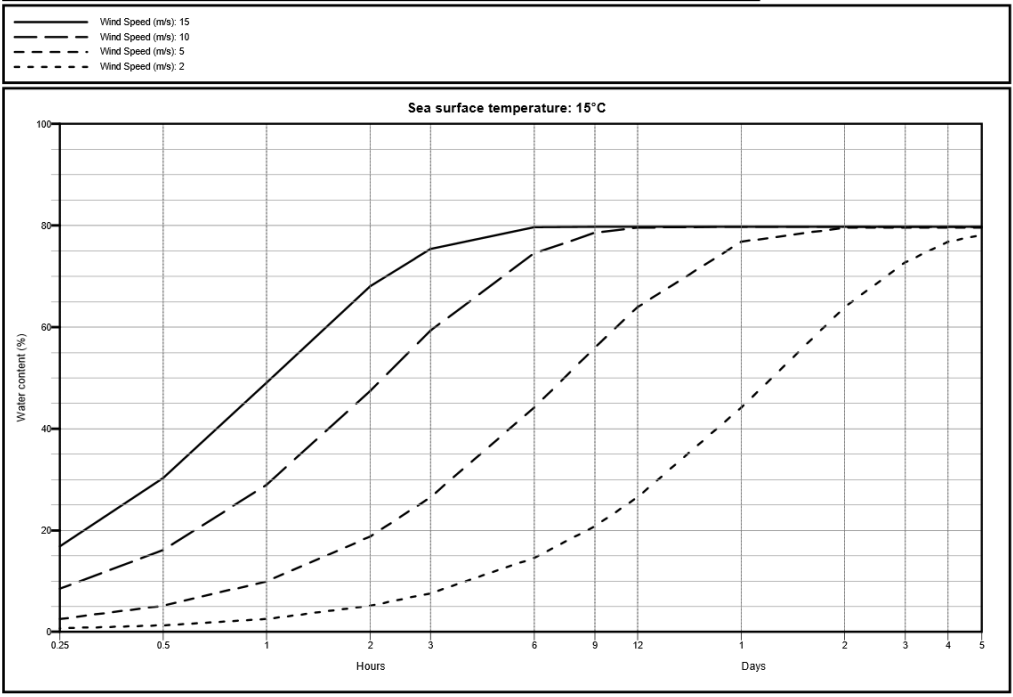

Figure 5-5: Water content of Yme predicted at sea temperatures of 5 and 15 °C.

Property: VISCOSITY OF EMULSION
 Oil Type: YME 2023, 5°C
 Description:
 Data Source: Sintef Ocean (2023), Weathering data used

OWModel® 14.1
 Pred. date: Jul. 17, 2023
 2.0

Surface release
 Release rate/duration: 1.33 metric tons/minute for 15 minute(s)

- Wind Speed (m/s): 15
 - - - Wind Speed (m/s): 10
 - · · Wind Speed (m/s): 5
 - - - - Wind Speed (m/s): 2
- Chemically dispersible (<1,500 mPars)
 - ▒ Reduced chemical dispersibility
 - Poorly / slowly chemically dispersible (>10,000 mPars)

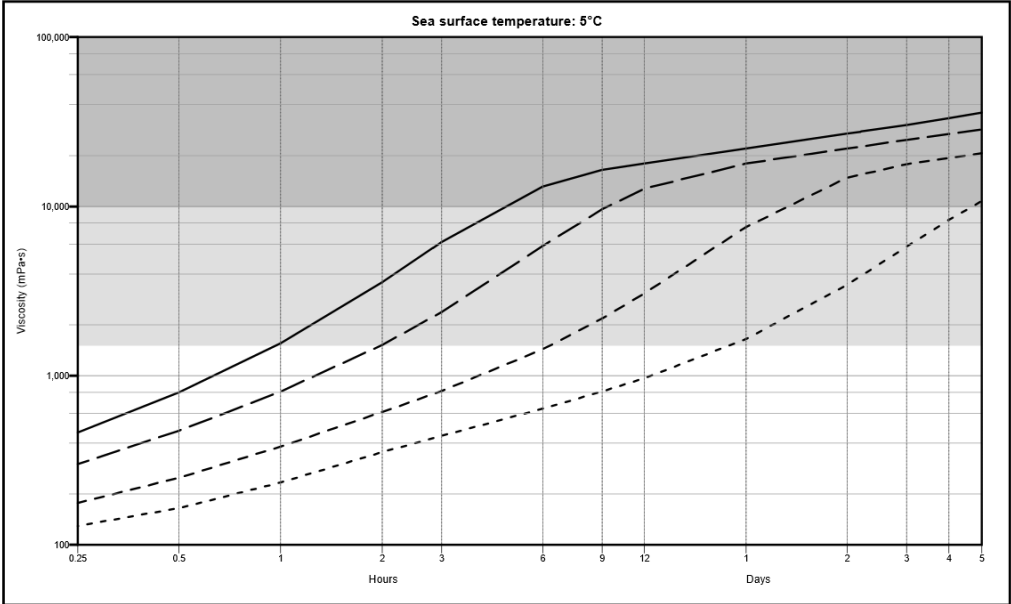

Property: VISCOSITY OF EMULSION
 Oil Type: YME 2023, 13°C
 Description:
 Data Source: Sintef Ocean (2023), Weathering data used

OWModel® 14.1
 Pred. date: Jul. 17, 2023
 2.0

Surface release
 Release rate/duration: 1.33 metric tons/minute for 15 minute(s)

- Wind Speed (m/s): 15
 - - - Wind Speed (m/s): 10
 - · · Wind Speed (m/s): 5
 - - - - Wind Speed (m/s): 2
- Chemically dispersible (<1,500 mPars)
 - ▒ Reduced chemical dispersibility
 - Poorly / slowly chemically dispersible (>10,000 mPars)

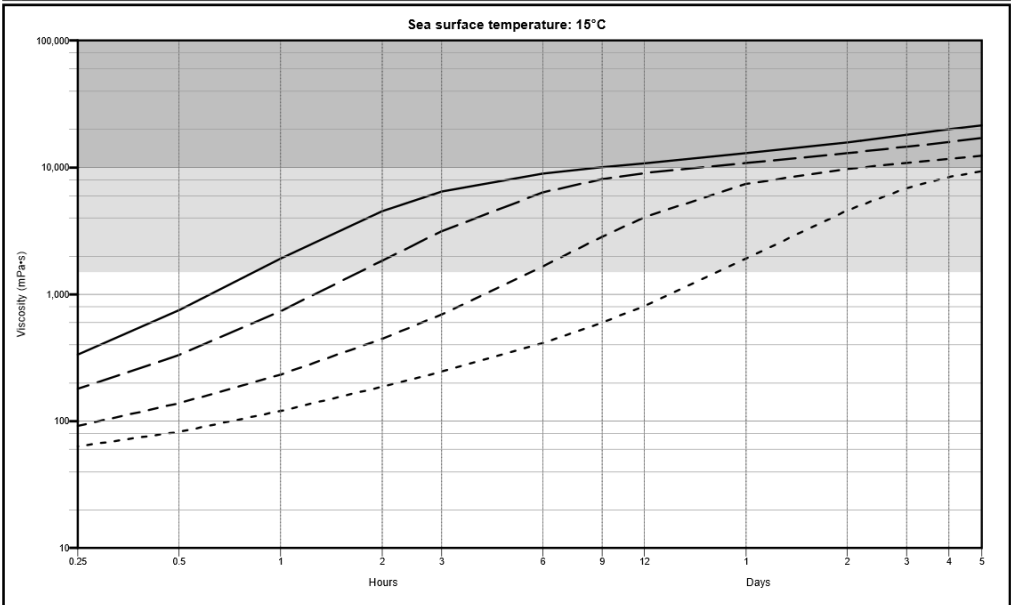

Figure 5-6: Viscosity of Yme predicted at sea temperatures of 5 and 15 °C.

Property: MASS BALANCE
 Oil Type: YME 2023, 5°C
 Description:
 Data Source: Sintef Ocean (2023), Weathering data used

OWModel® 14.1
 Pred. date: Jul. 17, 2023

Surface release
 Release rate/duration: 1.33 metric tons/minute for 15 minute(s)

 Evaporated
 Surface
 Naturally dispersed

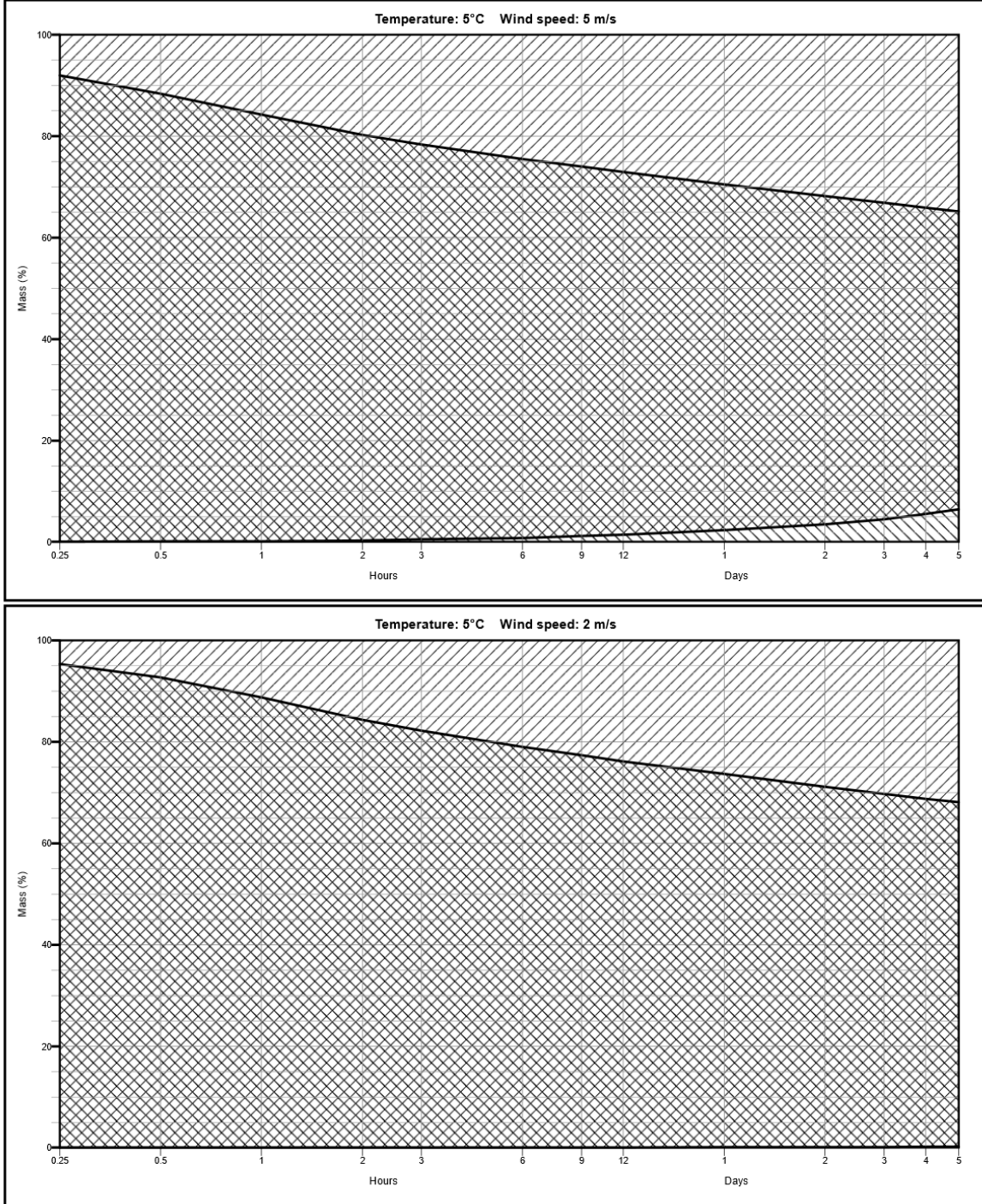

Figure 5-7: Predicted mass balance of Yme predicted 5 °C, wind speeds of 5 and 2 m/s.

Property: MASS BALANCE
 Oil Type: YME 2023, 5°C
 Description:
 Data Source: Sintef Ocean (2023), Weathering data used

OWModel® 14.1
 Pred. date: Jul. 17, 2023

Surface release
 Release rate/duration: 1.33 metric tons/minute for 15 minute(s)

 Evaporated
 Surface
 Naturally dispersed

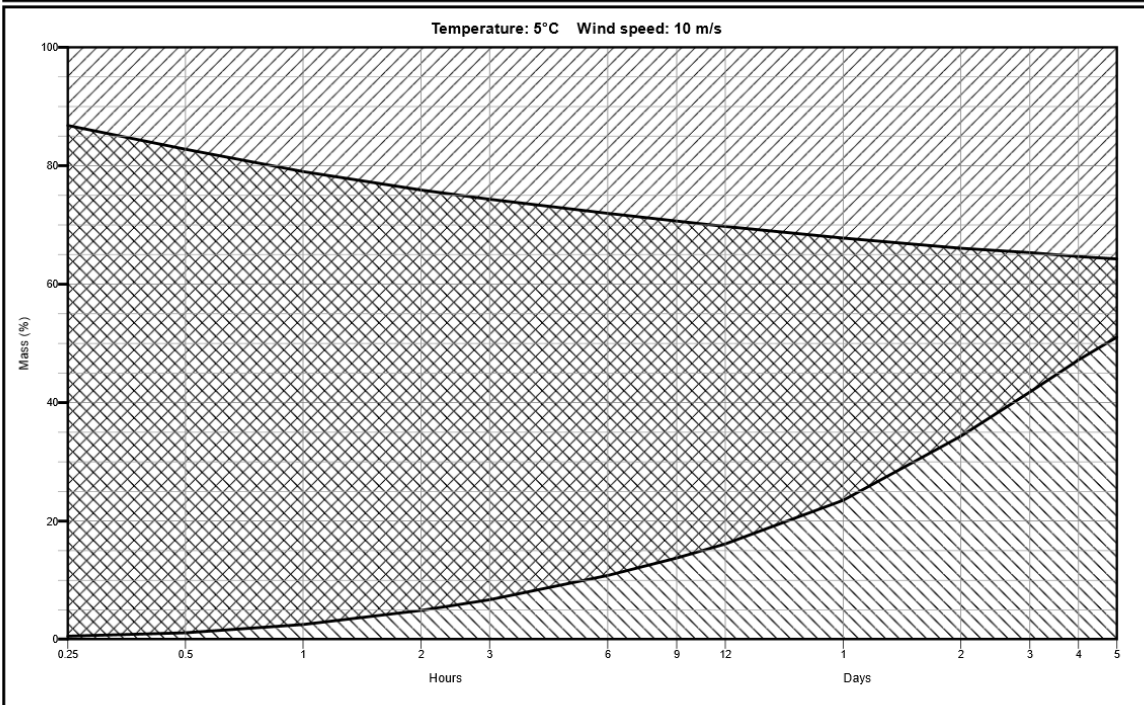
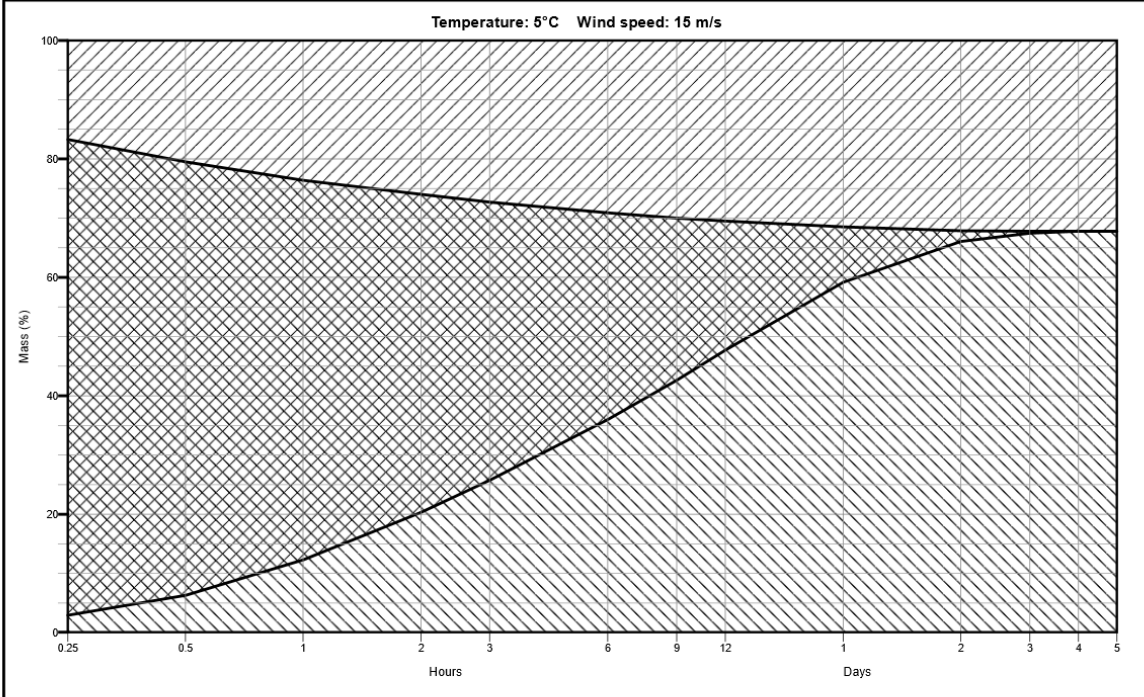

Figure 5-8: Predicted mass balance of Yme predicted 5 °C, wind speeds of 15 and 10 m/s.

Property: MASS BALANCE
 Oil Type: YME 2023, 13°C
 Description:
 Data Source: Sintef Ocean (2023), Weathering data used

OWModel® 14.1
 Pred. date: Jul. 17, 2023

Surface release
 Release rate/duration: 1.33 metric tons/minute for 15 minute(s)

 Evaporated
 Surface
 Naturally dispersed

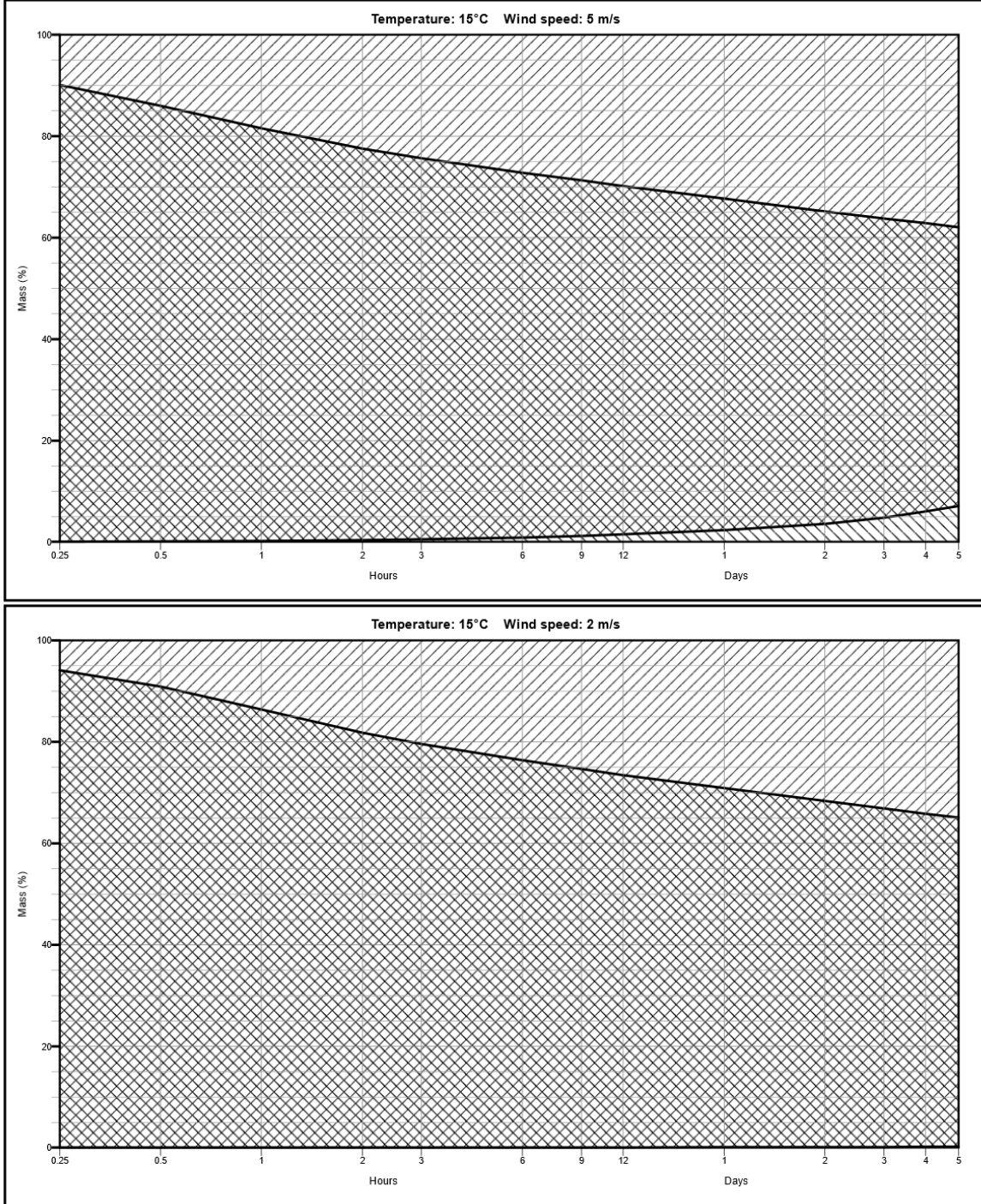

Figure 5-9: Predicted mass balance of Yme predicted 15 °C, wind speeds of 5 and 2 m/s.

Property: MASS BALANCE
 Oil Type: YME 2023, 13°C
 Description:
 Data Source: Sintef Ocean (2023), Weathering data used

OWModel® 14.1
 Pred. date: Jul. 17, 2023

Surface release
 Release rate/duration: 1.33 metric tons/minute for 15 minute(s)

 Evaporated
 Surface
 Naturally dispersed

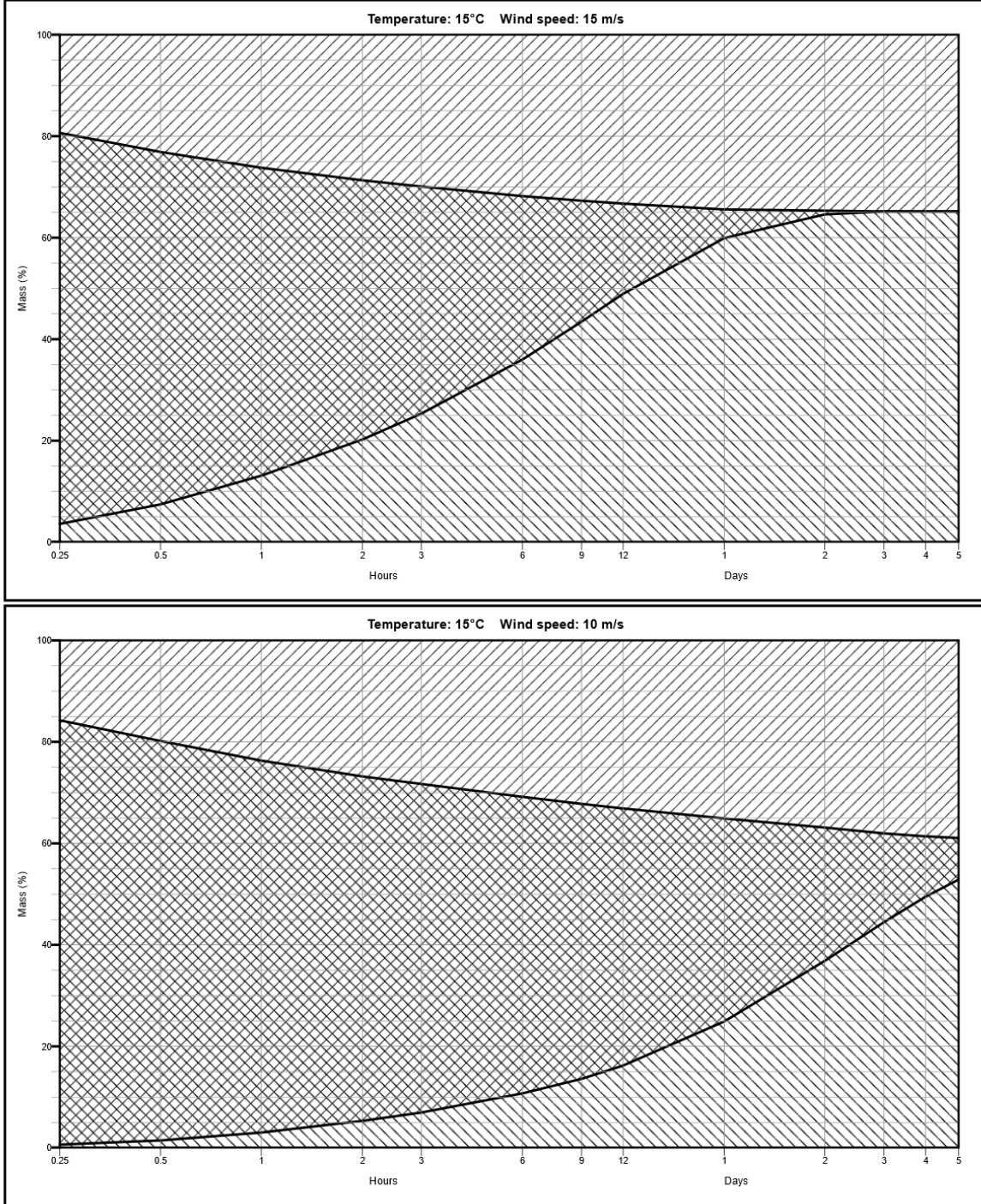

Figure 5-10: Predicted mass balance of Yme predicted 15 °C, wind speeds of 15 and 10 m/s.

6 Comparison of OWM predictions

Weathering predictions from surface release of Yme were compared with predictions of Ula, Oda, Bream, Rev and Blane. The prediction scenario for comparison is based on sea temperature of 15 °C (summer conditions) and wind speed of 10 m/s.

6.1 Evaporative loss

Evaporation is one of the natural processes that helps reducing the surface oil volume if the oil is spilled at sea (Figure 6-1). Yme was found to have similar predicted evaporative loss as the Ula crude oil, while both Oda and Blane are predicted to have slightly higher evaporative loss. Rev condensate has a high predicted evaporative loss, whereas Bream has the lowest predicted evaporative loss.

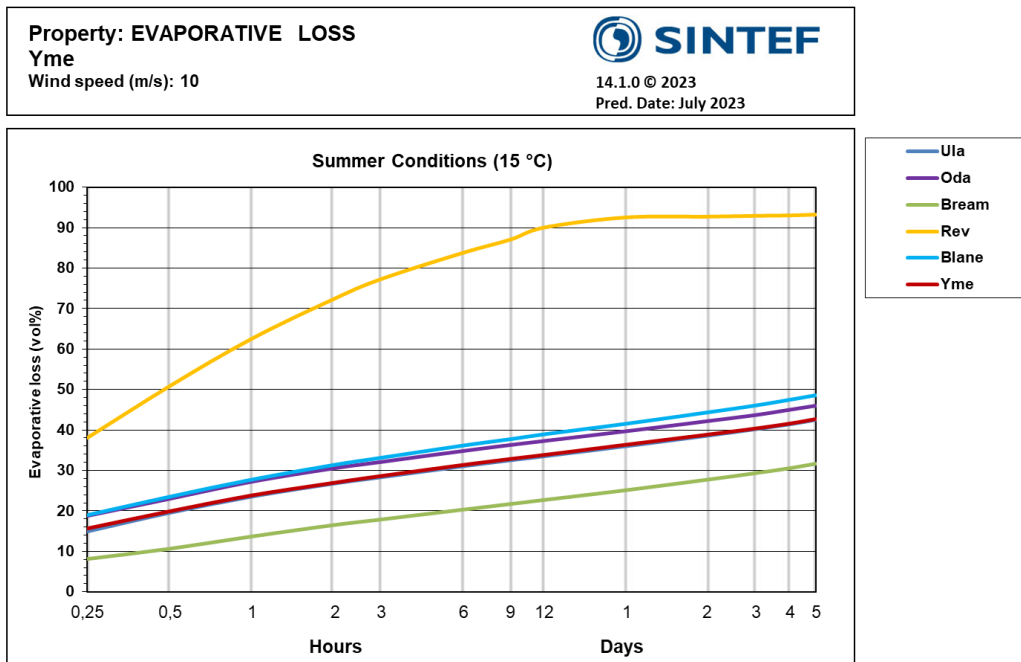

Figure 6-1: Predicted evaporative loss at 15 °C and 10 m/s for Yme in comparison with Ula, Oda, Bream, Rev and Blane.

6.2 Flash point

In general, oils spilled on the sea surface will be cooled to the ambient water temperature within a short period. The probability of fire hazard will be high if the flash point of the oil is below the sea temperature. Moreover, fire hazard is dependent upon the concentration of volatile components in the oil, and the potential for fire is usually surpassed within the first few minutes of a spill due to the rapid evaporation of those components.

The flash points of Yme compared with Ula, Oda, Bream, Rev and Blane is shown in Figure 6-2. All oils are predicted to reach the “No fire hazard” zone within 15 minutes on the sea surface. The flash point of Rev increases rapidly, reflecting the high evaporative loss of this condensate, while the remaining oils show similar development of predicted flash point. Yme has the second highest predicted flash point, somewhat higher than that predicted for Blane.

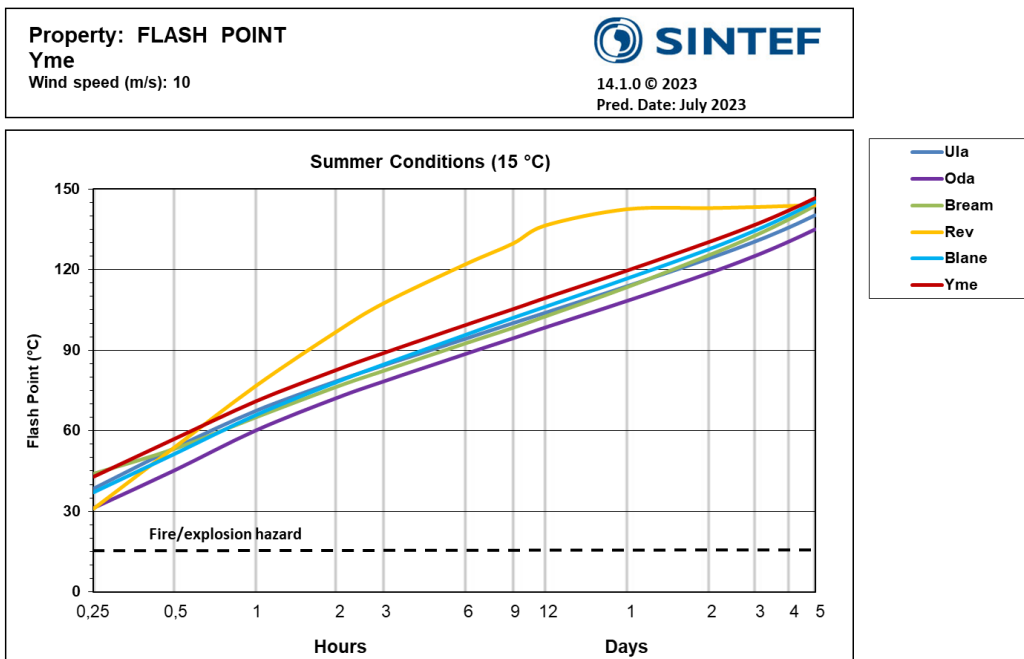

Figure 6-2: Predicted flash point at 15 °C and 10 m/s for Yme in comparison with Ula, Oda, Bream, Rev and Blane.

6.3 Pour point

The pour points of Yme and Ula, Oda, Bream, Rev and Blane are shown in Figure 6-3. Yme is predicted to have the highest pour point of all presented oils. Rev has the lowest pour points after 5 days of weathering compared with the other oils, and solidification at sea is not likely for the condensate.

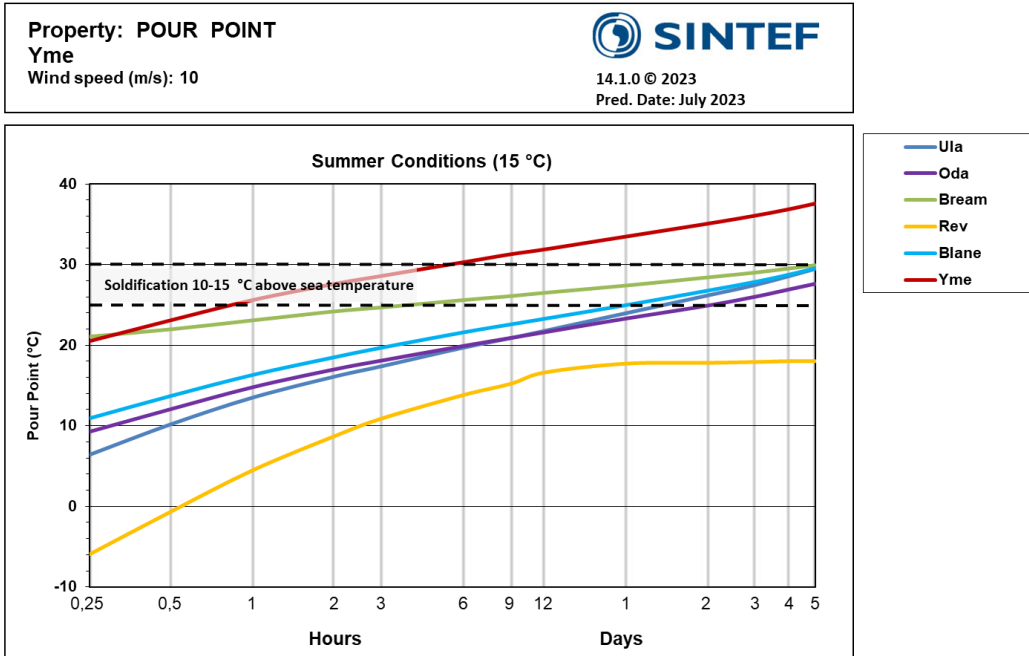

Figure 6-3: Predicted pour point at 15 °C and 10 m/s for Yme in comparison with Ula, Oda, Bream, Rev and Blane.

6.4 Water uptake

The water uptake of Yme compared with Ula, Oda, Bream, Rev and Blane is shown in Figure 6-4. Ula is predicted to have a very rapid water uptake due to rapid kinetics from the lab. study, while Rev condensate has a low and slow water uptake. The predicted water uptake of Yme is intermediate those of Oda and Blane and reach the similar maximum water uptake as these two oils (~80 vol.%). Compared to these three oils, Bream has a similar, though slower water uptake and reach a lower maximum water content of about 75 vol. %.

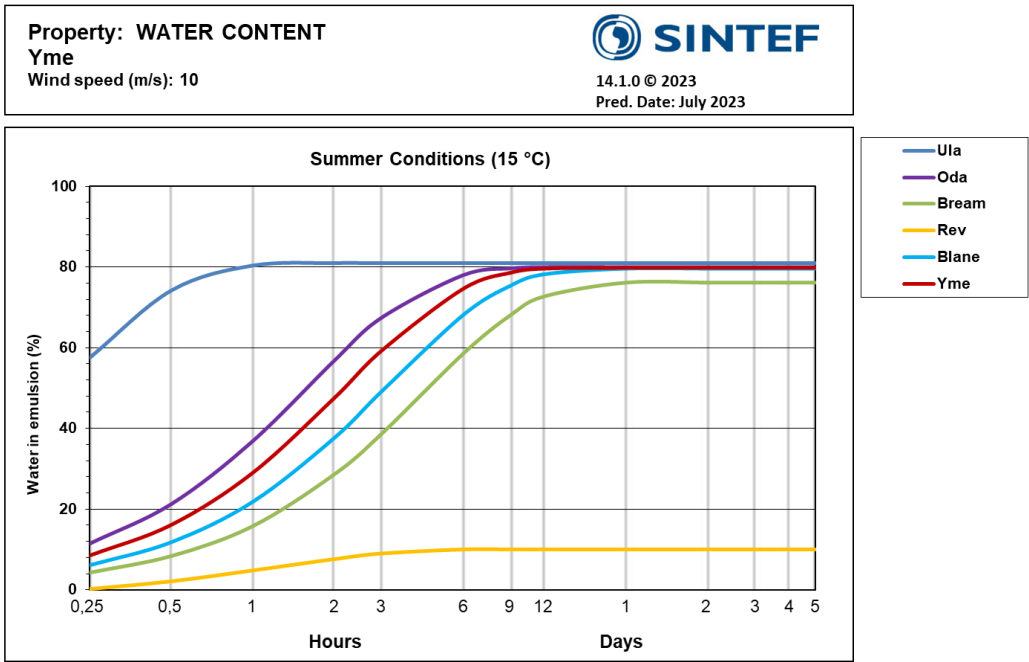

Figure 6-4: Predicted water uptake at 15 °C and 10 m/s for Yme in comparison Ula, Oda, Bream, Rev and Blane

6.5 Emulsion viscosity

Figure 6-5 shows the predicted (emulsion) viscosities of Yme, Ula, Oda, Bream, Rev and Blane. Due to the variations of weathering properties and behaviour, the presented oils show different development in emulsion viscosity. The increase in viscosity over time is lower for Yme compared to Oda and Blane, and after 24 hours of weathering the predicted emulsion viscosities for Yme and Bream and Ula are quite similar. Rev exhibits the lowest emulsion viscosity among these oils.

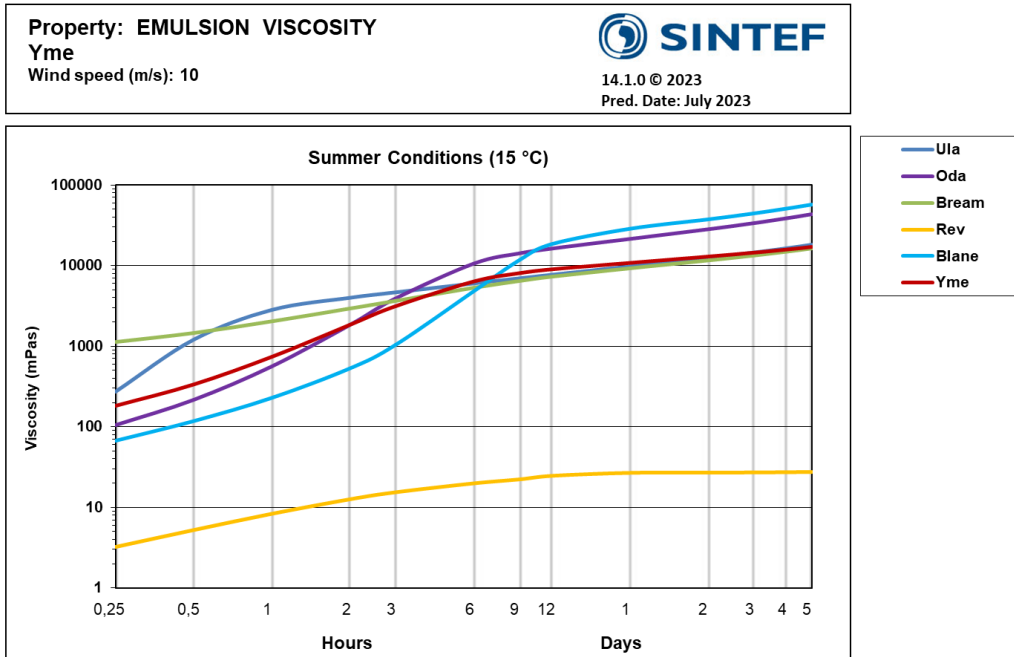

Figure 6-5: Predicted (emulsion) viscosity at 15 °C and 10 m/s for Yme in comparison Ula, Oda, Bream, Rev and Blane.

6.6 Surface oil and emulsion

The predicted surface oil volume is based on the evaporative loss and the natural dispersion/entrainment, whilst surface emulsion also includes emulsification which increase the surface volume. Figure 6-6 and Figure 6-7 show the predicted mass balance of remaining surface oil and surface emulsion, respectively as a function of weathering of the oils in comparison.

Yme show a predicted development in surface oil like Ula, however, Ula exhibits a very different profile for surface emulsion compared to the same oil. This is due to the rapid predicted water uptake for Ula, which quickly increase the emulsion volume on the sea surface while the total waterfree oil amount slowly decreases. The volume of Yme emulsions is predicted to peak after 9 hours on the sea surface under the given conditions, similar to Oda. Moreover, the oils in comparison are all persistent on the sea surface with a predicted lifetime >5 days, except from Rev that is predicted to have a lifetime of 3 hours for this scenario.

Property: Surface oil
 Yme
 Wind speed (m/s): 10

SINTEF
 14.1.0 © 2023
 Pred. Date: July 2023

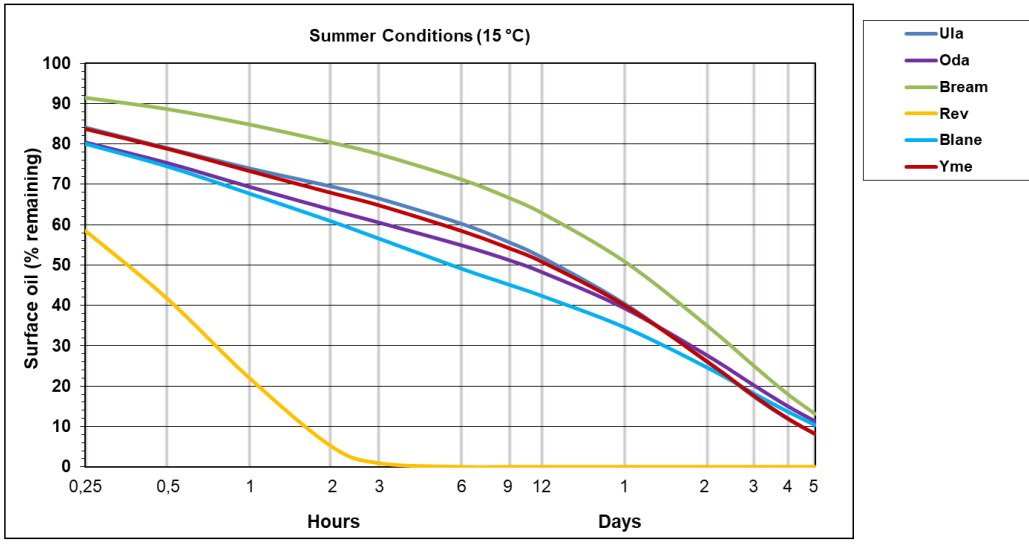

Figure 6-6: Predicted remaining surface oil at 15 °C and 10 m/s for Yme in comparison with Ula, Oda, Bream, Rev and Blane.

Property: Surface emulsion
 Yme
 Wind speed (m/s): 10

SINTEF
 14.1.0 © 2023
 Pred. Date: July 2023

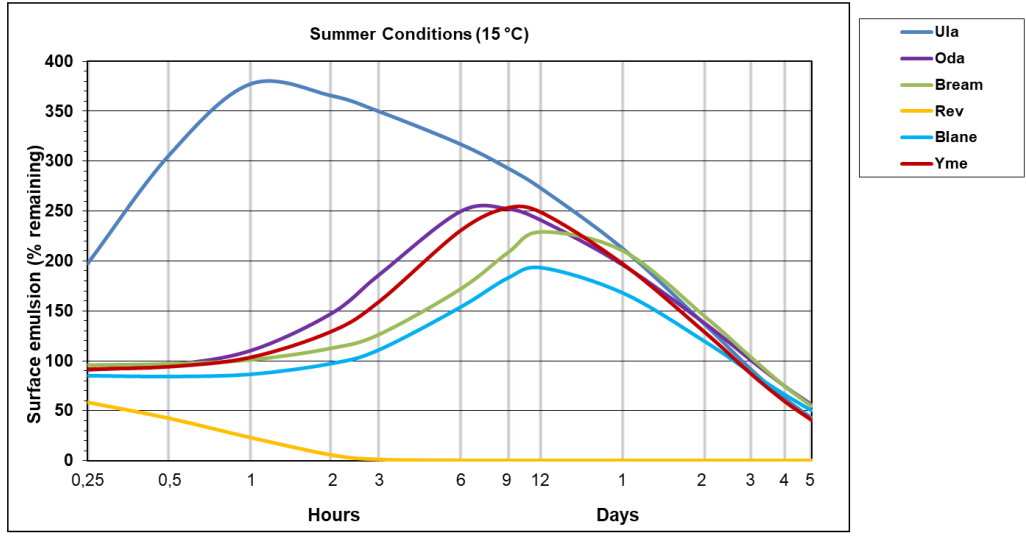

Figure 6-7: Predicted remaining surface oil at 15 °C and 10 m/s for Yme in comparison with Ula, Oda, Bream, Rev and Blane.

7 Weathering properties and response of Yme (surface release)

The relative content of heavy oil components within a spilled oil increases due to evaporation, and the physical and chemical properties of the oil will change over time. Knowledge about how the oils properties change during weathering is therefore important in the management of oil spill response. Mechanical recovery and the use of oil spill dispersants are the main oil spill response options at sea in the Norwegian sector, today. The potential of using water-flushing (artificial energy) to disperse thin oil films is also discussed in this chapter.

7.1 Oil properties

The specific physico-chemical parameters of Yme are input to SINTEF OWM for oil weathering predictions. The physico-chemical analysis of the fresh and topped residues show that Yme is medium paraffinic crude oil with a density of 0.832 g/mL, a wax of 3.4 wt.%, and asphaltenes of 0.54 wt. %. Yme has a moderate evaporative loss of 38 vol.% for the 250°C+ residue. The fresh oil has a relatively high viscosity of 124 mPa.s at 13 °C (10 s⁻¹) compared with many other Norwegian crude oil. The viscosity increases by evaporation of the fresh oil to 3894 mPa.s for the 250°C+ residue. The fresh oil has a pour point of +3 °C that increases significantly to +30 °C upon evaporation (250°C+ residue). Moreover, Yme forms stable water-in-oil emulsions with moderate to high viscosities that partly breaks with application of emulsion breaker (Aerosol OT-SE surfactant).

7.2 Flash point – Fire/explosion hazard

Flash point refers to the lowest temperature at which an oil can vaporize to form an ignitable mixture in the air. In case of an oil release on the sea surface, the oil rapidly will be cooled to the ambient seawater temperature within a short period of time. The potential for fire/explosion hazard will be at its greatest if the flash point of the spilled oil is below the seawater temperature.

The predicted flash point of Yme for the standardized batch release (80 m³/h) shown in Figure 7-1. The flash points for Yme are expected to surpass the sea temperature within short time, approximately 15 minutes at 5 and 15 °C, at wind speeds of 2-15 m/s. Less than 1-hour delay time related to fire/explosion hazard related to the flash point of the drifting oil itself. The release rate may influence on the rate of evaporation, and for considerably larger (batch) release rates e.g., 100 times higher (8000 m³/h), the rate of evaporative loss can thus be reduced particularly for the first hours after the release due to thicker oil layer. Such high batch releases could be for example incident scenarios in connection to blowouts, pipeline ruptures or tanker loadings.

Moreover, some vessels/storage tanks engaged in oil recovery operations may not be classified to carry liquids with flash points lower than 60 °C. This may be the case for towing vessels, smaller cargo, or other vessels available in an emergency. However, for oil recovery vessels (e.g., NOFO's ORO vessels) with A class certification for transport of liquids (Class I/II, flash point <60 °C), there should not be any risks in storing the recovered emulsion in such tanks. According to NOFO's "ORO-manual" the aeration tubes should be place minimum 2.4 m above deck-levels, and aeration Zones (ex-zones) will be established onboard, that will be manually controlled with explosimeters during a response operation. For Yme, the tank storage limit is predicted to be surpassed within 3 hours in summer temperatures and within 6 hours in winter temperatures, for the calmest wind conditions.

As a general recommendation after an acute oil spill involving free gas (e.g., from an oil/gas blowout), a "safety" zone typically 1-2 km from the source should be established early on and downwind from the spill site before response actions are initiated in open seawaters. Prior to the initiation of spill response operations, an evaluation of fire/explosion hazard must always be conducted at the site. Explosimeters should be utilized continuously, and one should be aware of the possibility for varying release rates if "free" gas is involved.

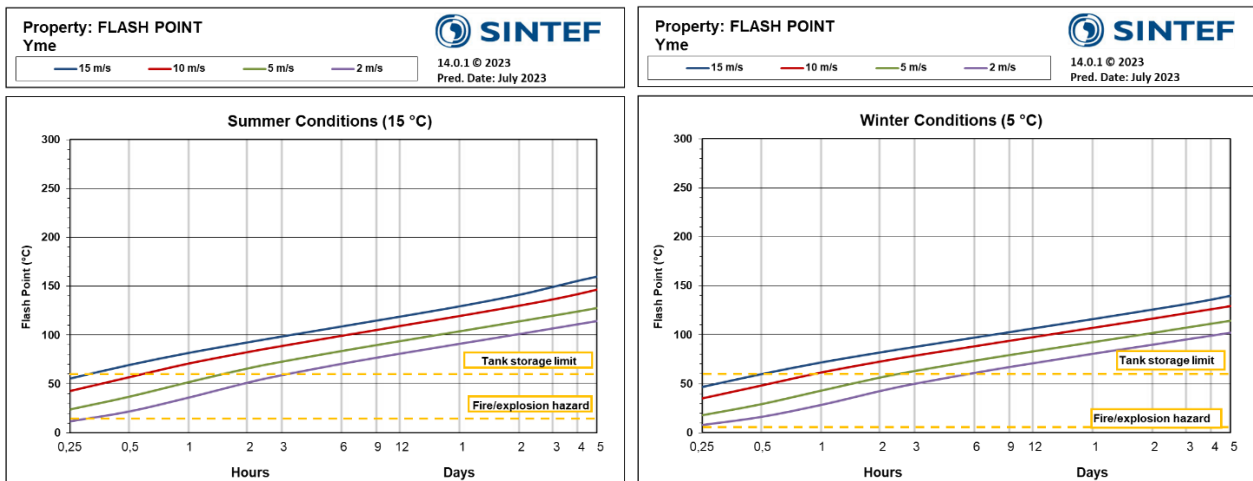

Figure 7-1: Predicted flash points for Yme with a release rate of 80m³/h.

7.3 Solidification

Pour point depends on the oil's wax content and the amounts of light components that can keep the wax components dissolved in the oil phase. In addition, contents of asphaltenes may prevent or reduce precipitation and lattice formation and hence lowers the pour point. High pour points may prevent the dispersant to soak into the oil slick and influence the dispersant effectiveness and may also reduce the potential for flowability towards weir skimmers. In cases when high viscosities are not a limiting factor, high pour points may cause solidification (elastic properties) of semi-solid patches when oil is spilled on the sea surface. High pour point may therefore imply solidification on the sea surface immediately after the release, and this is pronounced when the pour point is typically 5-15 °C above sea temperature and in cold temperatures.

Yme has high pour points of its residues (24-30 °C), and a possible remaining water-free residue may therefore have a potential to solidify at sea, particularly in winter condition as shown for the pour point prediction in Figure 5-4, page 37.

7.4 Emulsion formation

The total amount of oil on the sea is reduced due to evaporation and natural dispersion in the early stages of weathering. However, as water is mixed into the oil and emulsions are formed, the total volume will increase. Figure 7-2 shows the predicted mass balance of remaining surface emulsion and surface oil as a function of weathering of Yme at 10 m/s windspeed at 5 and 15 °C.

Due to a high water uptake of the oil at summer temperature, the predicted surface emulsion reaches about 2.5 times the volume of the spilled oil in summer conditions. Lower and slower water uptake in winter conditions is predicted to limit the total volume increase to less than twice the spilled oil volume.

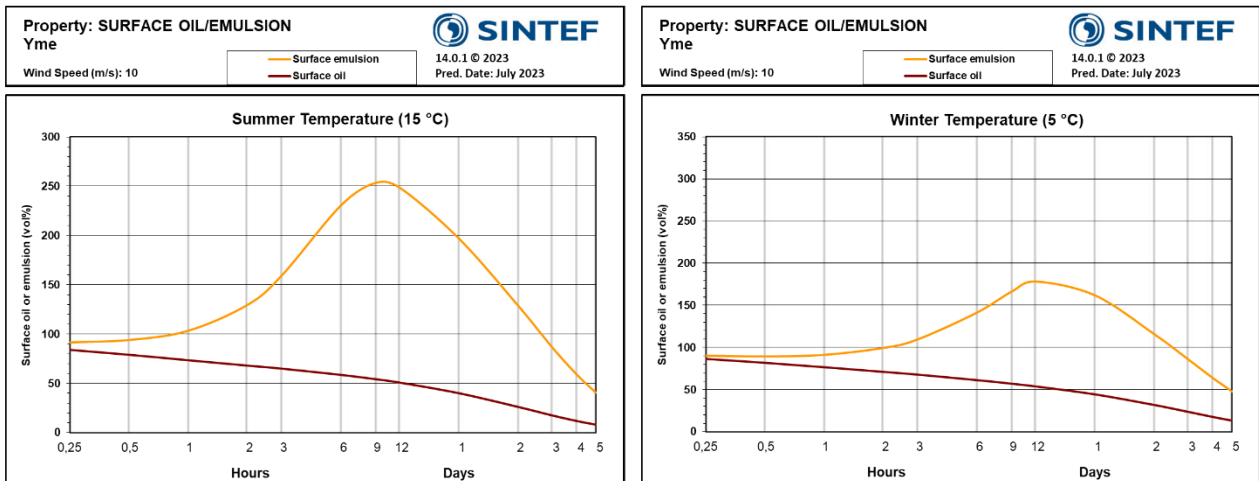

Figure 7-2: Difference in the total slick volume due to emulsification compared to non-emulsified oil of Yme. Decrease in total volume due to evaporation and natural dispersion at 10 m/s wind speed at temperatures of 5 °C and 15 °C.

7.5 Entrained oil and evaporation

The lifetime of an oil spill at sea depends on the oil’s composition, the release conditions (e.g., on the surface, underwater) and environmental conditions (temperature, wind, waves). Entrained oil and evaporation are the main weathering processes that reduce the surface oil volume from a spill. The remaining surface oil after a release depends on the wind speeds and typically oils are more persistent on the sea surface with lower wind.

Figure 7-3 shows the predicted remaining surface oil over time for different wind speeds at 5 and 15 °C for Yme. There is some minor difference in lifetime between 5 and 15 °C for Yme. At high wind speeds of 15 m/s, no oil is predicted to remain on the sea surface after 2-3 days of weathering at 5 and 15 °C. Lower wind speeds will not provide sufficient energy to remove Yme entirely from the surface within the first 5 days. For the lowest wind speed (2 m/s), the prediction indicates about 65-68 % of the spilled oil remains on the sea surface after 5 days. Considerably larger spills are expected to produce longer lifetimes, and specific modelling may be necessary.

There are clear differences in predicted behaviour between summer and winter conditions. In winter, the surface oil is predicted to have a slow and steady decrease, with little impact of wind conditions. In summer temperatures, wind conditions will greatly influence the rate of removal of surface oil (through evaporation or dispersion/natural entrainment).

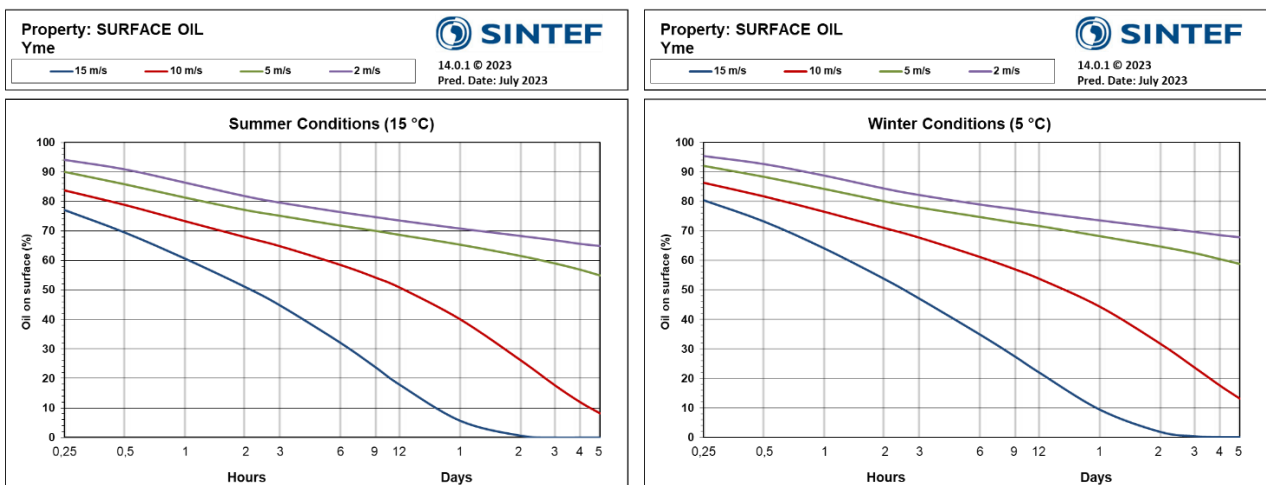

Figure 7-3: Remaining surface oil under different sea states for Yme at 5 °C and 15 °C.

7.6 Film thickness from surface release

In general, mechanical recovery requires normal minimum film thickness $>0.1-0.2$ mm. Film thickness $>0.05-0.1$ mm is considered for application of oil spill dispersants. Lower film thicknesses are likely to disperse naturally under breaking waves conditions and may be enhanced in non-breaking waves by mechanical dispersion (chapter 7.8). Figure 7-4 shows the predicted film thickness of Yme for a surface release at 5 and 15 °C with an initial surface release of 80 m³/h, if the initial film thickens of the oil is sufficient high to emulsify, i.e., typically >0.1 mm. The increase in film thickness after few hours is due to emulsification that is most pronounced at 15 °C (summer conditions) than at 5 °C (winter conditions). Yme is predicted to retain a sufficiently thick film for mechanical recovery and use of chemical dispersants. Other factors than film thickness should also be considered when evaluate response options, as described in the next chapters.

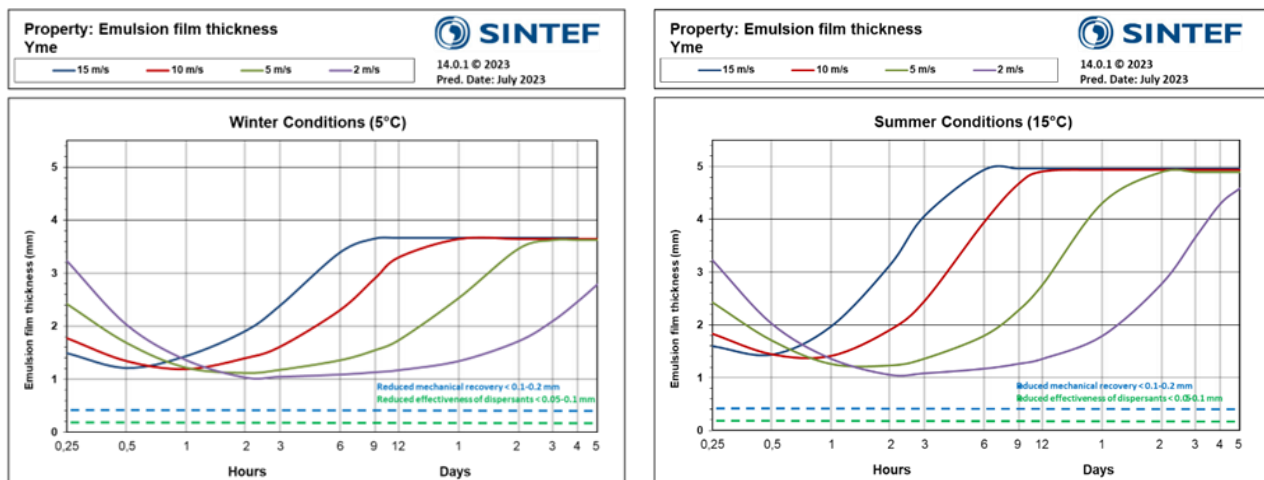

Figure 7-4: Predicted film thickness of Yme emulsion from a surface (batch) release at 5 and 15 °C with terminal film thickness of 1 mm water-free oil (80 m³/h).

7.7 Mechanical recovery by boom and skimmer

Experiences from Norwegian field trials with booms have demonstrated that the effectiveness of various mechanical clean-up operations may be reduced due to the high degree of leakage of the confined oil or emulsion from the oil spill boom. Boom leakage is particularly pronounced if the viscosity of the oil or the w/o-emulsion is lower than 1000 mPa·s (Nordvik et al., 1992). The lower viscosity limit for an optimal mechanical clean-up operation has therefore been estimated to 1000 mPa·s. However, other factors like the operational speed of recovery vessel and current weather conditions will also influence on the risk of boom leakage.

Generally, for many oils, weir skimmers may reduce recovery rates (m³/h) when skimming oils with viscosities in the range 15-20 000 mPa·s (Leirvik et al., 2001). NOFO is operating with viscosity limits for skimmer efficiency as followed: primary use of weir skimmers (<20 000 mPa·s), combination of weir and HiVisc. skimmers (20-50 000 mPa·s), and primary HiVisc. skimmer (>50 000 mPa·s).

The emulsion viscosities of Yme are shown in Figure 7-5 at 5 and 15 °C. For boom leakage of confined oil, the emulsion viscosity exceeds 1000 mPa·s between 3-6 hours at 10 m/s wind speed, but the time may be stretched up to about 12 hours to 1-day for very low wind speed (2 m/s). Overall, Yme has a wide window of opportunity for use of traditional weir-skimmer head for viscosities <20 000 mPa·s, about 5 days at summer conditions, and 12 hours-1.5 days at winter conditions for 10-15 m/s wind speeds. In cases if the emulsion exceeds 20 000 mPa·s, that can be the case particularly in low temperatures, a combination of weir and HiVisc. skimmers may be considered.

Property: EMULSION VISCOSITY
Yme

15 m/s 10 m/s 5 m/s 2 m/s

14.0.1 © 2023
 Pred. Date: July 2023

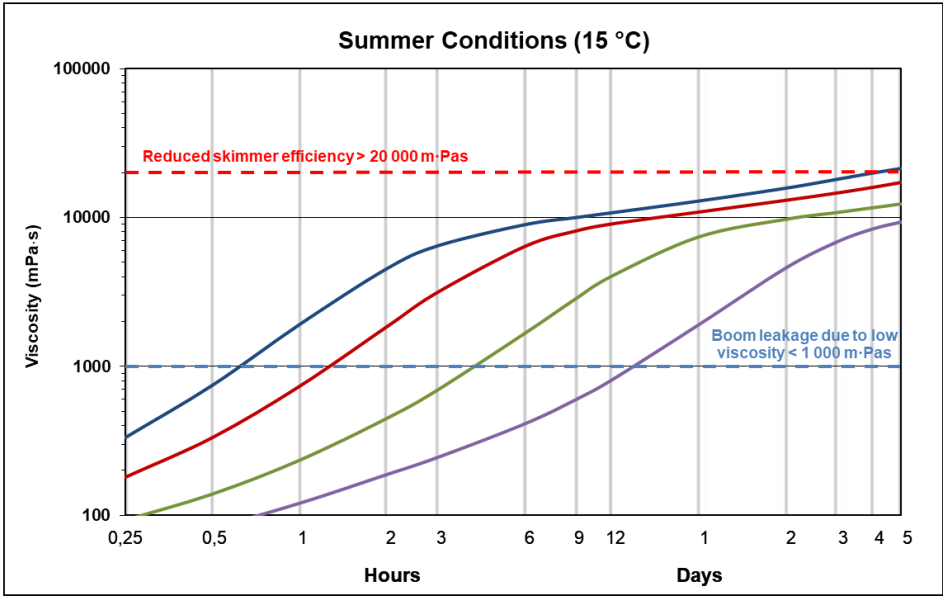

Property: EMULSION VISCOSITY
Yme

15 m/s 10 m/s 5 m/s 2 m/s

14.0.1 © 2023
 Pred. Date: July 2023

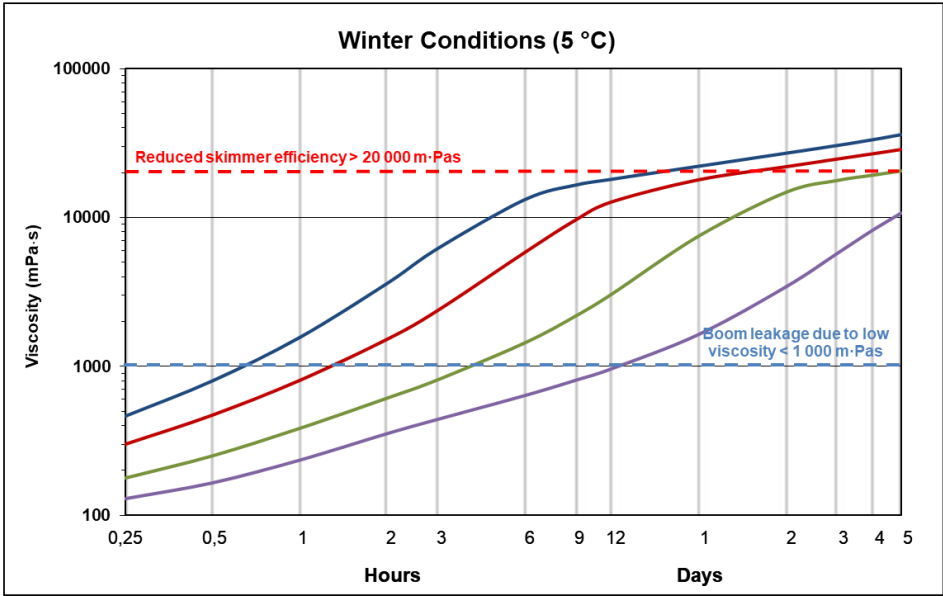

Figure 7-5: Predicted emulsion viscosity for Yme at 5 °C (down) and 15 °C (upper) included expected viscosity limits for boom leakage and poor flow to weir skimmers.

7.8 Mechanical dispersion by high-capacity water flushing

In general, mechanical dispersion by high-capacity water flushing without using dispersants could have a potential for oil spill with thin (initial) film thickness up to 0.2-0.3 mm and viscosities <150-300 mPa·s. In such cases, water flushing from high-capacity water flush boom and/or firefighting (FiFi) systems could possibly break up the oil/residue into smaller droplets and enhance the dispersion into the water column. Moreover, water flushing could also be used in combination with application of dispersant in calm weather condition to enhance dispersant efficiency with use of artificial energy some minutes after the dispersant treatment. This technology was tested in a full-scale trial (NOFO Oil-on-Water trial) in 2016 and described by Daling et al., 2017 and Sørheim et al., 2017.

For Yme mechanical dispersion by water flushing, only, is not considered as a main strategy in oil spill response due to the formation of high emulsion film thicknesses (Figure 7-4) by emulsification, even the oil has low emulsion viscosities in the very early stage after an oil spill, as shown in Figure 7-5. The rapidly emulsification of Yme is the limiting factor for this strategy. However, use of water-flushing can be a supplementary method in "peripheral" areas with thin oil films, e.g., metallic /rainbow appearance.

7.9 Chemical dispersion

The viscosity limit for effective dispersant use was estimated to 1500 mPa·s and the upper viscosity limit for when the emulsified oil is not or poorly dispersible was estimated to 10 000 mPa·s. The viscosity limits were based the low-energy IFP-test (non-breaking waves <5 m/s wind) and the high-energy MNS-test (breaking waves >5 m/s wind) on Yme emulsions. In cases where the oil (emulsion) is expected to be reduced dispersible, additional energy or use of a higher dispersant dosage by repeated dispersant application is recommended to possibly enhance the dispersant efficiency. Providing additional energy through use of FiFi-systems or thrusters after dispersant application may increase the dispersion effectiveness in calm weather conditions.

The window of opportunity for use of dispersant Dasic Slickgone NS with regards to viscosity is presented in Figure 7-6 at 5 and 15 °C. The oil-emulsion is e.g., predicted to be (reduced) dispersible up to about 9 hours in winter conditions, and between 12 hours and 1-day in summer conditions at 10 m/s wind speed, respectively, and longer time-windows in calmer wind speeds (2-5 m/s wind speeds).

Solidification reduces the dispersant effectiveness, as the dispersant droplets will have a reduced ability to migrate into the oil layer and will easily be washed off by wave activity. In certain weather conditions, low emulsification rate may enhance formation of solidified lumps, particularly at winter temperature (5 °C). In a spill situation, the use of a simplified dispersibility testing kit is recommended to assess the potential for chemical dispersion.

Property: EMULSION VISCOSITY
Yme

14.0.1 © 2023
 Pred. Date: July 2023

— 15 m/s — 10 m/s — 5 m/s — 2 m/s

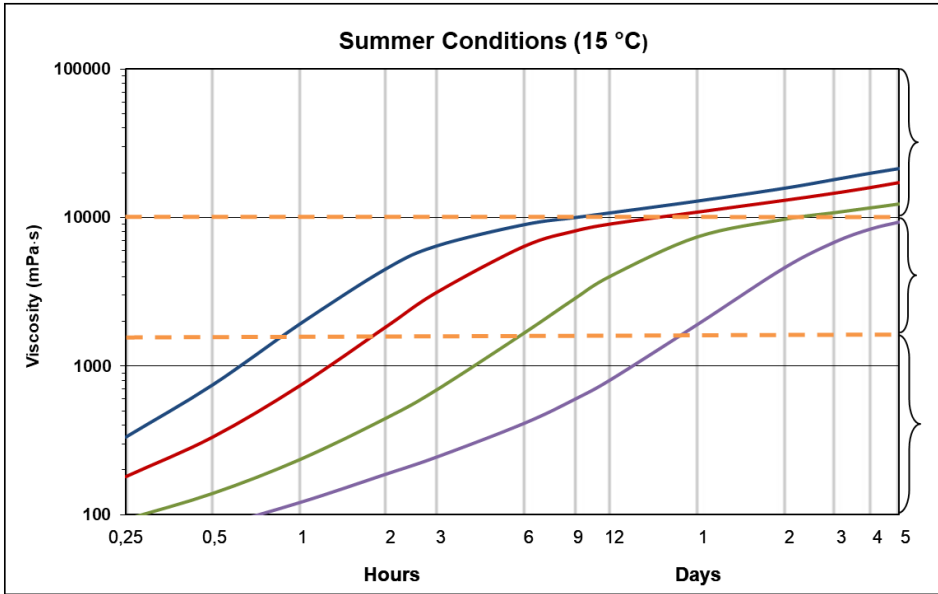

Poorly chemically dispersible
 viscosity > 10 000 mPa·s

Reduced chemical dispersibility
 Viscosity > 1500 mPa·s

Chemical dispersible
 viscosity < 1500 mPa·s

Property: EMULSION VISCOSITY
Yme

14.0.1 © 2023
 Pred. Date: July 2023

— 15 m/s — 10 m/s — 5 m/s — 2 m/s

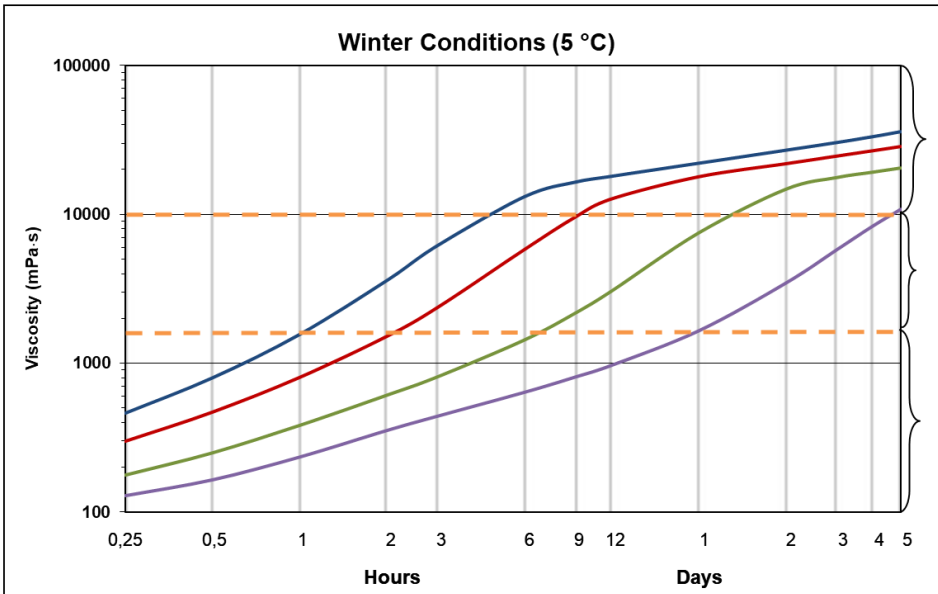

Poorly chemically dispersible
 viscosity > 10000 mPa·s

Reduced chemical dispersibility
 Viscosity > 1500 mPa·s

Chemical dispersible
 viscosity < 1500 mPa·s

Figure 7-6: Predicted emulsion viscosity for Yme at 5 °C (down) and 15 °C (upper) included the dispersibility limits stated in chapter 3.6.3.

8 Summary of response options of Yme

Yme is a medium density paraffinic crude oil that forms stable water-in-oil (w/o) emulsion in scenarios where the (initial) film thickness >0.1 mm. An evaluation of a potential subsurface release has not been evaluated for Yme. However, certain scenarios from underwater releases depending on the water depth, gas to oil ratio (GOR), release rate, release rupture diameter etc. may also produce initial film thicknesses >0.1 mm of surfaced oil, otherwise thinner initial oil films can be expected for subsurface gas/oil releases of e.g., high GORs in shallow waters. Bench-scale dispersant effectiveness of a possible subsurface dispersant injection (SSDI) was not included in this study.

Mechanical recovery:

- Boom leakage and reduced recovery is expected for viscosities <1000 mPa.s.
- Emulsion breaker (recommended dosage: 2000 ppm relative to the oil) may effectively be used during an oil spill operation to remove or reduce water from the recovered oil/emulsion which minimizes the storage volume.

Use of chemical dispersants:

- Emulsions of Yme is found to be good dispersible with use of Dasic Slickgone NS for viscosities <1500 mPa.s (DOR 1:25) in non-breaking waves (<5 m/s wind speeds), and not/poorly dispersible for viscosities $>10\ 000$ mPa.s assuming breaking waves conditions (>5 m/s wind speeds).
- In the field, additional energy or higher DOR by repeated dispersant application may increase the dispersant effectiveness when the oil is reduced dispersible for viscosities in the range of 1500 -10 000 mPa.s.
- High pour point of surface residue may cause solidification at sea for Yme, particularly in low temperature and calm sea conditions. High pour points typically prevent or reduce the dispersant efficiency.

High-capacity water flushing (mechanical dispersion):

- Emulsification is the limiting factor for this strategy.
- The predicted film thickness >0.2 - 0.3 mm which is the estimated upper limit for effective use of water flushing and is therefore not considered as a main response option for emulsions of Yme.
- Mechanical dispersion be used as a supplementary /secondary method on e.g., peripheral areas of thin oil films of metallic/rainbow appearances in calm weather conditions.
- Mechanical dispersion can be used after dispersant treatment under calm sea conditions.

Monitoring and remote sensing:

- Monitoring and remote sensing should be used a support in a response operations for Yme.

9 Categorization of Yme to other Norwegian oil (oil map)

A semi-quantitative categorization has been developed by SINTEF to map crude oils into four main groups: Paraffinic, waxy, naphthenic, and asphaltenic oils, based on their typically physiochemical properties, as described below.

Naphthenic oils typically exhibit disrupted n-alkane (paraffins) patterns due to high degree of biodegradation of the oil in the reservoir. The content of paraffins is therefore normally low in for these oils and have low pour points (typically <-10 °C) with corresponding low wax content. Such biodegraded crude oils may have high densities and a high degree of UCM (Unresolved Complex Mixture) consisting of a wide range of complex components, such as resins and naphthenes, but this is not true for all naphthenic oils.

Paraffinic oils are often characterized by low to medium density, which reflects high content of light and saturated components, such as paraffins (n-alkanes). Paraffinic crudes differ mainly from the waxy crudes with a lower wax content (typically <6 wt. %), hence the pour point of the fresh crude is often lower compared with waxy crude oils. Paraffinic crudes exhibit medium to high evaporation loss, with rapid and high-water uptake, and normally form stable emulsions.

Asphaltenic oils have high content of heavier components reflected by high densities (typically >0.9 g/mL) and low evaporation loss. The asphaltenic crudes often exhibit low pour points (typically >-4 °C) due to the high asphaltene content (>1 wt. %) preventing wax precipitation and formation of a wax lattice structure. Compared with paraffinic and waxy crudes the asphaltenic crude oils usually have both a slower and a lower maximum water uptake. The asphaltenic crude oils form very stable, highly viscous, and persistent blackish emulsions with long expected lifetime on the sea surface. The high stability is caused by the stabilization of the polar components in the oil.

Waxy oils often exhibit high pour points due to large content of wax components (typically >6 wt. %). These oils tend to solidify producing elastic properties on the sea surface, particularly observed at low seawater temperatures. Solidification is typically pronounced if the seawater temperature is 5-15 °C below the pour point. Waxy crude oils typically exhibit a light to medium evaporative loss. The water uptake can vary extensively, whereas the emulsions can be very stable or even highly unstable depending on the content of stabilizing and polar surface-active components like the asphaltenes and resins.

The categorization of a selection of Norwegian crude oils including Yme is given in Figure 9-1.

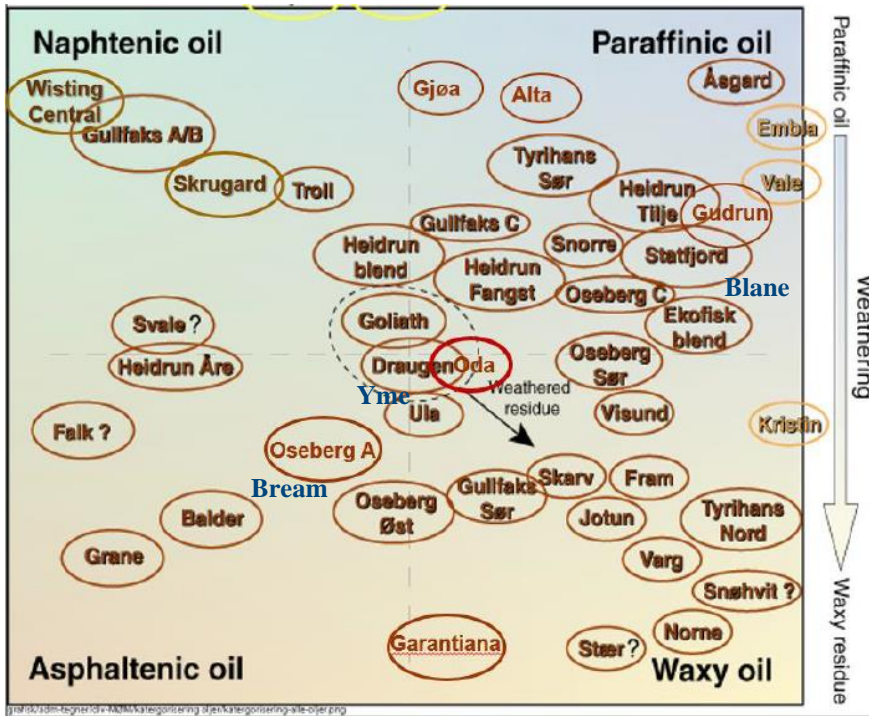

Figure 9-1: Categorization of a selection of Norwegian crude oils from previous studies.

10 References

- Bocard, C., Castaing, C. G. and Gatellier, C. 1984. "Chemical oil dispersion in trials at sea and in laboratory tests: The key role of the dilution process." Oil spill chemical dispersants: Research Experience and recommendations, ASTM STP 840. (T. E. Allen, ed.), Philadelphia, USA, pp. 125-142.
- Brakstad, O.G., and Faksnes, L.-G., (2000). Biodegradation of water-accommodated fractions and dispersed oil in the seawater column. Proceedings for the International Conference on Health, Safety and Environment in Oil and Gas Exploration and Production, Stavanger, 26-28 June 2000
- Brakstad, O-G and A.G.G Lødeng 2005. Microbial diversity during micro biodegradation of crude oil in seawater from the North Sea. *Microbial Ecology* 49:94-104
- Bridié, A.L., Wanders, T. H., Zegveld, W. V. and den Heijde, H. B., 1980. Formation, Prevention and Breaking of Seawater in Crude Oil Emulsions, Chocolate Mousse. *Marine Poll. Bull.*, vol. 11, pp. 343-348.
- Commission Internationale De L'Eclairage (CIE), No. 85, ISBN No. 3 900 734 22 4, 1989.
- Daling, P. S., Brandvik, P. J., Mackay, D. and Johansen, Ø. (1990): Characterisation of crude oils for environmental purposes. *Oil & Chemical Pollution* 7, 1990, pp. 199-224.
- Daling, P.S., Lewis, A., Sørheim, K.R., Gjesteland, I. 2017. Full-scale field testing of thin oil films from releases of light crude oil at sea. NOFO Oil-on-Water field trial in 2016. SINTEF report 2017:00030 Unrestricted. ISBN:978-82-21-40670-8.
- Hokstad, J. N., Daling, P. S., Lewis, A. and Strøm-Kristiansen, T. 1993: Methodology for testing water-in-oil emulsions and demulsifiers. Description of laboratory procedures. Proceedings Workshop on Formation and Breaking of W/O Emulsions. MSRC, Alberta June 14-15, 24 p.
- Johansen, Ø. 1991. "Numerical modelling of physical properties of weathered North Sea crude oils." DIWO-report no. 15. IKU-report 02.0786.00/15/91. Open.
- Leirvik, F., Moldestad, M. and Johansen, Ø., 2001. Kartlegging av voksrrike råoljers tilflytsevne til skimmere.
- McAuliffe, C.D. (1987). Organism exposure to volatile/soluble hydrocarbons from crude oil spills - a field and laboratory comparison. In: Proc. 1987 Oil Spill Conference. Washington, D.C., American Petroleum Institute. pp. 555-566.
- Mackay, D. and Zagorski, W. 1982. "Studies of W/o Emulsions". Report EE-34: Environment Canada, Ottawa, Ontario.
- Mackay, D. and Szeto, F. 1980. "Effectiveness of oil spill dispersants - development of a laboratory method and results for selected commercial products." Institute of Environmental Studies, University of Toronto, Publ. no. EE-16.
- McDonagh, M., Hokstad, J. N. and Nordvik, A. B. 1995. Standard procedure for viscosity measurement of water-in-oil emulsions. Marine Spill Response Corporation, Washington, D.C. MRSC Technical Report Series 95-030, 36 p.
- Moldestad, M.Ø and Schrader, T. 2002: Ringhorne, Forseti og Balder. Egenskaper og forvitring på sjøen relatert til beredskap, revidert rapport. STF66 A01137. ISBN:82-14-02296-7.
- Myrhaug, J. L., Daling, P. S. and Jensen H. V., 1999: Oppdatert forvitningsstudie for Ula råolje relater til effektivitet av Foxtail Skimmer. SINTEF rapport: STF66 F99076.
- Nordvik, A. B., Daling, P. and Engelhardt, F. R. 1992. Problems in the interpretation of spill response technology studies. In: Proceedings of the 15th AMOP Technical Seminar, June 10-12, Edmonton, Alberta, Canada, pp. 211-217.

Perry JJ (1984). Microbial metabolism of cyclic alkanes: Atlas RM (Ed) Petroleum Microbiology Macmillan Publ Co New York pp 61-98

Reed M., and C. Turner, 1991: Field Tests of Satellite tracked buoys to simulate oil drift. In Proceeding of the IOSC, SanDiego, CA. US., pp. 619 – 628

Reed, M., Turner, C. and Odulo, A. 1994. The role of wind and emulsification in modelling oil spill and surface drifter trajectories. Spill Science and Technology, Pergamon Press (2): .143-157.

Singsaas, I., Daling, P.S., Moldestad M. Ø and Jensen, H. 2000.Samle rapport: Effektivitet av Foxtail skimmer på IF-30 bunkersolje og forvitret Ula, Balder, Jotun og Troll råolje. SINTEF report. STF66 A00082

Stiver, W. and Mackay. D. 1984. Evaporation rate of spills of hydrocarbons and petroleum mixtures. Environ, Sci. Technol., vol. 18 (11), pp. 834-840.

Singsaas, I., Sørheim, K. R. and Daling, P.S., 2017. Project recommendations for response to oil spills from condensates and light crude oils. SINTEF report no.: OC2017A-205. ISBN: 9788271743208.

Strøm, T. Daling P.S., 1997. Forvitringsegenskaper på sjøen og kjemisk dispergerbarhet for Grane råolje. STF66 F98038.

Strøm, T. and Bakken, O.M., 2009. Rev condensate – Oil weathering properties related to oil spill response. SINTEF report: SINTEF A12367. ISBN: 978-82-14-04768-4.

Strøm, T., Johnsen, M. and Oltedal, T.A., 2009. Weathering properties of Blane crude oil. SINTEF report: SINTEF A12212. ISBN: 978-82-14-04767-7.

Strøm, T., and Leirvik, F., 2011. Weathering properties of Bream crude oil related to oil spill response. SINTEF report: SINTEF A19404. ISBN: 978-82-14-05137-7.

Sørheim, K.R., Daling, P.S., and F., Leirvik., 2017: Mekanisk dispergering av tynne oljefilmer. Oljevern 2015. WP048. SINTEF report: OC2017 A-125, ISBN: 978-82-7174-300-0.

Sørheim, K.R., Johnsen, M., Bakken, O.M. and Hellstrøm, K.C., 2019. Oda crude oil – Weathering properties and behaviour at sea. SINTEF report: 2019:01159, ISBN: 978-82-14-06251-9.

A The behaviour of oil on the sea surface

A.1 The chemical composition of crude oils and condensates

Crude oil is a complex mixture of thousands of chemical components. The relative compositions vary, giving rise to crude oils with different chemical and physical properties. The components found in crude oil are classified into two main chemical groups: hydrocarbons and heteroatomic organics see Figure A-1.

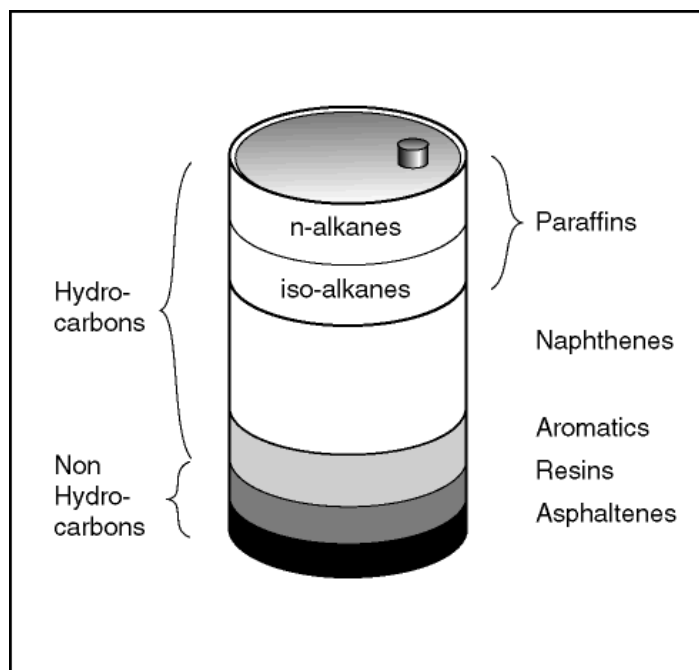

Figure A-1: The chemical composition of crude oils.

Most compounds in crude oils are hydrocarbons, which are composed of hydrogen (10-15 wt. %) and carbon (85-90 wt. %). These range from simple, volatile gases, such as methane with only one carbon atom to large, complex molecules with more than 100 carbon atoms. The hydrocarbons in crude oils include saturated and unsaturated molecules in linear, branched and cyclic configurations. Hydrocarbons are further classified into aliphatic and aromatic compounds. The two main groups of aliphatic compounds are paraffins and naphthenes.

Paraffins

Paraffins include *n*-alkane and *iso*-alkane aliphatic compounds. Waxes are an important subgroup of paraffins, containing more than 20 carbon atoms. The wax components of a crude oil will be present in a solution at elevated temperatures. At low temperatures, they may precipitate from the solution. These are principally *n*-alkanes. The wax content of crude oils can vary from 0.5 wt.% up to 40 or 50 wt.% in extreme cases, although the majority of the world's crude oils have a wax content of 2-15 wt.%.

Naphthenes

This group includes cycloalkanes containing one or more saturated rings. Each ring may have one or more paraffinic side chains, which are chiefly five- and six-membered rings.

Aromatics

Aromatics are a specific type of unsaturated cyclic hydrocarbons. Benzene, toluene and xylenes are examples of mono-ring aromatics, naphthalenes are di-ring aromatics and polycyclic aromatic hydrocarbons (PAH) contain three or more aromatic rings.

Non-hydrocarbons

In addition, hydrogen and carbon, some organic compounds in crude oils also contain small amounts of

oxygen, nitrogen or sulphur, as well as some trace metals such as vanadium and nickel. These compounds are referred to as heteroatom organic compounds because they contain a heteroatom, which is any atom that is not carbon or hydrogen. The two most important groups of heteroatom organic compounds are resins and asphaltenes.

Resins

Compared to the hydrocarbons, resins are relatively polar and often have surface-active properties. Resins have molecular weights ranging from 700-1000. Carboxylic acids (naphthenic acids), sulphoxides and phenol-like compounds can be found in this group as well.

Asphaltenes

Asphaltenes are a complex group of poorly characterized chemical compounds that consist of condensed polycyclic aromatic compounds. They are large molecules with 6-20 aromatic rings and side chains (molecular weight 1,000-10,000). Asphaltenes may be classified as "hard" or "soft" based on the method of determination. Crude oils may contain up to 6 wt. % "hard" and 10 wt. % "soft" asphaltenes (Peregrino:13.4 wt.%)

A.2 Main oil categories related to weathering

Different oil types can have extremely different compositions, which impact their physical properties and effect their behaviour after a spill at sea.

Oils that are subject to weathering can roughly be divided into 3 main categories:

- Crude oils
- Light oils
- Condensates

Crude oils contain relatively more of the heavier components than light oils or condensates. Crude oils can be weathered in the laboratory to mimic natural weathering that occurs on the sea surface. The laboratory weathered crude oil identified as 250°C+ residue, corresponds to 0.5 to 1 week after a spill at sea, and contains less than 50% of its original volume due to evaporation. The heavier components allow the formation of stable water-in-oil (w/o) emulsions, which reduces oil spreading at the sea surface. The final (terminal) film thickness of a crude oil depends on the emulsion's physical properties, and will be in the order of 1 mm.

Light oils and crude oils are not specifically differentiated in reservoir terminology. However, it is suitable to deal with the light oils as a separate category when referencing weathering properties. Light oils have a high content of low molecular weight hydrocarbons. When subjected to laboratory weathering, the 250°C+ residue of light oils may lose 50-70% of their total volume due to evaporation. In contrast to condensates, which only contain light components, light oils contain a mixture of light and heavy components. These heavy components may cause light crudes to emulsify in water, but these w/o emulsions are, however, very unstable. A light oil will spread less than a condensate, with a final film thickness of approximately 0.5 mm.

Condensates only contain low molecular weight hydrocarbons and are considered extremely volatile. Laboratory weathered condensates, such as the 250°C+ residue, typically lose more than 70% of their initial volume. Condensates do not contain components such as asphaltenes or heavier waxes and will not emulsify significant amounts of water. The spreading of condensates is relatively fast, and can result in a final film thickness of approximately 0.05 mm.

A.3 Physical properties of crude oils

The physical properties of specific oils are a result of their chemical composition. The most important physical properties in oil spill scenarios are discussed below.

Density

The density of a crude oil is dependent on the density of all its components. The density of hydrocarbons increases with increasing molecular weight. Furthermore, paraffinic oils have lower density than those containing larger amounts of high molecular weight aromatics, such as naphthenic and asphaltenic oils.

Specific gravity is defined as the oil density at 60°F (15.5°C) divided by water density at 60°F. In American literature, the density of the oil is often expressed as °API, where:

$$^{\circ}\text{API} = \frac{141.5}{\text{Specific gravity}} - 131.5$$

In the present study, the density of the oil is presented as specific gravity.

The density of fresh crude oils normally lies in the range 0.78 to 0.95 g/mL (50 to 10 °API).

A.3.1 Rheological properties

The viscosity of crude oils expresses its resistance to flow and is of special interest when pumping oil. **Absolute viscosity** (also known as dynamic viscosity) is a measure of internal resistance. In the SI system, absolute viscosity has units of N s/m², Pa s or kg/(m s), where 1 Pa s = 1 N s/m² = 1 kg/(m s). Absolute viscosity can also be expressed in the metric CGS (centimeter-gram-second) system as g/(cm s), dyne s/cm² or Poise, where 1 Poise = 1 dyne s/cm² = 1 g/(cm s) = 1/10 Pa s = 1/10 N s/m². The industry often uses centipoise, as the *Poise* is normally too large, 1 Poise = 100 cP and 1 cP = 0.001 N s/m². The viscosity of fresh crude oils can vary from less than 1 to more than 2000 mPa·s (cP) at ambient sea temperature. In comparison, water has an “absolute” viscosity of 1 cP and syrup's is 120 000 cP at 20°C.

Kinematic viscosity is absolute viscosity divided by density. 1 centistoke (cSt) = 1 cP / density. Because the density of weathered oils and emulsion are typically 0.9 – 1 g/mL, the units cSt and cP will often have similar values. Viscosity is temperature dependent. For liquids, the viscosity decreases with increasing temperatures. Viscous and waxy crude oils can exhibit non-Newtonian behaviour (viscosity varies with shear rate), especially close to, or below, their pour point. Water-in-oil (w/o) emulsions exhibit this non-Newtonian behaviour with shear thinning. In an oil spill situation, an emulsion may be liquid under turbulent conditions at sea, but can become much more viscous, or even semi-solid in calmer water conditions, or on beaches. Thus, the measurements of the viscosity of w/o-emulsions must be carried out under strictly controlled conditions (defined shear rates and thermal and mechanical history of the sample). At SINTEF, a shear rate of 10 s⁻¹ is routinely used for expressing viscosity data on w/o-emulsions.

The viscosity of an oil increases with evaporation since the heavier, more viscous components remain in the residue (Mackay et al., 1982). The difference in viscosity for crude oils is approximately 3 to 2000 mPa·s for fresh crude oils and several hundred/thousand mPa·s for their residues. Water-in-oil (w/o) emulsions are generally more viscous than the parent crude oil; this is illustrated in Figure A-2.

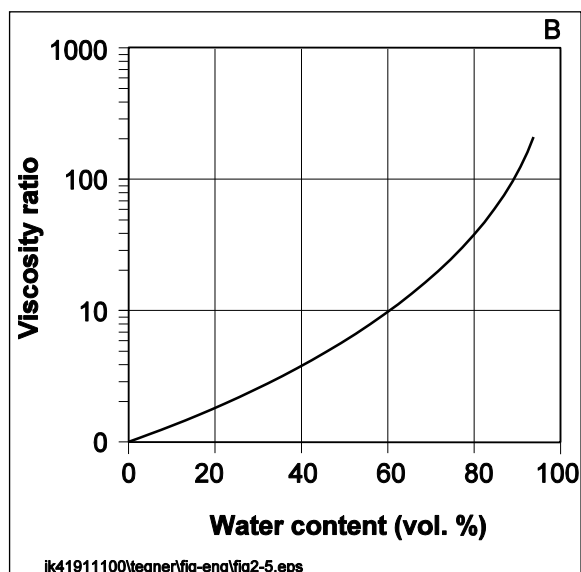

Figure A-2: Example of viscosity ratio as a function of water content.

A.3.2 Pour point

The temperature at which oil ceases to flow when cooled without disturbance under standardized conditions in the laboratory is defined as the oil's pour point (ASTM-D97). The method accurately determines the temperature at which the oil become semi-solid under the specified laboratory conditions. Due to the movement at the sea surface, the oil may remain a liquid at sea at temperatures as low as 5 to 15 °C lower than the pour point of the oil. The pour point of oil with high wax content will increase dramatically with evaporation as the lower weight molecules, which contribute to keeping the wax in solution, evaporate. The pour point for oils with high wax contents can reach 30 °C, while low viscous naphthenic oils may have pour points as low as -40 °C. In an oil spill clean-up situation, the pour point provides essential information for when determining the efficiency of various skimmers, pumping rates and the use of dispersing agents.

A.3.3 Distillation curve

The distillation curve, which is obtained by measuring the vapour temperature as a function of the amount of oil distilled, shows the relative distribution of volatile and heavier components in the oil. The boiling point of a chemical component depends on its vapour pressure, which is a function of its molecular weight and chemical structure. Low molecular weight oil components have a higher vapour pressure, thus lower boiling points than higher molecular weight components of a similar type. Aromatic compounds boil at a higher temperature than paraffinic compounds of the same molecular weight, and *iso*-alkanes boil at a lower temperature than the equivalent *n*-alkanes. Hence, the distillation curve is an indicator of the relative amount of different chemical components, principally as a function of molecular weight, but also as determined by the chemical composition.

A.3.4 Flash point

The flash point is the lowest temperature at which the gas or vapour generated by the heating of oil will form an ignitable mixture in air. The flash point depends on the proportion of low molecular weight components. Fresh crude oils normally have a low flash point (from -40 °C to 30 °C). From a safety point of view, flash points are most significant at, or slightly above, the maximum temperature that may be encountered in storage or transport. The flash point is an approximate indicator of the relative fire and explosion hazard of oil.

Rule of thumb:

In the presence of an oil slick at sea, a fire and/or explosion hazard exists when the oil's flash point is close to or lower than the sea temperature.

Natural weathering processes such as evaporation and emulsion formation contribute to reducing the potential hazard by increasing the flash point. Thus, it will be a relatively short fire and/or explosion danger in the initial stages of oil spill. In the laboratory, the flash point is measured in a closed system with the components in the oil and gas equilibrated. In the field, however, the weather situation will influence the flammability of the air above the slick. The gas concentration will be high just above the oil film in calm weather and high temperatures, whereas the concentration will be low in cold and windy weather due to dilution and transport and a lower degree of evaporation.

A.4 The behaviour of crude oil spilled at sea

This chapter gives a general description of the main weathering processes when oil is spilled at sea. There are many natural processes that take place that change the volume and chemical properties of the oil. These natural processes are evaporation, water-in-oil (w/o) emulsification, oil-in-water (o/w) dispersion, spreading, sedimentation, oxidation and biodegradation. A common term for all these natural processes is weathering. The relative contribution of each process varies during the duration of the spill. The weathering of oil depends on the oil type (chemical and physical properties), the weather conditions (wind, waves, temperature and sunlight) and the properties of the seawater (salinity, temperature, bacterial flora, etc.). Figure A-3 illustrates the various weathering processes, and Figure A-4 shows their relative importance over time.

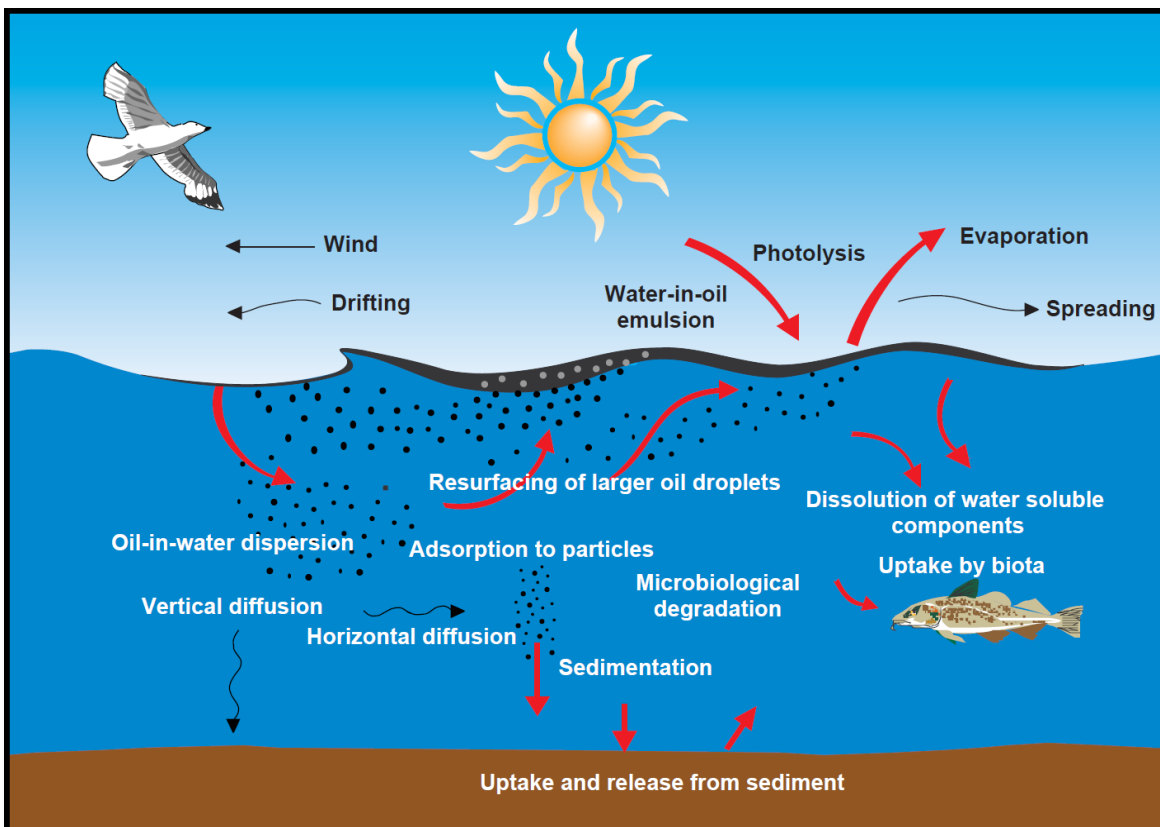

Figure A-3: Illustrating the weathering processes that take place when oil is spilled on the sea surface.

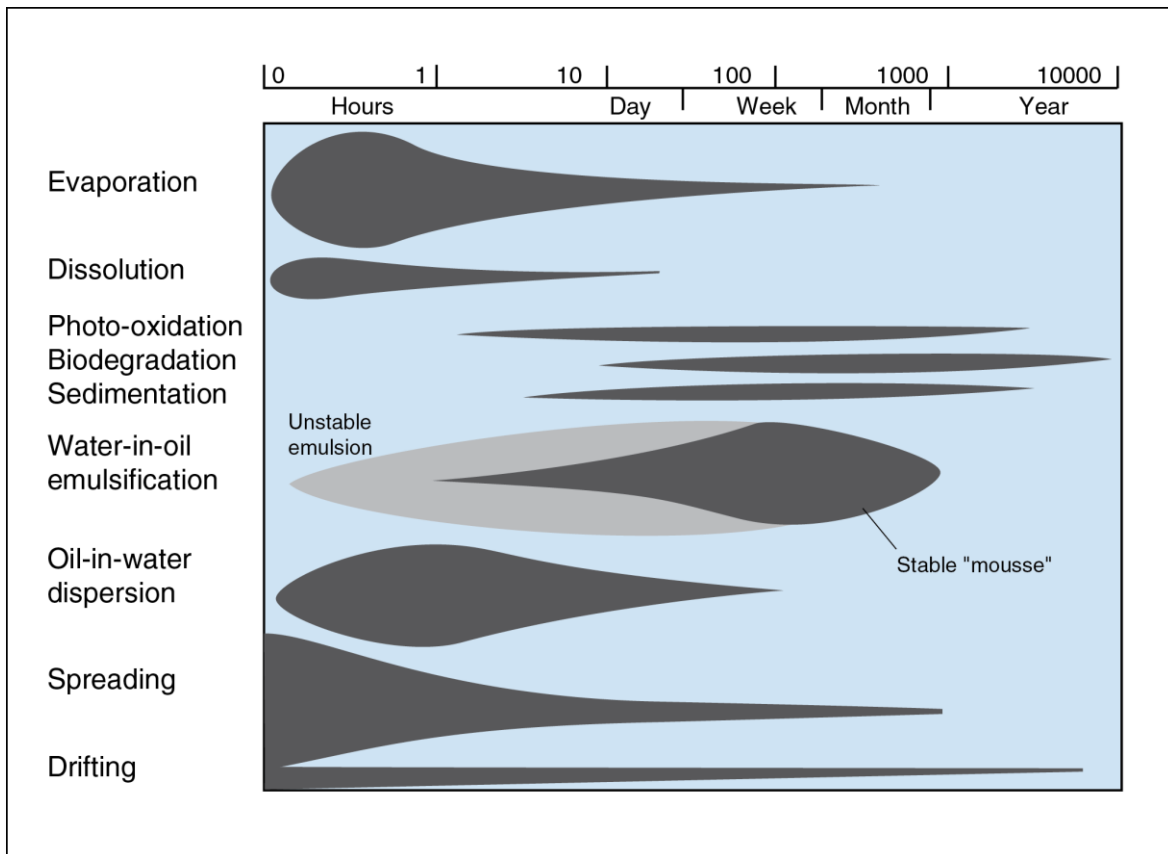

Figure A-4: Weathering processes' relative importance over time. Note: logarithmic scale.

A.4.1 Evaporation

Evaporation is one of the natural processes that support the removal of spilled oil from the sea surface. The evaporation process starts immediately after the oil is spilled, and the evaporation rate decreases exponentially throughout the duration of the oil spill. The evaporated amount depends on the chemical composition of the oil in addition to the prevailing weather conditions, sea temperature and oil film thickness.

The rate of evaporation varies for different oil types. Light refinery products (e.g. gasoline and kerosene) may completely evaporate after a few hours/days on the sea surface. Condensates and lighter crude oils can lose 50% or more of their original volume during the first days after an oil spill. The most significant difference caused by evaporation is the loss of volatile and semi-volatile compounds, which increases the relative amounts of higher molecular weight compounds. With evaporations, the chemical and physical properties of the remaining oil will change. The density, viscosity, pour point and wax and asphaltene content, will all increase with increased evaporation.

A.4.2 Spreading

Oil spilled at sea will spread on the sea surface. Spreading is often the dominant process in the initial stages of an oil spill and decreases as the viscosity and density of the remaining oil increases. The spreading process is also reduced if the oil's pour point is 5-15°C below the sea temperature.

Oceanographic conditions (e.g. wind, waves and currents) affect the spreading process. The oil slick will be broken into windrows aligned in the direction of the wind, see Figure A-5. The thickness of the oil slick varies, often differing by a factor of several thousand. Experience has shown that most of the total oil slick area consists of a thin film (<1 µm oil thickness) that only contains 10% of the oil volume. Most of the oil volume

(~90%) is in small patches of w/o emulsions with a film thickness of 1 to 5 mm, which often constitutes less than 10% of the total oil slick area.

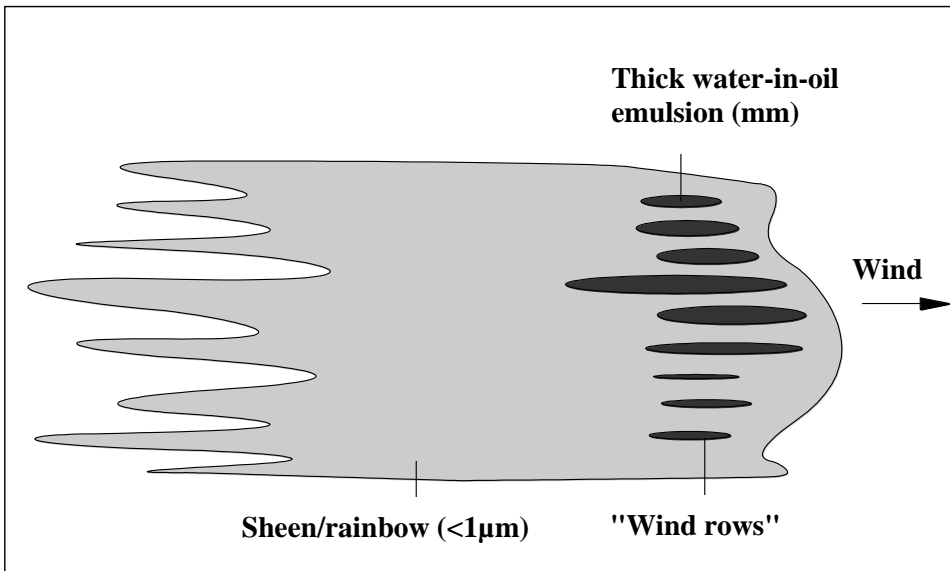

Figure A-5: The spreading of oil spilled on the sea surface and the distribution within the oil slick.

A.4.3 Drift of an oil slick

The oil slick will drift as the weathering processes continue. The wind and current conditions cause the oil slick to drift, as illustrated in Figure A-6. Waves and wind create a current in the mass of water which amounts to approximately 3% of the wind speed at the sea surface. The influence of the wind decreases rapidly with the depth of the water below the surface. At 1 to 2 meters the current reduces to approximately 1% of the wind speed. This means that oil on the surface of the open sea, will move faster than the water below (e.g. Reed and Turner, 1991; Reed et al., 1994). In the absence of wind, the oil drift is governed by the prevailing (background) current.

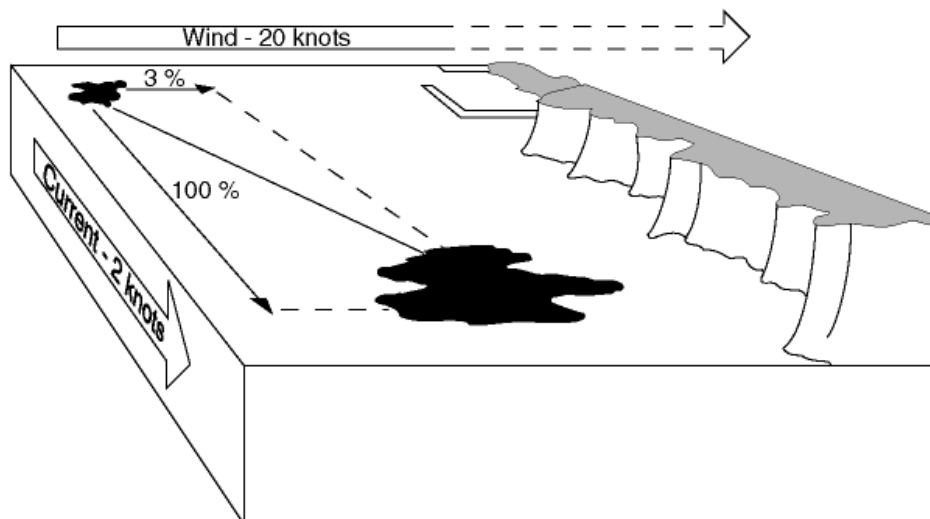

Figure A-6: An illustration showing how wind and current can influence the drifting of an oil slick.

A.4.4 Water-in-oil (w/o) emulsion

The formation of water-in-oil emulsions significantly affects the behaviour and clean-up of oil spilled at sea. Because of emulsification, the total emulsion volume may increase to as much as six times the original spilled oil volume depending on the properties of the oil. The formation of w/o emulsions also contributes to keeping oil on the sea surface. A w/o emulsion normally has a higher viscosity than the parent crude oil, so the emulsification process will therefore retard/delay evaporation and the natural dispersion process. The minimum criterion for the formation of w/o emulsions is the presence of breaking waves (i.e. a wind speed of >5 m/s). Nonetheless, a slow water uptake can also take place during calmer weather. Figure A-7 shows how wind speed influences the w/o formation rate.

Surface active compounds present in crude oil will promote the formation of w/o emulsions and contribute to stabilizing the emulsion. These components contain both hydrophilic and hydrophobic groups. The maximum water uptake will vary for different crude oils. Tests performed at SINTEF have revealed that the maximum water uptake is independent of the prevailing weather conditions if the lower energy barrier for the formation of w/o emulsions is exceeded. The rate, however, depends highly on the weather conditions. In the laboratory, the $t_{1/2}$ -value is determined, which is the time in hours it takes before the oil has emulsified half of its maximum water content. The w/o emulsion formation rate depends on the oil's chemical composition, which varies for different oil types.

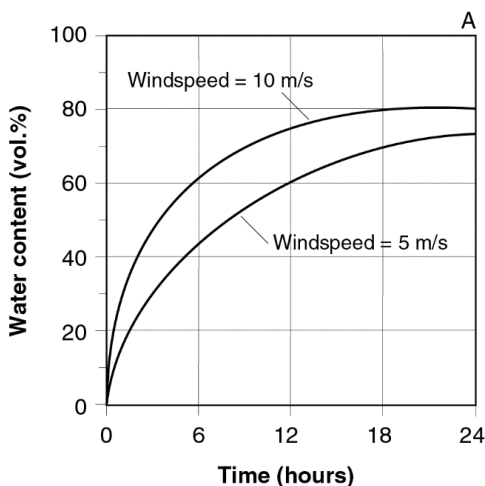

Figure A-7: Example of how weather conditions influence the w/o emulsion formation for typical oils

The stability of the w/o emulsion depends on the water droplet size, since not all water droplets in the emulsion are stable. Larger water droplets may be reduced in size by the flexing, stretching and compressing motion of the slick due to wave action, whereas the largest droplets may coalesce and be squeezed out of the w/o emulsion. After a certain period, the emulsion may only contain small water droplets with diameters of 1 to 10 μm , yielding a more stable emulsion.

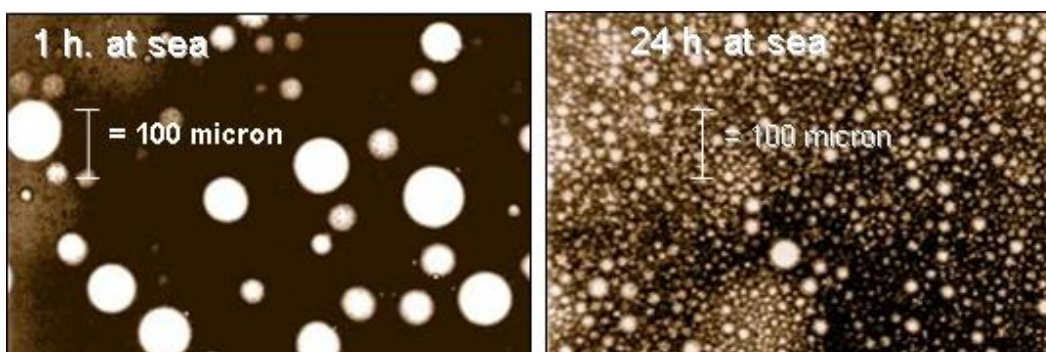

Figure A-8: Microscope pictures of w/o emulsion after (A) 1 h. and (B) 24 h. in a rotating cylinder

Thus, the formation of emulsions is the result of water retention by oil as an effect of both viscous and interfacial forces. The interfacial forces are the most important, and asphaltenes are largely responsible for this. Resins are similar compounds to asphaltenes and can stabilize an emulsion, but not to the same extent.

Resins and asphaltenes have both hydrophobic and hydrophilic properties and will concentrate at the interface between the water and oil, thereby forming a layer that stabilizes the water droplets. The hydrophobic properties can lead to the concentration of wax along the water droplets, which further stabilizes the interfacial “skin” layer. The interfacial layer between the oil and water forms a physical barrier that hinders the coalescence of the water droplets and will stabilize the w/o emulsion. The stabilization of the water droplets by asphaltenes and wax is shown in Figure A-9.

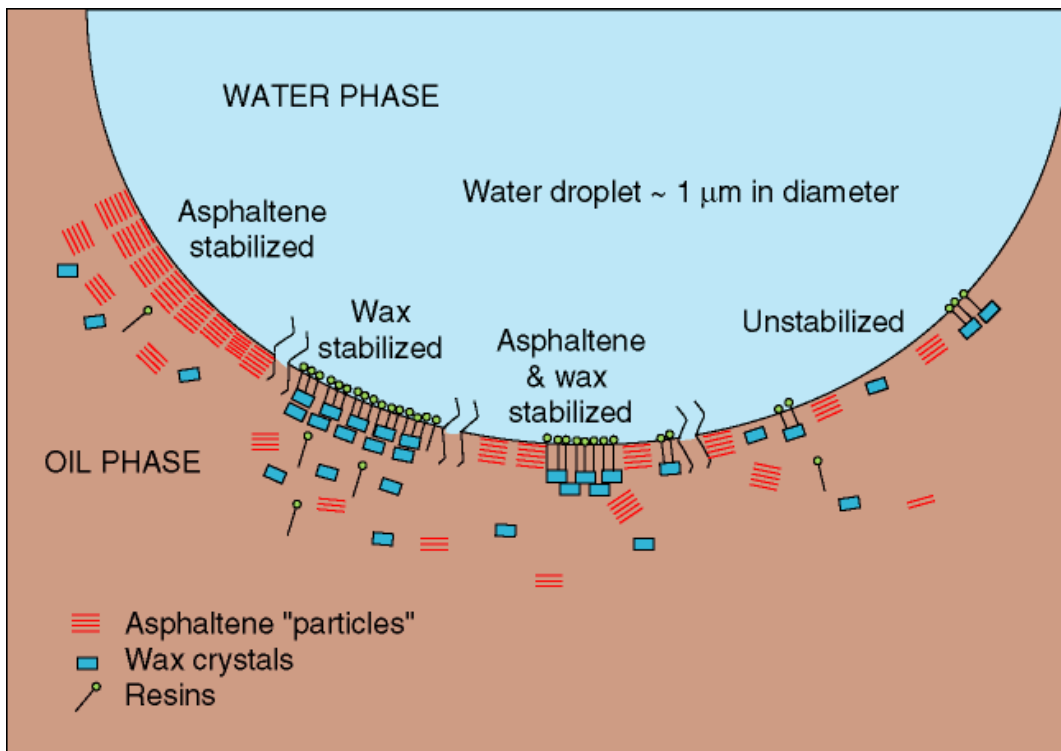

Figure A-9: Interfacial layer stabilized by wax and asphaltenes in w/o emulsion.

Oils that contain large amounts of wax and small amounts of asphaltenes can form w/o emulsions stabilized by a continuous phase’s rheological strength (viscosity and elasticity) due to wax structure formed by precipitated wax. Wax stabilized emulsions are characterized by large water droplets and are fairly stable when stored, although they may break down when stress is applied and/or when the emulsion is heated to, e.g. 40-50 °C.

Crude oil and sea water interfacial tension (IFT) plays a key role in the process of oil droplet formation. The need to understand and control droplet formation in dispersant system is extremely important. Addition of dispersants reduces the interfacial tension between oil and water that subsequently promotes the formation of a larger number of small oil droplets when surface waves entrain oil into the water column. These small, submerged oil droplets are then subject to transport by subsurface currents and other natural removal processes, such as dissolution, volatilization from the water surface, biodegradation, and sedimentation resulting from interactions with suspended particulate material.

A.4.5 Oil-in-water (o/w) dispersion

Natural oil-in-water (o/w) dispersion will take place if there is sufficient energy on the sea surface, i.e. if there are breaking waves present. The waves will break the slick into small oil droplets (~1 µm - 1 mm in diameter), which are then mixed into the upper water column. The largest oil droplets will resurface and form a thin oil film (typically <50 µm). This thin oil film will be rapidly dispersed again by breaking waves as smaller droplets into the water column and will be available for rapid biodegradation.

The natural dispersion rate depends highly on oil type and can be one of the main processes that determine the lifetime of an oil slick on the sea surface. Natural o/w dispersion will gradually decrease with time since the evaporation of the lighter compounds will increase the viscosity of the remaining oil.

The purpose of applying chemical dispersing agents is to increase, or enhance, the natural dispersion rate. Dispersants reduce the interfacial tension between water and oil and thus promote natural o/w dispersion. When effective chemical dispersion is achieved, small oil droplets are formed, with typical diameters ranging from 5 to 100 µm. These are retained in the upper layers of the water column by the prevailing turbulence of wave action.

A.4.6 Water solubility

The water solubility of saturated hydrocarbons is generally very low, while lower molecular weight aromatic compounds are water-soluble to some extent; particularly aromatics, such as BTEX, 2-ring PAH and paraffin's up to C₇) have a potential to be dissolved in the water column (McAuliffe, 1987). Within the various types of hydrocarbons, the water solubility decreases from aromatics to naphthenes and from *iso*-alkanes to *n*-alkanes. In each series, the water solubility decreases with *increasing* molecular weight.

Evaporation and the release of oil components into the water mass are competitive processes since most of the water-soluble components are also volatile. The evaporation process is approximately 10 to 100 times faster than the release in the water column. The concentration of soluble oil components into the water column during an oil spill is quite low (< 1 mg/L), while the dissolution of oil components into the water column does not contribute to removing the oil from the sea surface. However, the water-soluble fraction is of great interest since it has a high bioavailability and thus the potential to cause acute toxic effects on marine organisms.

A.4.7 Photo-oxidation

Under the influence of sunlight, some of the oil components will slowly oxidize to resins and finally asphaltenes. The photo-oxidized components will stabilize the w/o emulsions and influence the oil's persistence on the sea surface. After a long period of weathering at sea, tar balls (mainly consisting of asphaltenes) may be formed. These tar balls break down very slowly, both at sea and on beaches.

A.4.8 Biodegradation

Seawater contains an abundance of microorganisms that can break down all types of oil components. Various microorganisms prefer specific oil components as their energy source. Bacteria prefer to degrade oil in contact with water and the rate of biodegradation depends on the water/oil interface area. The interface area increases as the oil is spread over the sea surface in a thin layer or by chemical or natural dispersion of oil into the water column. Important factors influencing the biodegradation rate are temperature, the concentration of available nutrients (i.e., nitrogen and phosphorus), oxygen, oil type and the degree of weathering. Low molecular compounds are degraded more rapidly than the high molecular weight/heavier compounds in the oil, thus giving the following order for biodegradation: straight-chain *n*-alkanes > branched *iso*-alkanes > cyclic alkanes > cyclic naphthenes > aromatics > resins > asphaltenes (Perry, 1984).

At sea, the formation of oil droplets by natural or chemical enhanced dispersion will increase the biodegradation rate in the water mass by 10 to >100 times compared to surface oil due to increased water/oil interfacial area. When immobilised on hydrophobic synthetic fabrics, *n*-alkanes biodegraded within 2-4 weeks

at North Sea conditions (13°C; Brakstad and Lødeng, 2005). Some small PAHs dissolved in water can be degraded within a few days (Brakstad and Faksness, 2000), but high molecular-weight oil compounds associated with particulate oil biodegrade more slowly and some very high molecular-weight compounds (equivalent to the heavy residues in crude oil that are used to make bitumen) may not biodegrade to any significant degree.

A.4.9 Sedimentation

Crude oil and oil residues rarely sink into the water mass since there are few oils that have a density higher than water, even after extreme weathering. Oil can sink by sticking to materials present in the water mass. W/o emulsions that have a higher density value (e.g., emulsified bunker fuel oils) can more easily stick to a material, particularly if coming to the shore, and can sink to the bottom if washed out again from the shore. In connection to sub-sea blowout at the sea bottom, it is assumed that some of the oil droplets generated in the plume may adsorb to suspended particles or encounter with the seabed sediment. This can cause some sedimentation of oil droplets to the seabed near the release. It is assumed that sub-sea dispersant treatment will reduce the potential for such sedimentation, due to lower adsorption /stickiness to sediment particles.

A.4.10 Deep water releases

Size distribution of the oil droplets formed during a subsurface release strongly influences the subsequent fate of the oil in the environment. Large droplets (typically larger than 5 mm) reach the surface after a couple of hours rise time from a depth of approximately 1000 m, while smaller droplets (down to 0.5 mm) may rise for up to a day before they will come to the surface. Fine droplets (below 100 microns) may stay in the water for weeks or even month before they eventually reach the surface. However, factors like vertical turbulence mixing in the water column, density stratification and cross flows will contribute to keep such fine small droplets submerged for even prolonged periods (Johansen et al., 2003). In case of deep-water releases, large droplets (mm range) will usually rise to the surface and form an oil layer with sufficient thickness to emulsify (form water-in-oil emulsions). This is usually caused by loss of buoyancy and more horizontal entrainment of the gas/oil/water plume due to dissolution of gas, possible hydrate formation, cross currents and density layers. However, large droplets (mm range) will leave the entrained plume and rise to the surface, illustrated in Figure A-10. This was observed both during the “DeepSpill” experiments in 2000 (Figure A-11) and the DWH oil spill in 2010 (Figure A-12). This emulsification will be dependent on oil properties and environmental conditions, such as temperature and sea state.

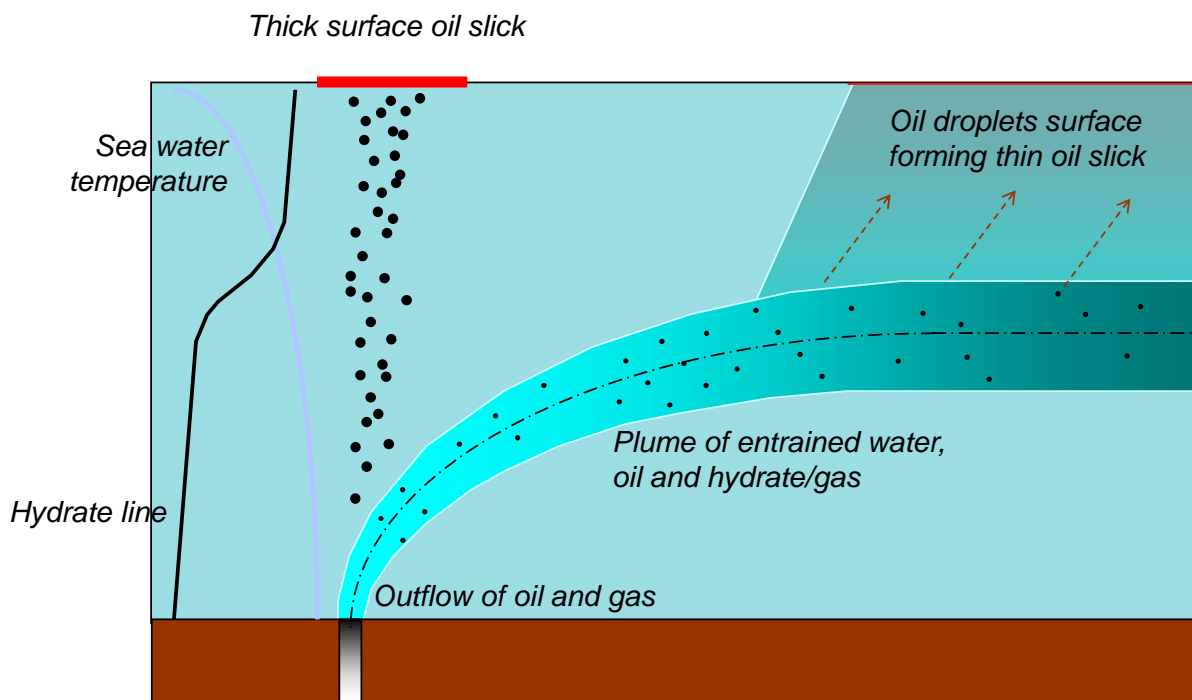

Figure A-10: Illustration of possible creation of thick surface oil slick (> 200 μm) from deep water release of oil.

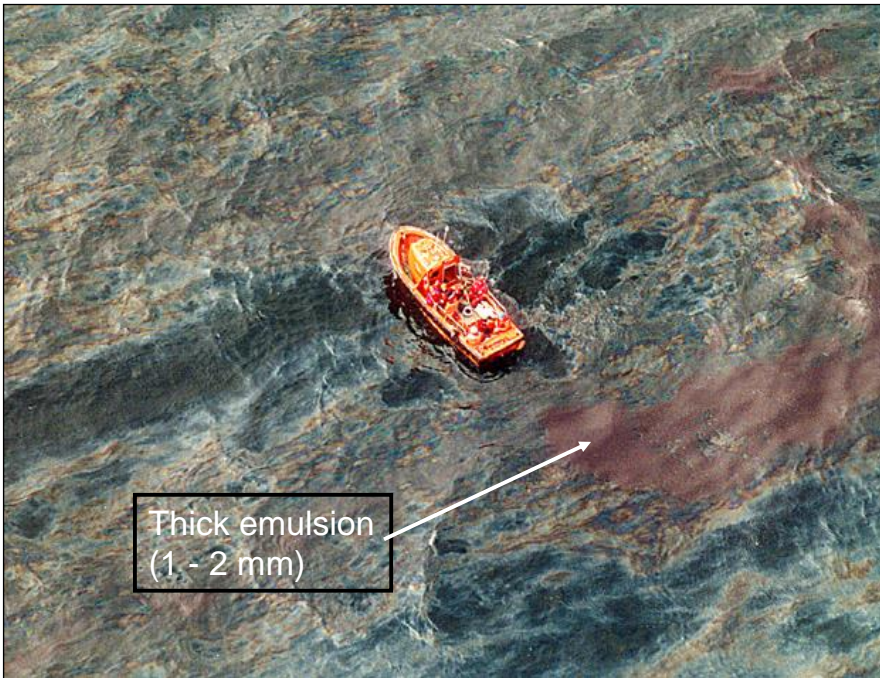

Figure A-11: Surface oil slick (initial thickness > 200 μm) from the experimental deep-water release DeepSpill in 2000. Surface oil is emulsifying similar to an oil slick from a surface batch release (from Leirvik et al., 2011).

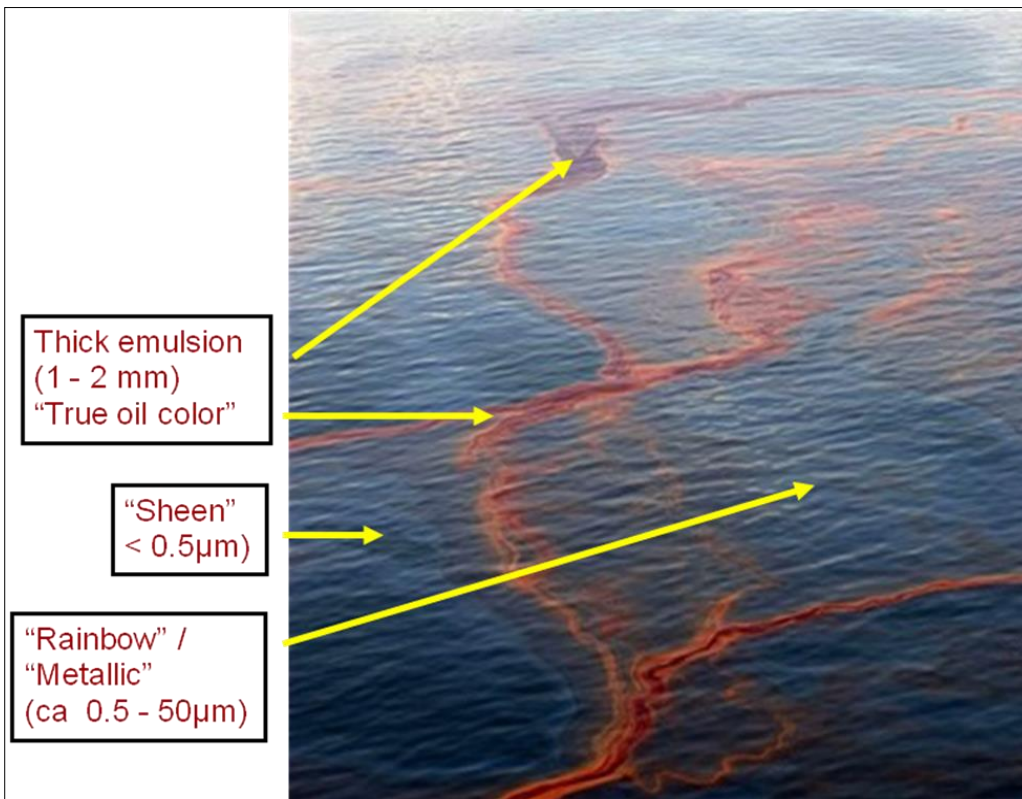

Figure A-12: Surface oil slick (initial thickness > 200 μm) from the DWH deep water release. Surface oil is emulsifying similar to an oil slick from a surface batch release.

A.4.11 Shallow releases

In case of a sub-surface release of oil and gas in shallower water (<500 meter) the buoyancy of the rising water/gas/oil plume is usually sufficient to reach the surface. The gas will be released to the atmosphere, while the large volumes of water will set up a horizontal current that will create a wide and thin surface oil slick (see Figure A-13, Figure A-14 and Rye et al, 1997). This surface oil slick will in many cases be too thin to emulsify (< 200 microns) and evaporation and natural dispersion will be the predominant weathering processes.

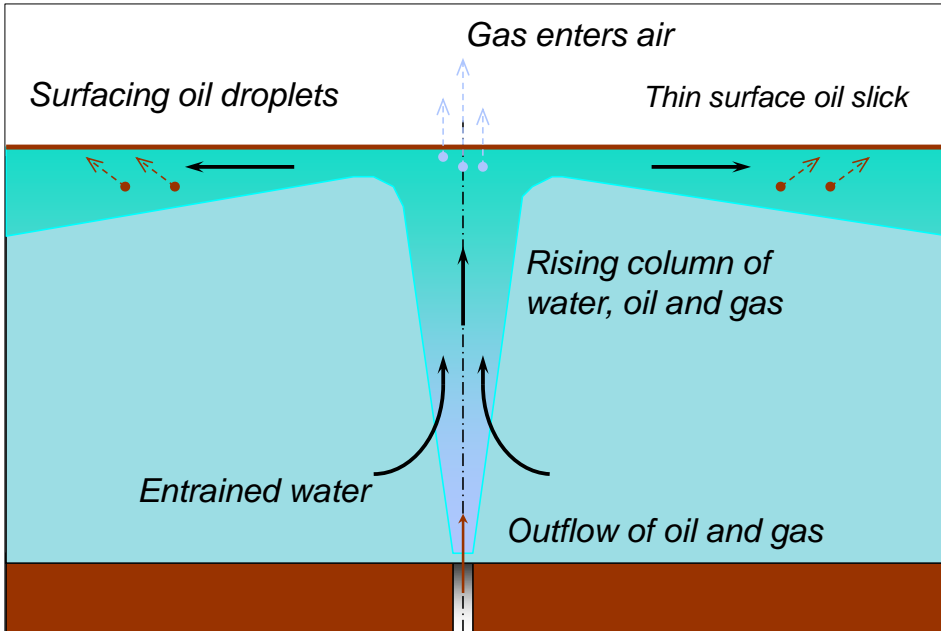

Figure A-13 Illustration of possible creation of thin surface oil slick (< 200 μm) from a shallow subsurface release (<500 m).

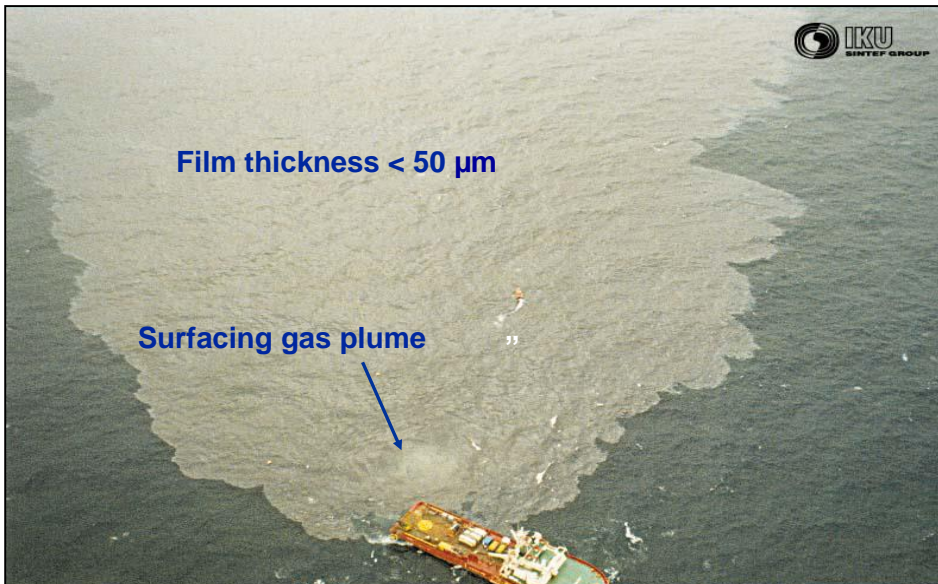

Figure A-14: Surface oil slick (< 50 μm) from experimental subsurface release at 106 m in 1996. The surface oil didn't emulsify and had a very limited lifetime (hours) due to the low film thickness and high rate of natural dispersion (even at < 10 m/s wind).

B Experimental setup and HSE

B.1 Oil sample and test temperature

SINTEF Ocean received Yme on 22.02.2023. Sampling date: 11.02.2023

The oil sample were registered in LIMS and given SINTEF ID: 2023-2621. Figure B-1 shows Yme as received.

The weathering dispersibility study (bench--scale) were performed at 5 and 13 °C, and the meso-scale flume testing was conducted at 13 °C as supplementary study. The oil sample was pre-handled, heated to about 50 °C and homogenised before distillation and further analysis.

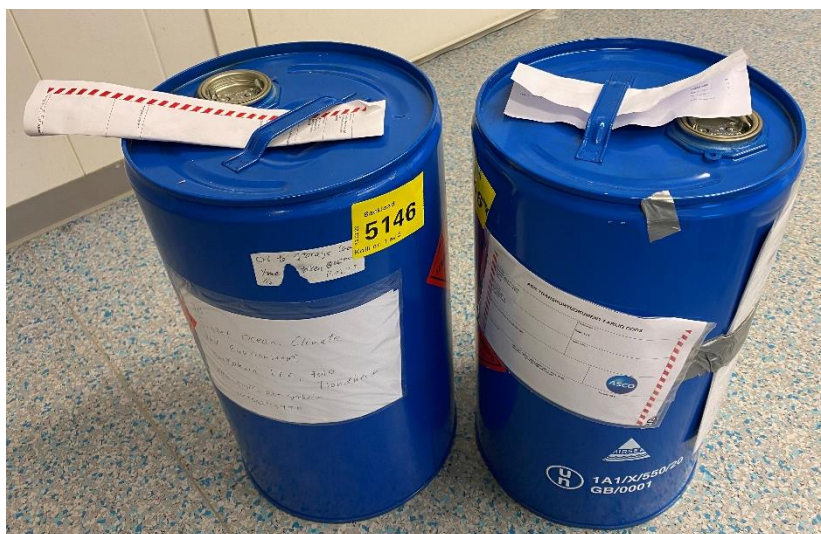

Figure B-1: Picture of Yme as received.

B.2 Water content

Water content in the oil phase was quantified by use Karl Fisher titration for HSE and risk assessment prior to the topping/distillation step to simulate evaporative loss at sea by topping/distillation.

B.3 Small-scale laboratory testing

To isolate and map the various weathering processes at sea, the crude oil was exposed to a systematic, stepwise procedure developed at SINTEF (Daling et al., 1990). The general procedure is illustrated in Figure B-2.

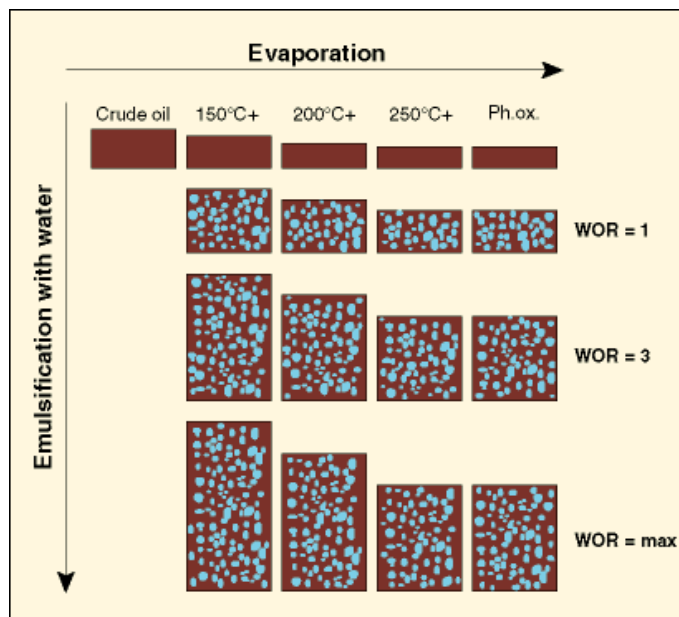

WOR: Water to Oil Ratio

WOR=1: 50 vol.% water

WOR=3: 75 vol.% water

WOR=max: the maximum water content

Figure B-2: Small-scale laboratory weathering flow chart of oil.

B.4 Evaporation

The evaporation procedure used is described in Stiver and Mackay (1984). Evaporation of the lighter compounds from the fresh oil was carried out as a simple one-step distillation to vapour temperatures of 150 °C, 200 °C and 250 °C, which resulted in oil residues with an evaporation loss corresponding to approximately 0.5-1-hour, 0.5-1 day and 0.5-1 week of weathering on the sea surface. These residues are referred to as 150°C+, 200°C+ and 250°C+, respectively.

B.5 Physical and chemical analysis

The viscosity, density, pour point and flashpoint of the fresh and water-free residues was analysed. In addition, wax content and "hard" asphaltenes was measured for the 250°C+ residue. Viscosity for all the w/o emulsions was determined. The analytical methods used are given in Table B-1 and Table B-2.

Table B-1: Analytical methods used to determine the physical properties.

Physical property	Analytical method	Instrument
Viscosity	McDonagh et al, 1995	Physica MCR 300
Density	ASTM method D4052-81	Anton Paar, DMA 4500
Pour point	ASTM method D97	-
Flash point	ASTM D 56-82	Pensky-Martens, PMP1, SUR

Table B-2: Analytical methods used to determine the chemical properties.

Chemical property	Analytical method
Wax content	Bridiè et al, 1980
"Hard" asphaltene	IP 143/90

Chemical characterization by GC-FID and GC-MS

- The distribution of hydrocarbons (nC_5 - nC_{40}) was analysed using a Gas Chromatograph coupled with a Flame Ionisation Detector (GC-FID). The Gas Chromatograph used was an Agilent 6890N with a 30m DB1 column.
- The analysis and quantification of PAHs, phenols, and alkylated phenols (C_0 - C_4) were completed using an Agilent 6890 Gas Chromatograph coupled with 5973 MSD detector (GC-MS) operating in SIM mode (Selected Ion Monitoring)
- The volatile components were in the range of nC_5 - nC_{10} and were quantified by use of PT-GC-MS (Purge and Trap Gas chromatograph Mass Spectrometer operating in full-scan mode and using a modified version of the EPA 8260 analysis method).

B.6 Emulsification properties

The w/o emulsification studies were performed by the rotating cylinders method developed by Mackay and Zagorski (1982), which is described in detail by Hokstad et al., 1993. The method includes the measuring of the following parameters:

- Relative water uptake (kinetics)
- Maximum water uptake
- Stability of the emulsion
- Effectiveness of emulsion breaker (Alcopol 60%)

The principle of the rotating cylinders method is illustrated in Figure B-3. Oil (30 mL) and seawater (300 mL) are mixed and rotated with a rotation speed of 30 rpm in separating funnels (0.5 L). The emulsification kinetics is mapped by measuring the water content at fixed rotation times. The maximum water content is determined after 24 hours of rotation.

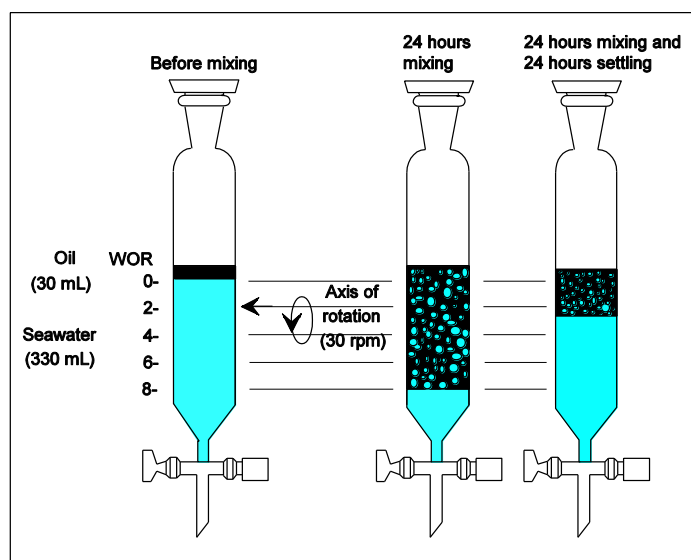

Figure B-3: Principle of the rotating cylinder method

B.7 Chemical dispersibility testing

There are several different tests for evaluating the effect of chemical dispersants. The energy input will differ in the different tests, and the obtained efficiency will be representative of different wave energies. At SINTEF, the IFP and MNS test is used in dispersibility testing. IFP and MNS test apparatus are shown in Figure B-4.

IFP (Institute Français du Pétrole test, Bocard *et al.*, 1984) is a low energy test estimated to represent low wave energies (2-5 m/s wind speed). A surge beating up and down in the test vessel at a given frequency, gives energy input to the seawater column. The water column is continuously diluted, which gives a more realistic approach to field conditions, compared to other tests.

MNS (Mackay-Nadeau-Szeto test, Mackay and Szeto, 1980) is estimated to correspond to a medium to high sea state condition. The energy input in this system, applied by streaming air across the oil/water surface, produce a circular wave motion. The sample of the oily water is taken under dynamic conditions after a mixing period of 5 min.

Both IFP and MNS test apparatus is shown in Figure B-4.

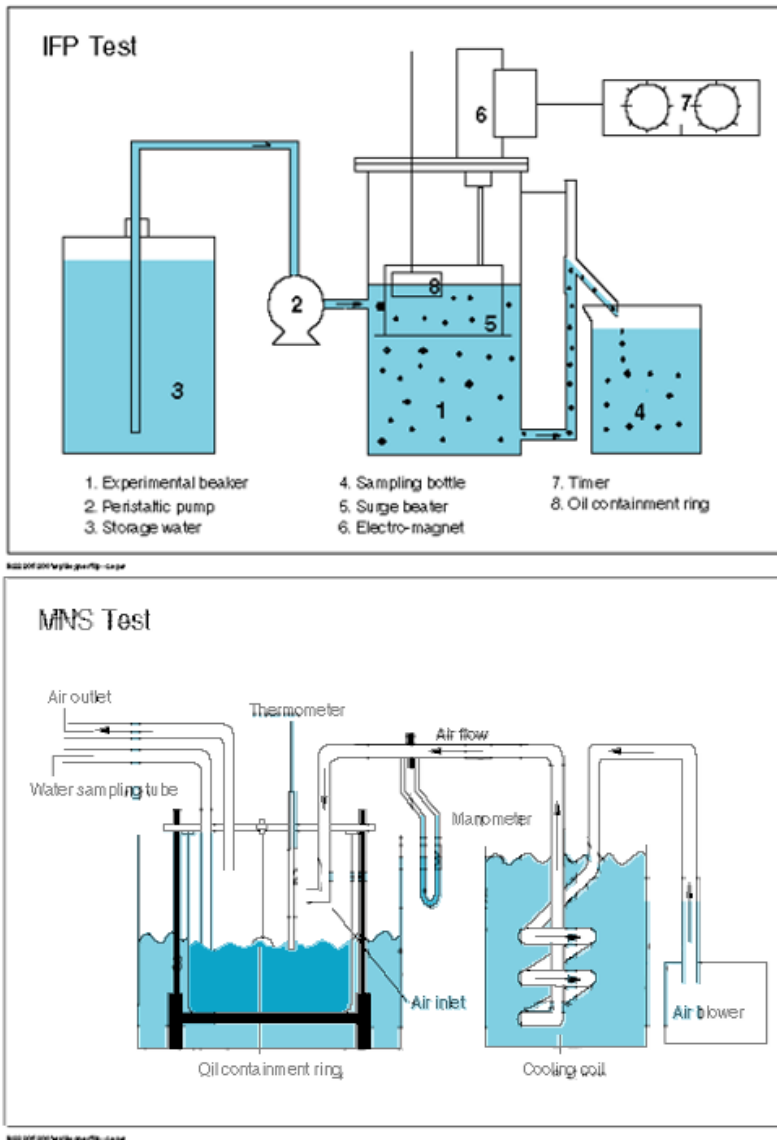

Figure B-4: IFP and MNS test apparatus for effectiveness testing of dispersants.

B.8 Meso-scale laboratory testing

In an oil spill situation at sea, the weathering processes will occur simultaneously and affect each other. In the small-scale laboratory testing, these processes are studied individually. By using the meso-scale flume, the weathering and effect of dispersants can be studied under more realistic conditions, having the weathering processes to occur at the same time, giving a better image of the behaviour of the oil at sea.

A meso-scale flume basin (Singsaas et al., 1993), located at SINTEF's Sealab, is routinely used to simultaneously study the weathering processes under controlled conditions. The meso-scale flume basin was

rebuilt in 2006, having state of the art instrumentation. A schematic drawing of the flume is given in Figure B-4.

Approximately 5m³ seawater circulates in the 10 metres long flume. The flume basin is stored in a temperature-controlled room (0-20 °C). Two fans are placed in a covered wind tunnel, controlling the wind speed. The fans are calibrated to simulate an evaporation rate corresponding to a wind speed of 5-10 m/s on the sea surface.

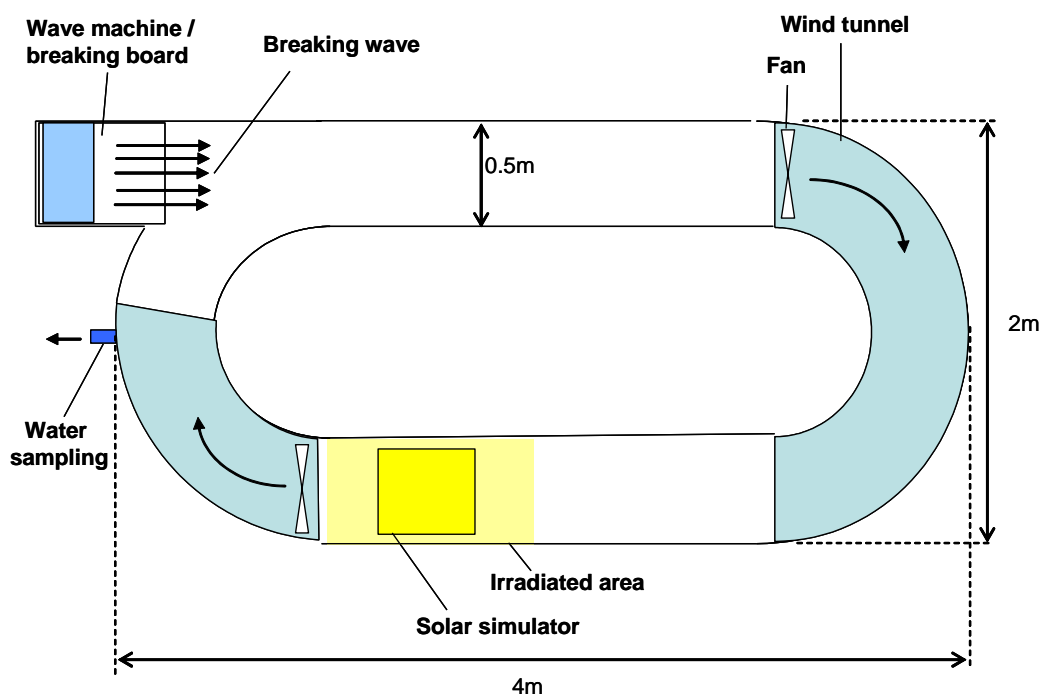

Figure B-4: Schematic drawing of the meso-scale flume.

In a meso-scale flume study, the relevant oil is carefully released on the seawater surface under calm conditions. The wave machine and fans are then started, and the experiment begins. A reference water sample is collected before the beginning of the experiment. Both surface oil/emulsion and water column are sampled frequently the first 6 hours, then after 12 hours and subsequently every day. After three days (72 hour) dispersant is applied to the surface emulsion. Water samples are then collected more frequently. The addition of dispersant may be repeated once or twice, in which case water samples are also collected.

Analysis of surface oil/emulsion

Samples of the surface oil/emulsion are collected using an aluminum tray and transferred to a 0.5 L separating funnel. The free water is removed after settling for 10 minutes in the climate room. The oil phase is further handled for an analysis of its physical properties. The physical properties determined for all surface oil samples during the experiments are:

- Viscosity
- Water content
- Density
- Evaporative loss
- Emulsion stability

Analysis of water samples

Water samples are analysed for oil concentration in the water column (droplets and dissolved components). The samples are taken at a depth of 50 cm through a tap in the basin wall into a Pyrex glass bottle (1 L). The sampled water is acidified with 10% hydrochloride, HCl (pH < 2) upon storage. The sampling position is shown

in Figure B-4. Samples are then extracted by liquid-liquid extraction with dichloromethane (DCM) and quantified by Ultraviolet (UV) spectrophotometry.

Solar simulation in the meso-scale flume

Sunlight is simulated with a solar simulator from Gmbh Steuernagel. The solar lamp (4 KW) emits a wavelength spectrum calibrated to fit natural sunlight at high noon and in the absence of clouds. Figure B-5 shows the measured spectrum from the solar simulator compared to one of the most widely used standard spectra for solar irradiance (CIE publication 85, 1989).

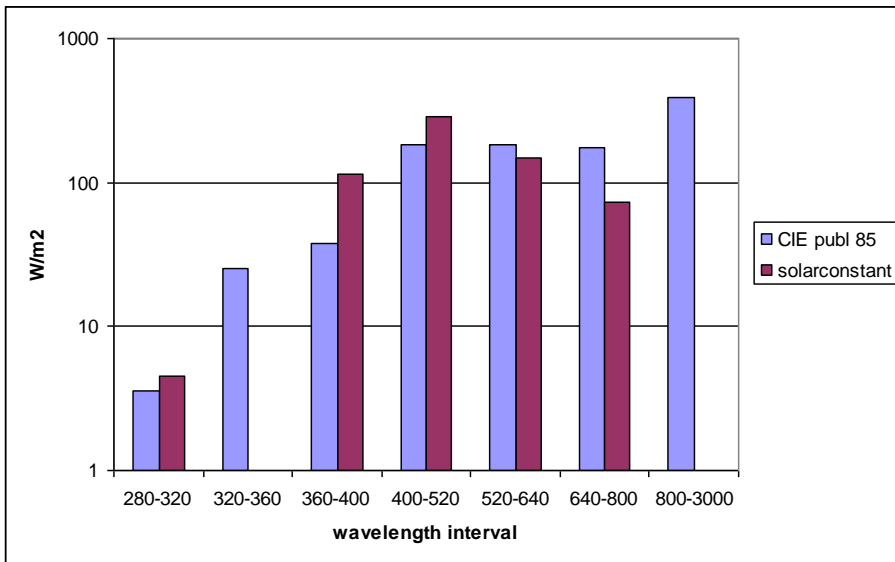

Figure B-5: Measured wavelength compared to standard spectrum suggested in CIE publication 85.

The exact exposure of solar irradiance on the oil in the meso-scale flume is somewhat difficult to calculate. Since the oil is moving, it will only be within the irradiated area periodically. The exposure will be highly dependent on the distribution of the oil in the flume and the thickness of the emulsion on the water surface. In Figure B-6 an estimated irradiation per day, using the solar simulator, is compared with the average irradiation per day for selected Norwegian cities.

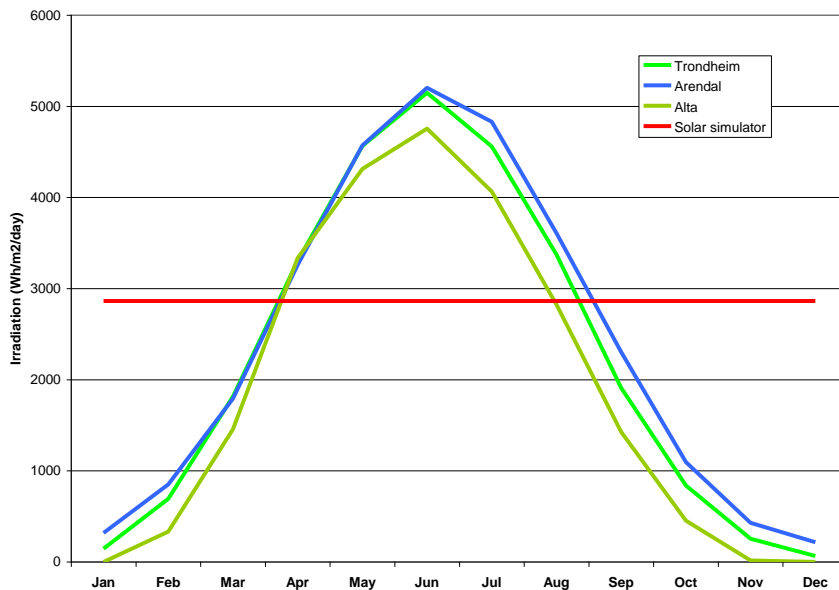

Figure B-6: Daily Irradiation for some Norwegian cities throughout the year compared with the estimated daily irradiation in the meso-scale flume.

C Input data to SINTEF Oil Weathering Model (OWM)

The laboratory data used as input to the SINTEF OWM for Yme are given from Table C-1 to Table C-5. Two separate profiles were made for Yme: The oil weathering predictions at 5 were based on laboratory data from testing at 5 °C, while predictions at 15 °C were based on the laboratory data from testing at 13 °C. The profiles are named “Yme 2023, 5°C” and “Yme 2023, 13°C”.

Table C-1: Physical and chemical properties for Yme at 5 °C, used as input in the oil weathering model.

Properties of fresh oil	Yme
Density (g/mL)	0.842
Pour point (°C)	9
Reference temperature (°C)	5
Viscosity at ref. temp. (mPa·s = cP) *	89
Flash point (°C)	-
Asphaltenes (wt. %)	0.54
Wax Content (wt. %)	3.38
Dispersible for visc. <	1500
Not dispersible for visc. >	10000

* Measured at shear rate 100 s⁻¹: Not analyzed /no data

Table C-2: Physical and chemical properties for Yme at 13 °C, used as input in the oil weathering model.

Properties of fresh oil	Yme
Density (g/mL)	0.842
Pour point (°C)	9
Reference temperature (°C)	13
Viscosity at ref. temp. (mPa·s = cP) *	47
Flash point (°C)	-
Asphaltenes (wt. %)	0.54
Wax Content (wt. %)	3.38
Dispersible for visc. <	1500
Not dispersible for visc. >	10000

Table C-3: True boiling point (TBP) curve of Yme. Source of TBP: Crude Assay report no: 23-002423-0-RDAM, dated 10.03.2023, from Intertek Caleb Brett. Selected datapoints from original TBP.

Temp. °C	Yme vol. %	Yme, wt%
15	1.31	0.89
65	5.33	4.00
95	10.43	8.35
135	18.79	15.80
175	26.47	22.88
232	36.78	32.75
265	43.70	39.60
320	54.85	50.73
369	64.51	60.60
450	77.37	74.20
509	86.16	83.72
565	91.03	89.07

Table C-4: Lab weathering data for Yme, 5 °C.

Properties	Fresh	150°C+	200°C+	250°C+
Boiling Point Temp. (°C)		200.6	259.55	302.05
Vol. Topped (%)	0	17.9	28.9	37.8
Weight Residue (wt. %)	100	84.6	74.5	66.1
Density (g/mL)	0.84247	0.86806	0.88273	0.8936
Pour point (°C)	9	24	27	30
Flash Point (°C)		41	79.5	108.5
Viscosity of water-free residue (mPa·s = cP)*	89	304	803	1634
Viscosity of 50% emulsion (mPa·s = cP)**		1069	2401	13482
Viscosity of 75% emulsion (mPa·s = cP)**		3185	8899	
Viscosity of max water (mPa·s = cP)**		7185	12238	22607
Max. water cont. (vol. %)		84.8	79.3	71.7
(T1/2) Halftime for water uptake (hrs)		0.41	0.47	0.65
Stability ratio		0.94	0.96	1

* Measured at shear rate 100 s⁻¹

** Measured at shear rate 10 s⁻¹

Empty: No data

Table C-5: Lab weathering data for Yme, 13 °C

Properties	Fresh	150°C+	200°C+	250°C+
Boiling Point Temp. (°C)		200.6	259.55	302.05
Vol. Topped (%)	0	17.9	28.9	37.8
Weight Residue (wt. %)	100	84.6	74.5	66.1
Density (g/mL)	0.84247	0.86806	0.88273	0.8936
Pour point (°C)	9	24	27	30
Flash Point (°C)		41	79.5	108.5
Viscosity of water-free residue (mPa·s = cP)*	47	118	280	577
Viscosity of 50% emulsion (mPa·s = cP)**		874	1484	4910
Viscosity of 75% emulsion (mPa·s = cP)**		1766	4507	9975
Viscosity of max water (mPa·s = cP)**		2412	9199	13405
Max. water cont. (vol. %)		90.9	85	78.6
(T1/2) Halftime for water uptake (hrs)		0.26	0.26	0.25
Stability ratio		0.99	0.90	0.98

* Measured at shear rate 100 s⁻¹

** Measured at shear rate 10 s⁻¹

Empty: No data

D Chemical characterization – OSCAR composition file

The method for generating oil profile as input for OSCAR is based on the quantification of semi-volatile organic hydrocarbons (SVOC) and volatile organic hydrocarbons (VOC) by GC-MS. The composition is divided into individual pseudo-component groups (OSCAR groups) representing the oil based on the TBP (True Boiling Point) and GC-MS analysis.

Table D-1: Chemical characterization of Yme (fresh oil) from GC-MS analysis and TBP oil fraction

Wt. %	Group no.	Composition
1.800	1	C1-C4 gasses (dissolved in oil)
1.900	2	C5-saturates (n-/iso-/cyclo)
2.154	3	C6-saturates (n-/iso-/cyclo)
0.146	4	Benzene
3.200	5	C7-saturates (n-/iso-/cyclo)
0.375	6	C1-Benzene (toluene) et. B
6.925	7	C8-saturates (n-/iso-/cyclo)
0.543	8	C2-Benzene (xylenes; using O-xylene)
4.509	9	C9-saturates (n-/iso-/cyclo)
0.448	10	C3-Benzene
3.400	11	C10-saturates (n-/iso-/cyclo)
0.048	12	C4 and C4 Benzenes
5.149	13	C11-C12 (total sat + aro)
0.003	14	Phenols (C0-C4 alkylated)
0.162	15	Naphthalenes 1 (C0-C1-alkylated)
7.838	16	C13-C14 (total sat + aro)
0.000	17	Unresolved Chromatographic Materials (UCM: C10 to C36)
0.244	18	Naphthalenes 2 (C2-C3-alkylated)
5.856	19	C15-C16 (total sat + aro)
0.217	20	PAH 1 (Medium soluble polyaromatic hydrocarbons (3 rings-non-alkylated;<4 rings)
5.783	21	C17-C18 (total sat + aro)
6.400	22	C19-C20 (total sat + aro)
8.500	23	C21-C25 (total sat + aro)
0.300	24	PAH 2 (Low soluble polyaromatic hydrocarbons (3 rings-alkylated; 4-5+ rings)
34.100	25	C25+ (total)

The SINTEF OSCAR model is a 3-dimensional Oil Spill Contingency And Response model system that calculates and records the distribution (as mass and concentrations) of contaminants on the water surface, on shore, in the water column and in sediments. The model allows multiple release sites, each with a specified beginning and end to the release. This allows time-variable releases at a given location, as well as throughout the study area. The model computes surface spreading, slick transport, entrainment into the water column, evaporation, emulsification and shore interactions to determine oil drift and fate at the surface. In the water column, horizontal and vertical transport by currents, dissolution, adsorption, settling and degradation are simulated. By modelling the fate of individual pseudo-components, changes in the oil composition due to evaporation, dissolution and degradation are accounted for.