

**SINTEF Building and Infrastructure**

Øyvind Bjøntegaard (Norwegian Public Roads Administration),  
Synnøve A. Myren (Norwegian Public Roads Administration) and  
Ola Skjølsvold

# Round Robin Test program on Energy Absorption Capacity of Round Panels according to Norwegian Concrete Associations Publication no 7:2011

COIN Project report 48 – 2013



SINTEF Building and Infrastructure

Øyvind Bjøntegaard (Norwegian Public Roads Administration),  
Synnøve A. Myren (Norwegian Public Roads Administration) and  
Ola Skjølsvold

# **Round Robin Test program on Energy Absorption Capacity of Round Panels according to Norwegian Concrete Associations Publication no 7:2011**

FA 2 Competitive constructions

SP 2.2 Ductile high tensile strength concrete

COIN Project report 48 – 2013

COIN Project report no 48

Øyvind Bjøntegaard (Norwegian Public Roads Administration), Synnøve A. Myren (Norwegian Public Roads Administration) and Olav Skjølsvold

**Round Robin Test program on Energy Absorption Capacity of Round Panels according to Norwegian Concrete Associations Publication no 7:2011**

FA 2 Competitive constructions

SP 2.2 Ductile high tensile strength concrete

Keywords:

Fibre reinforced concrete, round panel tests, energy absorption capacity, Round-Robin test programme

Project no.: 102000442-4

ISSN 1891-1978 (online)

ISBN 978-82-536-1349-9 (pdf)

© Copyright SINTEF Building and Infrastructure 2013

The material in this publication is covered by the provisions of the Norwegian Copyright Act. Without any special agreement with SINTEF Building and Infrastructure, any copying and making available of the material is only allowed to the extent that this is permitted by law or allowed through an agreement with Kopinor, the Reproduction Rights Organisation for Norway. Any use contrary to legislation or an agreement may lead to a liability for damages and confiscation, and may be punished by fines or imprisonment.

Address: Forskningsveien 3 B  
POBox 124 Blindern  
N-0314 OSLO

Tel: +47 22 96 55 55

Fax: +47 22 69 94 38 and 22 96 55 08

[www.sintef.no/byggforsk](http://www.sintef.no/byggforsk)

[www.coinweb.no](http://www.coinweb.no)

**Cooperation partners / Consortium Concrete Innovation Centre (COIN)**

**Kværner Engineering**

Contact: Jan-Diederik Advocaat

Email: Jan-Diederik.Advocaat@kvaerner.com

Tel: +47 67595050

**Mapei AS**

Contact: Trond Hagerud

Email: trond.hagerud@mapei.no

Tel: +47 69972000

**Norwegian Public Roads Administration**

Contact: Kjersti K. Dunham

Email: kjersti.kvalheim.dunham@vegvesen.no

Tel: +47 22073940

**Saint Gobain Weber**

Contact: Geir Norden

Email: geir.norden@saint-gobain.com

Tel: +47 22887700

**SINTEF Building and Infrastructure**

Contact: Tor Arne Hammer

Email: tor.hammer@sintef.no

Tel: +47 73596856

**Unicon AS**

Contact: Stein Tosterud

Email: stto@unicon.no

Tel: +47 22309035

**Norcem AS**

Contact: Terje Rønning

Email: terje.ronning@norcem.no

Tel: +47 35572000

**Skanska Norge AS**

Contact: Sverre Smeplass

Email: sverre.smeplass@skanska.no

Tel: +47 40013660

**Veidekke Entreprenør ASA**

Contact: Christine Hauck

Email: christine.hauck@veidekke.no

Tel: +47 21055000

**NTNU**

Contact: Terje Kanstad

Email: terje.kanstad@ntnu.no

Tel: +47 73594700

## Preface

---

This study has been carried out within COIN - Concrete Innovation Centre - one of presently 14 Centres for Research based Innovation (CRI), which is an initiative by the Research Council of Norway. The main objective for the CRIs is to enhance the capability of the business sector to innovate by focusing on long-term research based on forging close alliances between research-intensive enterprises and prominent research groups.

The vision of COIN is creation of more attractive concrete buildings and constructions. Attractiveness implies aesthetics, functionality, sustainability, energy efficiency, indoor climate, industrialized construction, improved work environment, and cost efficiency during the whole service life. The primary goal is to fulfil this vision by bringing the development a major leap forward by more fundamental understanding of the mechanisms in order to develop advanced materials, efficient construction techniques and new design concepts combined with more environmentally friendly material production.

The corporate partners are leading multinational companies in the cement and building industry and the aim of COIN is to increase their value creation and strengthen their research activities in Norway. Our over-all ambition is to establish COIN as the display window for concrete innovation in Europe.

About 25 researchers from SINTEF (host), the Norwegian University of Science and Technology - NTNU (research partner) and industry partners, 15 - 20 PhD-students, 5 - 10 MSc-students every year and a number of international guest researchers, work on presently 5 projects:

- Advanced cementing materials and admixtures
- Improved construction techniques
- Innovative construction concepts
- Operational service life design
- Energy efficiency and comfort of concrete structures

COIN has presently a budget of NOK 200 mill over 8 years (from 2007), and is financed by the Research Council of Norway (approx. 40 %), industrial partners (approx 45 %) and by SINTEF Building and Infrastructure and NTNU (in all approx 15 %).

For more information, see [www.coinweb.no](http://www.coinweb.no)

Tor Arne Hammer  
Centre Manager

## Summary

---

A Round-Robin test program (inter-laboratory study) on energy absorption capacity of round panels is presented. The panels were tested according to the procedure described in Norwegian Concrete Associations Publication no. 7, 2011 (NB 7:2011). Four laboratories participated in the program:

- SINTEF Building and Infrastructure, Trondheim (SINTEF-T)
- SINTEF Building and Infrastructure, Oslo (SINTEF-O)
- Mannvit Testing and Research Lab, Island (MANNVIT)
- Norwegian Public Roads Administration, Sentrallaboratoriet, Oslo (NPRA)

20 steel fibre reinforced round panels were cast from one single batch of concrete at SINTEF-T. The panels were distributed to the three other laboratories, and each laboratory received and tested 5 panels. Testing age for the panels (diameter 600 mm, thickness 100 mm) was 92 days after batching. Standard 28-days compressive cube strength of the tested  $m=0.45$  steel fibre reinforced concrete was 57.8 MPa.

The fibre distribution through the batched 680 litres volume was measured to be very satisfactory; probably related to the fact that the fibres were added directly into the mixer and with thorough mixing after the addition.

The within-lab (repeatability) COV for energy absorption capacity from five panels at each lab varied from 5.5% to 12.2%, and overall average within-lab COV among the four labs was 9.0%. The between-lab variation among the average energy absorption capacity results from each lab was low; the COV was only 4.5%. An estimate on the between-lab reproducibility corresponds to a COV of 10.1 %. These COV-values are in the same range as previous results reported in the literature and must therefore be considered normal and satisfactory.

Among the four labs the average energy absorption capacity varied from 824 Joule to 918 Joule. A typical result from each lab can be expected to be represented by the average result  $\pm$  the standard deviation (i.e. a confidence interval of 68%). In such case the results overlap, leading to the simple conclusion that the differences among the labs are insignificant.

A panel test is normally reported as the average result of three panels, which is in accordance with NB 7:2011. The present Round-Robin involved five panels at each lab. It appears therefore relevant to consider the ten different combinations of three and three panels that are possible among the five panels. For example, it is notable that for the lab with the highest overall average result (among five panels) all ten average results from the combinations of three and three panels are larger than all the ten combinations from the lab with the lowest overall average result (among five panels). It can be suspected that some of the differences in average results that are seen are of more general character rather than coincidental, but the answer to this could only be found by further Round-Robin tests.

## Table of contents

---

<b>PREFACE</b> .....	<b>3</b>
<b>SUMMARY</b> .....	<b>4</b>
<b>TABLE OF CONTENTS</b> .....	<b>5</b>
<b>1 INTRODUCTION</b> .....	<b>6</b>
<b>2 CONCRETE MIXING, CASTING, FRESH CONCRETE, STRENGTH</b> .....	<b>6</b>
2.1 MIXING, FRESH CONCRETE, CASTING AND NUMBERING OF PANELS .....	6
2.2 FIBRE CONTENT AND FIBRE DISTRIBUTION .....	8
2.3 28-DAYS COMPRESSIVE STRENGTH .....	9
<b>3 PACKING, SHIPMENT AND DISTRIBUTION OF PANELS</b> .....	<b>9</b>
<b>4 TEST AND ANALYSING PROCEDURE - ENERGY ABSORPTION CAPACITY</b> .....	<b>10</b>
<b>5 ROUND PANEL TESTS - RESULTS AND DISCUSSION</b> .....	<b>12</b>
5.1 GENERAL .....	12
5.2 MEASUREMENTS OF PANEL THICKNESS AND DIAMETER .....	13
5.3 ENERGY ABSORPTION CAPACITY RESULTS, WITHIN-LAB AND BETWEEN-LAB VARIATION.....	13
5.3.1 <i>Introduction to the evaluation</i> .....	13
5.3.2 <i>Within-lab variation (repeatability)</i> .....	13
5.3.3 <i>Between-lab variation (reproducibility)</i> .....	16
5.3.4 <i>All 20 panels evaluated as one group</i> .....	17
5.4 SINGLE ROUND PANEL TEST RESULTS; LAB-BY-LAB .....	19
5.4.1 <i>Results Lab1</i> .....	19
5.4.2 <i>Results Lab2</i> .....	20
5.4.3 <i>Results Lab3</i> .....	21
5.4.4 <i>Results Lab4</i> .....	22
<b>6 CONCLUSION</b> .....	<b>23</b>
<b>REFERENCES</b> .....	<b>24</b>
APPENDIX 1 Measurements of panel thickness and diameter .....	25
APPENDIX 2 Raw data records from the panel tests .....	27
APPENDIX 3 Pictures of the panels after testing.....	29
APPENDIX 4 Outprint from all panel tests .....	30

## 1 Introduction

---

The report presents a Round-Robin test program involving four laboratories (labs). Energy absorption capacity of fibre reinforced round panels have been tested according to the new test and analysing procedure described in Norwegian Concrete Associations Publication no. 7, 2011 (NB 7:2011) [1]. The objective was to gain experience with the new method and to get documentation on variability.

Participating labs were:

- SINTEF Building and Infrastructure, Trondheim (SINTEF-T)
- SINTEF Building and Infrastructure, Oslo (SINTEF-O)
- Mannvit Testing and Research Lab, Island (MANNVIT)
- Norwegian Public Roads Administration, Sentral lab, Oslo (NPRA).

This is a study on the method as such; the panels, totally 20, were therefore cast (and not sprayed) from one single concrete batch at SINTEF-T in order to minimize variability during sampling. Each lab tested five panels.

Within-lab testing variation (repeatability) and between-lab testing variation (reproducibility) have been evaluated and compared to results from the literature. The statistical evaluation has been done with a look to some standards treating accuracy of measurement methods, ISO5725-1:1994 [2], ISO 5725-2 [3] and NS-EN 932-6 [4].

## 2 Concrete mixing, casting, fresh concrete, strength

---

### 2.1 Mixing, fresh concrete, casting and numbering of panels

The used steel fibre reinforced concrete recipe is a quite typical one for Norwegian sprayed concrete applications. To minimize variability during sampling and to avoid batch-to-batch variation all specimens were cast traditionally (and not sprayed) from one single batch. Mixing and casting was done at SINTEF-T. 20 round panel moulds (inner dimensions: Ø600 mm and thickness 100 mm) were collected from SINTEF-T and SINTEF-O.

A 30 litre trial batch was mixed first to find adequate amount of superplastiziser and slump level. After that a batch of 680 litres was made for the Round-Robin test program. The nominal concrete mix has a w/(c+2s)-ratio of 0.45, 4% silica fume and 0.4 vol% (30.4 kg) steel fibre. Final adjusted concrete mix proportions (adjusted for actual air content, density, amount of plastiziser) are given in Table 1, also including fresh concrete measurements.

Standard SINTEF mixing procedure was used for all conventional constituents. Finally the steel fibres were added gradually during mixing. When all fibres were in the mix, the mixing was continued for several minutes more to ensure good homogenization.

20 panels were cast with use of a concrete scip and a wheelbarrow. One by one panel was cast, screened and numbered according to its place in the casting sequence. After finishing all panels they were covered with a plastic sheet, see Figure 1. During the casting of panels, three fresh concretes samples of 8 litres each were collected for control of fibre content and fibre distribution, see Figure 2. Three 100 mm cubes were also cast for standard testing of 28-days compressive strength.

**Table 1 Concrete mix proportions and fresh concrete measurements**

	Type	Kg/m <sup>3</sup>
Cement	Norcem Standard FA – CEM II/A-V 42,5 R	500
Microsilika	Elkem	20
Water	(w/(c+2s)=0.454)	245.4
Sand 0-8 mm	Årdal	1478
Superplastiziser	Dynamon SX-N	4,4
Steel fibre	Dramix 65/35	31
	Measured air content	3,5%
	Measured density	2280 kg/m <sup>3</sup>
	Measured slump	230 mm
	Fibre content and fibre distribution	See next chapter



A) 680 litres Round Robin batch



B) Gradually adding fibres while mixing



C) Casting with scip and wheelbarrow



D) Screening of test panels



E) Numbering of panels and plastic sheet cover for curing until de-moulding

**Figure 1 Pictures taken during mixing and casting (A - E)**



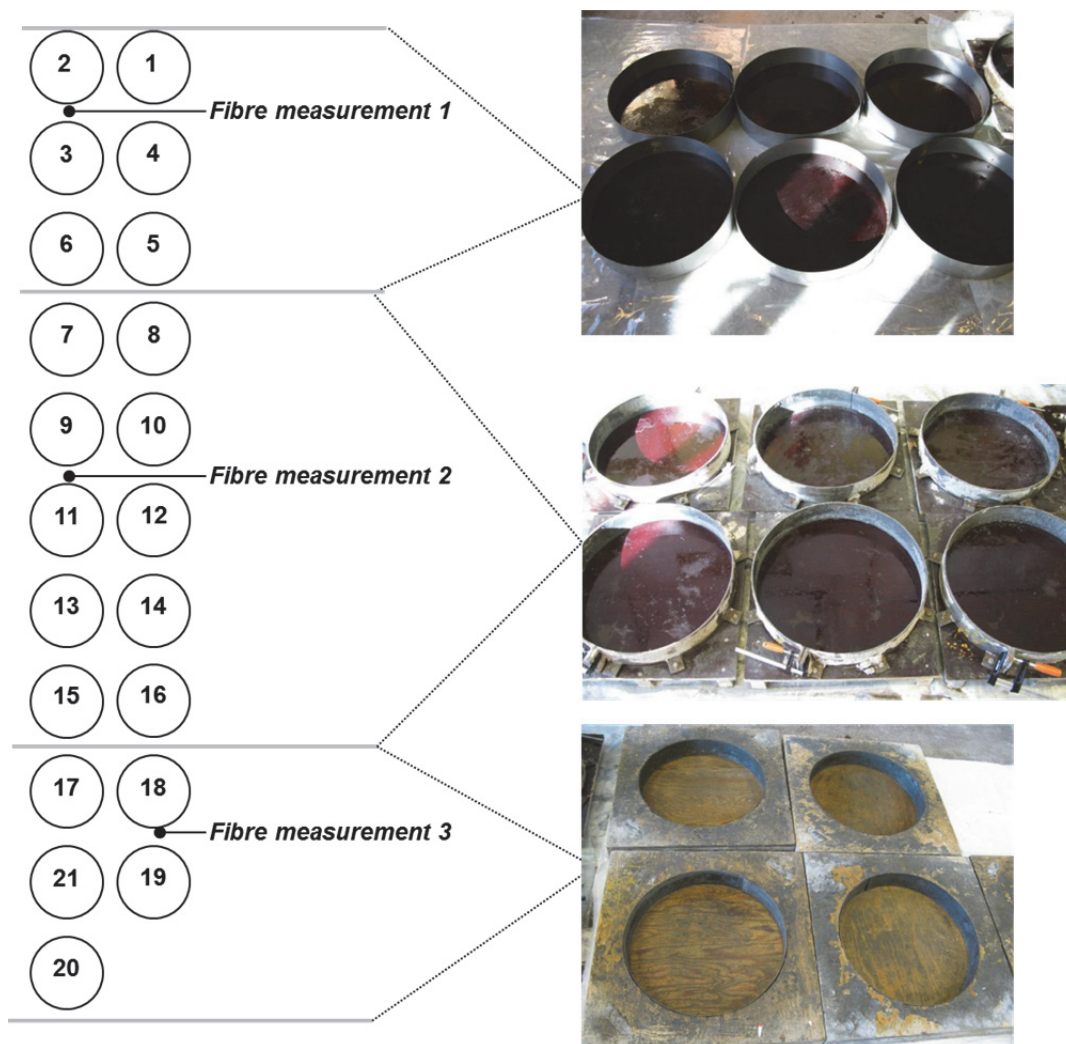

**Figure 2** Overview of casting sequence (corresponds to panel number), time of fibre measurements and type of panel moulds.

The last litres of concrete was used to cast an extra panel (number 21), but this one got less thickness (83 mm thick) due to lack of concrete. This panel is not part of the evaluation, even though it was tested.

## 2.2 Fibre content and fibre distribution

The three single measurements of fibre content during casting of panels (early, middle and late in the casting sequence) are shown in Table 2. It can be seen that the deviation from the nominal fibre content of 31 kg is quite small for all three samples and that the measured average fibre content was 30.2 kg, which is only -2.7% from the nominal. The sampling was done with the 8 litres container for measuring air content, and then poured into larger buckets. Each concrete sample was poured in portions on to a 2 mm sieve where the binder phase/fines was washed out leaving fibres and coarse aggregates on the sieve. The fibres were then collected by use of a magnet, see Figure 3. In the end the procedure was repeated to collect the few fibres that had passed the sieve together with the binder during the first round. The three samples with extracted fibres were stored in air for drying until the next day when the weight of fibres was measured.

**Table 2 Fibre content measurements**

Meas. No.	Sample volume [l]	Tot. weight [kg]	Weight of container [kg]	Weight of sample [kg]	Weight of fibres [g]	Concrete density [kg/l]	Fibre content [g/l]	Deviation from 31 kg nominal	Fiber content, average		
									Average [g/l]	Std.dev. [g/l]	COV [-]
1	7,988	22,811	4,632	18,179	250,9	2,28	31,41	0,41 %	30,2	3,6	11,9 %
2	7,988	22,742	4,632	18,110	263,2	2,27	32,95	1,95 %			
3	7,988	22,778	4,632	18,146	208,6	2,27	26,11	-4,89 %			



**Figure 3 Fibre measurement of a 8 litre sample; 2 mm sieve, washing and steel fibre collection with magnet**

### 2.3 28-days compressive strength

Average 28-days compressive strength among the three 100 mm cubes was 57.8 MPa, and the average density among the same cubes was 2290 kg/m<sup>3</sup>. It is notable that the panel tests described in the following chapters was done after 92 days, consequently the actual compressive strength of the panels at testing was somewhat higher; probably around 65 MPa (considering the used cement).

## 3 Packing, shipment and distribution of panels

After 6 days of curing in the SINTEF-T laboratory the panels were de-moulded and packed for shipment. The panels were covered with wet burlap sacks and outward plastic sheets. Each laboratory was to receive 5 panels, and the panels for each lab were picked as to cover as much of the casting sequence as possible. The panels were distributed as follows:

SINTEF-T: 3, 7, 10, 15, 20 (not shipped; only stored)  
 SINTEF-O: 2, 6, 11, 14, 18 (21)  
 Mannvit: 4, 8, 9, 16, 17  
 NPRA: 1, 5, 12, 13, 19

Note that panel 21 (SINTEF-O) with deviating thickness (83 mm) is not included in the evaluations, as stated earlier. After receiving the package of panels at the various labs, the panels were stored as received for a period. After 32 days concrete age the panels were unpacked in all laboratories and water cured until testing. The actual test dates varied from 90 to 92 days among the labs. In any case, the test dates were close and the concrete maturity is high. It should therefore have no significance to the results, and this issue is not dealt with further. The treatment of the panels is summarized in Table 3.

**Table 3 Coordinated treatment and testing of panels**

	<b>Date</b>	<b>Concrete age</b>
Concrete mixing and casting	31.03.2011	0
Packing/shipment	06.04.2011	6
Water curing	02.05.2011	32
Testing of panels I	29.06.2011	90
Testing of panels II	30.06.2011	91
Testing of panels III	01.07.2011	92

## **4 Test and analysing procedure - Energy absorption capacity**

---

Dimensions and example of test set-up are given in Figure 4 and Figure 5. Nominal panel diameter and thickness are 600 mm and 100 mm, respectively. The test- and analysing procedure was done according to NB 7: 2011.

The test procedure is briefly as follows:

- 1) The test panel is removed from the water bath. The panel shall be moist during testing.
- 2) The diameter of the test panel is measured using a ruler.
- 3) The thickness of the test panel is measured at 6 locations along the rim using a slide gauge.
- 4) Abnormalities or faults with the test panel shall be registered and noted in the test report.
- 5) The test panel is placed in the testing rig with its moulded/smooth surface directly on the steel support ring and centred. No bedding material shall be used in between the test panel and the support.
- 6) A circular, steel loading block with a diameter of 100 mm and minimum thickness of 20 mm is placed concentrically on the panel's rough surface.
- 7) The displacement transducer (with swivel plate) is set up and centred beneath the panel (against smooth/moulded side).
- 8) The test can start. The load is displacement controlled at a constant rate of 3 mm/min ( $\pm 0.3$  mm/min). The load and deflection signal shall be continuously recorded. The test is finished when the central deflection reaches 30 mm.
- 9) After testing, the test panel is removed from the test rig and turned over. The number of cracks on the panel's underside is recorded.

The analysing procedure is as follows:

From each test the area  $A_{P,\Delta}$  under the load-displacement curve up to the limit displacement  $\Delta_m = 25$  mm  $\times k_t$  (=correction factor for thickness) is calculated. The Energy absorption ( $E_{abs}$ ) from the test is then calculated by multiplying  $A_{P,\Delta}$  with the factor  $k_t$  and with the factor  $k_f$  (=correction factor for friction).

**Equation 1** 
$$E_{\text{abs}} = k_t \cdot k_f \cdot A_{P-\Delta}$$

Where 
$$A_{P-\Delta} = \sum_{i=0}^{\Delta_m} \left[ (\Delta_{i+1} - \Delta_i) \frac{P_i + P_{i+1}}{2} \right]$$

Symbol explanation

Energy absorption from the panel test:	$E_{\text{abs}}$
Accumulated area under the load-displacement curve up to the limit displacement $\Delta_m$ :	$A_{P-\Delta}$
Nominal panel thickness:	$t_0 = 100 \text{ mm}$
Measured average panel thickness (mm):	$t$
Correction factor for thickness:	$k_t = \frac{t_0}{t}$
Limit displacement:	$\Delta_m = 25 \text{ mm} \cdot k_t$
Displacement (mm):	$\Delta$
Load (kN):	$P$
Correction factor for friction against the support:	$k_f = 0.75$

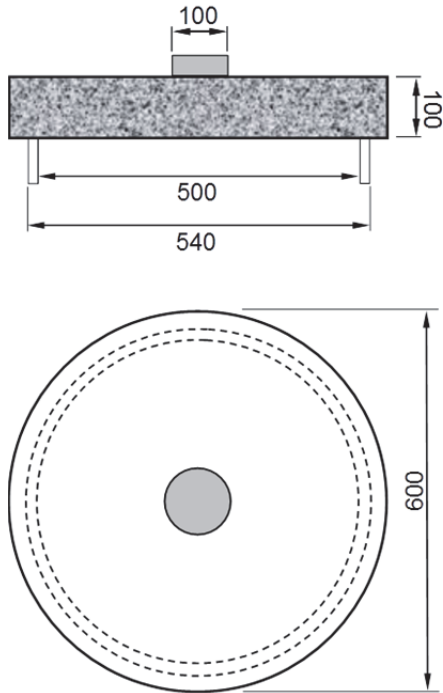

**Figure 4 Round panel tests: Dimensions (mm). The steel supporting ring is the dashed line. Ref. NB 7: 2011**

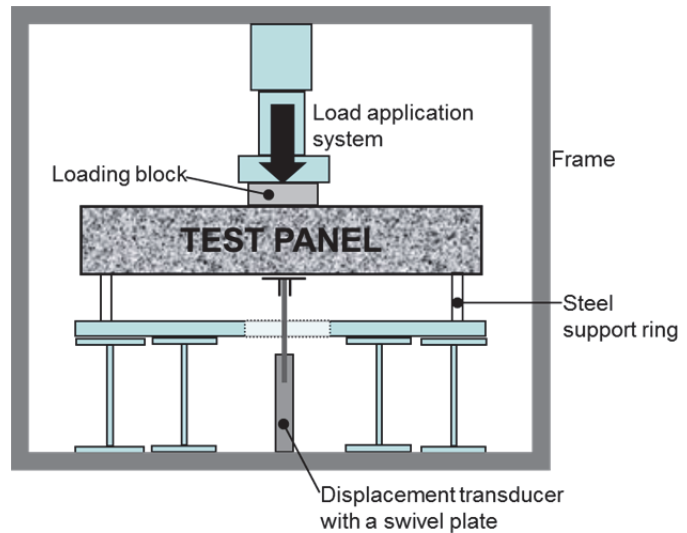

**Figure 5 Round panel test: Example of test set-up. Ref. NB 7:2011**

## 5 Round panel tests - results and discussion

---

### 5.1 General

In the following presentation of results, the different labs are denoted Lab1 to Lab4, according to:

SINTEF-T:	Lab1
SINTEF-O:	Lab2
Mannvit:	Lab3
NPRA:	Lab4

Statistical expressions and parameters are given in some standards, for instance [2]. The most relevant ones are listed and briefly dealt with below as an introduction to the following sections.

Accuracy of a measuring method is divided into *trueness* and *precision*.

- *Trueness* is of interest when a true value of a property is known. In our case neither a true value of the energy absorption capacity of the concrete is known, nor is there an accepted reference value. The trueness is therefore a subject which is not relevant in the present study.

- *Precision* is linked to the variability/random error inherent in every measurement procedure used to perform tests under presumably identically circumstances. Precision is therefore the subject of discussion here. Precision is divided into the two terms *repeatability* and *reproducibility*, the two terms is explained below.

Many factors may influence *precision*, i.e. contributing to the variability of results from a measuring method:

- a) sampling error/variability among the samples.  
Concrete is an inhomogeneous material and some inherent variations are avoidable.
- b) the operator
- c) the equipment used
- d) the calibration of the equipment
- e) the environment (temperature, humidity, etc)
- f) the time elapsed between measurements

The variability connected to *factor a)* is presumably minimized as all round panels were mixed and cast from one single batch of concrete under controlled laboratory conditions. After each lab received sets of panels from this batch the panels were presumably stored similarly until testing. Potentially the different transport methods and -time (road/boat transport) could have had an effect on the panels, but any such affect is, however, unknown.

Under *repeatability* conditions factors b) to f) are generally constant and do not contribute to variability. For this condition (should be relevant within the same lab) the standards operate with the term within-laboratory variance, and in the following the term “within-lab variation” is used, referring to this condition.

Under *reproducibility* conditions the same factors b) to f) may vary and contribute to the variability. This condition typically applies for inter-laboratory studies, and the term between-laboratory variance is used in the standards. In the following the term “between-lab variation” is used, referring to this condition.

Since average energy absorption capacity results from the labs vary it is convenient to use the coefficient of variation (COV) as the main measure of variability instead of variance and standard deviation.

## 5.2 Measurements of panel thickness and diameter

The measurements of panel thickness and diameter are given in APPENDIX 1. Measured average dimensions for each panel were very close to the intended dimensions of  $\text{Ø}600$  mm and  $t=100$  mm. And, for each panel the standard deviation among the measurements were small. An example of a panel thickness measurement is shown in Figure 6.



Figure 6 Example of panel thickness measurement with slide gauge

## 5.3 Energy absorption capacity results, within-lab and between-lab variation

### 5.3.1 Introduction to the evaluation

All energy absorption capacity results and curves are presented versus normalized displacement axes when it comes to panel thickness (i.e. the displacement record in each test has been divided by the correction factor for thickness  $k_t$ ). Hence, results in figures and tables can be compared directly at any given displacement level. The raw data record from every panel test is given in APPENDIX 2, pictures of panels after testing is given in APPENDIX 3 and out-prints from the Excel evaluation spread sheet is given in APPENDIX 4.

Based on thousands of sets of 2 and 3 ASTM C1550 round panels [8] it has been shown that such tests are normal distributed about the arithmetic mean (average). We assume that the ASTM C1550 method represents the same statistically features as the present NB 7:2011 round panel method.

For the present Round-Robin, according to [4], the scatter among the 5 single test results at each lab is within specified ranges so that the test results from each lab can be represented by an average result (with a standard deviation and coefficient of variation COV).

### 5.3.2 Within-lab variation (repeatability)

Table 4 and Figure 7 shows average energy absorption capacity (i.e. accumulated energy uptake up to 25 mm normalized displacement) for each set of 5 panels from the various labs. Average accumulated energy uptake with displacement at each lab is shown in Figure 8. As can be seen, the average energy absorption capacity (25 mm) varied from 824 Joule to 918 Joule among the labs, and the (within-lab) standard deviation varied from 45 to 105 Joule, corresponding to (within-lab) COVs varying from 5.5% to 12.2%. Overall average (within-lab) COV among the labs is 9.0%.

These numbers for COV must be regarded as normal considering previous results from Norway [5] and internationally [6]. As discussed in [5], among 52 individual sets tested at NPRA (most of them from different batches) the standard variation range for COV was 2.7% to 14.3% and the average COV among the all individual sets was 8.5%. In a previous Round-Robin test program in COIN [7] on ASTM C1550 panels (somewhat different method, but very comparable), involving 4 labs, the COVs among 19 individual sets of 4 panels varied from 6% to 22%, and overall average COV was 12.0%. And, in [8], involving two Round-Robin programs (four and six labs participated, respectively), ten concrete mixes and nearly 500 ASTM C1550 round panels, the within-lab COVs were in the range 10-12%.

**Table 4 Average energy absorption capacity up to 25 mm (normalized) displacement for each lab, and within-lab variation in terms of standard deviation and COV**

Lab. No	Energy absorption capacity (average of 5 panels) [Joule]	Within-lab Standard deviation [Joule]	Within-lab COV [-]
Lab1	918	68	7,4 %
Lab2	864	105	12,2 %
Lab3	824	45	5,5 %
Lab4	882	98	11,1 %

Average = 79,0      Average = 9.0%

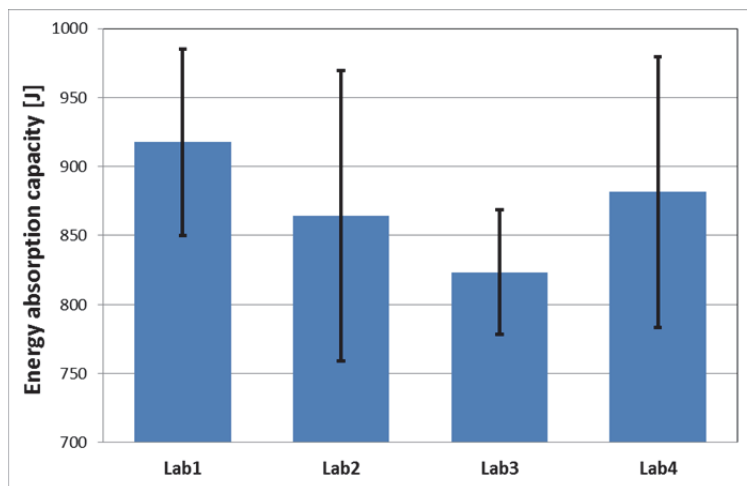

**Figure 7 Average Energy absorption capacity (25 mm) from each lab with corresponding  $\pm$  standard deviation indicated. Note energy axis from 700-1000 Joule.**

A test result, according to NB 7:2011, is the average of (normally) 3 panels. In this study 5 panels were tested at each lab, and thus is the basis for the within-lab average result, standard deviation and COV. It is notable that the variation for 5 panels will on average be somewhat higher than for 3 panels [9]. This phenomenon is linked to the expectation that the expected value of a sample deviation is less than the standard deviation of the whole population. It will be shown below that the present data are in line with this phenomenon.

If we consider all combinations of 3 and 3 panels among the 5 tested panels at each lab we have 10 possible combinations. For each of the combinations (sets) of 3 panels we can calculate the average energy absorption capacity (see Figure 9) and COV (see Figure 10). For each lab the average COV of these 10 combinations becomes as follows: Lab1=7.1%, Lab2=11.0%, Lab3=5.1% and Lab4=10.5%. We can see that these average COV-values based on 3 and 3 panels are slightly lower than the COVs in Table 4 based on all 5 panels, as expected. Furthermore, the combination of 3 panels giving the lowest COV (see Figure 10) for each lab is 0.9%, 3.2%, 2.1% and 5.3%, respectively for Lab 1 to Lab 4. Correspondingly, the combination of 3 panels with highest COV is

8.5%, 17.1%, 7.5% and 15.7%, respectively for Lab 1 to Lab 4. All these COVs must be regarded normal values for sets of 3 and 3 panels considering previous experience.

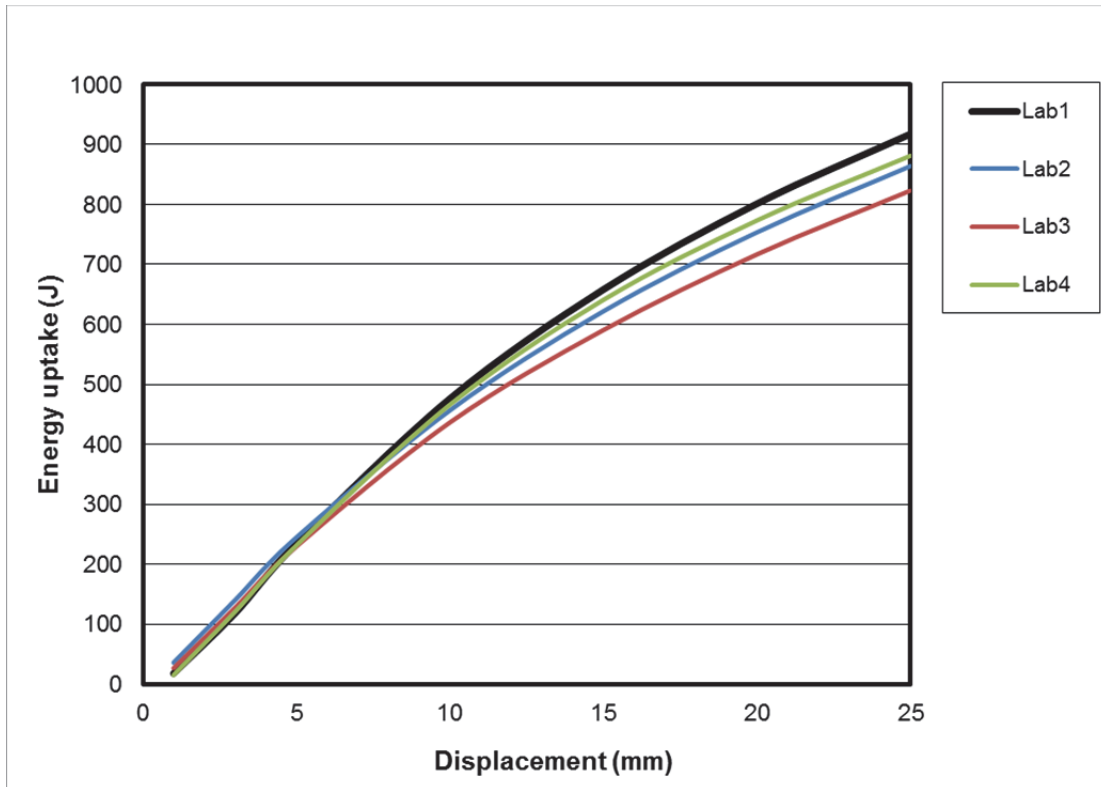

Figure 8 Energy uptake vs. displacement (normalized with regard to panel thickness), average result at each lab.

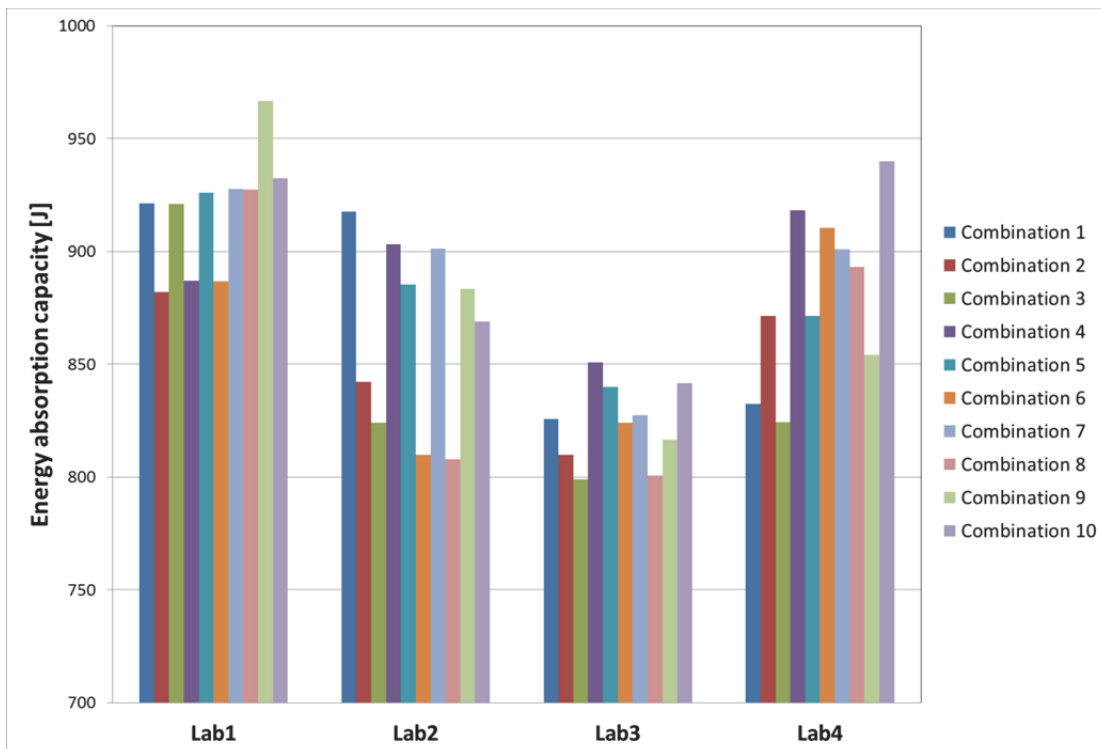

Figure 9 Average Energy absorption capacity (25 mm) for the 10 combinations of 3 and 3 panels among the 5 tested panels at each lab. Note energy axis from 700-1000 Joule



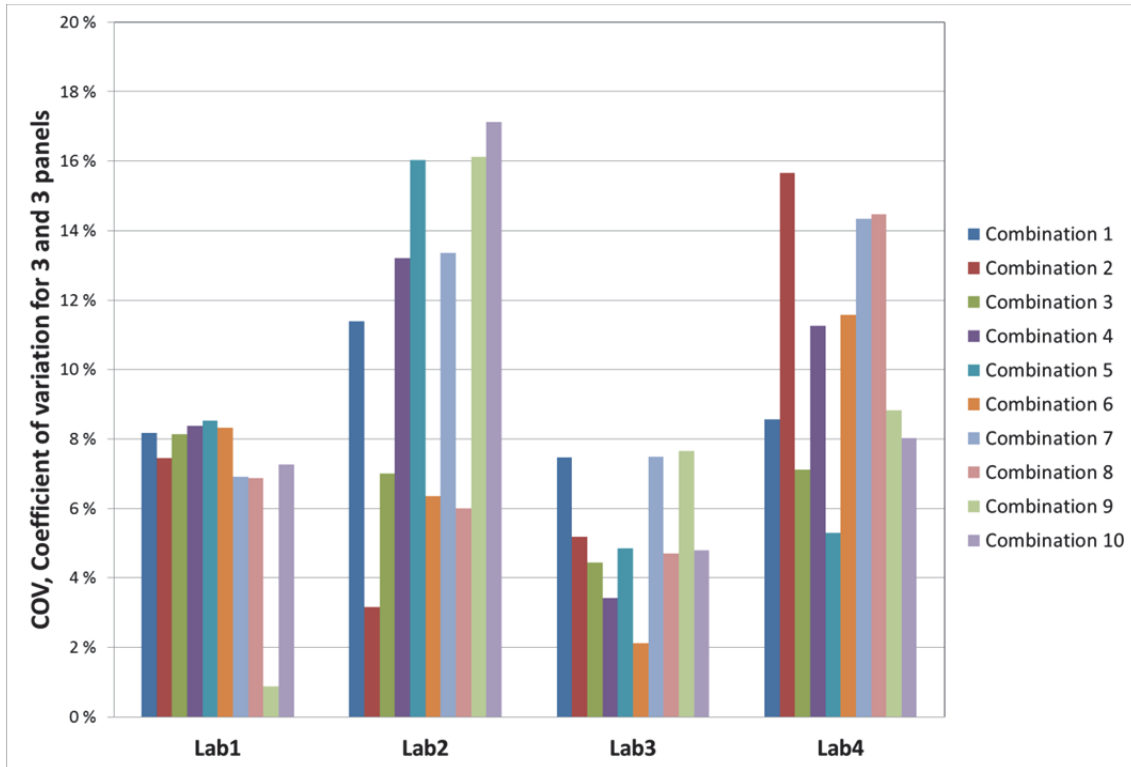

Figure 10 COV for the 10 combinations of 3 and 3 panels among the 5 tested panels at each lab

The sixth panel tested at Lab2 (panel no. 21) is not included in the results and evaluation since it was a deviating panel with a thickness of only 83 mm. It is however interesting to note that the test result from panel 21 still corresponds well with the results from the other five (normal) panels close to 100 mm thick. The result from panel 21 was naturally also corrected for panel thickness and friction, as described in the results analysing procedure in NB 7:2011 (see APPENDIX 2 and APPENDIX 4 for panel 21 test results).

### 5.3.3 Between-lab variation (reproducibility)

Key numbers regarding between-lab variability is given in Table 5. Comparing simply the average results from each lab (within-lab average results) it can be seen that the overall average energy absorption capacity for all labs was 872 Joule, the between-lab standard deviation is 39 joule, which represents a COV of only 4.5 %.

According to [3], the estimate of reproducibility variance  $s_R^2$  shall be calculated as follows:

$$\text{Equation 2} \quad s_R^2 = s_L^2 + s_r^2$$

where:

$s_L^2$  is the estimate of the between-lab variance and

$s_r^2$  is the arithmetic mean of the within-lab variance of the labs

As the standard deviation is the square root of the variance we have that  $s_L = 39$  Joule and  $s_r = 79$  Joule (taken from the previous section), hence we get the following numbers in Equation 2:  $s_L^2 = 39^2 + 79^2$ ; thus  $s_L$  (the reproducibility standard deviation) becomes 88 Joule. If we then divide  $s_L$  by the overall average energy absorption capacity 872 Joule we get a COV of 10.1 %, which then is an estimate of COV for the reproducibility of results between the labs.

**Table 5 Average energy absorption capacity (25 mm) at each lab and between-lab variability**

Lab. No	Energy absorption capacity (average of 5 panels) [Joule]
Lab1	918
Lab2	864
Lab3	824
Lab4	882
Overall average:	<b>872</b>
Std.dev. of between-lab average:	39
COV of between-lab average:	4,5 %
Std.dev. (reproducibility) according to Equation 2:	<b>88</b>
COV (reproducibility) according to Equation 2:	<b>10,1 %</b>

The previous Round-Robin in COIN [7] (discussed earlier) showed between-lab COVs from 10% to 15% among average results of nominally identical sets of panels, and overall average between-lab COV was 13.2%. In [8] (also discussed) the average between-lab COV was 8.7%. Hence, the variation expressed in Table 5 for the present results must be regarded satisfactory in the way that it is clearly no higher than what could be expected.

Furthermore, it is notable that the difference between highest and lowest average energy absorption capacity is 94 Joule among the labs. Let us again divide the 5 panels at each lab into the 10 possible combinations (sets) of 3 and 3 panels. It is notable that for Lab1 (with highest overall average) the average energy absorption capacity (see Figure 9) for each of all 10 combinations is larger than the average for all combinations of 3 panels for Lab3 (with lowest overall average). It is also notable that Lab2, having the highest within-lab COV (see Table 4 and Section 5.4), has both the highest and the lowest single panel result of all labs. And Lab4, with second highest within-lab COV, has highest/lowest single panel result very close to Lab2.

As additional information the average numbers for maximum load and residual load within each lab is shown in Table 6, as well as the between-lab variation. These numbers are not dealt with further. More details for single lab results are given in the following sections.

**Table 6 Average maximum load, displacement at maximum load and residual load at 25 mm within each lab, as well as between-lab variation.**

Record	Lab1	Lab2	Lab3	Lab4	Average all labs	Between-lab Std.dev.	Between-lab COV
Maximum load (kN)	86	77	75	81	80	4,5	5,7 %
Displ. at max. load (mm)	3,1	1,9	2,3	2,7	2,5	0,5	20,1 %
Residual load at 25 mm (kN)	28	27	26	26	27	1,0	3,6 %

### 5.3.4 All 20 panels evaluated as one group

As an extra exercise, all panels have been evaluated as one group in the following, see Figure 11. When all 20 panel tests are treated as one large group (set) we get the following results: Average energy absorption capacity (25 mm) is 872 Joule, standard deviation is 83 Joule, and COV is 9.6%. We note that the COV for all 20 panels is slightly higher than the within-lab average COV (9.0%, see Table 4) based on the sets of 5 and 5 panels. This can be explained by the fact that the standard deviation has a tendency to increase with the number of samples, as discussed previously. Finally, Figure 12 shows the energy absorption capacity (25 mm) for all single panel tests. The figure displays no systematic effect of the casting sequence (reflecting the panel number) on the result.

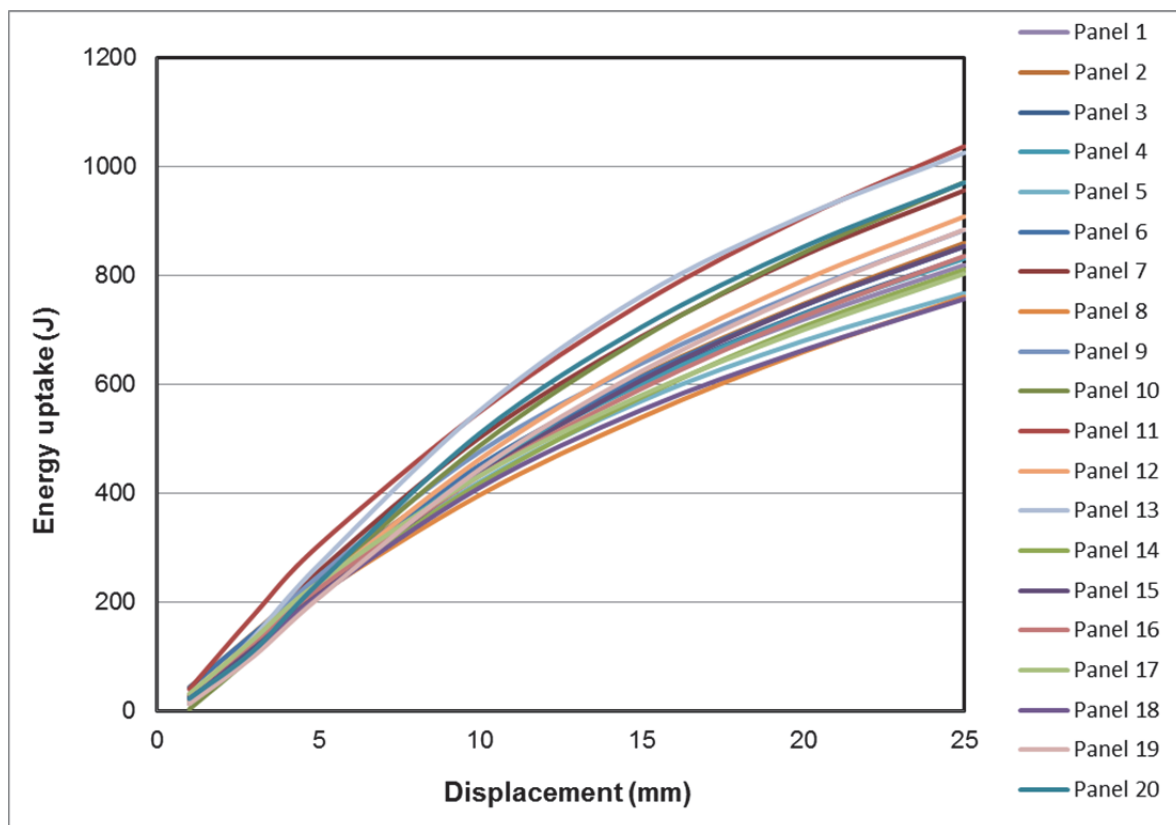

Figure 11 Energy uptake vs. displacement for all single panel tests

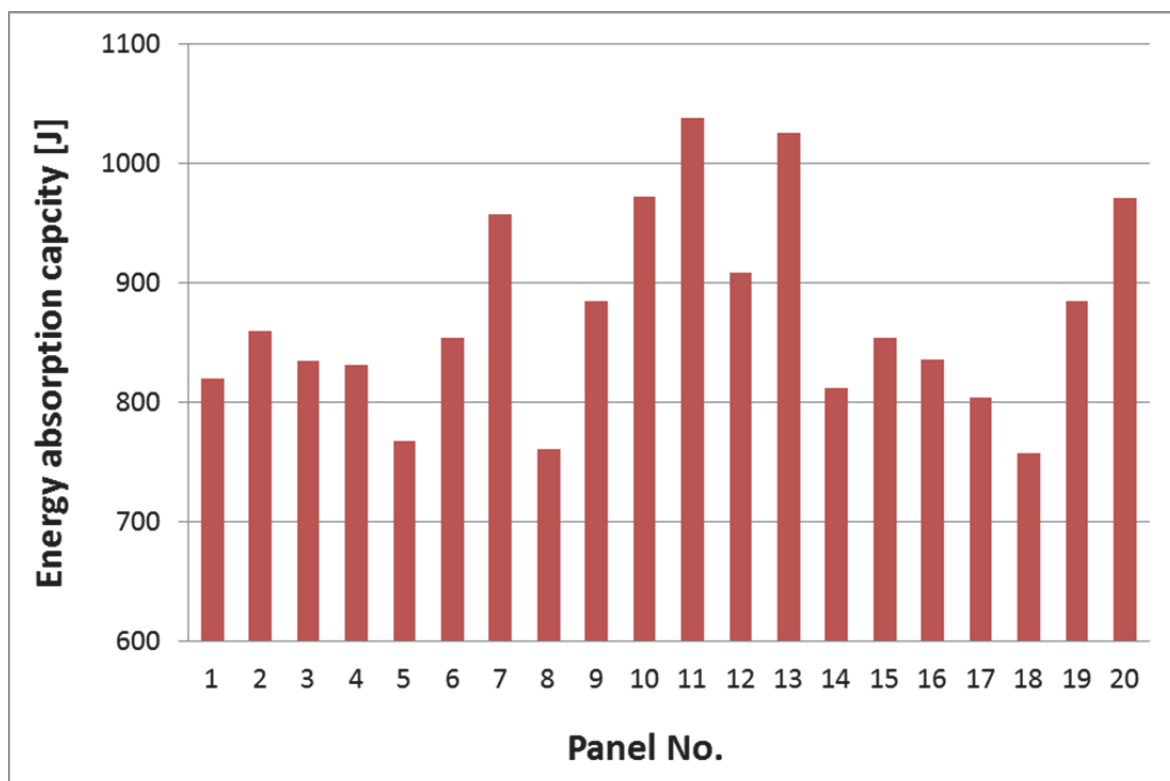

Figure 12 Energy absorption capacity (25 mm) for all single panel tests. Note energy axis from 600-1100 Joule

## 5.4 Single round panel test results; lab-by-lab

### 5.4.1 Results Lab1

Table 7 Energy uptake and load results, Lab1

Lab1	Energy uptake (J)					Average	Std.dev.	COV
Displ. [mm]	Panel 3	Panel 7	Panel 10	Panel 15	Panel 20			
1,0	21	14	4	27	23	18	9,2	52,1 %
3,0	122	133	106	117	112	118	10,3	8,7 %
5,0	226	257	234	219	236	234	14,2	6,0 %
10,0	444	503	488	435	511	476	34,7	7,3 %
15,0	604	689	686	608	706	658	48,4	7,4 %
20,0	731	837	842	745	853	801	58,8	7,3 %
<b>25,0</b>	<b>835</b>	<b>957</b>	<b>972</b>	<b>854</b>	<b>971</b>	<b>918</b>	<b>67,6</b>	<b>7,4 %</b>

Lab1	Load					Average	Std.dev.	COV
	Panel 3	Panel 7	Panel 10	Panel 15	Panel 20			
Maximum load (kN)	78	92	94	75	89	86	8,8	10,3 %
Displ. at max. load (mm)	1,8	2,7	3,2	3,0	4,6	3,1	1,0	33,1 %
Residual load at 25 mm (kN)	26	29	32	27	29	28	2,2	7,8 %

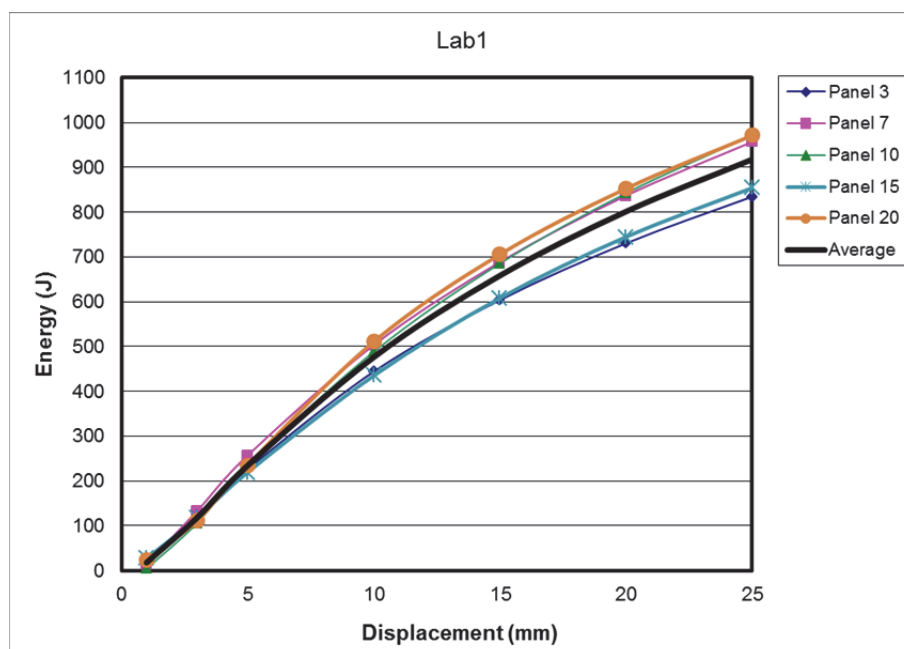

Figure 13 Energy uptake vs. displacement for the 5 panels tested in Lab1

## 5.4.2 Results Lab2

**Table 8 Energy uptake and load results, Lab2**

Lab2		Energy uptake (J)					Average	Std.dev.	COV
Displ. [mm]	Panel 2	Panel 6	Panel 11	Panel 14	Panel 18				
1,0	44	44	41	29	23	36	9,4	26,1 %	
3,0	144	143	177	126	110	140	25,1	17,9 %	
5,0	244	241	305	222	212	245	35,9	14,7 %	
10,0	452	452	551	419	411	457	55,7	12,2 %	
15,0	617	614	749	577	554	622	75,9	12,2 %	
20,0	748	745	907	707	663	754	92,2	12,2 %	
<b>25,0</b>	<b>860</b>	<b>854</b>	<b>1038</b>	<b>812</b>	<b>758</b>	<b>864</b>	<b>105,5</b>	<b>12,2 %</b>	

Lab2		Load					Average	Std.dev.	COV
		Panel 2	Panel 6	Panel 11	Panel 14	Panel 18			
Maximum load (kN)		78	75	95	70	70	77	10,3	13,3 %
Displ. at max. load (mm)		0,9	1,5	1,2	1,8	4,2	1,9	1,3	68,6 %
Residual load at 25 mm (kN)		28	28	32	25	23	27	3,4	12,3 %

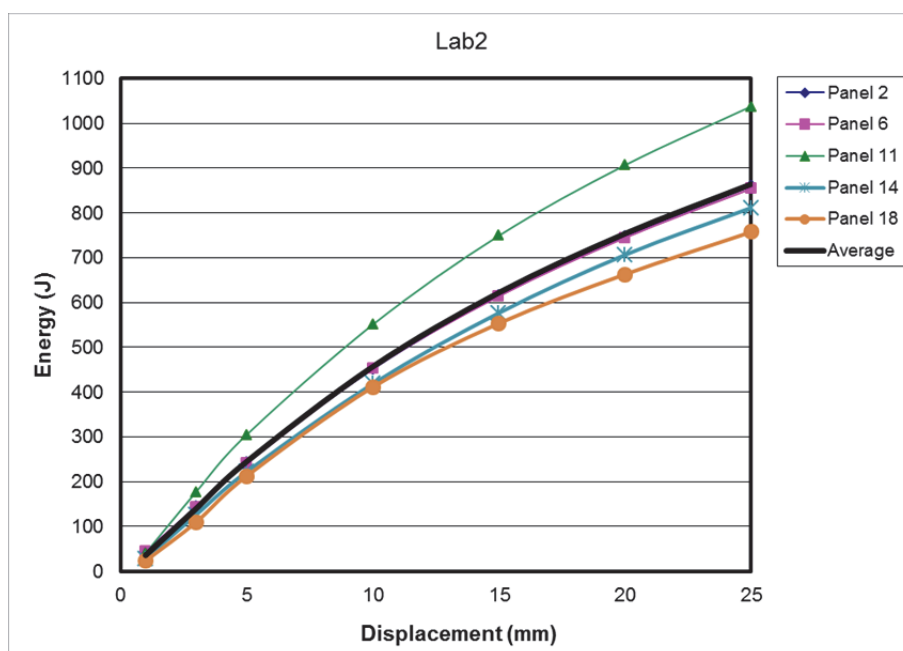

**Figure 14 Energy uptake vs. displacement for the 5 panels tested in Lab2**

### 5.4.3 Results Lab3

Table 9 Energy uptake and load results, Lab3

Lab3		Energy uptake (J)					Average	Std.dev.	COV
Displ. [mm]	Panel 4	Panel 8	Panel 9	Panel 16	Panel 17				
1,0	20	26	24	32	32	27	4,9	18,5 %	
3,0	122	119	135	128	133	127	7,1	5,6 %	
5,0	224	215	248	225	236	230	12,9	5,6 %	
10,0	443	398	477	433	433	437	28,4	6,5 %	
15,0	602	540	639	593	581	591	35,8	6,1 %	
20,0	728	660	771	725	701	717	40,7	5,7 %	
<b>25,0</b>	<b>832</b>	<b>761</b>	<b>884</b>	<b>836</b>	<b>804</b>	<b>824</b>	<b>45,2</b>	<b>5,5 %</b>	

Lab3		Load					Average	Std.dev.	COV
		Panel 4	Panel 8	Panel 9	Panel 16	Panel 17			
Maximum load (kN)		77	70	84	72	73	75	5,6	7,4 %
Displ. at max load (mm)		1,8	2,5	2,2	1,9	2,9	2,3	0,5	19,9 %
Residual load at 25 mm (kN)		26	25	28	28	26	26	1,1	4,3 %

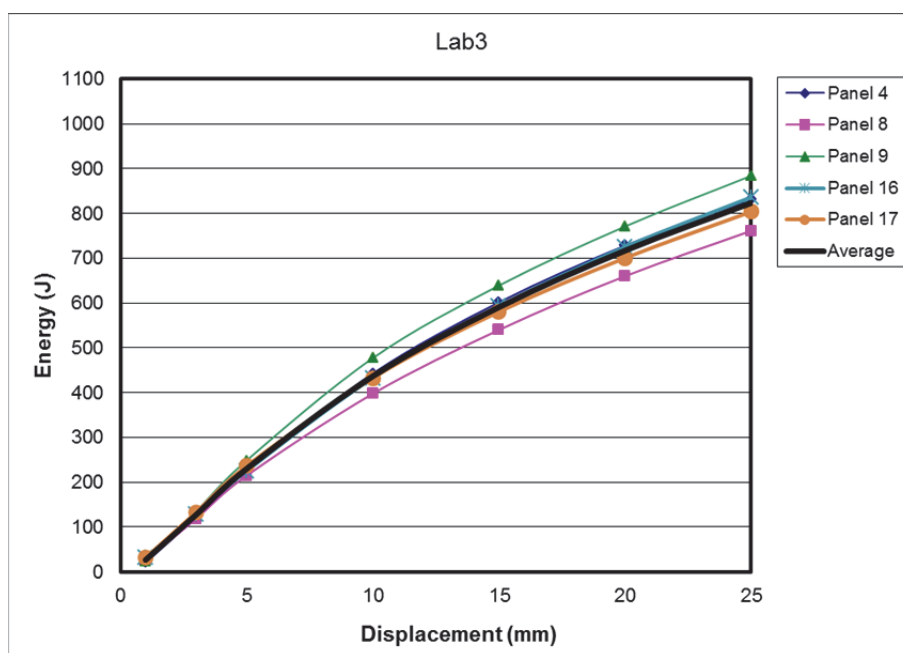

Figure 15 Energy uptake vs. displacement for the 5 panels tested in Lab3

### 5.4.4 Results Lab4

Table 10 Energy uptake and load results, Lab4

Lab4		Energy uptake (J)					Average	Std.dev.	COV
Displ. [mm]	Panel 1	Panel 5	Panel 12	Panel 13	Panel 19				
1,0	15	14	19	14	14	15	2,1	13,7 %	
3,0	124	119	122	137	101	120	12,7	10,5 %	
5,0	235	216	230	269	208	231	23,4	10,1 %	
10,0	449	422	464	553	445	466	50,6	10,9 %	
15,0	602	570	647	763	625	641	73,7	11,5 %	
20,0	719	680	791	910	767	774	87,4	11,3 %	
<b>25,0</b>	<b>820</b>	<b>768</b>	<b>909</b>	<b>1026</b>	<b>885</b>	<b>882</b>	<b>97,9</b>	<b>11,1 %</b>	

Lab4		Load					Average	Std.dev.	COV
	Panel 1	Panel 5	Panel 12	Panel 13	Panel 19				
Maximum load (kN)	77	75	83	96	73	81	9,2	11,4 %	
Displ. at max. load (mm)	2,7	1,4	1,9	3,6	3,9	2,7	1,1	39,6 %	
Residual load at 25 mm (kN)	25	22	27	28	29	26	3,0	11,2 %	

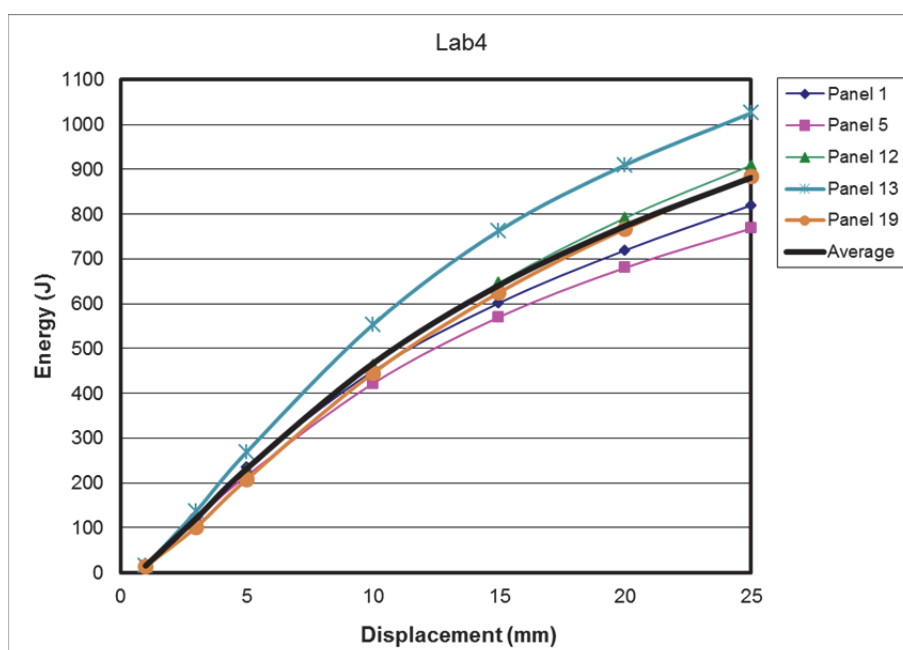

Figure 16 Energy uptake vs. displacement for the 5 panels tested in Lab4

## 6 Conclusion

---

The within-lab (repeatability) COV for energy absorption capacity from five panels at each lab varied from 5.5% to 12.2%, and overall average within-lab COV among the four labs was 9.0%. The between-lab variation among the average energy absorption capacity results from each lab was low; the COV was only 4.5%. An estimate on the between-lab reproducibility corresponds to a COV of 10.1 %. These COV-values are in the same range as previous results reported in the literature and must therefore be considered normal and satisfactory.

Among the four labs the average energy absorption capacity varied from 824 Joule to 918 Joule. A typical result from each lab can be expected to be represented by the average result  $\pm$  the standard deviation (i.e. a confidence interval of 68%). In such case the results overlap, leading to the simple conclusion that the differences among the labs are insignificant.

A panel test is normally reported as the average result of three panels, which is in accordance with NB 7:2011. The present Round-Robin involved five panels at each lab. It appears therefore relevant to consider the ten different combinations of three and three panels that are possible among the five panels. For example, it is notable that for the lab with the highest overall average result (among five panels) all ten average results from the combinations of three and three panels are larger than all the ten combinations from the lab with the lowest overall average result (among five panels). It can be suspected that some of the differences in average results that are seen are of more general character rather than coincidental, but the answer to this could only be found by further Round-Robin tests.



## References

---

- [1] Norwegian Concrete Association publication no. 7: “Sprayed concrete for rock support”, 2011
- [2] ISO 5725-1:1994 Accuracy (trueness and precision) of measurement methods and results – Part 1: General principles and definitions
- [3] ISO 5725-2:1994 Accuracy (trueness and precision) of measurement methods and results – Part 2: Basic methods for the determination of repeatability and reproducibility of a standard measurement method
- [4] NS-EN 932-6:1999 Tests for general properties of aggregate – Part 6: Definitions of repeatability and reproducibility
- [5] Bjøntegaard Ø. and Myren S.A. (2011) The accuracy of FRS concrete panel tests. Tunneling Journal, Oct/Nov 2011, pp. 44-50
- [6] Bernard E.S. (2002) Correlation in the behaviour of fibre reinforced shotcrete beam and panel specimens. Materials and Structures, Vol.35, pp.156-164
- [7] Sandbakk S., Kanstad T., Bjøntegaard Ø., Vandewalle L. and Parmentier B. (2010) International round robin testing of circular FRC slabs. Reporting and evaluation of test results from Norway and Belgium. COIN-report 23-2010, SINTEF Building and Infrastructure, ISBN 978-82-536-1173-0
- [8] Bernard E.S. (2010) Precision of the ASTM C1550 panel test and field variation in measured FRS performance. Shotcrete: Elements of a system, Bernard (Ed.), 2010 Taylor & Francis Group, London, ISBN 978-0-415-47589-1, pp. 29-38
- [9] Bernard E.S. (2010) Influence of the number of replicates in a batch on apparent variability in FRC and FRS performance assessed using ASTM C1550 panels. Shotcrete: Elements of a system, Bernard (Ed.), 2010 Taylor & Francis Group, London, ISBN 978-0-415-47589-1, pp. 39-48

## APPENDIX 1 Measurements of panel thickness and diameter

Laboratory: SINTEF Byggforsk - Trondheim									
Test date: 30.06.2011									
		Panel no.							
		7	10	15	20	3			
<b>Panel thickness</b>		103	102	101	101	98			
		100	102	99	102	98			
		101	102	102	103	102			
		103	102	103	102	100			
		103	103	102	102	100			
		102	102	101	100	100			
		100	103	99	103	101			
		103	103	102	102	98	<b>All Average</b>	<b>All Std.dev</b>	<b>COV</b>
Average	101,9	102,4	102,0	101,9	99,6	101,6	1,1	1,08 %	
Highest	103,0	103,0	103,0	103,0	102,0				
Lowest	100,0	102,0	99,0	100,0	98,0				
Std.dev	1,4	0,5	1,5	1,0	1,5				
		7	10	15	20	3			
<b>Panel diameter</b>		602	602	603	597	600			
		598	600	598	595	602	<b>All Average</b>	<b>All Std.dev</b>	<b>COV</b>
		600	600	600	595	598	599,3	2,1	0,35 %
	Average	600,0	600,7	600,3	595,7	600,0	599,3	2,1	0,35 %
Highest	602,0	602,0	603,0	597,0	602,0				
Lowest	598,0	600,0	598,0	595,0	598,0				
Std.dev	2,0	1,2	2,5	1,2	2,0				

Laboratory: SINTEF Byggforsk - Oslo									
Test date: 01.07.2011									
		Panel no.							
		2	6	11	14	18			
<b>Panel thickness</b>		102	100	102	102	107			
		100	101	102	102	105			
		98	100	103	104	106			
		98	101	103	103	107			
		99	102	104	103	106			
		100	101	104	102	107	<b>All Average</b>	<b>All Std.dev</b>	<b>COV</b>
	Average	99,3	100,8	103,0	102,6	106,3	102,4	2,6	2,57 %
Highest	101,6	102,0	104,0	104,0	107,0				
Lowest	97,5	100,0	102,0	101,6	105,0				
Std.dev	1,4	0,8	0,9	0,9	0,8				
		2	6	11	14	18			
<b>Panel diameter</b>		600	599	600	599	597			
		600	601	598	598	596	<b>All Average</b>	<b>All Std.dev</b>	<b>COV</b>
		603	601	601	600	599	599,5	1,4	0,23 %
	Average	601,0	600,3	599,7	599,0	597,3	599,5	1,4	0,23 %
Highest	603,0	601,0	601,0	600,0	599,0				
Lowest	600,0	599,0	598,0	598,0	596,0				
Std.dev	1,7	1,2	1,5	1,0	1,5				

Laboratory: MANNVIT									
Test date: 30.06.2011									
		<b>Panel no.</b>					<b>All</b>	<b>All</b>	
	<b>4</b>	<b>8</b>	<b>9</b>	<b>16</b>	<b>17</b>	<b>Average</b>	<b>Std.dev</b>	<b>COV</b>	
<i>Av. panel thickness</i>	100	102	103	100	101	101,2	1,3	1,29 %	
<i>Av. panel diameter</i>	601	600	602	599	596	599,6	2,3	0,38 %	

Laboratory: NPRA									
Test date: 29.06.2011		and	01.07.2011						
		<b>Panel no.</b>							
		<b>1</b>	<b>5</b>	<b>12</b>	<b>13</b>	<b>19</b>			
<b>Panel thickness</b>		103	103	102	102	101			
		102	100	103	103	99			
		102	100	104	102	101			
		101	101	103	100	100			
		99	102	103	103	101			
		103	103	102	103	102	<b>Average</b>	<b>Std.dev</b>	<b>COV</b>
<i>Average</i>	101,6	101,3	102,7	102,3	100,7	101,7	0,8	0,78 %	
<i>Highest</i>	103,0	103,0	103,7	103,3	101,8				
<i>Lowest</i>	98,5	99,5	101,6	100,2	99,2				
<i>Std.dev</i>	1,6	1,4	0,7	1,2	0,9				
		<b>1</b>	<b>5</b>	<b>12</b>	<b>13</b>	<b>19</b>			
<b>Panel diameter</b>		600	602	605	603	594			
		602	596	599	600	596			
		602	598	599	597	595	<b>Average</b>	<b>Std.dev</b>	<b>COV</b>
	<i>Average</i>	601,3	598,7	601,0	600,0	595,0	599,2	2,6	0,43 %
<i>Highest</i>	602,0	602,0	605,0	603,0	596,0				
<i>Lowest</i>	600,0	596,0	599,0	597,0	594,0				
<i>Std.dev</i>	1,2	3,1	3,5	3,0	1,0				

## APPENDIX 2 Raw data records from the panel tests

(the curves below are not corrected for thickness and friction)

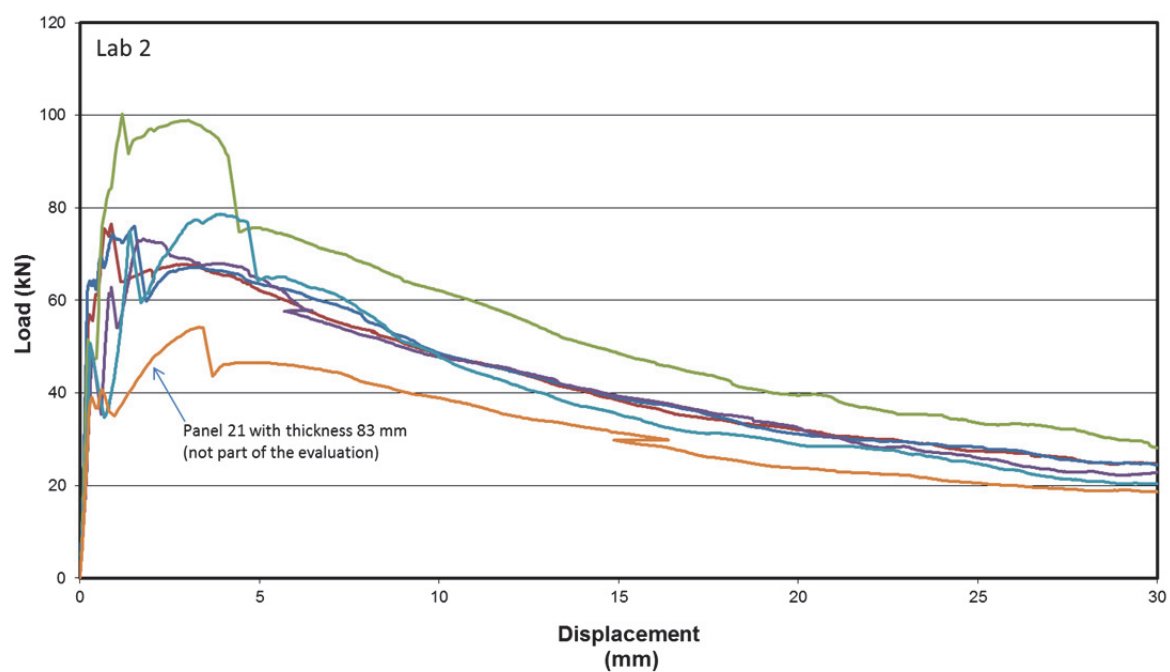
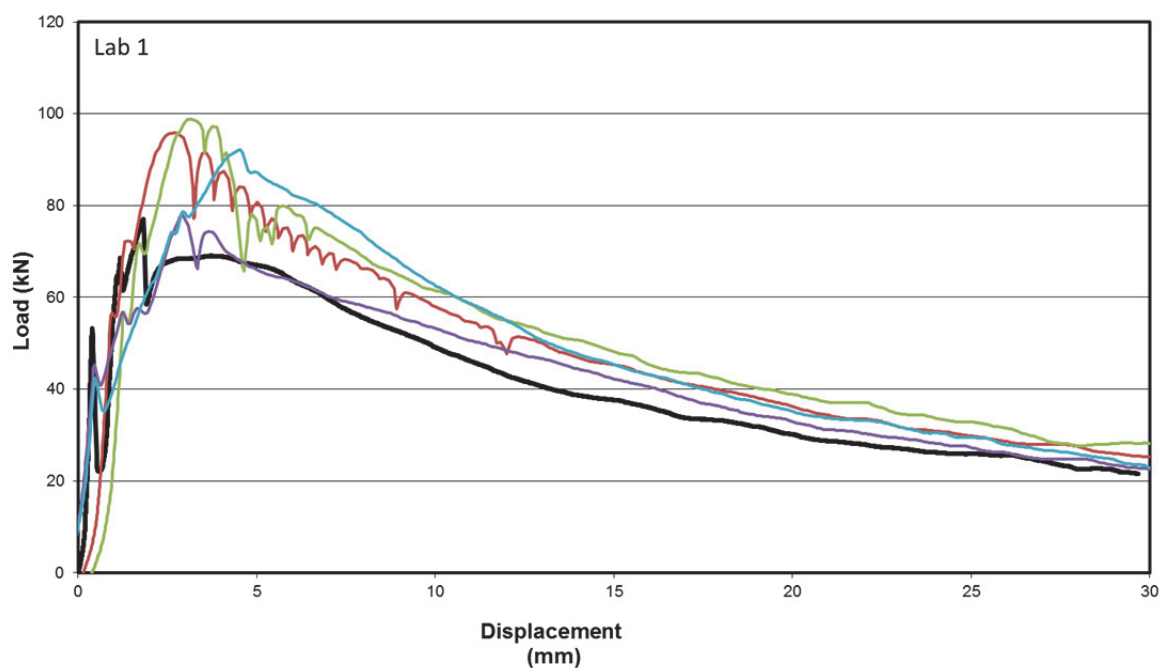

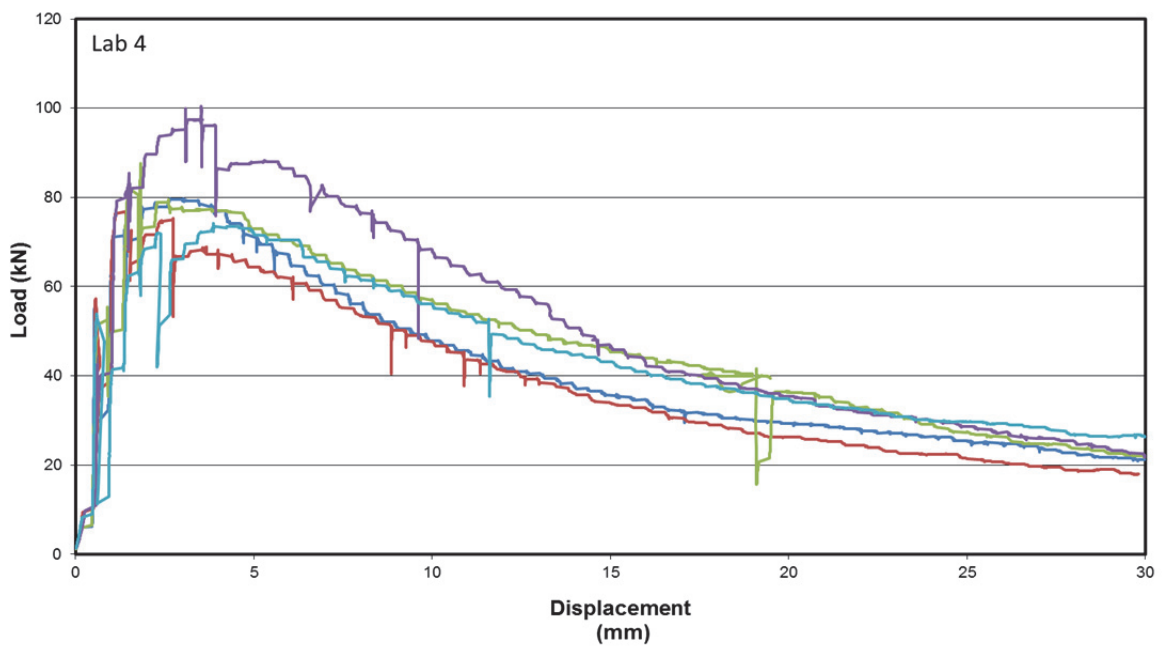
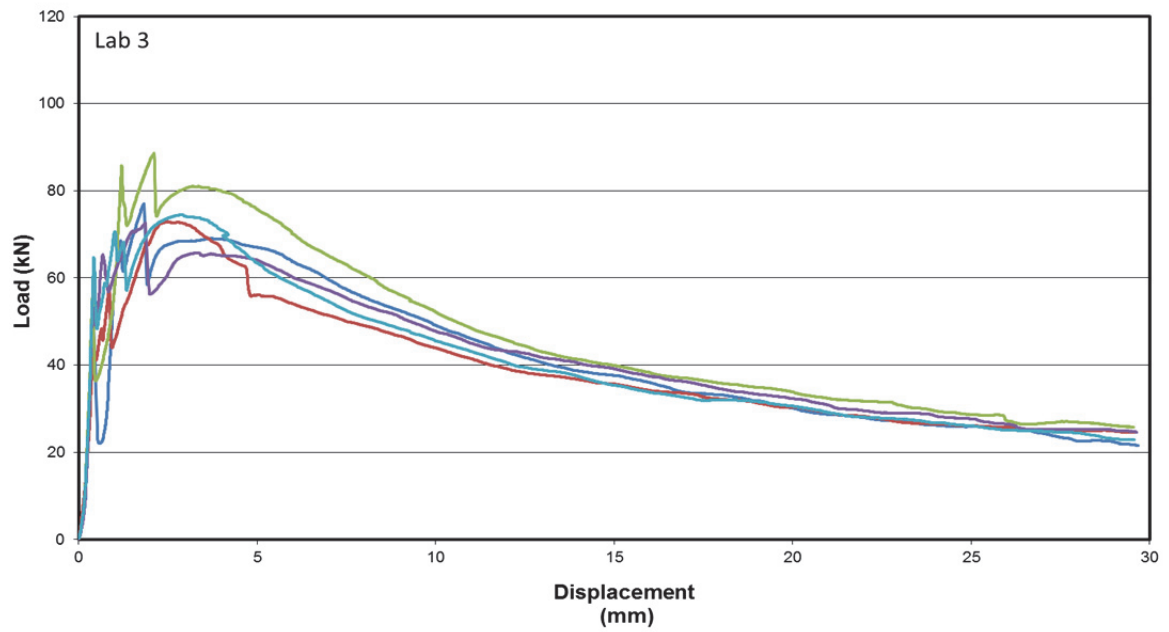

## APPENDIX 3 Pictures of the panels after testing

### Lab 1

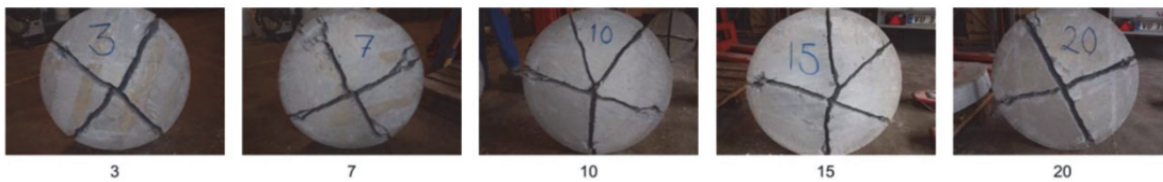

### Lab 3

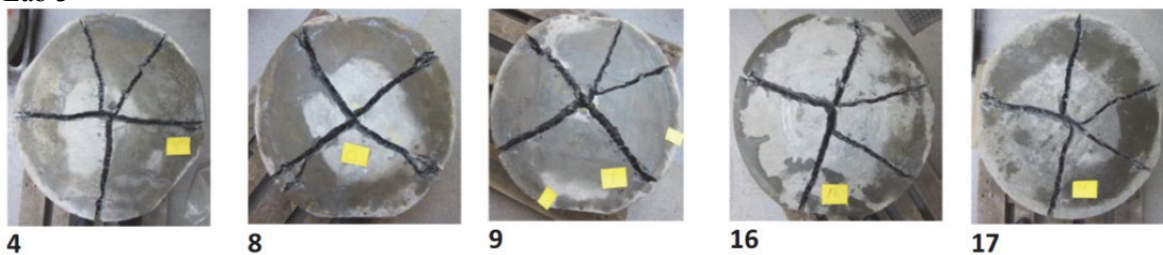

### Lab 4

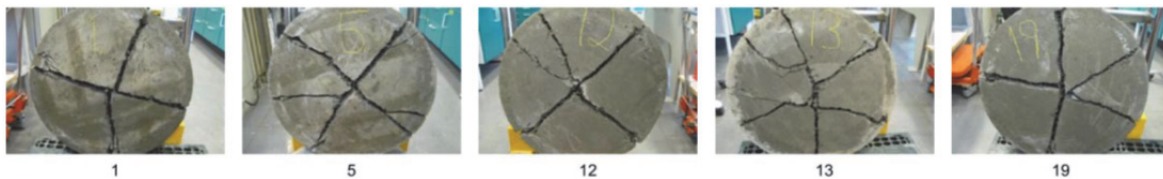

## APPENDIX 4 Outprint from all panel tests

Project: Round Robin / SINTEF-T	Panel production date: 31.03.2011
Specimen ID: Panel 03	
Test date: 30.06.2011	Fibre type: Dramix
Concrete test age (d): 91	Nom. fibre dosage: 30
Comments: 4 cracks	Cast/sprayed: Cast

Type yes/no	Average plate thickness = 99,6 [mm]
Correct for thickness: <b>yes</b>	Nominal plate thickness = 100,0 [mm]
Correct for diameter: <b>no</b>	Average plate diameter = 600,0 [mm]
Correct for early non-linearity: <b>no</b>	Nominal plate diameter = 600,0 [mm]

Corr. factor thickness, $k_t = 1,004$	[-]	Corr. factor diameter, $k_D = 1,000$	[-]
Corr. factor friction, $k_f = 0,750$	[-]		

Displacement [mm]	(corrected) Energy uptake [J]	(corrected) Load [kN]	Relative Energy uptake [J]	Uncorr. Energy	Rel. uncorr/corr
1,0	21	58	0,02		
3,0	122	69	0,16		
5,0	225	68	0,27		
10,0	444	49	0,53		
15,0	604	38	0,72		
20,0	731	30	0,88		
25,0	835	29,1	1,00	1106	132,5 %

Maximum load (corr) = 77,6	[kN]
Displ. at max. load = 1,8	[mm]

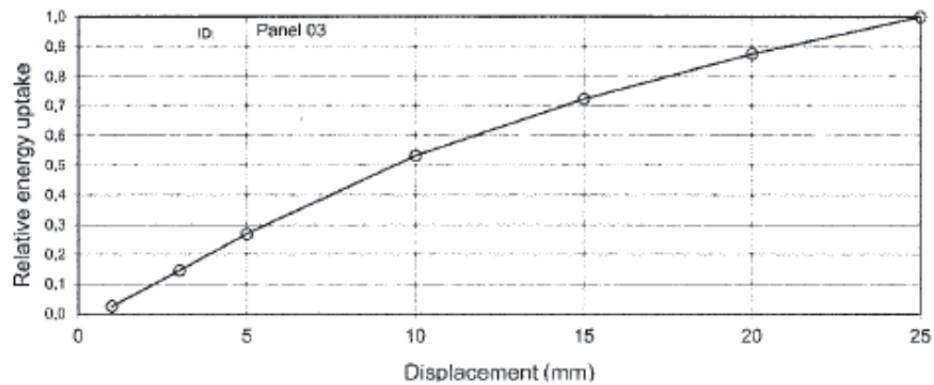
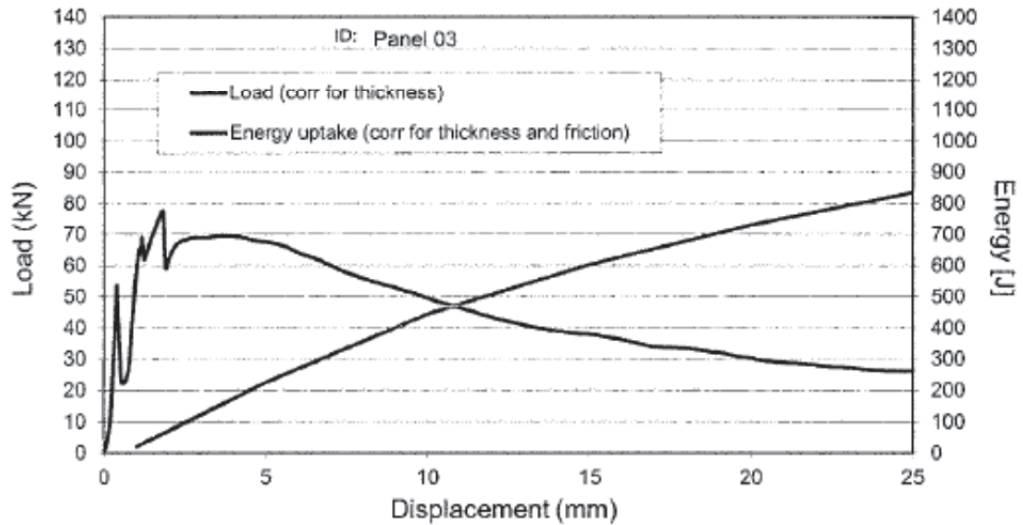

Project: Round Robin / SINTEF T  
 Specimen ID: Panel 7  
 Test date: 30.06.2011  
 Concrete test age (d): 91  
 Comments: 4 Cracks

Panel production date: 31.03.2011

Fibre type: Dramix  
 Nom. fibre dosage: 30  
 Cast/sprayed: Cast

Type yes/no  
 Correct for thickness: **yes**  
 Correct for diameter: **no**  
 Correct for early non-linearity: **no**

Average plate thickness = **101,9** [mm]  
 Nominal plate thickness = 100,0 [mm]  
 Average plate diameter = **600,0** [mm]  
 Nominal plate diameter = 600,0 [mm]

Corr. factor thickness,  $k_h = 0,982$  [-]  
 Corr. factor friction,  $k_f = 0,750$  [-]

Corr. factor diameter,  $k_D = 1,000$  [-]

Displacement [mm]	(corrected) Energy uptake [J]	(corrected) Load [kN]	Relative Energy uptake [J]	Uncorr. Energy	Rel. uncorr/corr
1,0	13	54	0,01		
3,0	132	91	0,14		
5,0	257	77	0,27		
10,0	503	57	0,53		
15,0	688	44	0,72		
20,0	837	36	0,87		
25,0	957	29,3	1,00	1314	137,3 %

Maximum load (corr) = 92,4 [kN]  
 Displ. at max. load = 2,7 [mm]

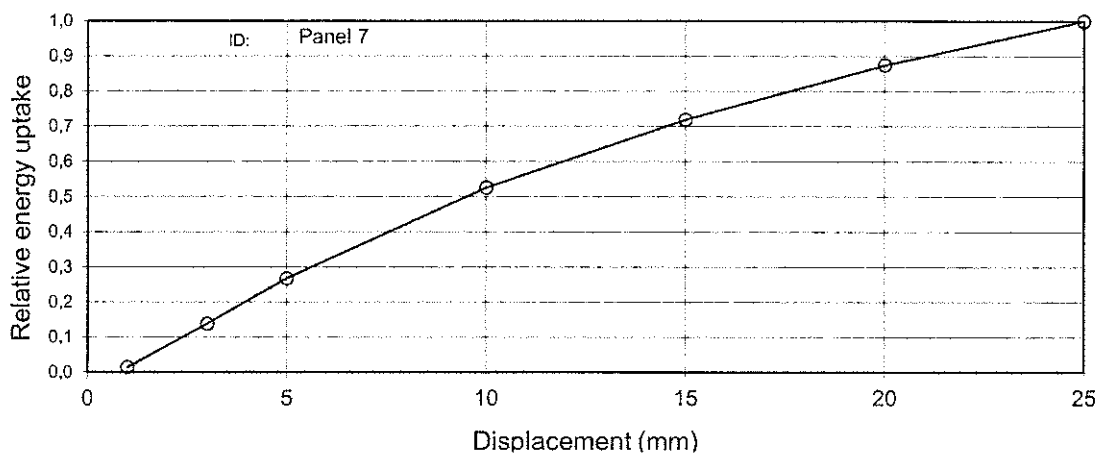
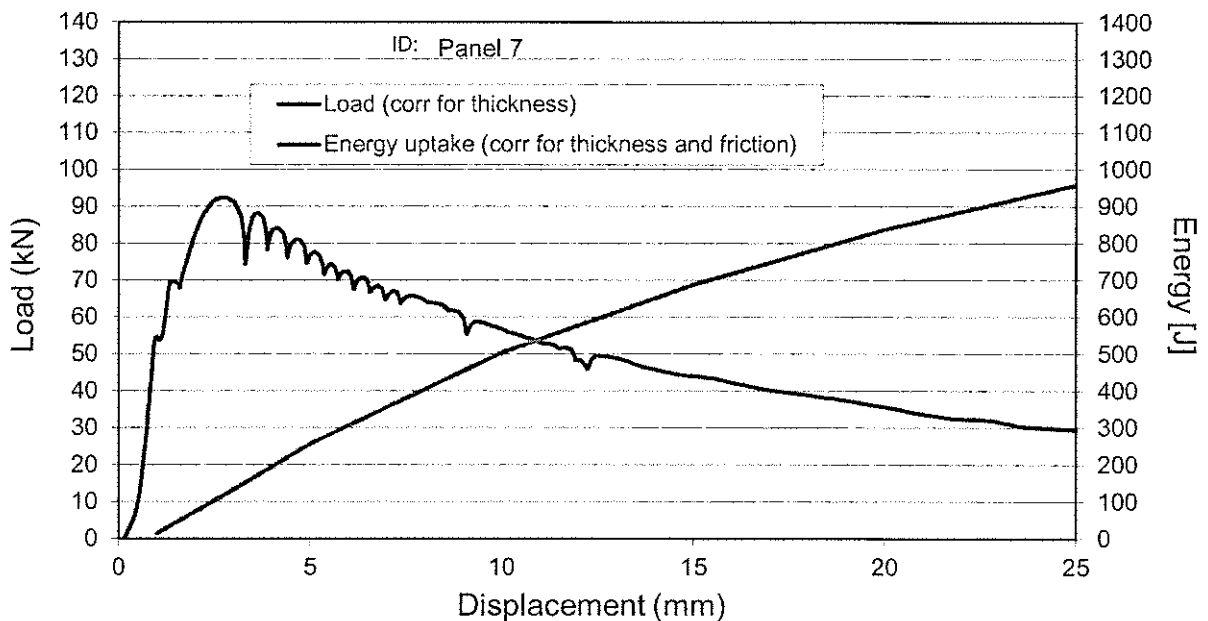



Project: Round Robin / SINTEF T  
 Specimen ID: Panel 10  
 Test date: 30.06.2011  
 Concrete test age (d): 91  
 Comments: 5 Cracks

Panel production date: 31.03.2011

Fibre type: Dramix  
 Nom. fibre dosage: 30  
 Cast/sprayed: Cast

Type yes/no  
 Correct for thickness: **yes**  
 Correct for diameter: **no**  
 Correct for early non-linearity: **no**

Average plate thickness = **102,4** [mm]  
 Nominal plate thickness = 100,0 [mm]  
 Average plate diameter = **600,7** [mm]  
 Nominal plate diameter = 600,0 [mm]

Corr. factor thickness,  $k_h = 0,977$  [-]  
 Corr. factor friction,  $k_f = 0,750$  [-]

Corr. factor diameter,  $k_D = 1,000$  [-]

Displacement [mm]	(corrected) Energy uptake [J]	(corrected) Load [kN]	Relative Energy uptake [J]	Uncorr. Energy	Rel. uncorr/corr
1,0	4	22	0,00		
3,0	106	93	0,11		
5,0	234	74	0,24		
10,0	488	59	0,50		
15,0	685	47	0,71		
20,0	842	38	0,87		
25,0	972	31,6	1,00	1346	138,5 %

Maximum load (corr) = 94,3 [kN]  
 Displ. at max. load = 3,2 [mm]

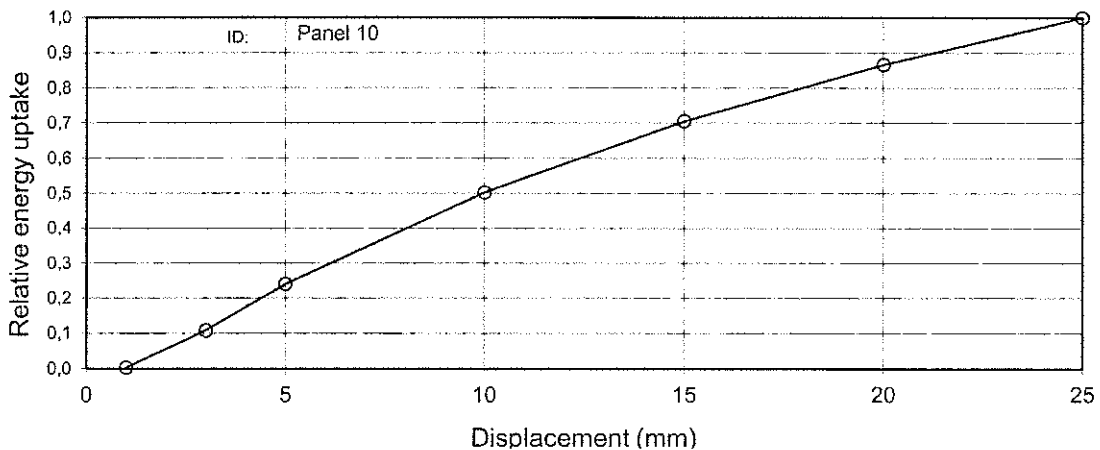
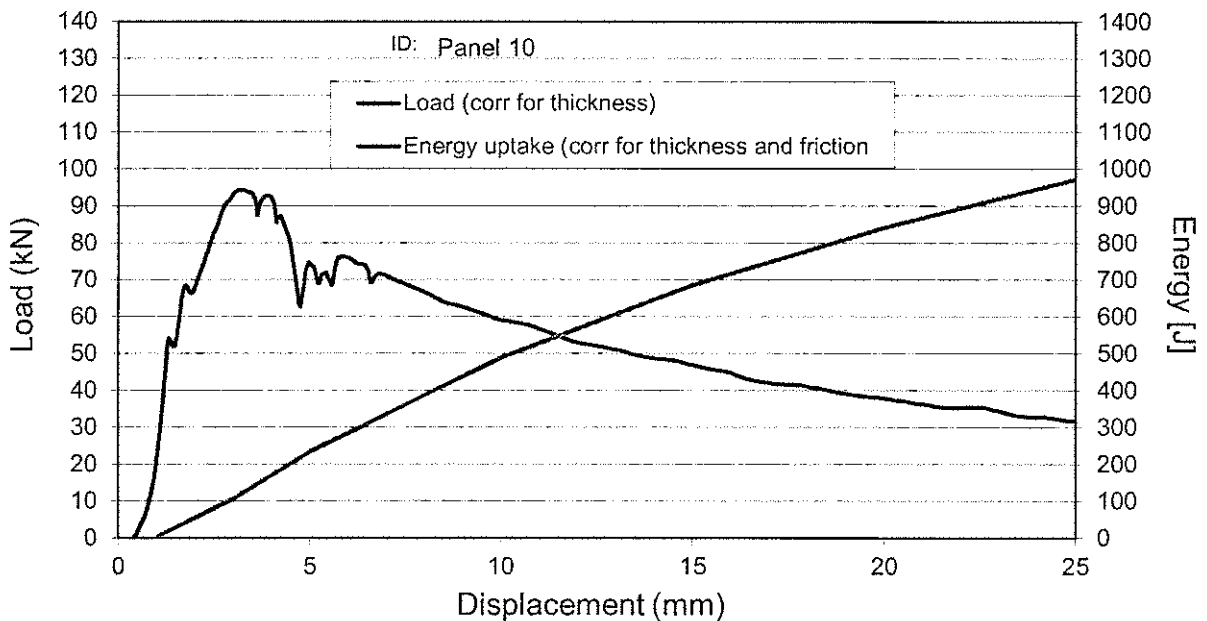

Project: Round Robin / SINTEF T  
 Specimen ID: Panel 15  
 Test date: 30.06.2011  
 Concrete test age (d): 91  
 Comments: 5 Cracks

Panel production date: 31.03.2011

Fibre type: Dramix  
 Nom. fibre dosage: 30  
 Cast/sprayed: Cast

Type yes/no  
 Correct for thickness: **yes**  
 Correct for diameter: **no**  
 Correct for early non-linearity: **no**

Average plate thickness = **102,0** [mm]  
 Nominal plate thickness = 100,0 [mm]  
 Average plate diameter = **600,3** [mm]  
 Nominal plate diameter = 600,0 [mm]

Corr. factor thickness,  $k_h = 0,980$  [-]  
 Corr. factor friction,  $k_f = 0,750$  [-]

Corr. factor diameter,  $k_D = 1,000$  [-]

Displacement [mm]	(corrected) Energy uptake [J]	(corrected) Load [kN]	Relative Energy uptake [J]		
1,0	27	48	0,03		
3,0	117	75	0,14		
5,0	219	64	0,26		
10,0	435	52	0,51		
15,0	608	41	0,71		
20,0	745	32	0,87		
25,0	854	26,6	1,00	Uncorr. Energy	Rel. uncorr/corr
				1175	137,6 %

Maximum load (corr) = 75,0 [kN]  
 Displ. at max. load = 3,0 [mm]

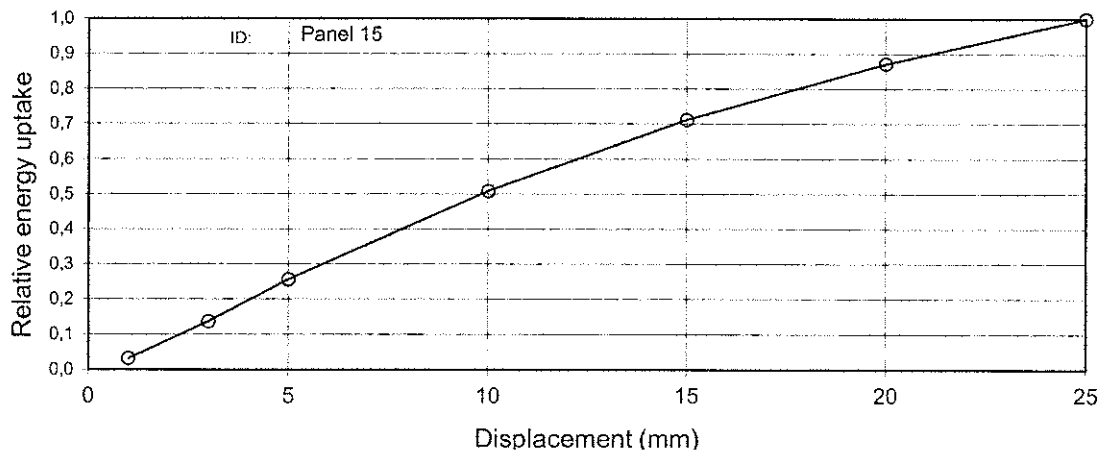
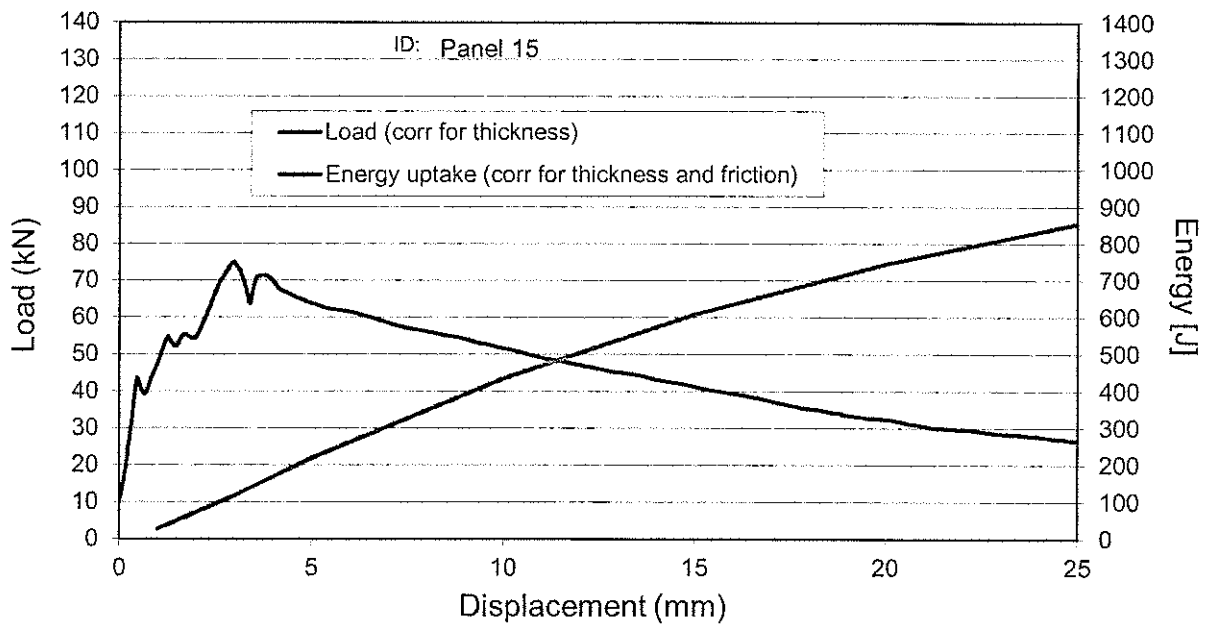

Project: Round Robin / SINTEF T  
 Specimen ID: Panel 20  
 Test date: 30.06.2011  
 Concrete test age (d): 91  
 Comments: 4 Cracks

Panel production date: 31.03.2011

Fibre type: Dramix  
 Nom. fibre dosage: 30  
 Cast/sprayed: Cast

Type yes/no  
 Correct for thickness: **yes**  
 Correct for diameter: **no**  
 Correct for early non-linearity: **no**

Average plate thickness = **101,9** [mm]  
 Nominal plate thickness = 100,0 [mm]  
 Average plate diameter = **595,7** [mm]  
 Nominal plate diameter = 600,0 [mm]

Corr. factor thickness,  $k_h = 0,982$  [-]  
 Corr. factor friction,  $k_f = 0,750$  [-]

Corr. factor diameter,  $k_D = 1,000$  [-]

Displacement [mm]	(corrected) Energy uptake [J]	(corrected) Load [kN]	Relative Energy uptake [J]
1,0	23	39	0,02
3,0	111	76	0,11
5,0	236	84	0,24
10,0	511	61	0,53
15,0	705	44	0,73
20,0	853	35	0,88
25,0	971	28,5	1,00

Uncorr. Energy Rel. uncorr/corr  
1332 137,2 %

Maximum load (corr) = 88,8 [kN]  
 Displ. at max. load = 4,6 [mm]

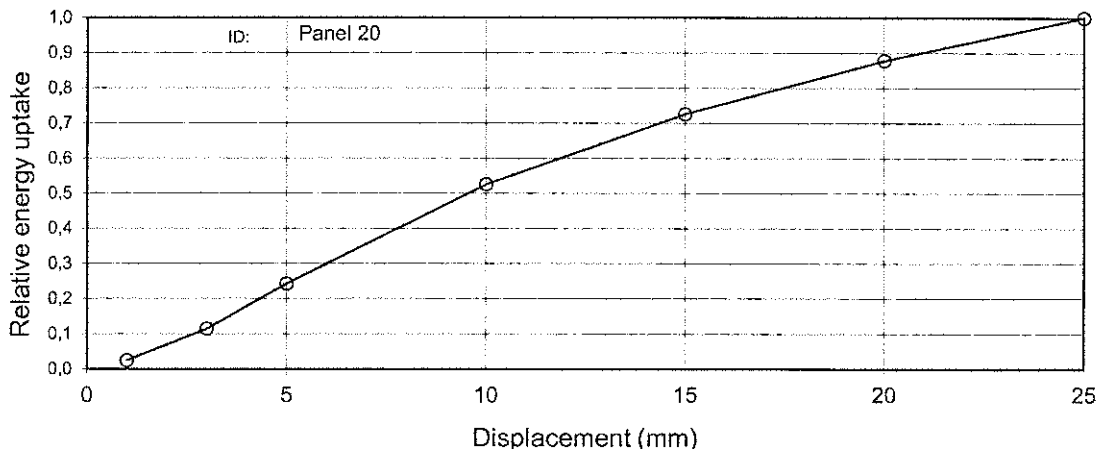
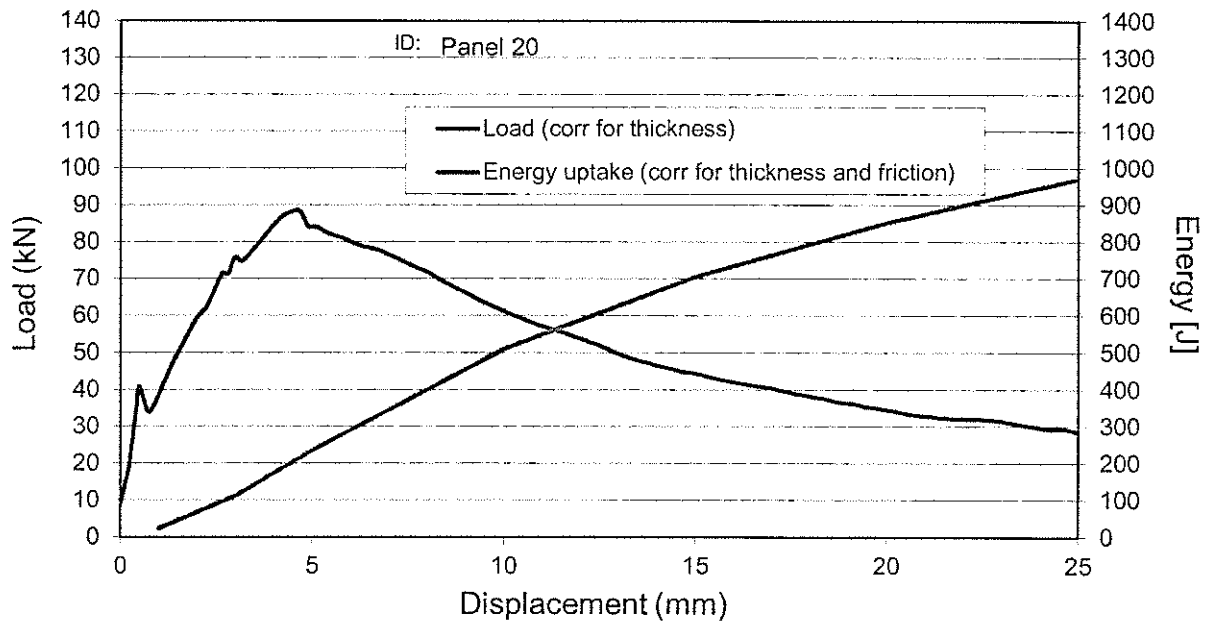

Project: Round Robin / SINTEF-O  
 Specimen ID: Panel 2  
 Test date: 01.07.2011  
 Concrete test age (d): 92  
 Comments:

Panel production date: 31.03.2011

Fibre type: Dramix  
 Nom. fibre dosage: 30  
 Cast/sprayed: Cast

Type yes/no  
 Correct for thickness: **yes**  
 Correct for diameter: **no**  
 Correct for early non-linearity: **no**

Average plate thickness = **99,3** [mm]  
 Nominal plate thickness = 100,0 [mm]  
 Average plate diameter = **601,0** [mm]  
 Nominal plate diameter = 600,0 [mm]

Corr. factor thickness,  $k_h = 1,007$  [-]  
 Corr. factor friction,  $k_f = 0,750$  [-]

Corr. factor diameter,  $k_D = 1,000$  [-]

Displacement [mm]	(corrected) Energy uptake [J]	(corrected) Load [kN]	Relative Energy uptake [J]	Uncorr. Energy	Rel. uncorr/corr
1,0	43	71	0,05		
3,0	144	69	0,17		
5,0	244	63	0,28		
10,0	452	49	0,52		
15,0	616	39	0,72		
20,0	748	32	0,87		
25,0	860	27,8	1,00	1135	131,9 %

Maximum load (corr) = 77,5 [kN]  
 Displ. at max. load = 0,9 [mm]

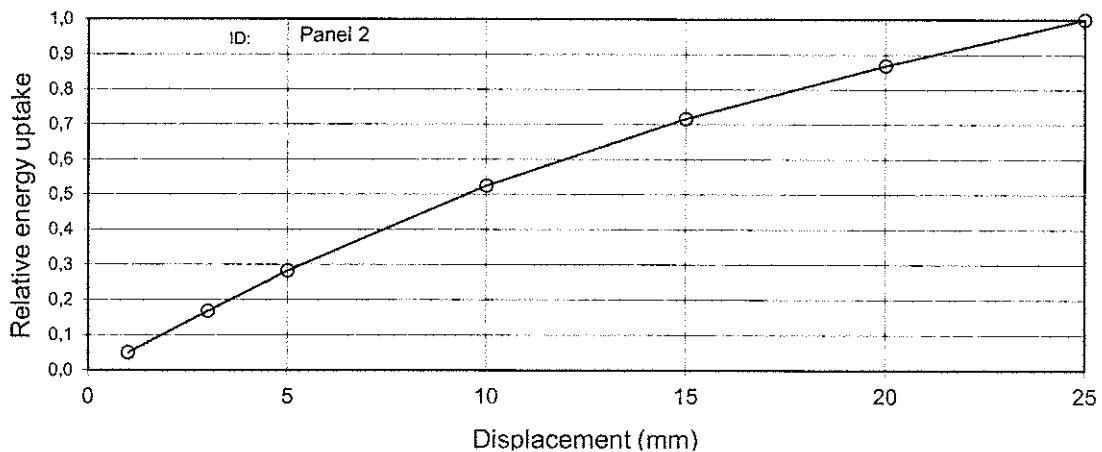
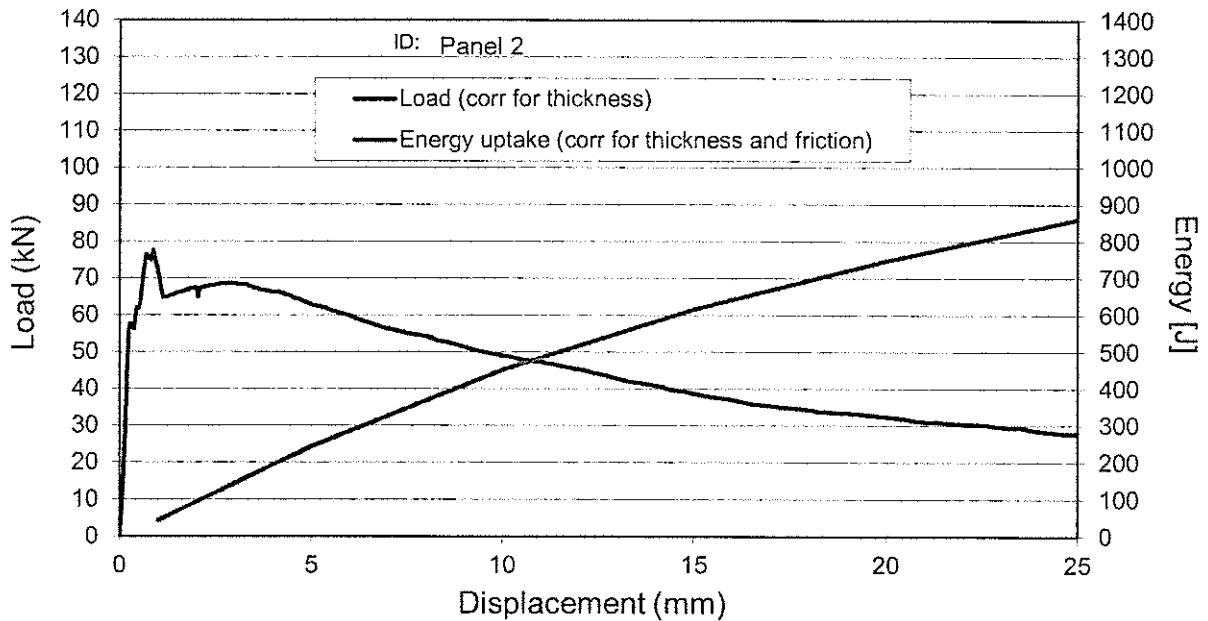

Project: Round Robin / SINETF-O  
 Specimen ID: Panel 6  
 Test date: 01.07.2011  
 Concrete test age (d): 92  
 Comments:

Panel production date: 31.03.2011

Fibre type: Dramix  
 Nom. fibre dosage: 30  
 Cast/sprayed: Cast

Type yes/no  
 Correct for thickness: **yes**  
 Correct for diameter: **no**  
 Correct for early non-linearity: **no**

Average plate thickness = **100,8** [mm]  
 Nominal plate thickness = 100,0 [mm]  
 Average plate diameter = **600,3** [mm]  
 Nominal plate diameter = 600,0 [mm]

Corr. factor thickness,  $k_h = 0,992$  [-]  
 Corr. factor friction,  $k_f = 0,750$  [-]

Corr. factor diameter,  $k_D = 1,000$  [-]

Displacement [mm]	(corrected) Energy uptake [J]	(corrected) Load [kN]	Relative Energy uptake [J]	Uncorr. Energy	Rel. uncorr/corr
1,0	44	72	0,05		
3,0	144	66	0,17		
5,0	241	63	0,28		
10,0	452	48	0,53		
15,0	614	39	0,72		
20,0	744	31	0,87		
25,0	854	28,0	1,00	1154	135,1 %

Maximum load (corr) = 74,8 [kN]  
 Displ. at max. load = 1,5 [mm]

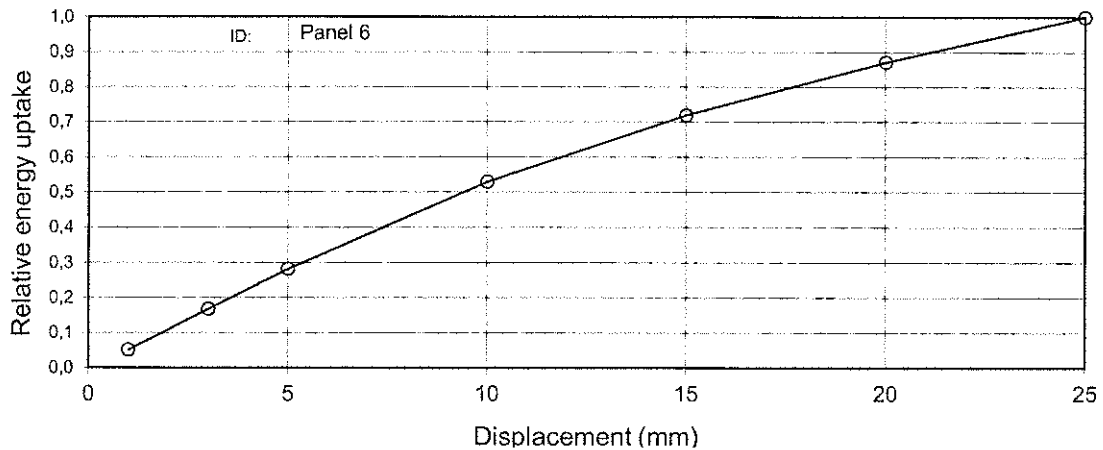
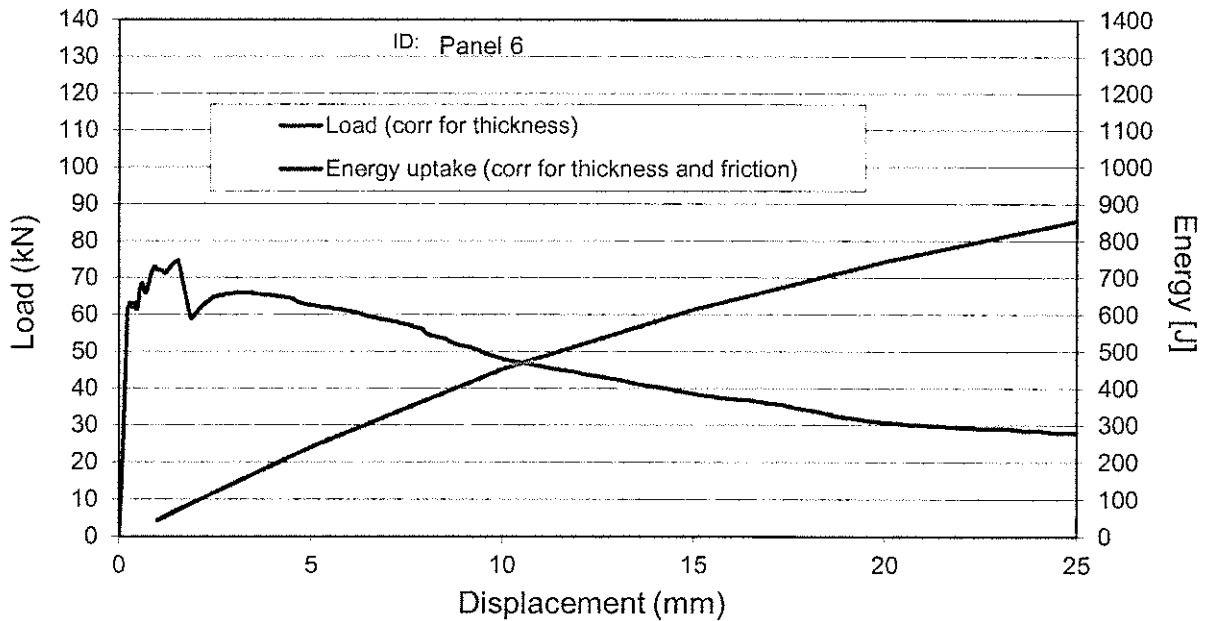

Project: Round Robin / SINTEF-O  
 Specimen ID: Panel 11  
 Test date: 01.07.2011  
 Concrete test age (d): 92  
 Comments:

Panel production date: 31.03.2011

Fibre type: Dramix  
 Nom. fibre dosage: 30  
 Cast/sprayed: Cast

Type yes/no  
 Correct for thickness: **yes**  
 Correct for diameter: **no**  
 Correct for early non-linearity: **no**

Average plate thickness = **103,0** [mm]  
 Nominal plate thickness = 100,0 [mm]  
 Average plate diameter = **599,7** [mm]  
 Nominal plate diameter = 600,0 [mm]

Corr. factor thickness,  $k_h = 0,971$  [-]  
 Corr. factor friction,  $k_f = 0,750$  [-]

Corr. factor diameter,  $k_D = 1,000$  [-]

Displacement [mm]	(corrected) Energy uptake [J]	(corrected) Load [kN]	Relative Energy uptake [J]	Uncorr. Energy	Rel. uncorr/corr
1,0	41	85	0,04		
3,0	177	93	0,17		
5,0	304	71	0,29		
10,0	550	59	0,53		
15,0	749	47	0,72		
20,0	907	38	0,87		
25,0	1038	32,4	1,00	1451	139,7 %

Maximum load (corr) = 94,5 [kN]  
 Displ. at max. load = 1,2 [mm]

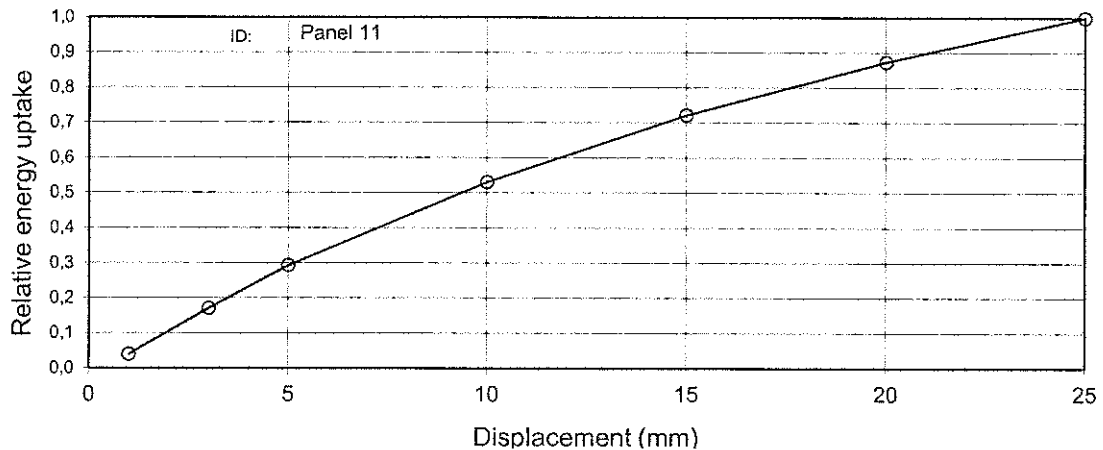
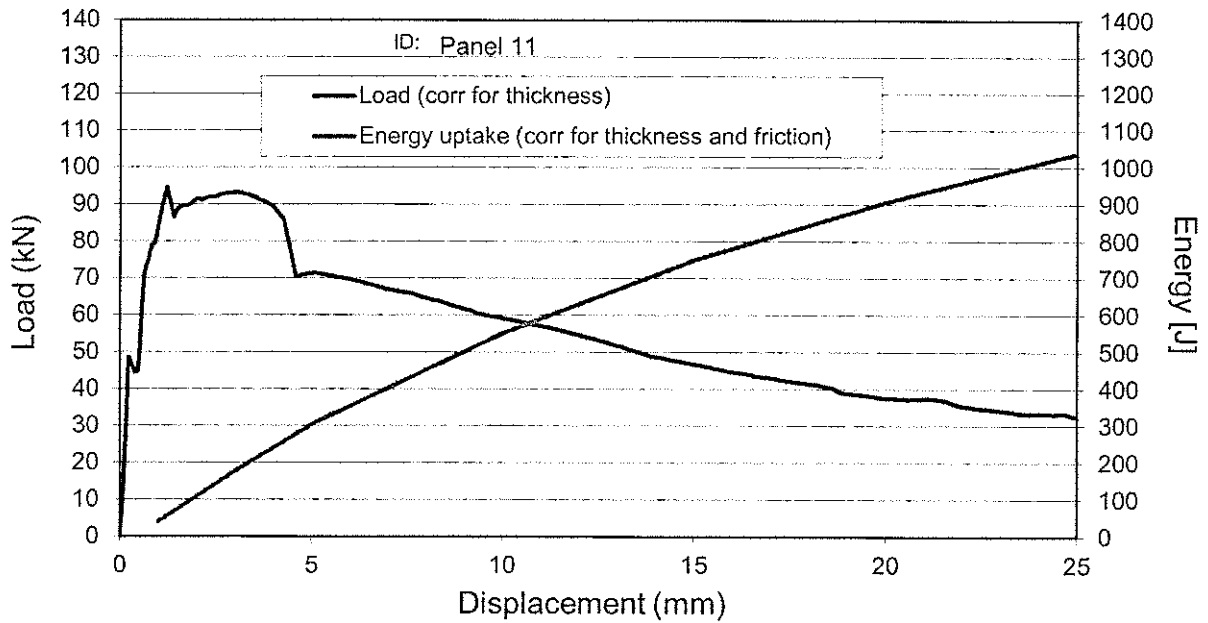

Project: Round Robin / SINTEF-O  
 Specimen ID: Panel 14  
 Test date: 01.07.2011  
 Concrete test age (d): 92  
 Comments:

Panel production date: 31.03.2011

Fibre type: Dramix  
 Nom. fibre dosage: 30  
 Cast/sprayed: Cast

Type yes/no  
 Correct for thickness: **yes**  
 Correct for diameter: **no**  
 Correct for early non-linearity: **no**

Average plate thickness = **102,6** [mm]  
 Nominal plate thickness = 100,0 [mm]  
 Average plate diameter = **599,0** [mm]  
 Nominal plate diameter = 600,0 [mm]

Corr. factor thickness,  $k_h = 0,975$  [-]  
 Corr. factor friction,  $k_f = 0,750$  [-]

Corr. factor diameter,  $k_D = 1,000$  [-]

Displacement [mm]	(corrected) Energy uptake [J]	(corrected) Load [kN]	Relative Energy uptake [J]	Uncorr. Energy	Rel. uncorr/corr
1,0	28	54	0,04		
3,0	126	66	0,16		
5,0	222	62	0,27		
10,0	418	46	0,52		
15,0	576	38	0,71		
20,0	707	32	0,87		
25,0	811	25,4	1,00	1127	138,9 %

Maximum load (corr) = 69,6 [kN]  
 Displ. at max. load = 1,8 [mm]

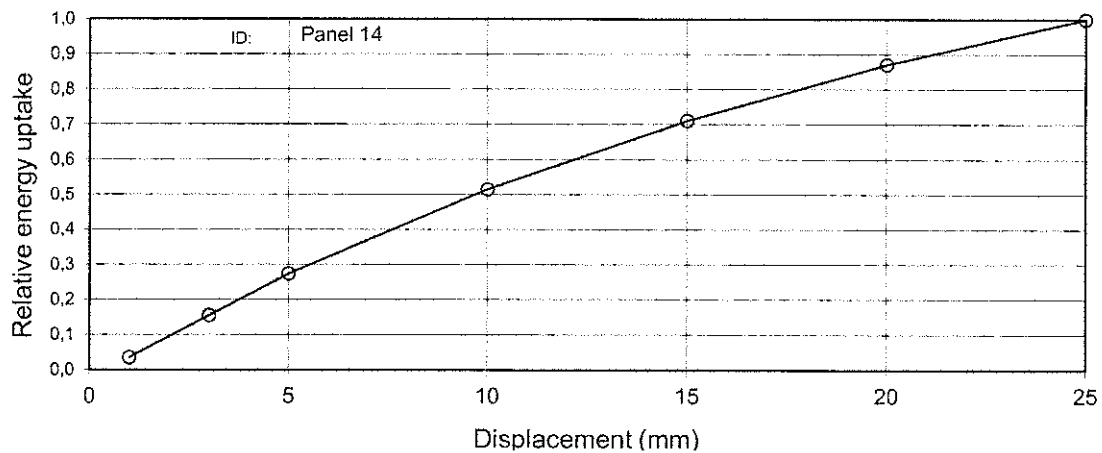
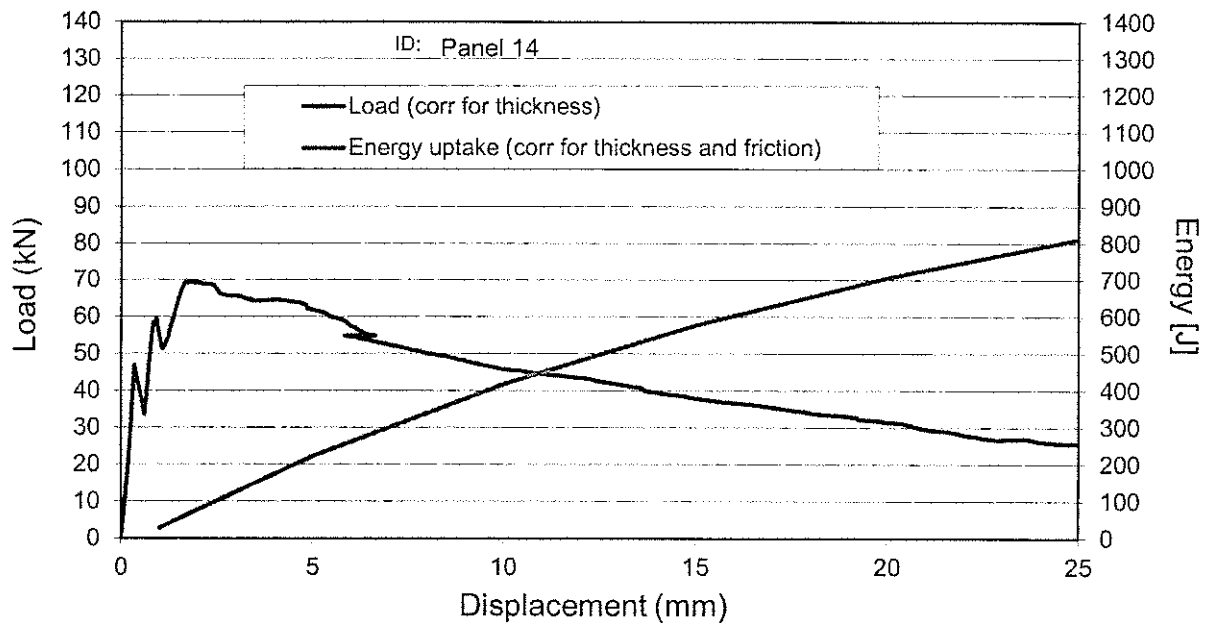

Project: Round Robin / SINTEF-O  
 Specimen ID: Panel 18  
 Test date: 01.07.2011  
 Concrete test age (d): 92  
 Comments:

Panel production date: 31.03.2011

Fibre type: Dramix  
 Nom. fibre dosage: 30  
 Cast/sprayed: Cast

Type yes/no  
 Correct for thickness: **yes**  
 Correct for diameter: **no**  
 Correct for early non-linearity: **no**

Average plate thickness = **106,3** [mm]  
 Nominal plate thickness = 100,0 [mm]  
 Average plate diameter = **597,3** [mm]  
 Nominal plate diameter = 600,0 [mm]

Corr. factor thickness,  $k_h = 0,940$  [-]  
 Corr. factor friction,  $k_f = 0,750$  [-]

Corr. factor diameter,  $k_D = 1,000$  [-]

Displacement [mm]	(corrected) Energy uptake [J]	(corrected) Load [kN]	Relative Energy uptake [J]	Uncorr. Energy	Rel. uncorr/corr
1,0	23	38	0,03		
3,0	109	66	0,14		
5,0	212	67	0,28		
10,0	411	44	0,54		
15,0	554	33	0,73		
20,0	663	27	0,88		
25,0	757	23,4	1,00	1112	146,8 %

Maximum load (corr) = 69,6 [kN]  
 Displ. at max. load = 4,2 [mm]

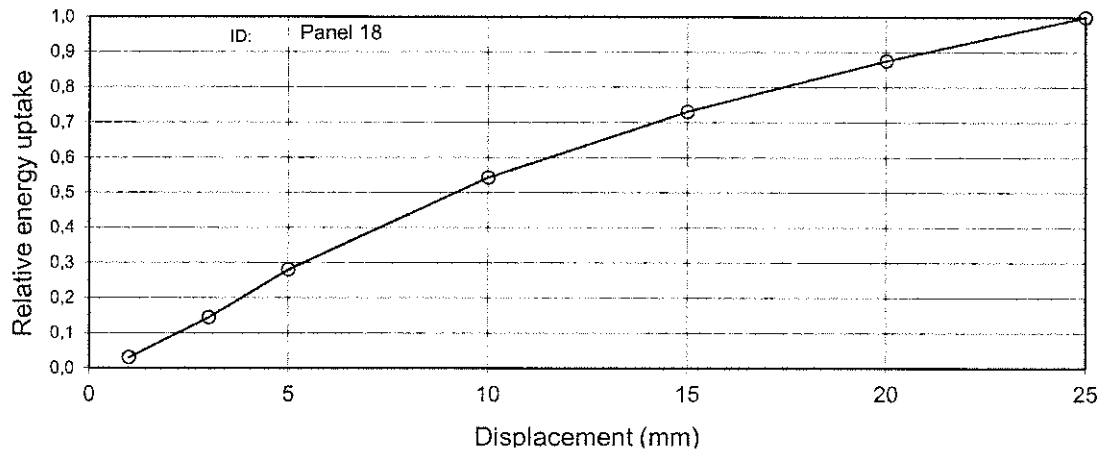
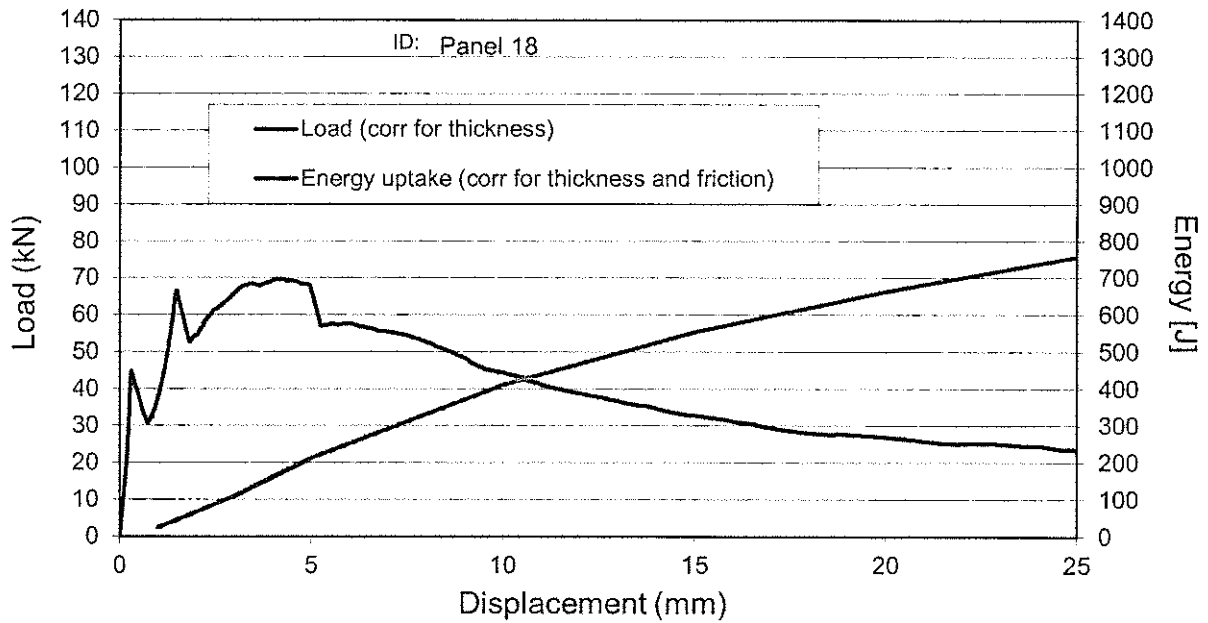



Project: Round Robin / SINTEF-O

Panel production date: 31.03.2011

Specimen ID: Panel 21

Test date: 01.07.2011

Fibre type: Dramix

Concrete test age (d): 92

Nom. fibre dosage: 30

Comments: NOT PART OF EVALUATION

Cast/sprayed: Cast

Type yes/no  
 Correct for thickness: **yes**  
 Correct for diameter: **no**  
 Correct for early non-linearity: **no**

Average plate thickness = **82,7** [mm]  
 Nominal plate thickness = 100,0 [mm]  
 Average plate diameter = **596,3** [mm]  
 Nominal plate diameter = 600,0 [mm]

Corr. factor thickness,  $k_h = 1,210$  [-]

Corr. factor diameter,  $k_D = 1,000$  [-]

Corr. factor friction,  $k_f = 0,750$  [-]

Displacement [mm]	(corrected) Energy uptake [J]	(corrected) Load [kN]	Relative Energy uptake [J]	Uncorr. Energy	Rel. uncorr/corr
1,0	36	56	0,04		
3,0	143	67	0,16		
5,0	244	67	0,28		
10,0	467	51	0,54		
15,0	634	37	0,73		
20,0	761	31	0,88		
25,0	868	26,6	1,00	855	98,6 %

Maximum load (corr) = 79,3 [kN]  
 Displ. at max. load = 2,7 [mm]

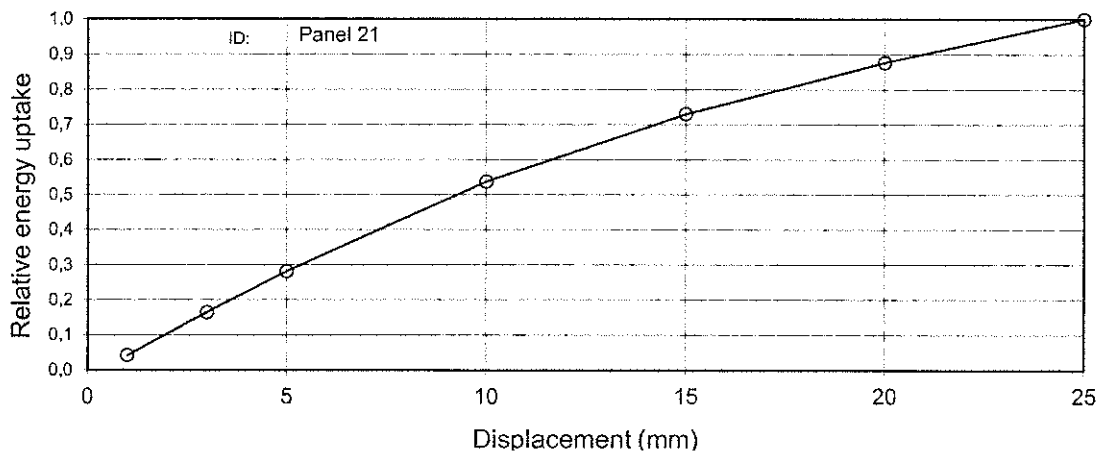
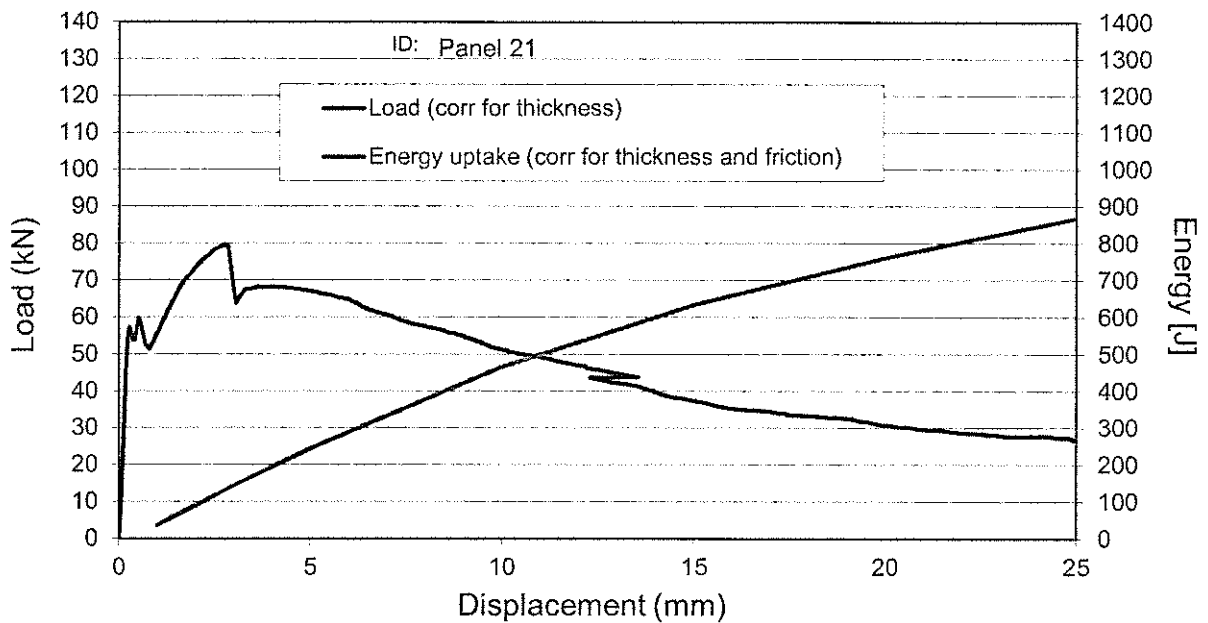

Project: Round Robin / MANNVIT

Panel production date: 31.03.2011

Specimen ID: Panel 04

Test date: 30.06.2011

Fibre type: Dramix

Concrete test age (d): 91

Nom. fibre dosage: 30

Comments: max gap between plate and steelring: 0,8mm. A tria Cast/sprayed: Cast

Type yes/no  
 Correct for thickness: **yes**  
 Correct for diameter: **no**  
 Correct for early non-linearity: **no**

Average plate thickness = **99,8** [mm]  
 Nominal plate thickness = 100,0 [mm]  
 Average plate diameter = **600,7** [mm]  
 Nominal plate diameter = 600,0 [mm]

Corr. factor thickness,  $k_h = 1,002$  [-]

Corr. factor diameter,  $k_D = 1,000$  [-]

Corr. factor friction,  $k_f = 0,750$  [-]

Displacement [mm]	(corrected) Energy uptake [J]	(corrected) Load [kN]	Relative Energy uptake [J]	Uncorr. Energy	Rel. uncorr/corr
1,0	21	57	0,02		
3,0	121	69	0,15		
5,0	224	67	0,27		
10,0	442	49	0,53		
15,0	601	38	0,72		
20,0	728	30	0,88		
25,0	832	26,0	1,00	1106	133,0 %

Maximum load (corr) = 77,3 [kN]  
 Displ. at max. load = 1,8 [mm]

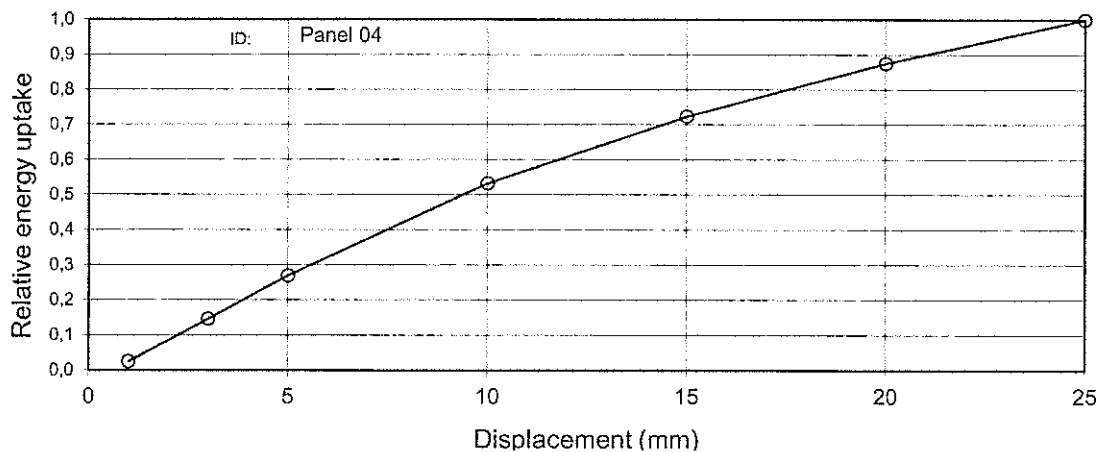
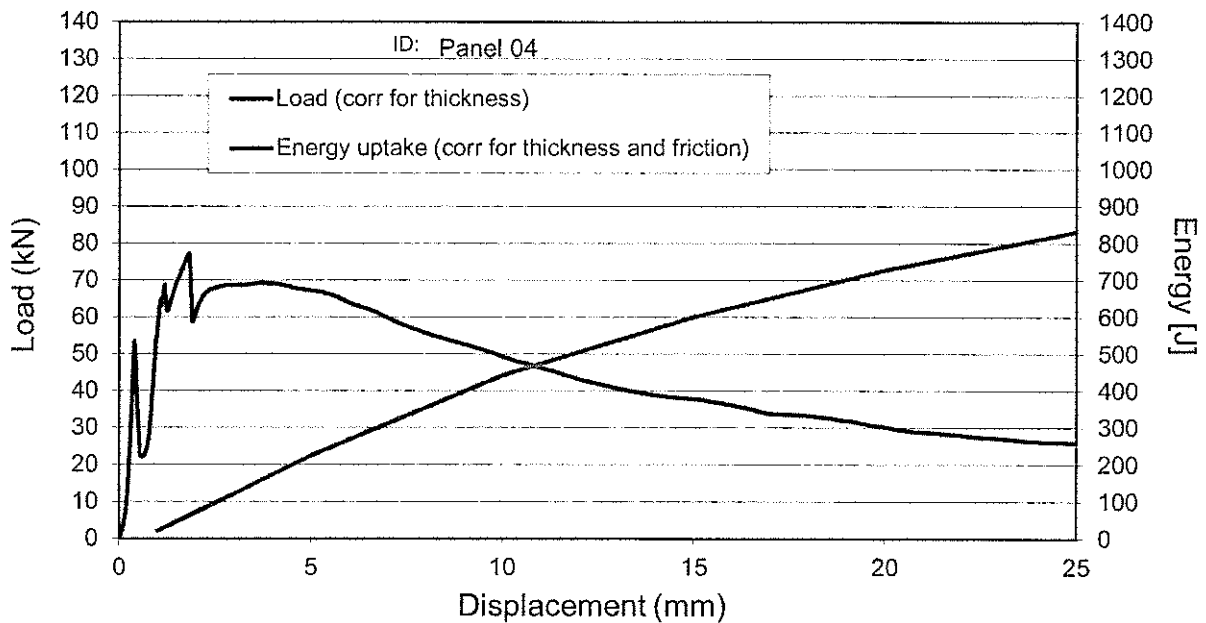

Project: Round Robin / MANNVIT

Panel production date: 31.03.2011

Specimen ID: Panel 08

Test date: 30.06.2011

Fibre type: Dramix

Concrete test age (d): 91

Nom. fibre dosage: 30

Comments: max gap between plate and steelring: 0 mm. A trian Cast/sprayed: Cast

Type yes/no  
 Correct for thickness: **yes**  
 Correct for diameter: **no**  
 Correct for early non-linearity: **no**

Average plate thickness = **101,8** [mm]  
 Nominal plate thickness = 100,0 [mm]  
 Average plate diameter = **600,0** [mm]  
 Nominal plate diameter = 600,0 [mm]

Corr. factor thickness,  $k_h = 0,982$  [-]

Corr. factor diameter,  $k_D = 1,000$  [-]

Corr. factor friction,  $k_f = 0,750$  [-]

Displacement [mm]	(corrected) Energy uptake [J]	(corrected) Load [kN]	Relative Energy uptake [J]	Uncorr. Energy	Rel. uncorr/corr
1,0	25	43	0,03		
3,0	119	70	0,16		
5,0	215	54	0,28		
10,0	398	43	0,52		
15,0	540	35	0,71		
20,0	660	29	0,87		
25,0	762	25,3	1,00	1046	137,3 %

Maximum load (corr) = 70,3 [kN]  
 Displ. at max. load = 2,5 [mm]

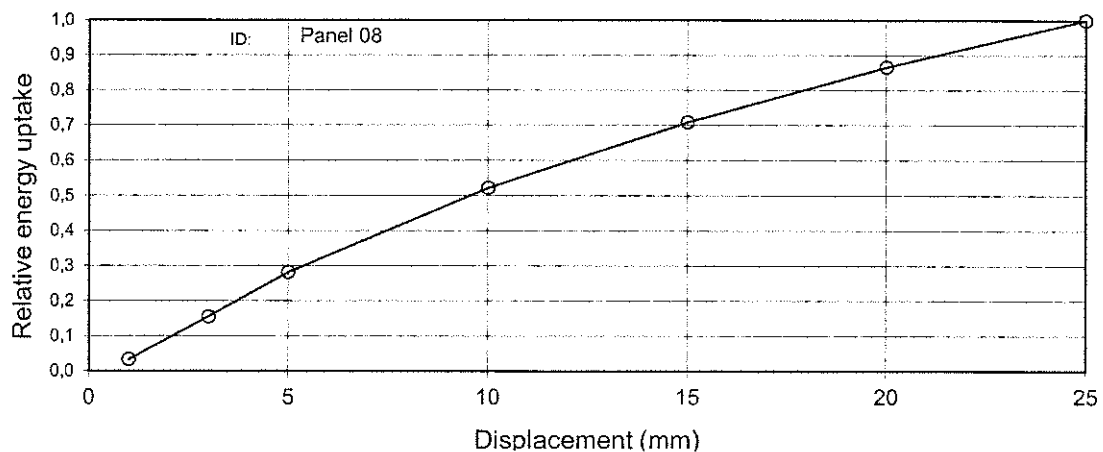
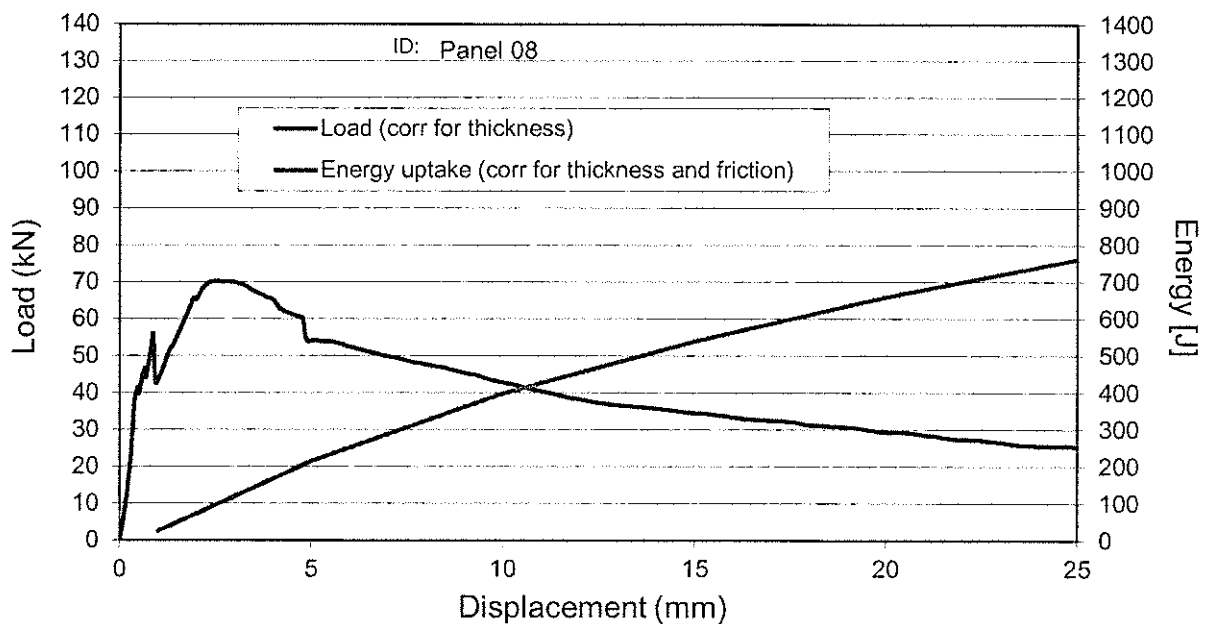

Project: Round Robin / MANNVIT

Panel production date: 31.03.2011

Specimen ID: Panel 09

Test date: 30.06.2011

Fibre type: Dramix

Concrete test age (d): 91

Nom. fibre dosage: 30

Comments: max gap between plate and steeling: 1,2mm. A tria Cast/sprayed: Cast

Type yes/no  
 Correct for thickness: **yes**  
 Correct for diameter: **no**  
 Correct for early non-linearity: **no**

Average plate thickness = **102,7** [mm]  
 Nominal plate thickness = 100,0 [mm]  
 Average plate diameter = **601,7** [mm]  
 Nominal plate diameter = 600,0 [mm]

Corr. factor thickness,  $k_h = 0,974$  [-]

Corr. factor diameter,  $k_D = 1,000$  [-]

Corr. factor friction,  $k_f = 0,750$  [-]

Displacement [mm]	(corrected) Energy uptake [J]	(corrected) Load [kN]	Relative Energy uptake [J]	Uncorr. Energy	Rel. uncorr/corr
1,0	24	52	0,03		
3,0	135	76	0,15		
5,0	249	73	0,28		
10,0	477	51	0,54		
15,0	639	38	0,72		
20,0	771	33	0,87		
25,0	884	27,7	1,00	1229	139,0 %

Maximum load (corr) = 84,2 [kN]

Displ. at max. load = 2,2 [mm]

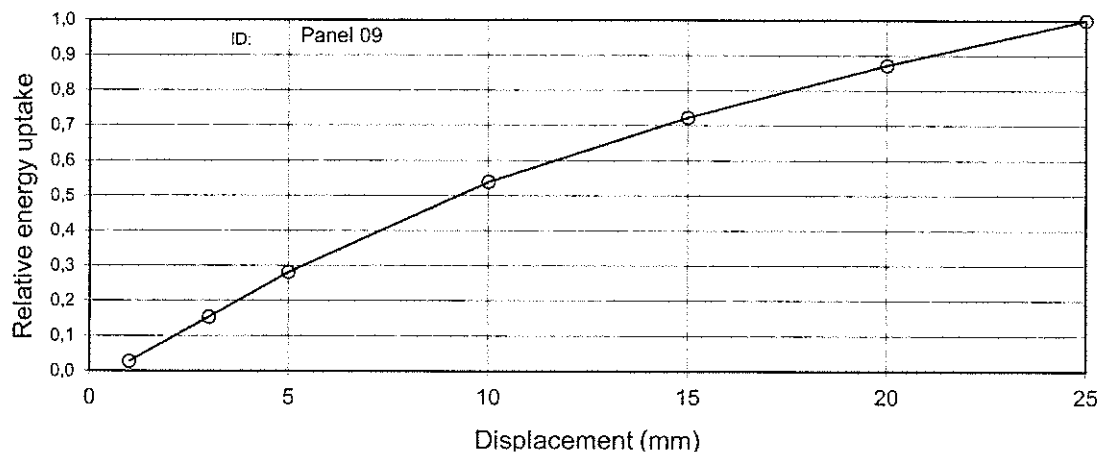
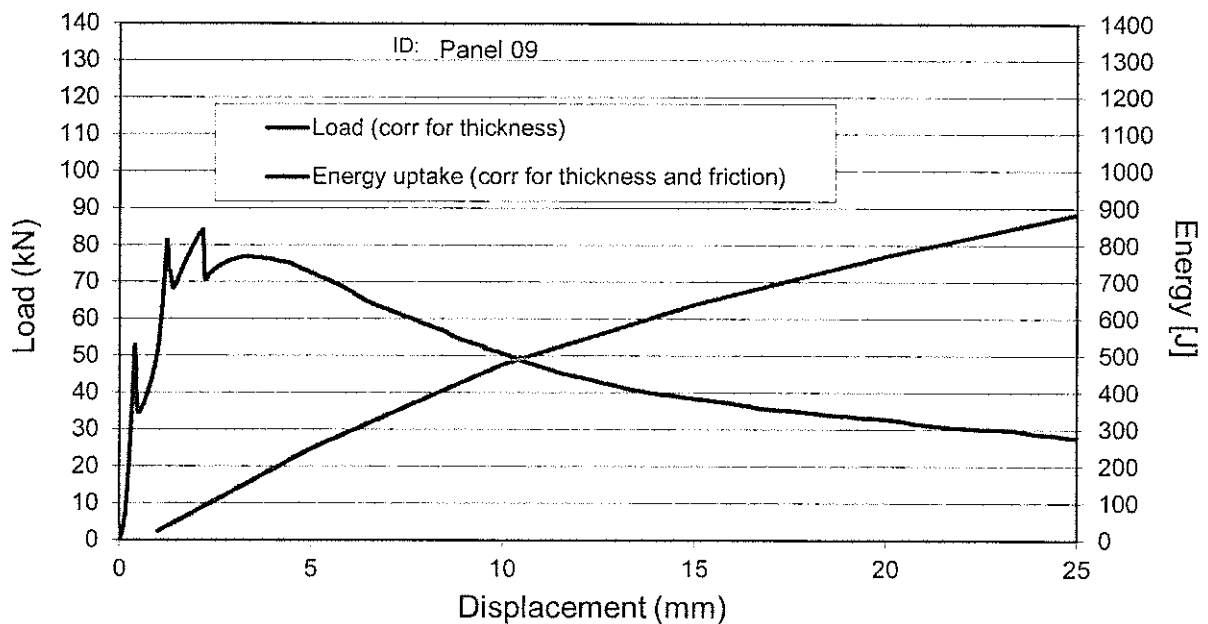

Project: Round Robin / MANNVIT

Panel production date: 31.03.2011

Specimen ID: Panel 16

Test date: 30.06.2011

Fibre type: Dramix

Concrete test age (d): 91

Nom. fibre dosage: 30

Comments: max gap between plate and steelring: 0,4mm. A tria Cast/sprayed: Cast

Type yes/no		Average plate thickness = <b>100,2</b>	[mm]
Correct for thickness: <b>yes</b>		Nominal plate thickness = 100,0	[mm]
Correct for diameter: <b>no</b>			
Correct for early non-linearity: <b>no</b>		Average plate diameter = <b>599,0</b>	[mm]
		Nominal plate diameter = 600,0	[mm]

Corr. factor thickness, $k_h = 0,998$	[-]	Corr. factor diameter, $k_D = 1,000$	[-]
Corr. factor friction, $k_f = 0,750$	[-]		

Displacement [mm]	(corrected) Energy uptake [J]	(corrected) Load [kN]	Relative Energy uptake [J]	Uncorr. Energy	Rel. uncorr/corr
1,0	31	61	0,04		
3,0	127	65	0,15		
5,0	225	64	0,27		
10,0	433	48	0,52		
15,0	593	39	0,71		
20,0	725	32	0,87		
25,0	836	27,6	1,00	1118	133,7 %

Maximum load (corr) = 72,3	[kN]
Displ. at max. load = 1,9	[mm]

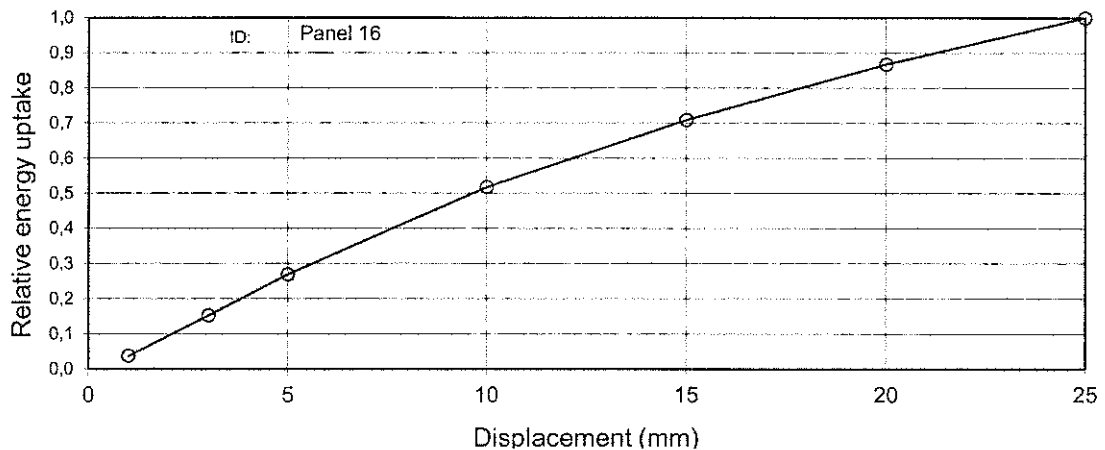
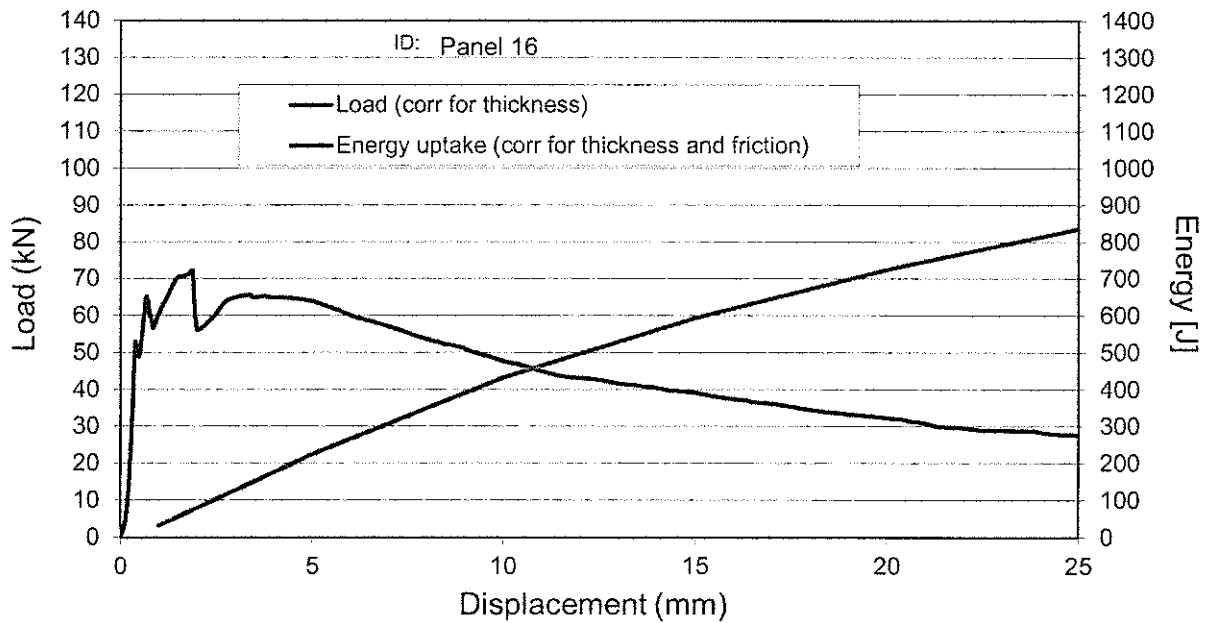

Project: Round Robin / MANNVIT  
 Specimen ID: Panel 17

Panel production date: 31.03.2011

Test date: 30.06.2011

Fibre type: Dramix

Concrete test age (d): 91

Nom. fibre dosage: 30

Comments: max gap between plate and steelring: 0,6mm. A tria Cast/sprayed: Cast

Type yes/no  
 Correct for thickness: **yes**  
 Correct for diameter: **no**  
 Correct for early non-linearity: **no**

Average plate thickness = **101,2** [mm]  
 Nominal plate thickness = 100,0 [mm]  
 Average plate diameter = **596,3** [mm]  
 Nominal plate diameter = 600,0 [mm]

Corr. factor thickness,  $k_h = 0,988$  [-]  
 Corr. factor friction,  $k_f = 0,750$  [-]

Corr. factor diameter,  $k_D = 1,000$  [-]

Displacement [mm]	(corrected) Energy uptake [J]	(corrected) Load [kN]	Relative Energy uptake [J]	Uncorr. Energy	Rel. uncorr/corr
1,0	31	68	0,04		
3,0	133	72	0,17		
5,0	236	62	0,29		
10,0	433	45	0,54		
15,0	580	35	0,72		
20,0	700	30	0,87		
25,0	804	25,6	1,00	1092	135,8 %

Maximum load (corr) = 72,8 [kN]  
 Displ. at max. load = 2,9 [mm]

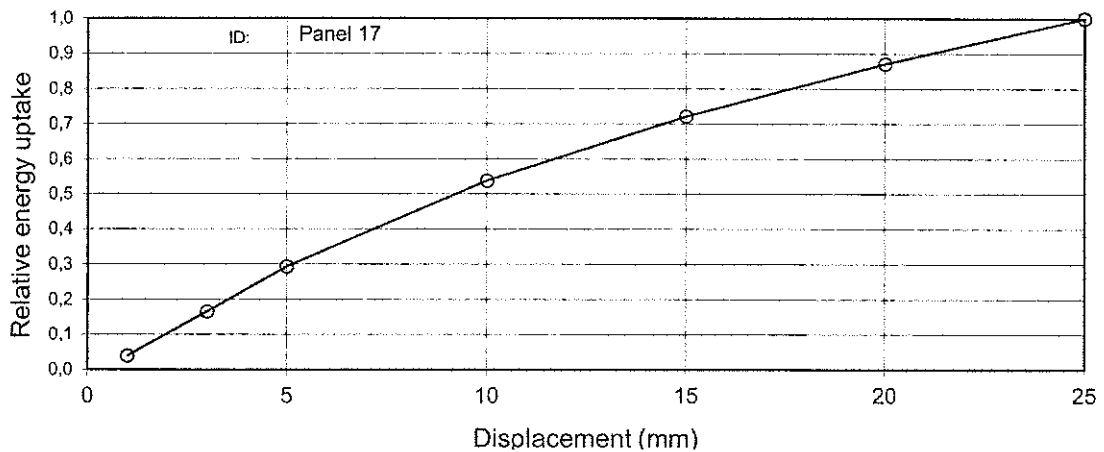
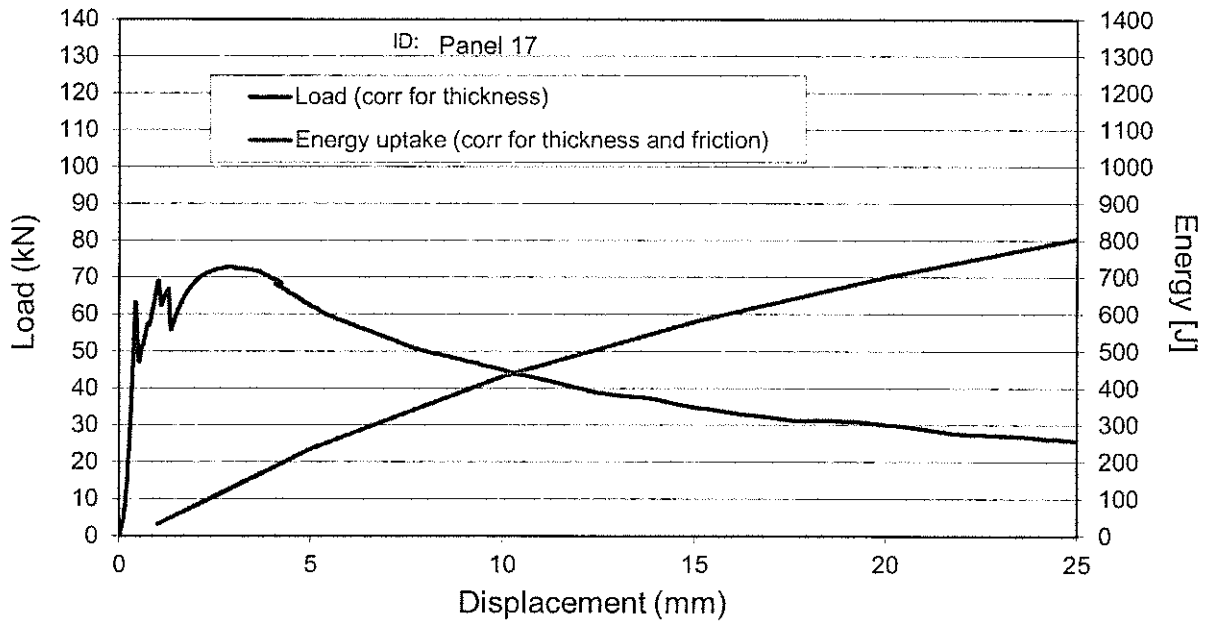

Project: Round Robin / NPRA  
 Specimen ID: Panel 1  
 Test date: 29.06.2011  
 Concrete test age (d): 90  
 Comments:

Panel production date: 31.03.2011

Fibre type: Dramix  
 Nom. fibre dosage: 30  
 Cast/sprayed: Cast

Type yes/no  
 Correct for thickness: **yes**  
 Correct for diameter: **no**  
 Correct for early non-linearity: **no**

Average plate thickness = **101,6** [mm]  
 Nominal plate thickness = 100,0 [mm]  
 Average plate diameter = **601,3** [mm]  
 Nominal plate diameter = 600,0 [mm]

Corr. factor thickness,  $k_h = 0,984$  [-]  
 Corr. factor friction,  $k_f = 0,750$  [-]

Corr. factor diameter,  $k_D = 1,000$  [-]

Displacement [mm]	(corrected) Energy uptake [J]	(corrected) Load [kN]	Relative Energy uptake [J]	Uncorr. Energy	Rel. uncorr/corr
1,0	15	55	0,02		
3,0	123	77	0,15		
5,0	235	69	0,29		
10,0	449	47	0,55		
15,0	602	35	0,73		
20,0	719	29	0,88		
25,0	820	25,2	1,00	1121	136,7 %

Maximum load (corr) = 77,3 [kN]  
 Displ. at max. load = 2,7 [mm]

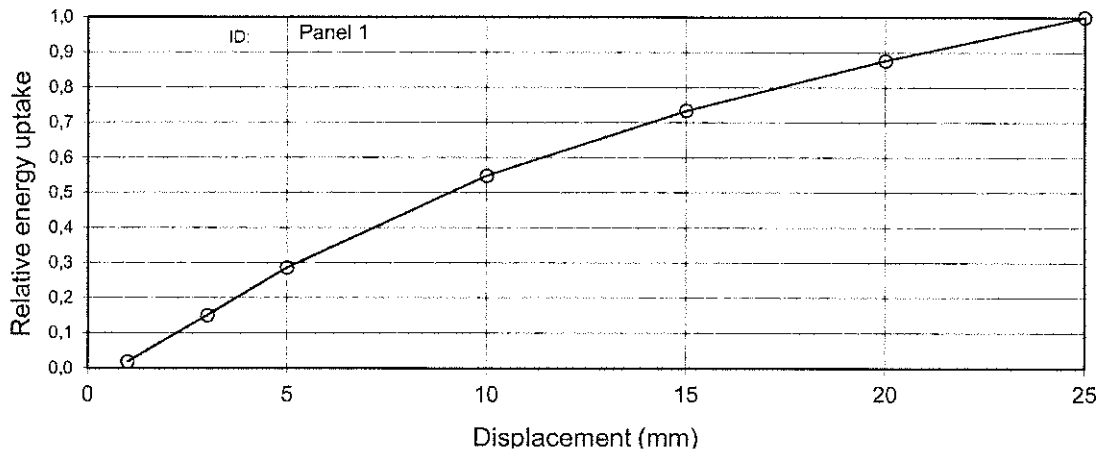
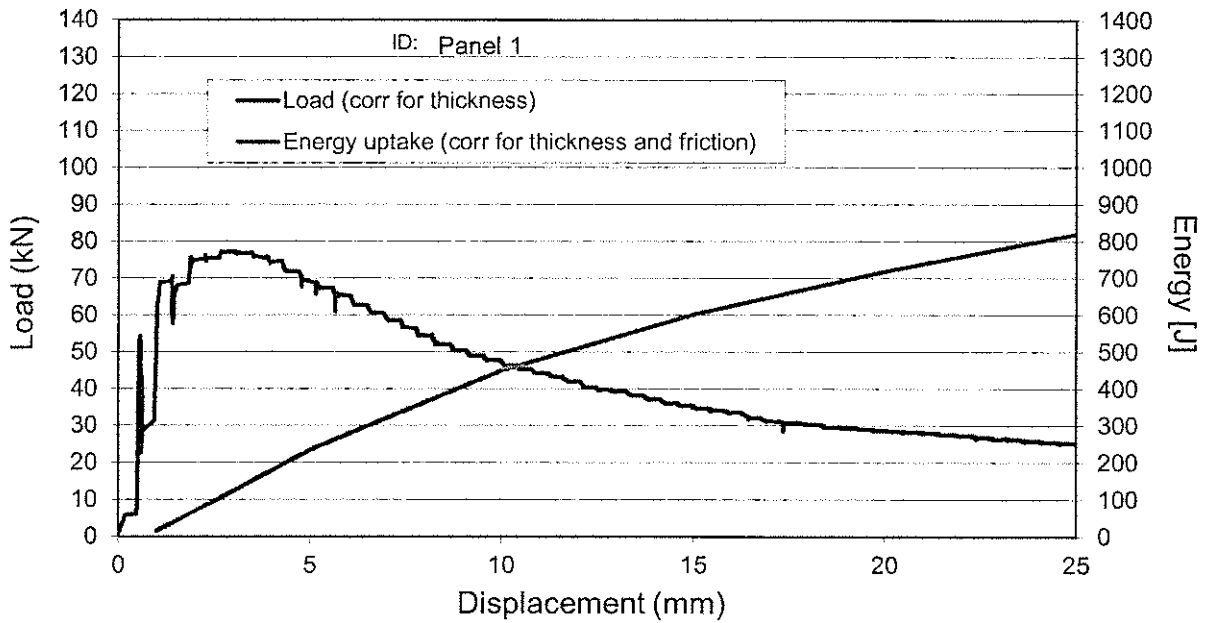

Project: Round Robin / NPRA

Panel production date: 31.03.2011

Specimen ID: Panel 5

Test date: 29.06.2011

Fibre type: Dramix

Concrete test age (d): 90

Nom. fibre dosage: 30

Comments:

Cast/sprayed: Cast

Type yes/no  
 Correct for thickness: **yes**  
 Correct for diameter: **no**  
 Correct for early non-linearity: **no**

Average plate thickness = **101,3** [mm]  
 Nominal plate thickness = 100,0 [mm]  
 Average plate diameter = **598,7** [mm]  
 Nominal plate diameter = 600,0 [mm]

Corr. factor thickness,  $k_h = 0,987$  [-]

Corr. factor diameter,  $k_D = 1,000$  [-]

Corr. factor friction,  $k_f = 0,750$  [-]

Displacement [mm]	(corrected) Energy uptake [J]	(corrected) Load [kN]	Relative Energy uptake [J]	Uncorr. Energy	Rel. uncorr/corr
1,0	14	45	0,02		
3,0	119	65	0,15		
5,0	216	63	0,28		
10,0	422	47	0,55		
15,0	570	33	0,74		
20,0	680	26	0,89		
25,0	768	21,8	1,00	1044	136,0 %

Maximum load (corr) = 74,8 [kN]  
 Displ. at max. load = 1,4 [mm]

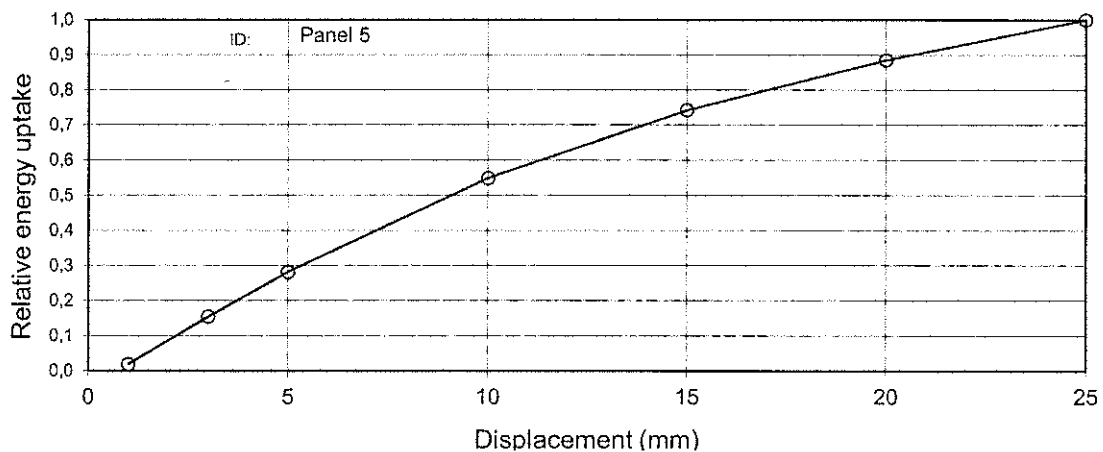
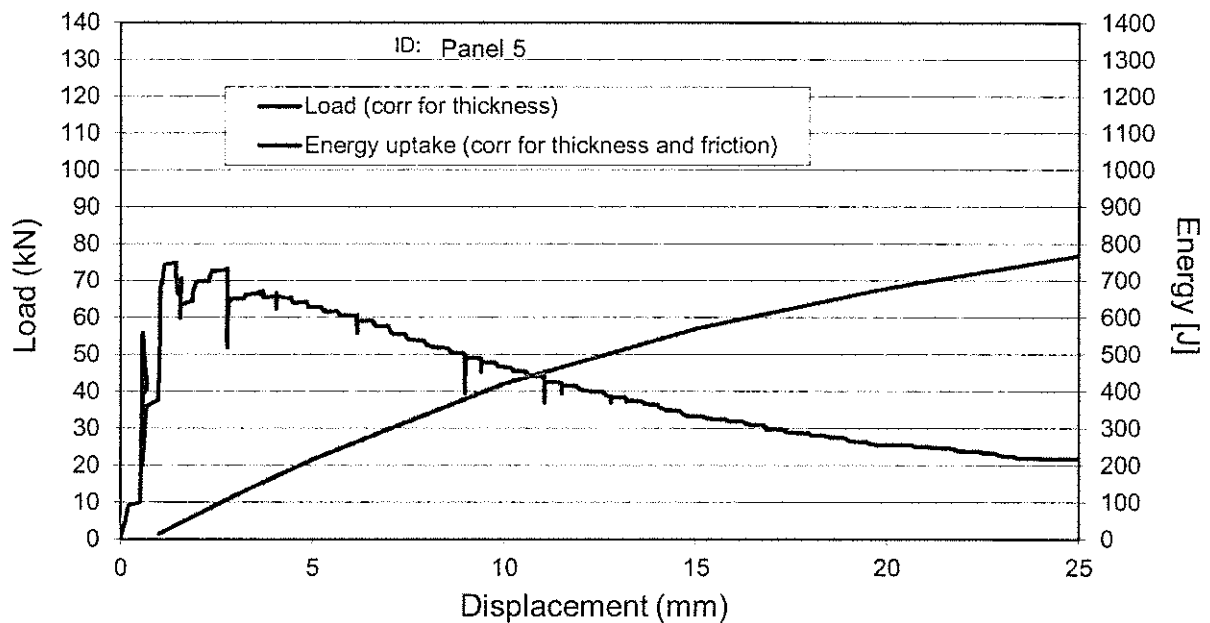



Project: Round Robin / NPRA

Panel production date: 31.03.2011

Specimen ID: Panel 12

Test date: 29.06.2011

Fibre type: Dramix

Concrete test age (d): 90

Nom. fibre dosage: 30

Comments:

Cast/sprayed: Cast

Type yes/no  
 Correct for thickness: **yes**  
 Correct for diameter: **no**  
 Correct for early non-linearity: **no**

Average plate thickness = **102,7** [mm]  
 Nominal plate thickness = 100,0 [mm]  
 Average plate diameter = **601,0** [mm]  
 Nominal plate diameter = 600,0 [mm]

Corr. factor thickness,  $k_h = 0,974$  [-]

Corr. factor diameter,  $k_D = 1,000$  [-]

Corr. factor friction,  $k_f = 0,750$  [-]

Displacement [mm]	(corrected) Energy uptake [J]	(corrected) Load [kN]	Relative Energy uptake [J]	Uncorr. Energy	Rel. uncorr/corr
1,0	19	45	0,02		
3,0	121	74	0,13		
5,0	230	69	0,25		
10,0	463	54	0,51		
15,0	646	44	0,71		
20,0	791	22	0,87		
25,0	909	26,8	1,00	1263	138,9 %

Maximum load (corr) = 83,1 [kN]

Displ. at max. load = 1,9 [mm]

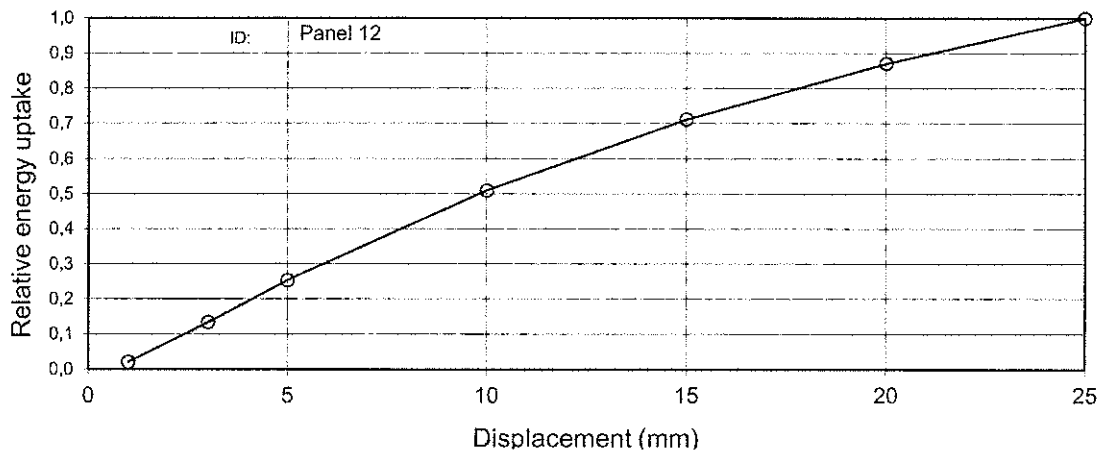
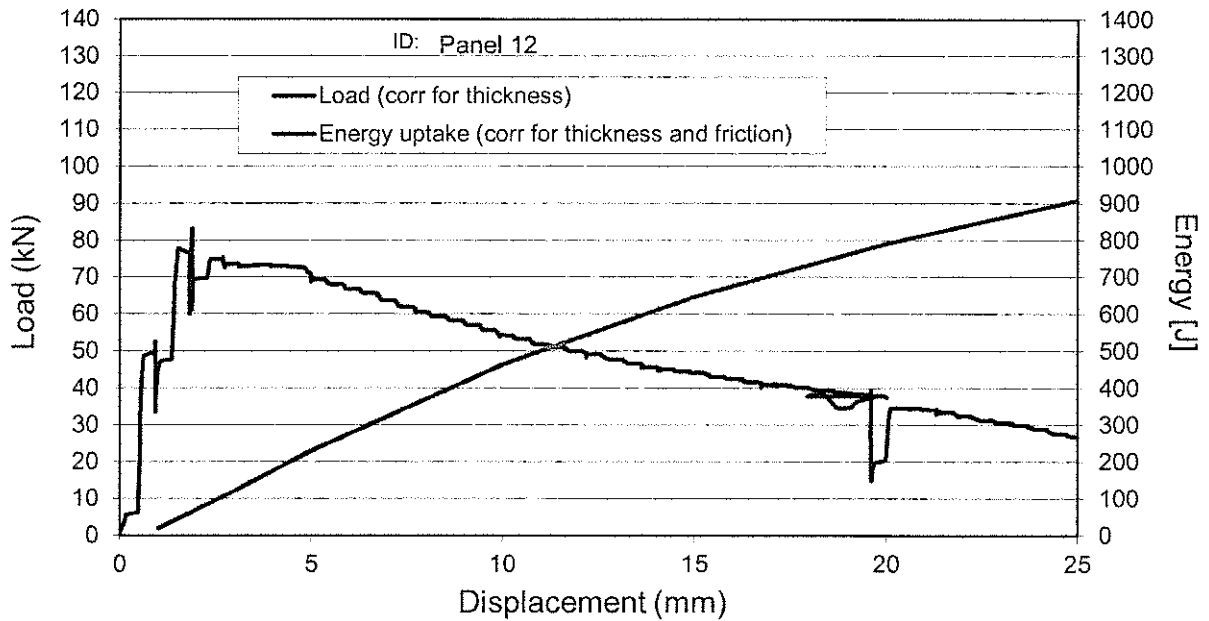

Project: Round Robin / NPRA

Panel production date: 31.03.2011

Specimen ID: Panel 13

Test date: 29.06.2011

Fibre type: Dramix

Concrete test age (d): 90

Nom. fibre dosage: 30

Comments:

Cast/sprayed: Cast

Type yes/no  
 Correct for thickness: **yes**  
 Correct for diameter: **no**  
 Correct for early non-linearity: **no**

Average plate thickness = **102,3** [mm]  
 Nominal plate thickness = 100,0 [mm]  
 Average plate diameter = **600,0** [mm]  
 Nominal plate diameter = 600,0 [mm]

Corr. factor thickness,  $k_h = 0,978$  [-]

Corr. factor diameter,  $k_D = 1,000$  [-]

Corr. factor friction,  $k_f = 0,750$  [-]

Displacement [mm]	(corrected) Energy uptake [J]	(corrected) Load [kN]	Relative Energy uptake [J]	Uncorr. Energy	Rel. uncorr/corr
1,0	15	39	0,01		
3,0	137	91	0,13		
5,0	268	84	0,26		
10,0	553	65	0,54		
15,0	763	45	0,74		
20,0	910	34	0,89		
25,0	1026	28,2	1,00	1416	138,0 %

Maximum load (corr) = 95,9 [kN]  
 Displ. at max. load = 3,6 [mm]

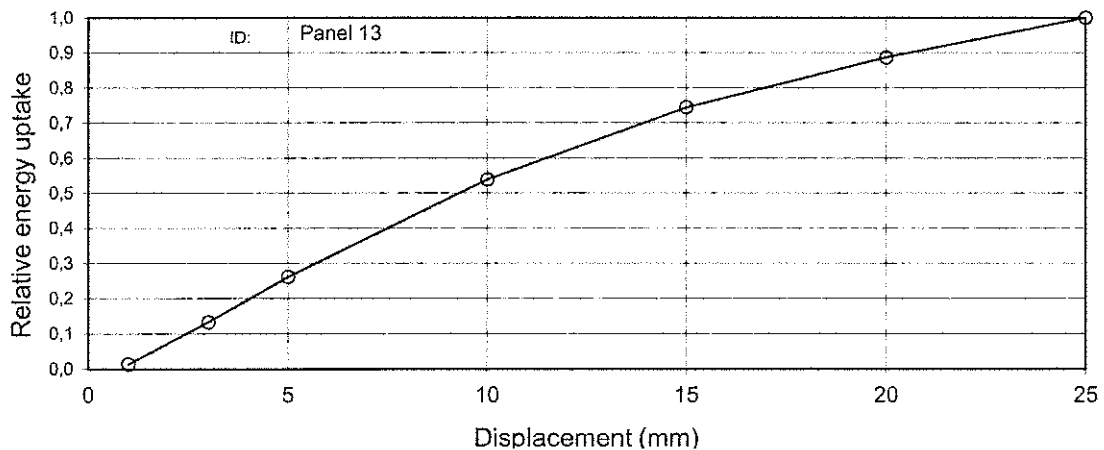
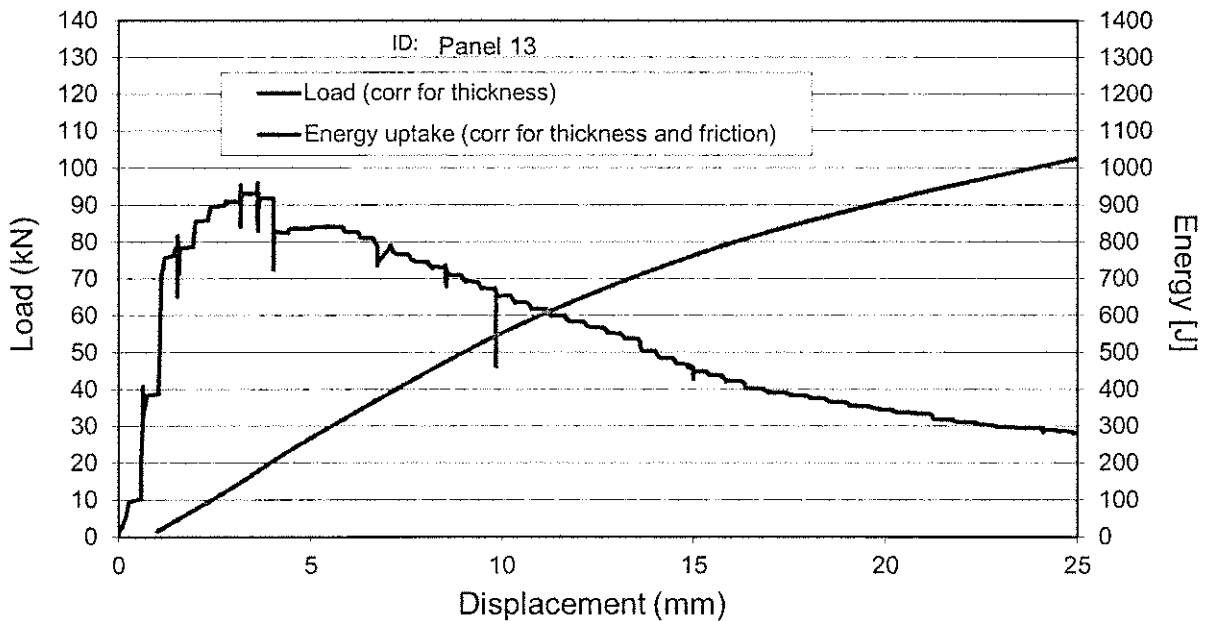

Project: Round Robin / NPRA

Panel production date: 31.03.2011

Specimen ID: Panel 19

Test date: 29.06.2011

Fibre type: Dramix

Concrete test age (d): 90

Nom. fibre dosage: 30

Comments:

Cast/sprayed: Cast

Type yes/no  
 Correct for thickness: **yes**  
 Correct for diameter: **no**  
 Correct for early non-linearity: **no**

Average plate thickness = **100,7** [mm]  
 Nominal plate thickness = 100,0 [mm]  
 Average plate diameter = **595,0** [mm]  
 Nominal plate diameter = 600,0 [mm]

Corr. factor thickness,  $k_h = 0,993$  [-]

Corr. factor diameter,  $k_D = 1,000$  [-]

Corr. factor friction,  $k_f = 0,750$  [-]

Displacement [mm]	(corrected) Energy uptake [J]	(corrected) Load [kN]	Relative Energy uptake [J]	Uncorr. Energy	Rel. uncorr/corr
1,0	14	38	0,02		
3,0	101	65	0,11		
5,0	208	71	0,23		
10,0	445	55	0,50		
15,0	625	43	0,71		
20,0	767	34	0,87		
25,0	885	29,4	1,00	1194	134,9 %

Maximum load (corr) = 73,2 [kN]  
 Displ. at max. load = 3,9 [mm]

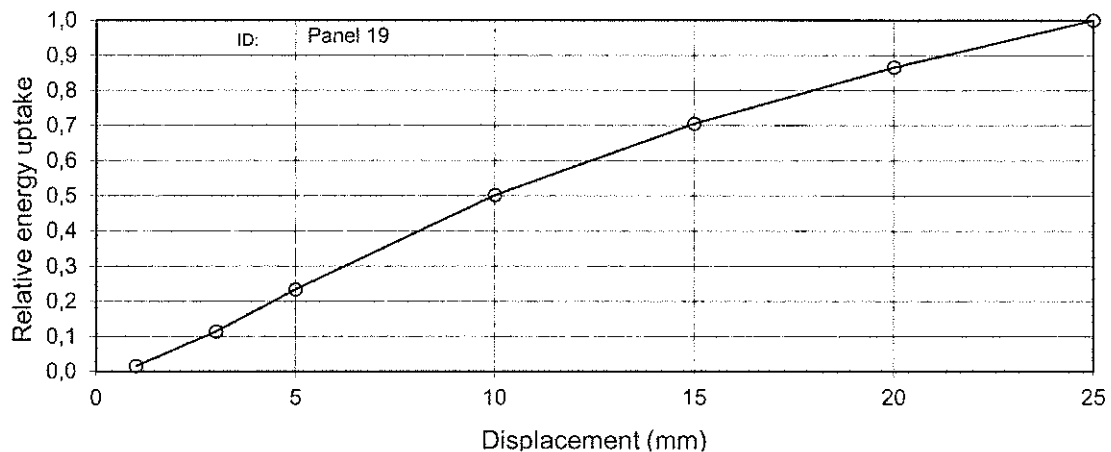
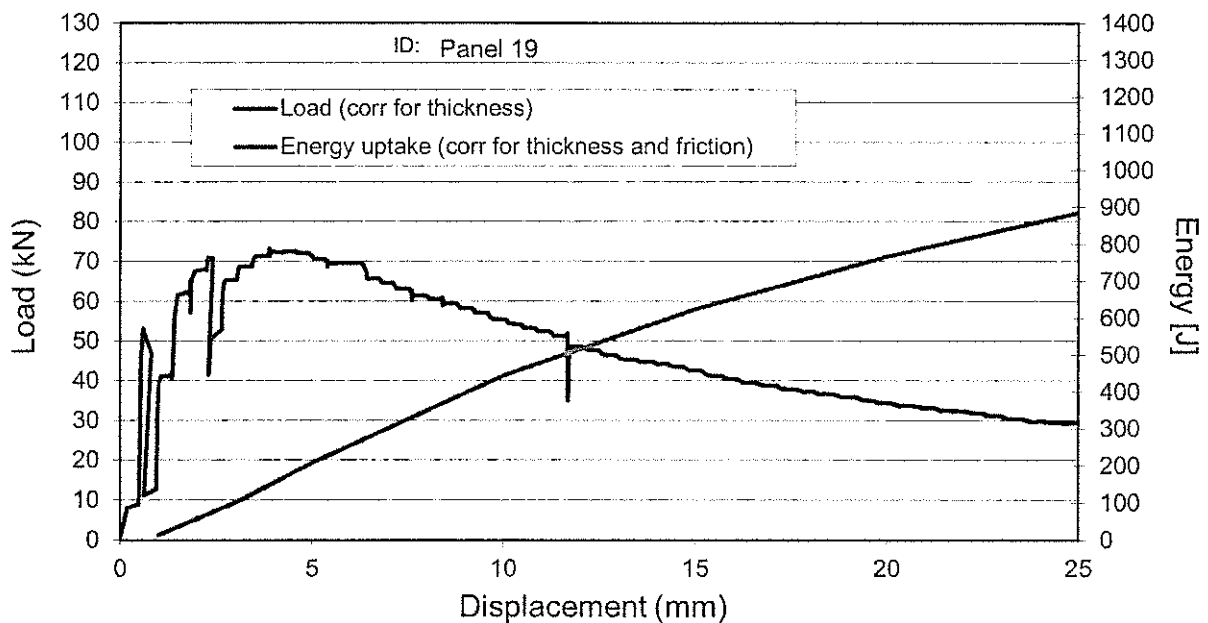

**SINTEF Building and Infrastructure** is the third largest building research institute in Europe. Our objective is to promote environmentally friendly, cost-effective products and solutions within the built environment. SINTEF Building and Infrastructure is Norway's leading provider of research-based knowledge to the construction sector. Through our activity in research and development, we have established a unique platform for disseminating knowledge throughout a large part of the construction industry.

**COIN – Concrete Innovation Center** is a Center for Research based Innovation (CRI) initiated by the Research Council of Norway. The vision of COIN is creation of more attractive concrete buildings and constructions. The primary goal is to fulfill this vision by bringing the development a major leap forward by long-term research in close alliances with the industry regarding advanced materials, efficient construction techniques and new design concepts combined with more environmentally friendly material production.

