

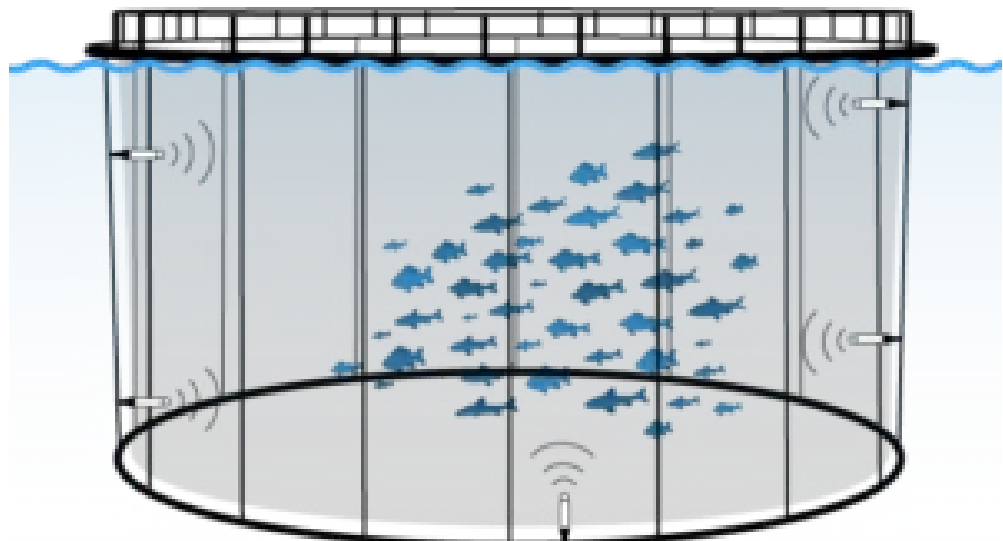
# Report

## Underwater Communication and Position Reference System

### Author(s)

Biao Su

Eleni Kelasidi, Eirik Storås Thorbjørnsen



SINTEF Ocean AS

Address:  
Postboks 4762 Torgarden  
NO-7465 Trondheim  
NORWAY

Switchboard: +47 46415000

Enterprise /VAT No:  
NO 937 357 370 MVA

# Report

## Underwater Communication and Position Reference System

REPORT NO.	PROJECT NO.	VERSION	DATE
OC2020 A-034	302002547	2	2020-03-16

**KEYWORDS:**  
[Keywords]**AUTHOR(S)**  
Biao Su  
Eleni Kelasidi, Eirik Storås Thorbjørnsen**CLIENT(S)**  
WaterLinked AS

CLIENT'S REF.	NUMBER OF PAGES/APPENDICES:
[Clients ref]	34

CLASSIFICATION	CLASSIFICATION THIS PAGE	ISBN
Open	Open	978-82-7174-378-9

**ABSTRACT**

This report presents results obtained in the CageReporter project regarding the development of a low cost hydroacoustic subsea communication system adapted for use in fish cages. The report mainly addresses tasks regarding the optimization of sender and receiver technology, as well as algorithms for advanced signal processing to optimize bandwidth while ensuring stable real-time communication during operations in fish cages. The solutions have been tested and validated in full scale field trials in two fish farms. In addition, this activity presents a solution developed to obtain a relative position reference system where the main challenge was to develop a realistic real-time map of the fish cage. The report describes the analytical study that conducted to place the acoustic transmitters. The proposed configuration has been tested in full scale. Afterwards, the obtained experimental data have been used to develop and validate numerical methods that estimate a high-resolution real-time map of the fish cage. The work furthermore includes the development of algorithms for state estimation to increase accuracy and reduce target noise. The accuracy of the position reference system has been validated through multiple filed trials.

**PREPARED BY**  
Biao Su**CHECKED BY**  
Nina Bloecher**APPROVED BY**  
Leif Magne Sunde

This document has been approved according to SINTEF's approval procedure, and is digitally secured

# Document History

---

VERSION	DATE	VERSION DESCRIPTION
1	2019-11-13	First Draft of the document

---

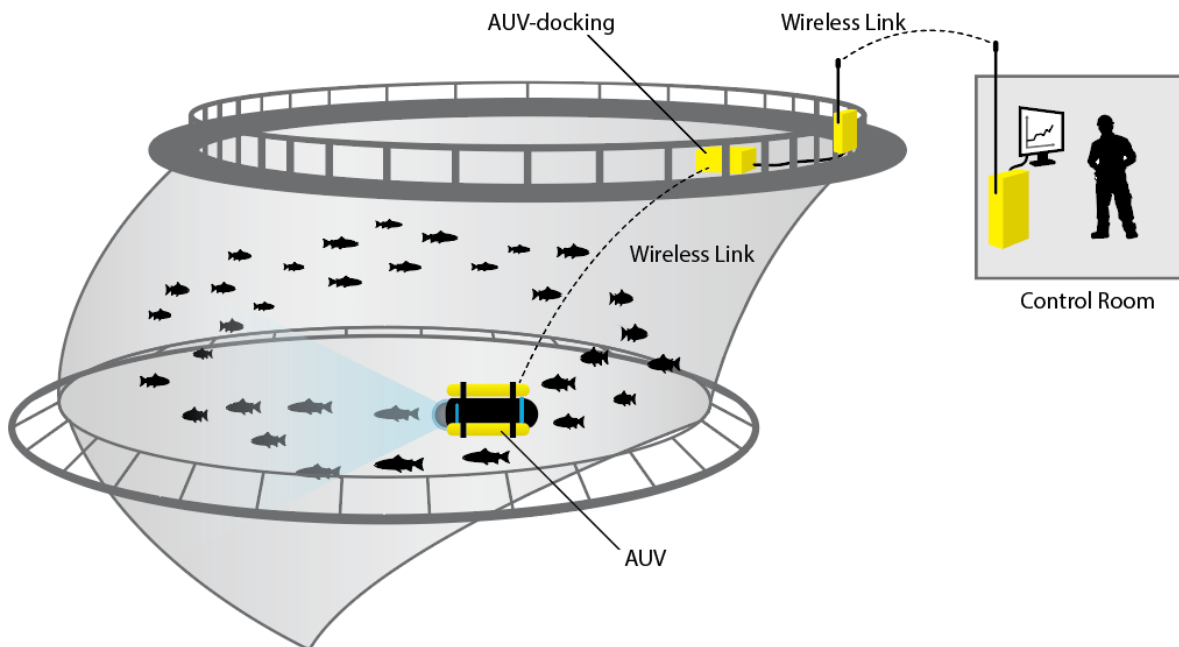
2	16.03.2020	Final version of the report
---	------------	-----------------------------

# Table of Contents

<b>1</b>	<b>Background</b> .....	<b>4</b>
<b>2</b>	<b>Underwater communication</b> .....	<b>5</b>
2.1	Developed technology .....	5
2.2	Modem M64 validation tests .....	9
<b>3</b>	<b>Position reference system</b> .....	<b>11</b>
3.1	Lab and field deployment .....	11
3.2	Numerical estimation model .....	20
<b>4</b>	<b>Conclusion</b> .....	<b>27</b>
<b>5</b>	<b>References</b> .....	<b>27</b>
<b>A</b>	<b>Appendix: Installation in Hosnaøyen</b> .....	<b>28</b>
<b>B</b>	<b>Appendix: Installation in Rataren</b> .....	<b>31</b>

## 1 Background

The CageReporter project adapts the use of autonomous and tetherless underwater vehicles as a carrier of sensor systems for data acquisition, where the data are transferred from sea-based fish cages to a centralized land base (Figure 1). The vehicle will use active motion control and acquire data from the cage environment while exploring the fish cages. The main project objective is to develop technology for autonomous functionality for adaptive mission planning to achieve high quality data acquisition from the cage space. One of the most important capabilities within this context is to operate in a dynamically changing environment in interaction with the biomass (bio-interactive) and the aquaculture structures. The project addresses many challenges within the aquaculture industry related to poor accuracy and representative sampling of important variables from the whole volume of the cage. A successful project outcome will lead to new technology for collection of high-resolution data that could be utilized for assessment of the fish farm state, grouped within three main areas: A) fish, B) aquaculture structures and C) production environment. Examples of areas of applications are detection of abnormal fish behaviour, net inspection and mapping of water quality. CageReporter will provide a solution for continuous 24/7 inspection of the current situation and will be the mobile eyes of the fish farmer in the cage environment. The project idea is based on using low-cost technology for underwater communication, vehicle positioning, and camera systems for 3D vision.



**Figure 1 Resident (24/7), autonomous, non-tethered vehicle (AUV) for high quality data acquisition**

A robust high-bandwidth and low cost communication system is a key element of the project, and the realization of such a solution requires significant research efforts. Hydroacoustic communication is highly demanding in the presence of biomass in the signal path, as the acoustic signals are subjected to scattering and damping. Note that the density of biomass changes considerably in the course of the production cycle, where the fish grows from an average weight of approx. 100g to 5kg. Consequently, an important requirement is that the system will be able to handle this variability in biomass during the operations in fish cages. This brings significant R&D challenges related to further developing underwater communication system to achieve stable real-time communication with good coverage throughout the entire cage.

The research need is also related to the development of a cage-relative position reference system that reports the position of an underwater vehicle relative to the fish cage. Such a system is required for accurate positioning and motion control of an underwater vehicle inside the fish cages. The positioning of the vehicle in fish cages is an extra demanding task compared to conventional operations with fixed structures, since the fish net is deformed by waves and currents (Rundtop and Frank, 2016). In the following, this report describes

the development and validation of the underwater communication technology and the position reference system. In this study, the underwater positioning system developed by WaterLinkes AS (i.e. wLink) has been used in combination with numerical methods to realize a position reference system, and the research need lies in developing a wLink configuration that provides good performance in combination with the numerical methods. In particular, in order to realize a cage-relative position reference system, wLink has been used in the Short Base Line (SBL) configuration with four acoustic receivers attached to the cage and an acoustic transmitter placed on the vehicle to measure the position of the vehicle relative to the cage. In addition, three acoustic transmitters have been placed in different locations in the fish cage, where the measured positions have been used in combination with a numerical model of the fish cage, to estimate an updated real-time map of the deformable fish cage.

## 2 Underwater communication

Based on the wLink technology, a low cost hydroacoustic subsea communication system was developed and adapted for use in the cage. The development and adaptation included the optimization of sender and receiver technology, as well as development of algorithms for advanced signal processing to optimize bandwidth while ensuring stable real-time communication under conditions that affect the communication link. The developed solution was tested and validated at full scale farm sites.

### 2.1 Developed technology

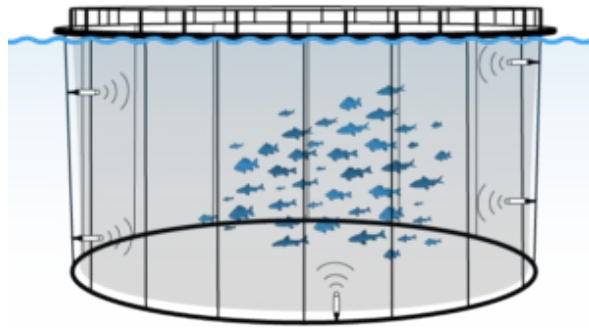
In the project CageReporter, Water Linked has continued the development of the underwater communication technology wLINK. This development has resulted in the acoustic modem named 'Water Linked Modem M64', Figure 2.



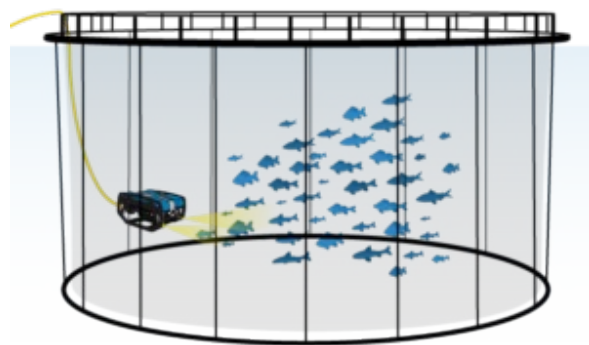
**Figure 2 Modem M64**

The Modem M64 uses WaterLinked's own transducer and electronics. It has a transmission rate of 64 bits per second and a range of 200 meters. The modem is omnidirectional, meaning that the modem transmits and receives in all directions. What makes the M64 modem unique is its small physical size and the highly robust datalink provides to the user. These capabilities are what makes the Modem M64 suitable for use in fish cages and other high reflective and noisy environments like in harbors.

In many operations it is not practical to use cabled sensors since the cable itself can amount to significant cost. In addition, the installation can be cumbersome and time consuming which further adds cost. Cables are also by their nature prone to damage which may cut off the sensor entirely and trigger extensive costs for replacement. To avoid all this, the WaterLinked modem M64 can be utilized to remove the need for the cable entirely (Figure 3). By connecting the M64 with the sensor and a battery pack, one receives a fully wireless sensor with a very robust setup. The sensor can be read by another Modem M64 which can reside in a fixed place topside. The M64 modems can also be mounted on ROVs, ships or other moving vehicles for dynamic interrogation of the sensors (Figure 4). By utilizing the WaterLinked Underwater GPS system, all locations (i.e. position of a net, vehicle, feeding camera, etc.) can easily be documented real-time during daily operations in fish cages.



**Figure 3 Illustration of wireless sensors installed on a fish cage**

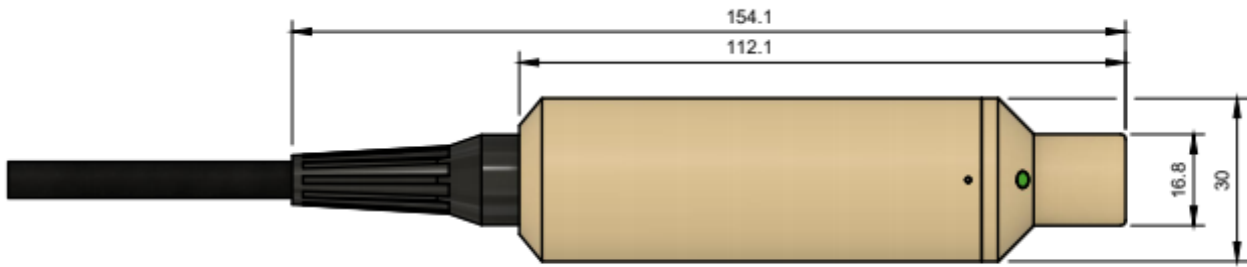


**Figure 4 Illustration of wireless sensor installed on the ROV**

The algorithms and protocols that WaterLinked uses are designed to handle the demanding environments of a sea cage. WaterLinked's own signal processing has been optimized considerably to filter out noise and other error sources which can lead to drop out of communication. These adjustments are both in hardware of the modem and software. Legacy modems typically use the carrier frequency to decide if the value sent is "0" or "1". This is very vulnerable to interference and packet loss and makes them unsuited for use in fish cages and other reflective environments. In contrast, the Modem M64 uses modern error correction techniques which are more robust. In addition, the Modem M64 not only has an advanced auto-sync feature which makes it extremely easy to use, it is also, other than classic modems, fully omnidirectional. The omnidirectional property is especially important for underwater vehicle applications where the modems are in constant motion and can be turned around all axes while still maintaining its robust data link. With WaterLinked's Modem M64, real time communication in fish cages is possible. The specification of the developed Modem M64 are given in Table 1 and Figure 5.

**Table 1 Specifications of Modem M64**

Communication	Two-way communication, 64 bit per second net data link, both ways
Typical latency	~500ms
Directivity	Omnidirectional
Acoustic range	200 m
Depth rating	300 m
Device length	112 mm
Device diameter	30 mm
Device weight	128 g
Input voltage	10-18 V

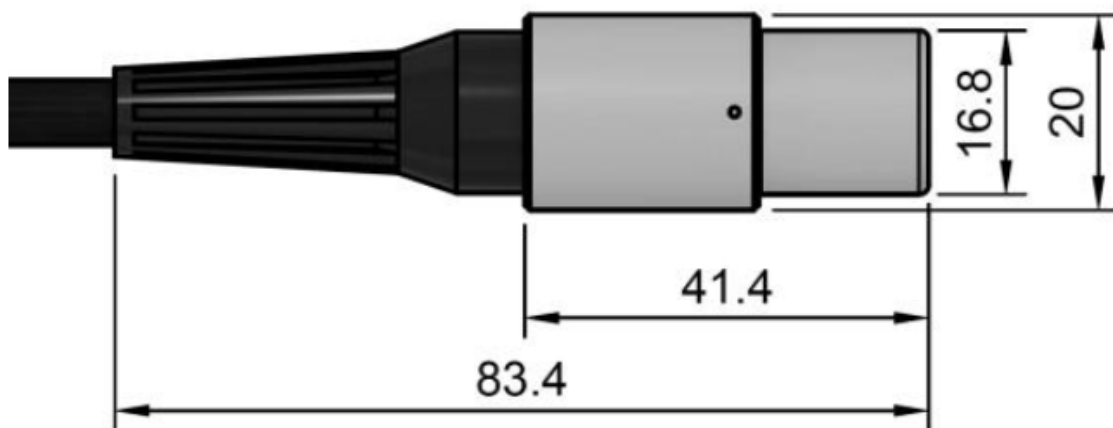


**Figure 5 Dimensions of Modem M64 (dimentions are given in mm)**

Waterlinked has developed several locators and receivers. In this project, the WL-21009 Locator-A1, WL-21018 Locator-U1 and WL-21005 Receiver-D1 were used in order to obtain results for the underwater positioning regerence systems. The specifications and dimentions are given in Tables 2-4 and Figures 6-8.

**Table 2 Specifications of WL-21009 Locator-A1**

Directivity	Omnidirectional
<b>Depth sensor</b>	<b>None</b>
Depth rating	300 m
Default cable length	1 m
Max cable length	300 m (custom order)
Signaling	1x twisted pairs
Cable type	PUR 6.3 mm
Cable connector	None
Device length	41 mm
Device diameter	20 mm
Device weight in air	30 g
Operating temperature	-10 to 60 °C



**Figure 6 Dimensions WL-21009 Locator-A1 (dimentions are given in mm)**



**Table 3 Specifications of WL-21018 Locator-U1**

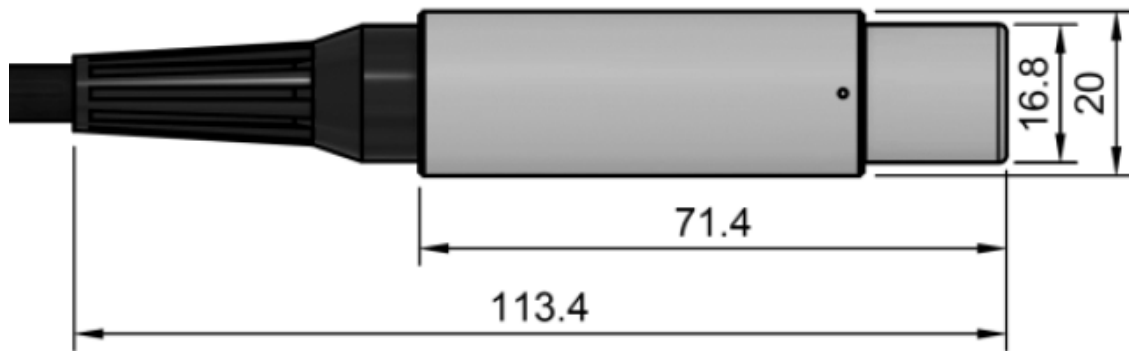
Directivity	Omnidirectional
<b>Depth sensor</b>	<b>Integrated</b>
Depth rating	300 m
Max operational range	100 m (wireless)
Battery size	3.7 volt, 3300 mAh
Battery lifetime	10 hours
Device length	121 mm
Device diameter	32 mm
Device weight (air)	175 g
Operating temperature	-10 to 60 °C



**Figure 7 Dimensions WL-21018 Locator-U1 (dimentions are given in mm)**

**Table 4 Specifications of WL-21005 Receiver-D1**

Directivity	Omnidirectional
Depth rating	300 m
Max cable length	100 m
Signaling	2x twisted pairs
Cable type	PUR 6.3 mm
Cable connector	Binder Series-770 (IP67)
Device length	71 mm
Device diameter	20 mm
Device weight	36 g
Input voltage	10-18 V
Input current	35 mA
Operating temperature	-10 to 60 °C



**Figure 8 Dimensions WL-21005 Receiver-D1 (dimentions are given in mm)**

**2.2 Modem M64 validation tests**

WaterLinked has performed multiple tests of the acoustic Modem M64. Initially tests were performed at WaterLinkeds office in a test tank to verify and optimize the hardware, software and algorithms. The test tank is made of plastic and creates a test environment with lots of reflections and noise. Up to 50 reflections of the initial signal have been observed before it disappears. This creates a very good test environment for developing the modem and algorithms used to remove noise and reflections.

After these initial tests, the modem has been tested in Brattøra (Figure 9-11) and Monkholmen (Figure 12) in Trondheim. These areas both provide a reflective environment. The tests have been performed to verify that the communication link works well over longer distances and also when moving in water. Testing distance varied from a couple of meters up to 200 meters. These tests, together with the results from the test tank, confirmed that the modem M64 provides a robust and very stable communication link in reflective and noisy environment (Figure 13).



**Figure 9 Test in Brattøra – highly reflective environment**



Figure 10 Online monitoring system in Brattøra tests

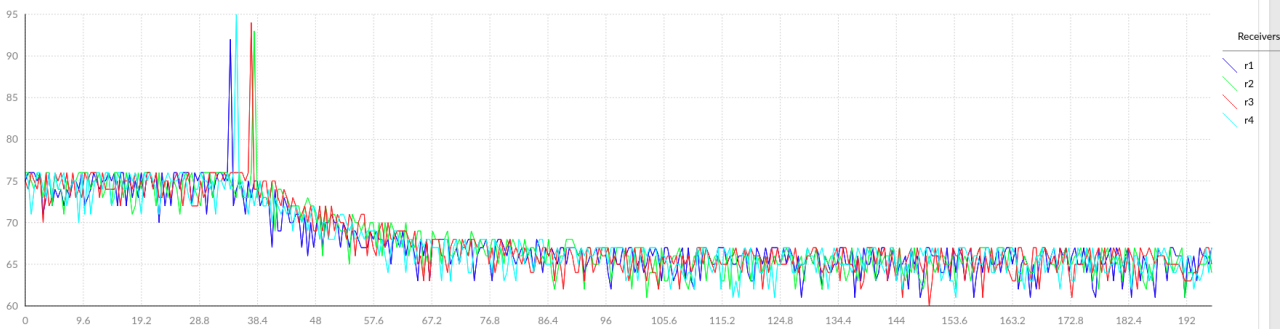


Figure 11 Obtained trajectory and accuracy of the underwater positioning system in Brattøra tests





**Figure 12 Munkholm test with one modem M64 on dock and the other on the boat**



**Figure 13 Data from four receivers showing acoustic signals over time**

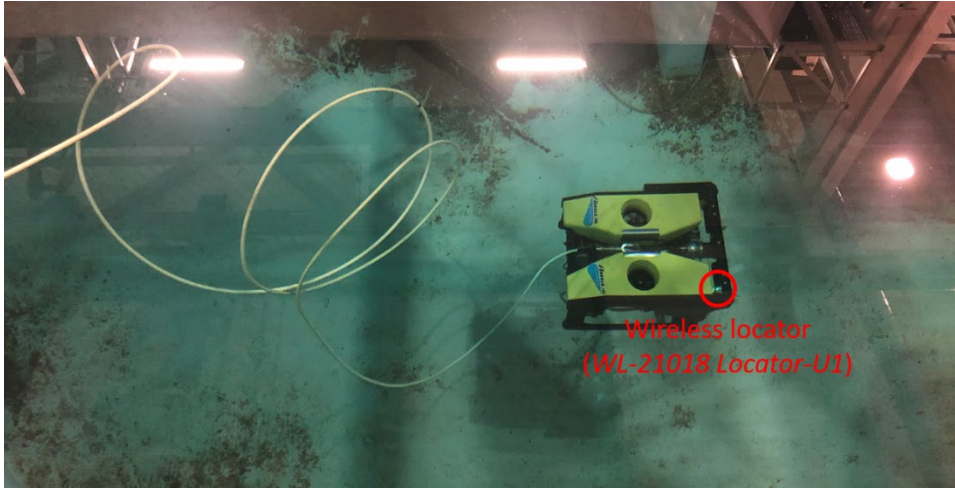
### 3 Position reference system

This activity presents the development of a relative position reference system where the main challenge was to develop a realistic real-time map of the fish cage. The analytical study was conducted in order to decide on the placement of the acoustic transmitters. The proposed configuration has been tested in full scale. The obtained experimental data have been used to develop and validate numerical methods that estimate a high-resolution real-time map of the fish cage. The work further included the development of algorithms for state estimation to increase accuracy and reduce target noise. Well established methods of processing and state estimation were used (Fossen, 2011). The position reference system was validated through multiple trial series where positioning accuracy was evaluated.

#### 3.1 Lab and field deployment

The WaterLinked positioning system consists of a topside positioning computer and a certain number of locators and receivers: the locators are sending acoustic signals which are picked up by the receivers and the topside positioning computer uses advanced algorithms to triangulate and calculate the positions of the

locators based on the signals received by the receivers. This system has been tested at the Hosnanøya and Rataren sites (SINTEF ACE full-scale laboratory facility) in 2018 and 2019, and at the Ocean Basin Laboratory (SINTEF Ocean) in 2019 (Figure 14). Based on the results of the model-scale testing at the lab and the initial full-scale tests at Hosnøyan and Rataren, the WL-21009 Locator-A1, WL-21018 Locator-U1 and WL-21005 Receiver-D1 were chosen for the final deployment at the Rataren site-Cage 7 (Figure 15) in 2019.



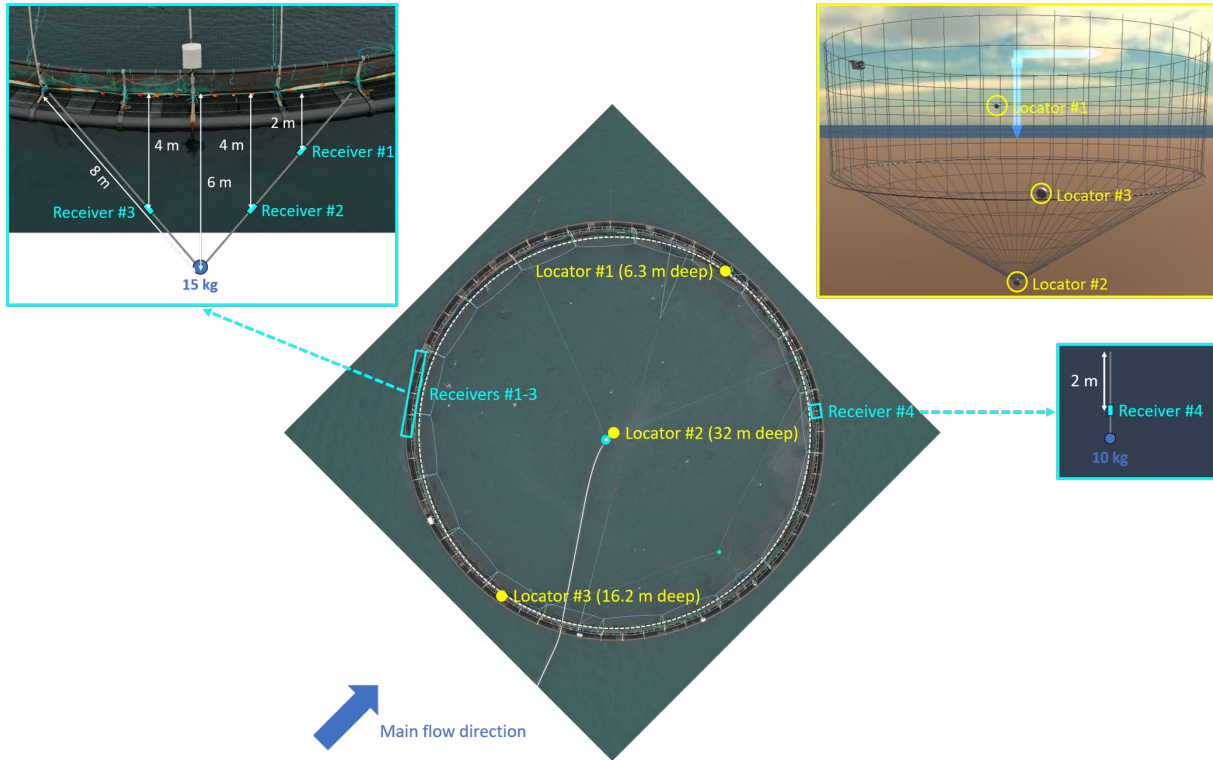
**Figure 14 ROV testing at the Ocean Basin Laboratory (SINTEF Ocean)**



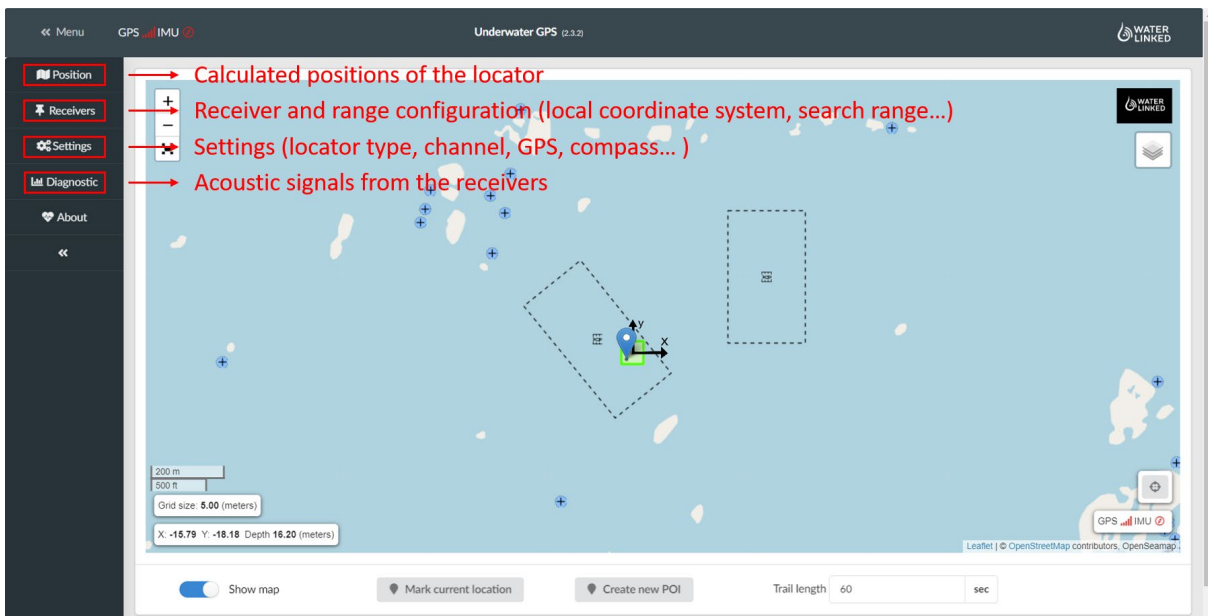
**Figure 15 SINTEF ACE Rataren site**

As shown in Figure 16, three locators (*WL-21009 Locator-A1*) were installed in a cage (Cage 7) at the Rataren site: the first one was attached to the lower edge of the sea-lice skirt (in 6.3 m depth), the second one was attached to the bottom tip of the net (in 32 m depth), the third one was attached to the connection rope between the net and the sinker tube (in 16.2 m depth). Four receivers (*WL-21005 Receiver-D1*) were used to pick up the acoustic signals from each locator. Receivers #1-3 were placed along a rope connecting two points along the walkway (xm distance) and hanging down to 6m depth in the middle where a weight was attached (Figure 16): two of the receivers were placed at 4 m depth on both sides of the weight, and the third one was placed at 2 m depth. Receiver #4 was placed at 2 m depth on the opposite side of the cage (Figure 16). All locators and receivers were connected by cables to the topside cabinet, from where the obtained signals were send out through the integrated 4G modem. More detailed information regarding the installation process can be found in Appendices A-B.

WaterLinked also provides an online monitoring system (Figure 17) for data collection and setting up parameters for the positioning system, e.g. locator type, search range and the local coordinate system for calculating relative positions of the locators. Acoustic signals from the receivers and calculated positions of the locators can be displayed and recorded instantaneously through the designated web address.



**Figure 16** Field deployment at the Rataren site

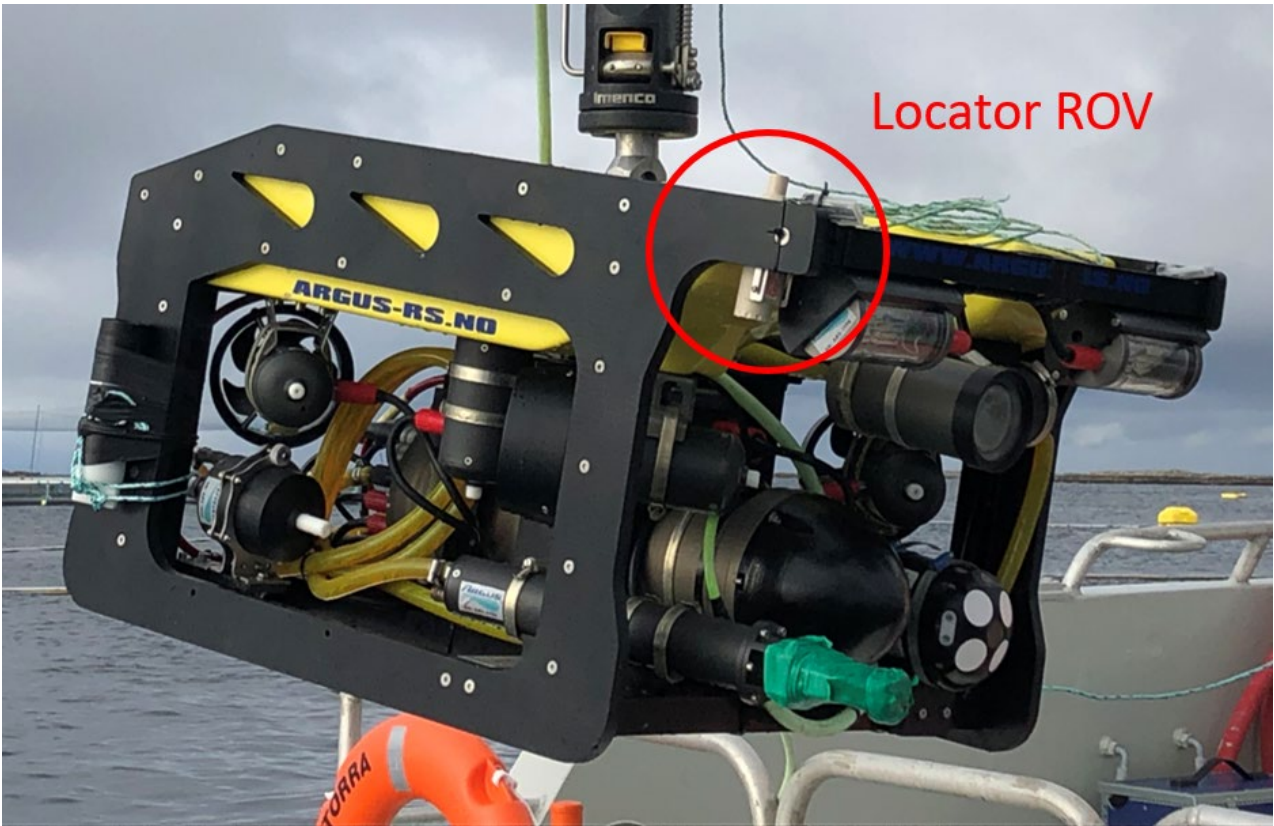


**Figure 17** WaterLinked online monitoring system

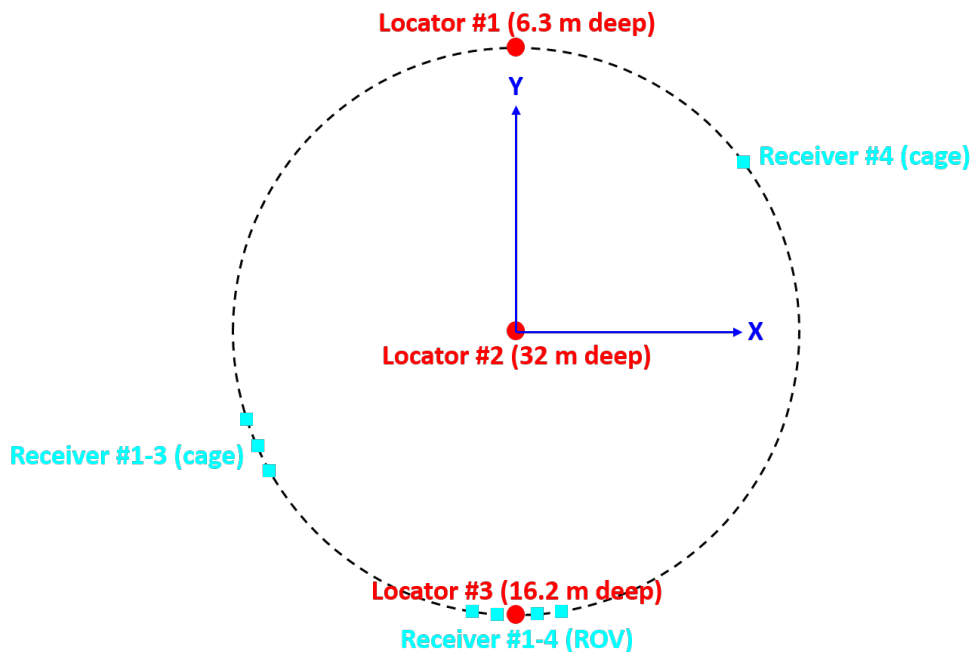
For positioning the ROV in the field trial, a wireless locator (*WL-21018 Locator-U1*) attached to the ROV and four separated receivers (*WL-21005 Receiver-D1*) were used (Figure 18). The configuration of the receivers was adjusted in order to calculate ROV positions in the same local coordinate system as that used for the net



(Figure 19). Instead of using 4G, a PC was directly connected to the topside cabinet through a local network for importing real-time positioning data to a numerical estimation model.



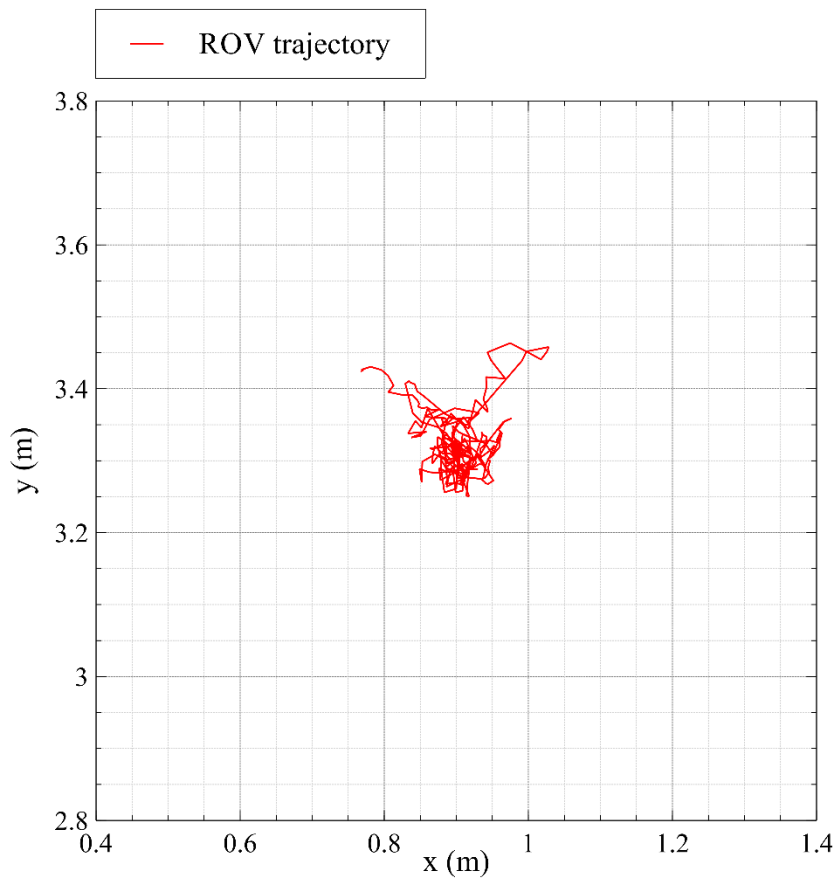
**Figure 18** WL-21018 Locator-U1 used to obtain real-time position of the ROV in fish cage



**Figure 19** Configuration of the local coordinate system in the field trial

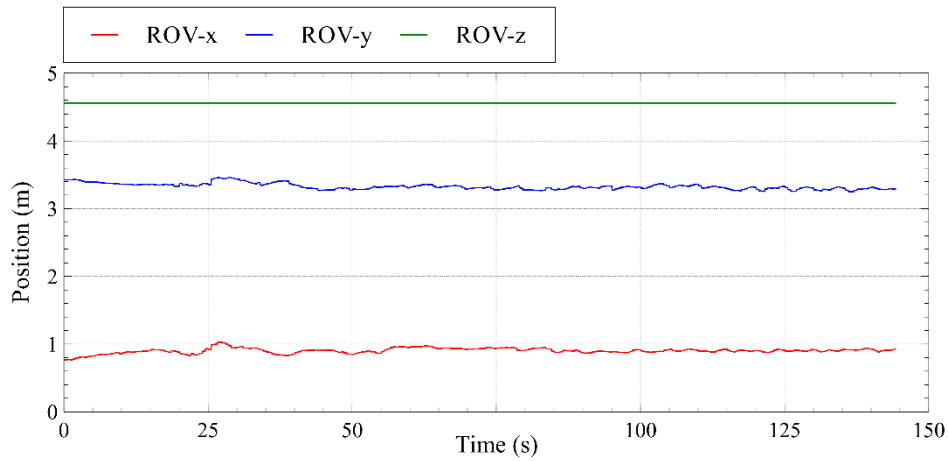
Figure 20 shows an example of the recorded trajectory of a ROV (Remotely Operated Vehicle) at the Ocean Basin Laboratory, where the ROV was lying on the bottom of the tank and a wireless locator was used for positioning. The corresponding time series of the measured positions is shown to be reasonably stable (Figure

21). As it was not possible to have the ROV lying on the bottom of the cage during the field trial in order to assess the precision of the measurements, the ROV was controlled to keep the desired position by using a nonlinear Dynamic position (DP) controller. Figure 22 - 27 show that the measured positions were stable and no significant errors occurred (i.e. jumping signals or loss of signals) on the measured positions. The precision of the measurements during both the lab tests and field trials show that the accuracy of the positioning system is suited to obtain accurate position measurements of static (i.e. tests in the tank where the ROV is sitting on the bottom of the tank) and moving objects (i.e. tests in the cage where the ROV is keeping the desired position in the cage using DP controller) underwater and for the implementation of autonomous control functions for the navigation of the underwater vehicle. In addition, it should be mentioned that with better tuning of the control gains of the DP controller we were able to obtain even better accuracy for the position of the system during dynamic positioning of the vehicle, thus enabling the ROV to navigate in the cage without inputs from the ROV operator or the site manager of the fish farm.

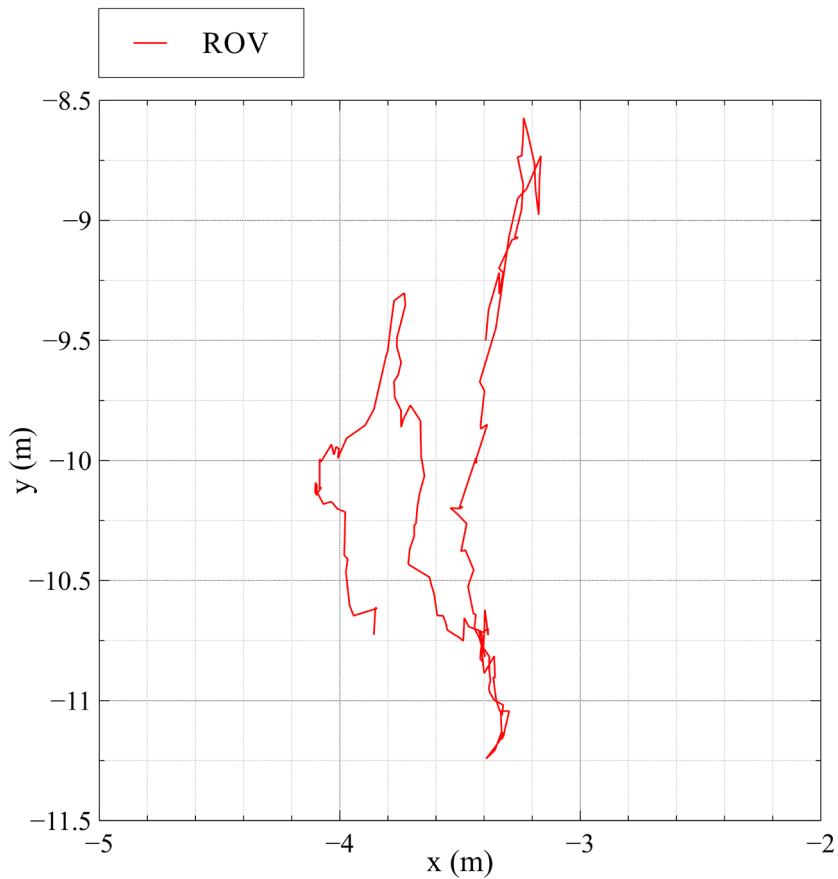


**Figure 20 Recorded trajectory of the ROV sitting at the bottom of the Ocean Basin Laboratory**

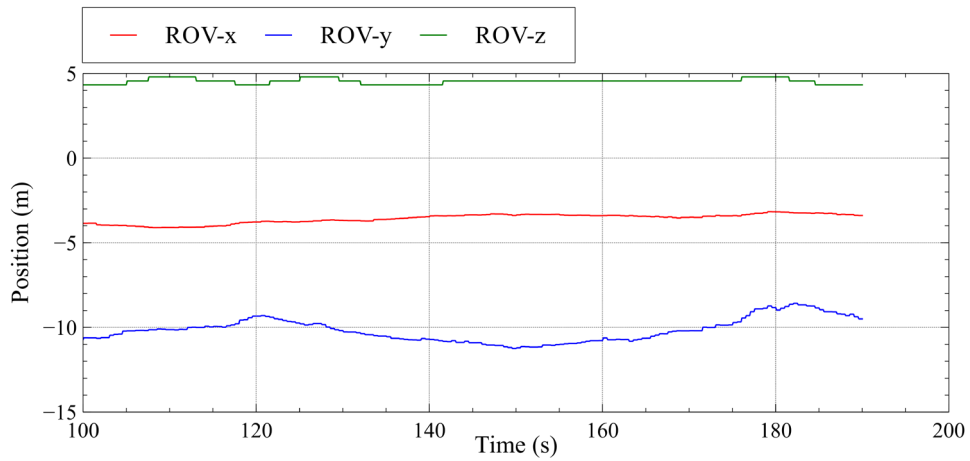




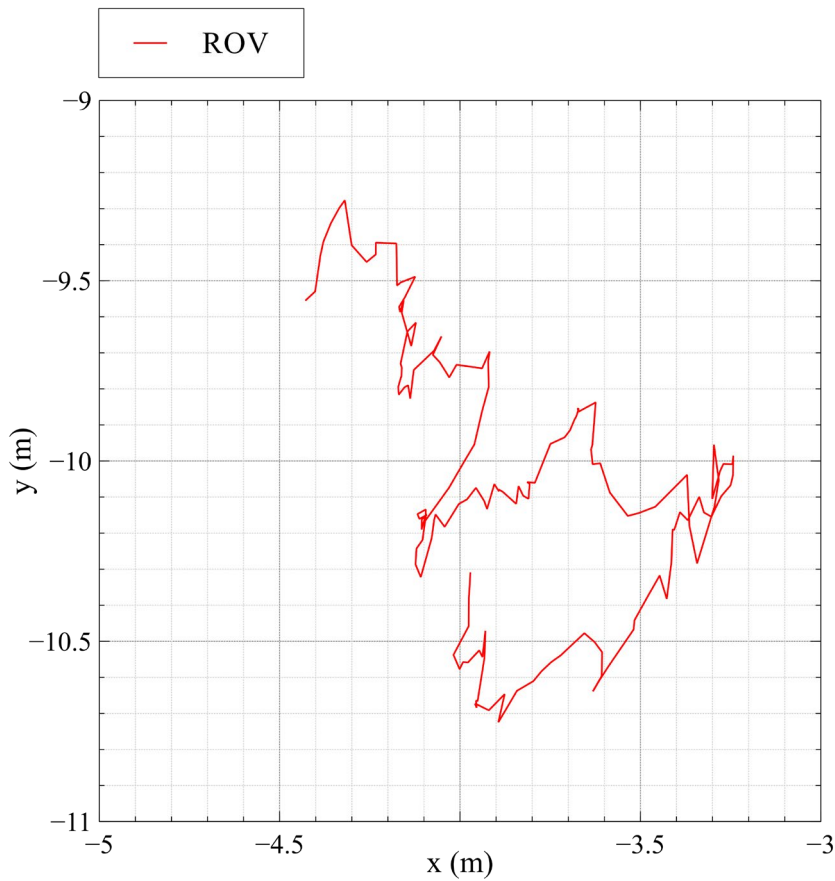
**Figure 21 Time series of the measured ROV positions (corresponding to Figure 20)**



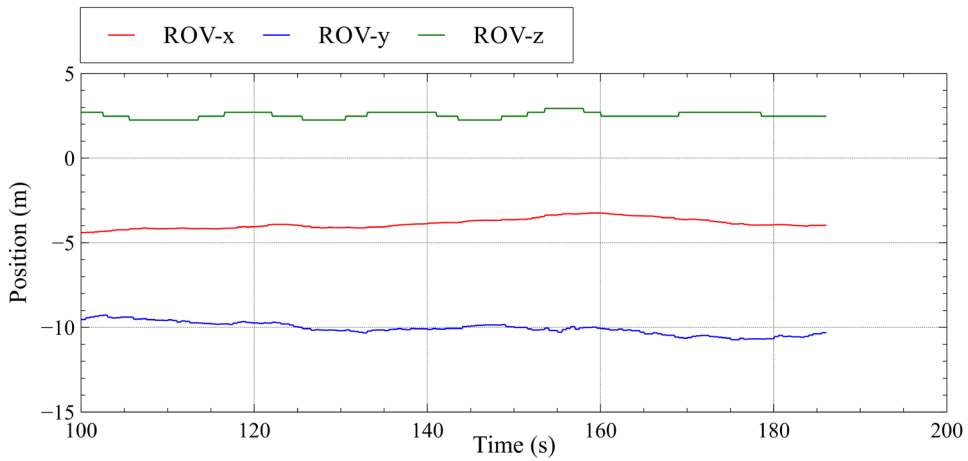
**Figure 22 Recorded trajectory of the ROV in the field trial for desired position X=-3.3m, Y=-9.9m and Z=4.5m**



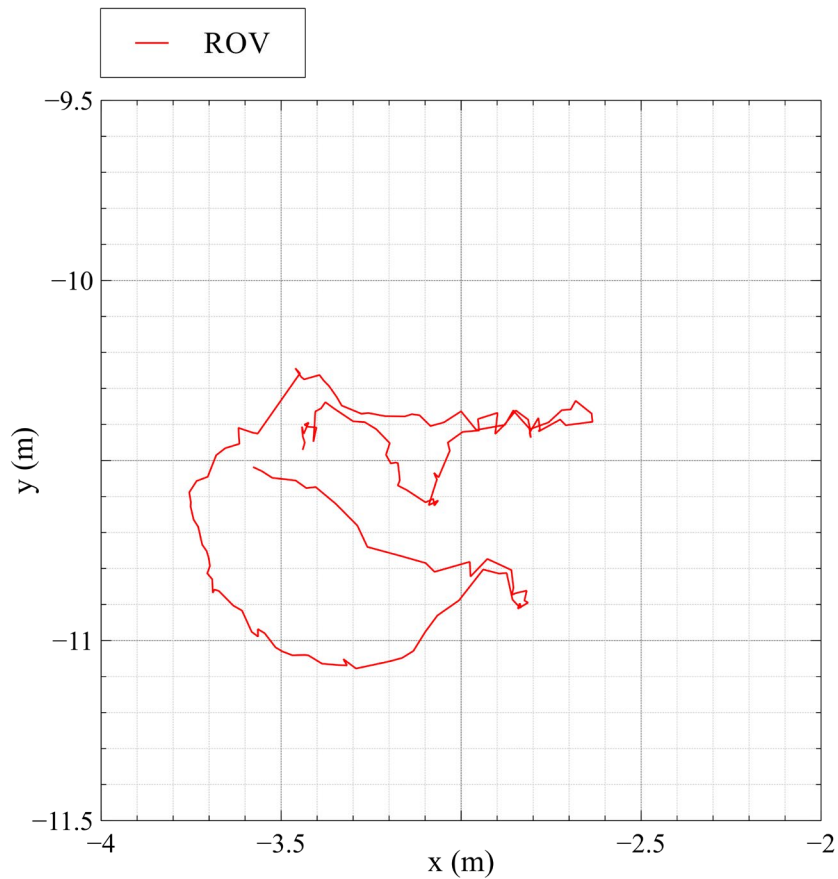
**Figure 23 Time series of the measured ROV positions in the field trial (corresponding to Figure 22)**



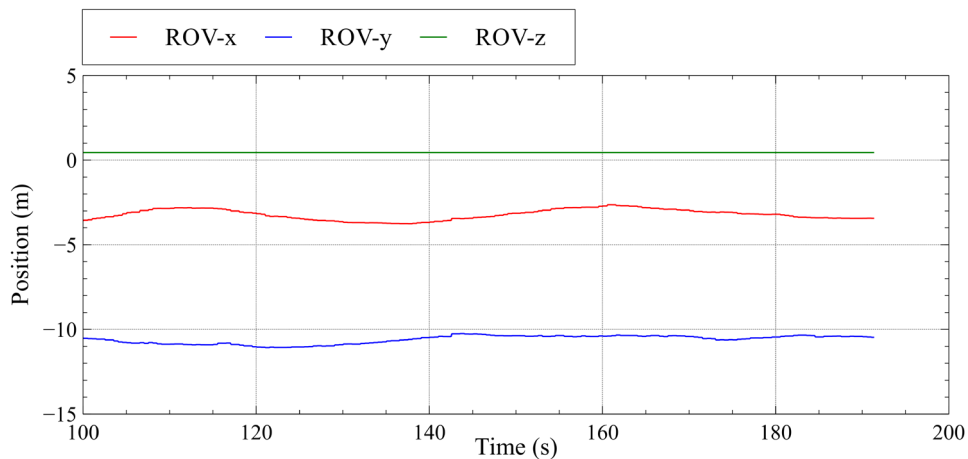
**Figure 24 Recorded trajectory of the ROV in the field trial for desired position X=-3.3m, Y=-9.9m and Z=2.5m**



**Figure 25 Time series of the measured ROV positions in the field trial (corresponding to Figure 24)**

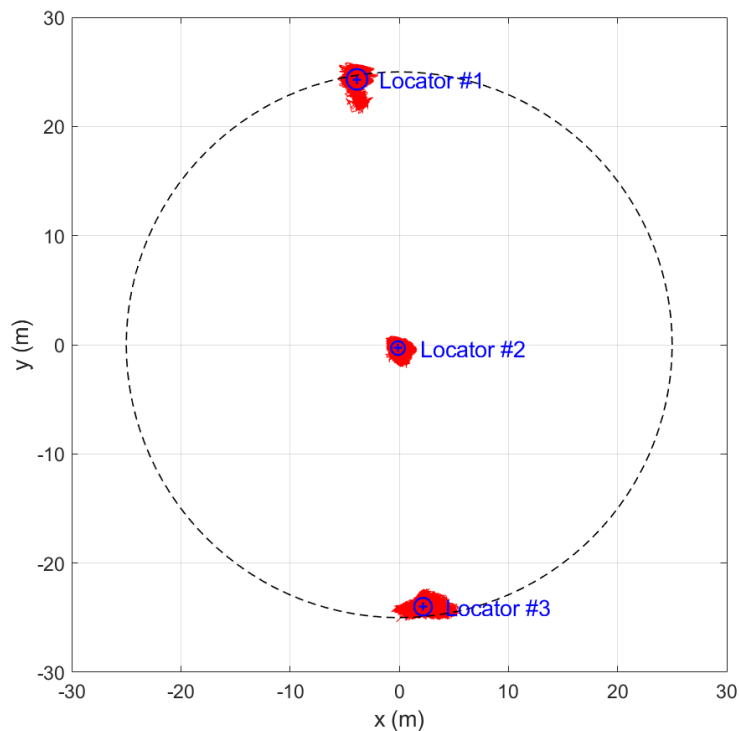


**Figure 26 Recorded trajectory of the ROV in the field trial for desired position X=-3.3m, Y=-9.9m and Z=0.5m**

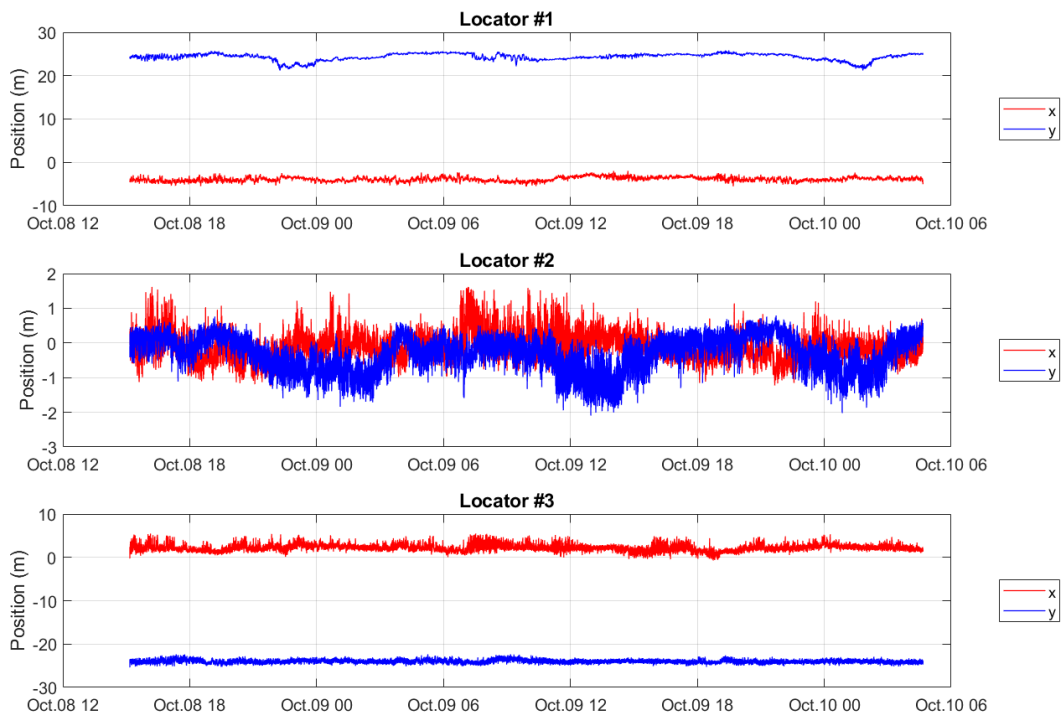


**Figure 27 Time series of the measured ROV positions in the field trial (corresponding to Figure 26)**

Figure 28 shows an example of the measured positions from the three locators on the net cage over a period of 37.5 hours (3 tidal periods). It is evident that the measured positions deviate from the idealized configuration (Figure 19), because the actual net cage did not have an exactly cylindrically-conical shape at all times. The trajectory of Locator #1 shows the displacement of the net elements at 6.3 m depth to be in accordance with the main direction of tidal flow, while the displacement of the net at 16.2 m depth (Locator #3) is shown to be in another direction. This indicates a possible change of flow direction with water depth due to local variations (e.g. geomorphology or fluid-structure interactions). The corresponding time series of the measured positions (e.g. Figure 29) show that the positioning system had a noise level of about 2 m, which is suited for the estimation of cage deformations on an average level (i.e. neglecting short-period deviations).



**Figure 28 Recorded trajectories (red) of the three locators on the net. The blue crosses denote the calculated mean positions and the blue circles denote the corresponding standard deviations**



**Figure 29 Time series of the measured locator positions (corresponding to Figure 28)**

### 3.2 Numerical estimation model

FhSim is a software framework that has been under continuous development at SINTEF Ocean since 2006 (Reite et. al. 2014; Su et. al. 2019). It provides numerical models for time-domain simulation of flexible net cages in current and waves. FhSim also contains a module for system state estimation based on a nonlinear extended Kalman filter (Einicke and White, 1999). By using this method, a numerical model can be combined with sensor data to create a more realistic estimation of the actual system. However, it is found to be difficult for real-time implementation considering a net-cage system with a large number of states. For this reason, a simplified net-cage model with an adaptive current field was used to estimate net-cage deformations based on the measured positions of the net (Figure 30). Error signals, i.e. the deviation of the estimated positions compared to the measured positions, are used to adapt the magnitude and direction of the current at various depths. The adaptation is using a PID controller with integral saturation for each error signal.

This method was first tested with simulated data, i.e. two simulated positions of the net under given current and wave conditions. In the estimation model, the magnitude and direction of the current were unknown and they were continuously adapted. At the same time, the adapted current forces were also applied in the estimation of net-cage deformations, until a best fit to the simulated data was achieved. Figure 31 and Figure 32 show an example of the position errors (i.e. estimation errors which are defined as differences between the measured and estimated positions) and the estimated current velocities, which demonstrates the potential of using two measured positions (in the horizontal plane) for the estimation of net-cage deformations by adapting the current profiles (i.e. current velocities and directions at various depths).

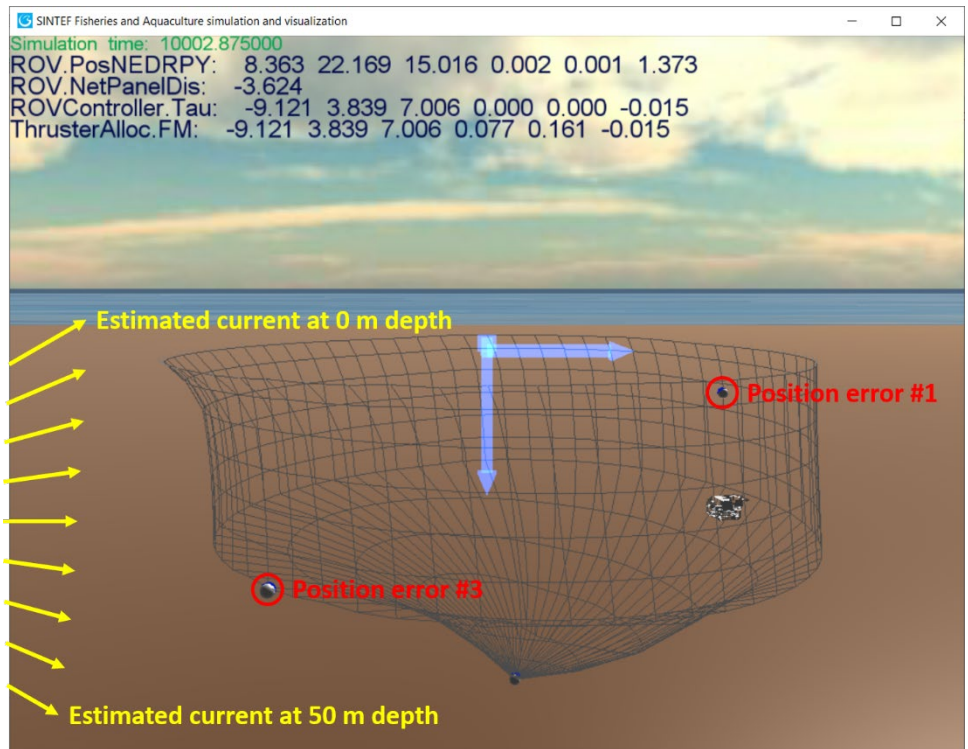


Figure 30 A simplified net-cage model with an adaptive current field based on two measured positions of the net

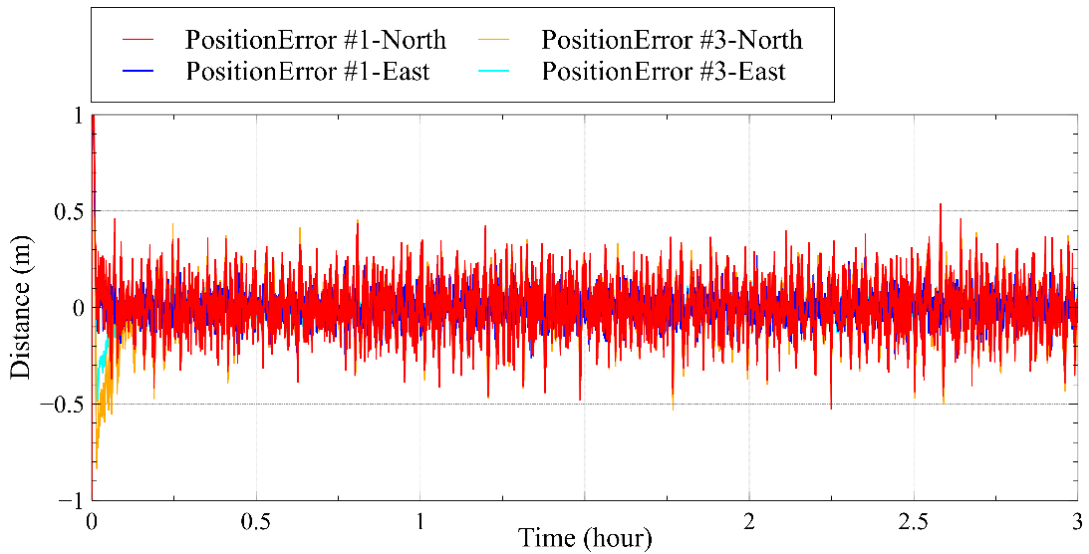
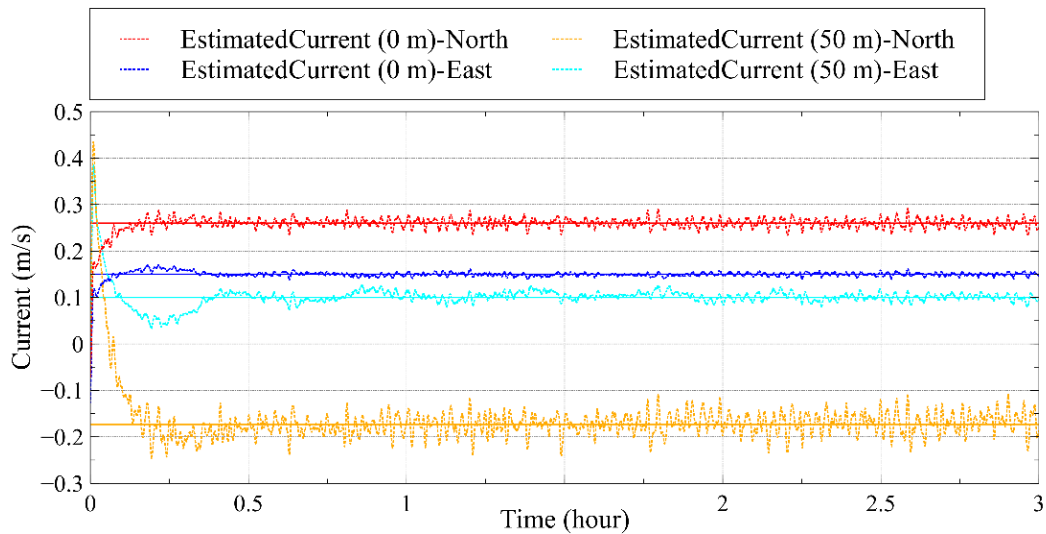


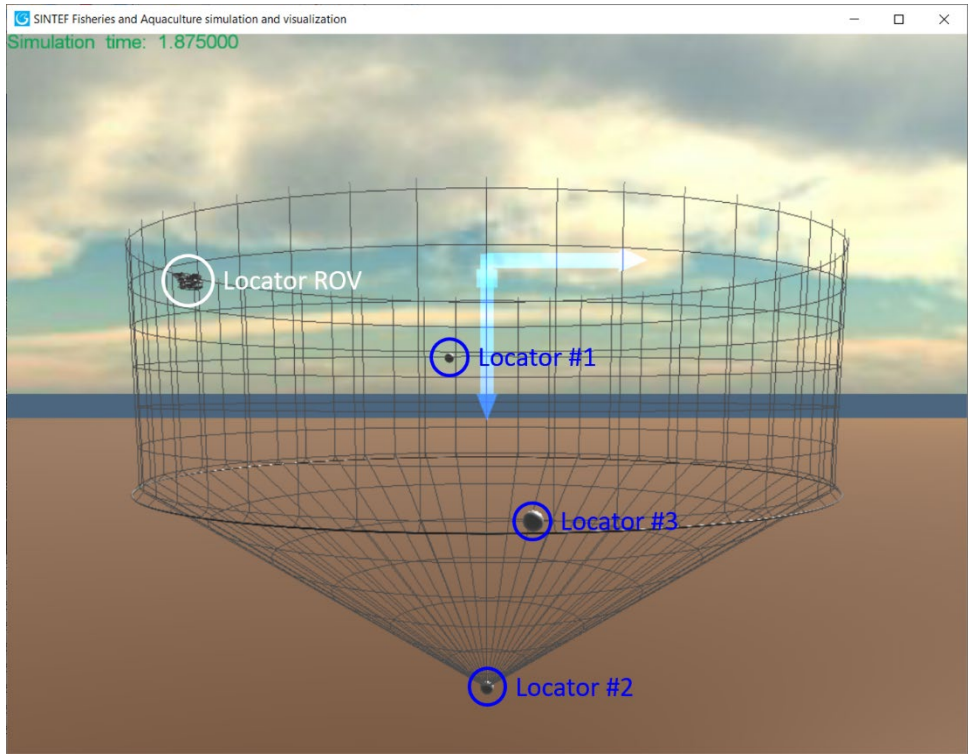
Figure 31 Errors of the estimated positions relative to the "measured" positions



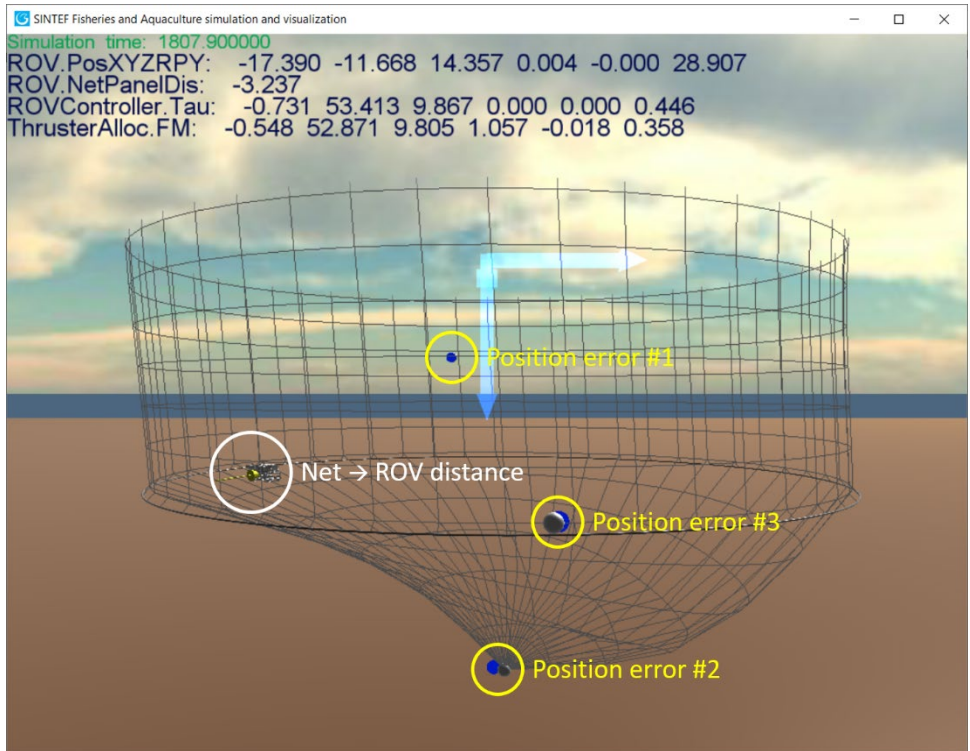
**Figure 32 Estimated current velocities (dotted lines) and the comparison with the "actual" current velocities (solid lines)**

The mean positions of the three locators measured during three tidal periods in the field trial (see e.g. in Figure 28) and were used to determine a representative configuration of the positioning system in the simplified numerical estimation model (Figure 33), where each locator is related to a fixed point on the net cage. Figure 34 shows an example of the estimated net deformation based on the two measured positions (Locator #1 and Locator #3) from the field trial. The time series of measured positions and the corresponding errors of estimations are shown in Figure 35 and Figure 36, respectively. It should be noted that only two locators were used in the estimation model, while the third one (Locator #2) was used for verification. As shown in the example, for all three locators, the maximum estimation error was below 3 m (Figure 36), which was in the same range as the deviation of the measured data in a period of 1 hour (Figure 35). Figure 3.37 shows another example of the positions measured on another day where the deviations of one locator (x-position of Locator #3) were significantly higher, while the estimation results (Figure 3.38) were found to be still as good as the previous one (Figure 36). The estimation model has been verified by 11 data sets (each lasted one hour) from the field trials, and it proved to be suitable for real-time applications.



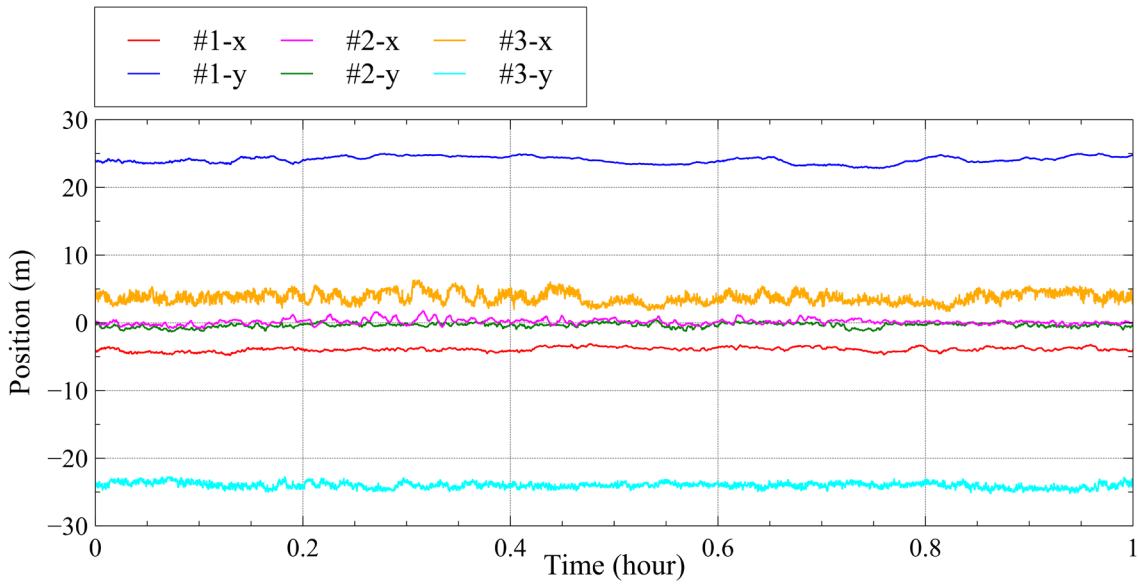


**Figure 33 Configuration of the positioning system in the numerical estimation model**

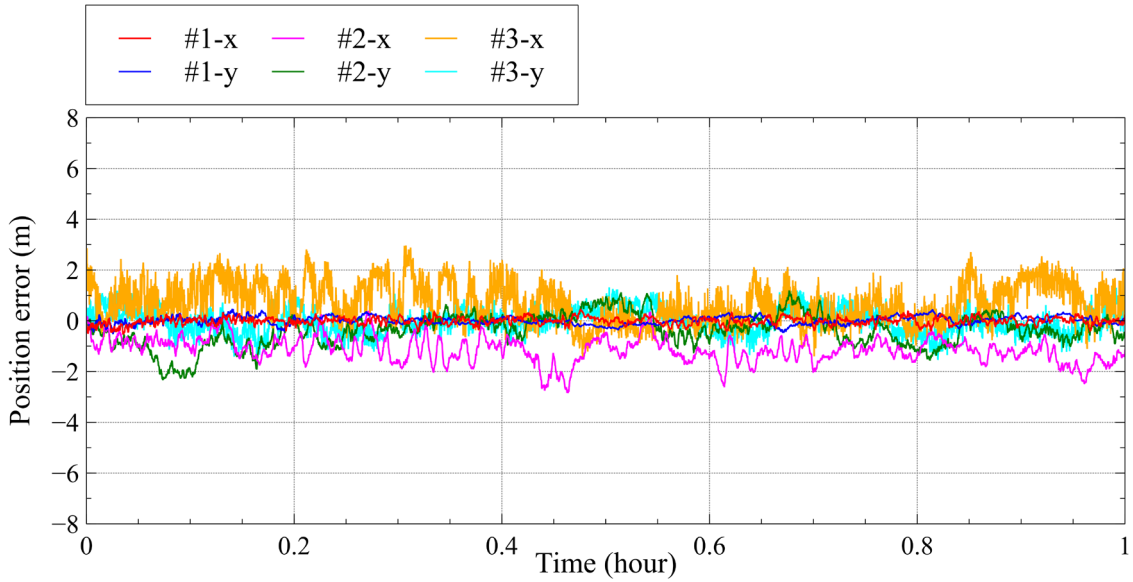


**Figure 34 An example of the estimated net deformation where the blue points denote the measurement data and the grey points denote the estimated positions of the net cage**

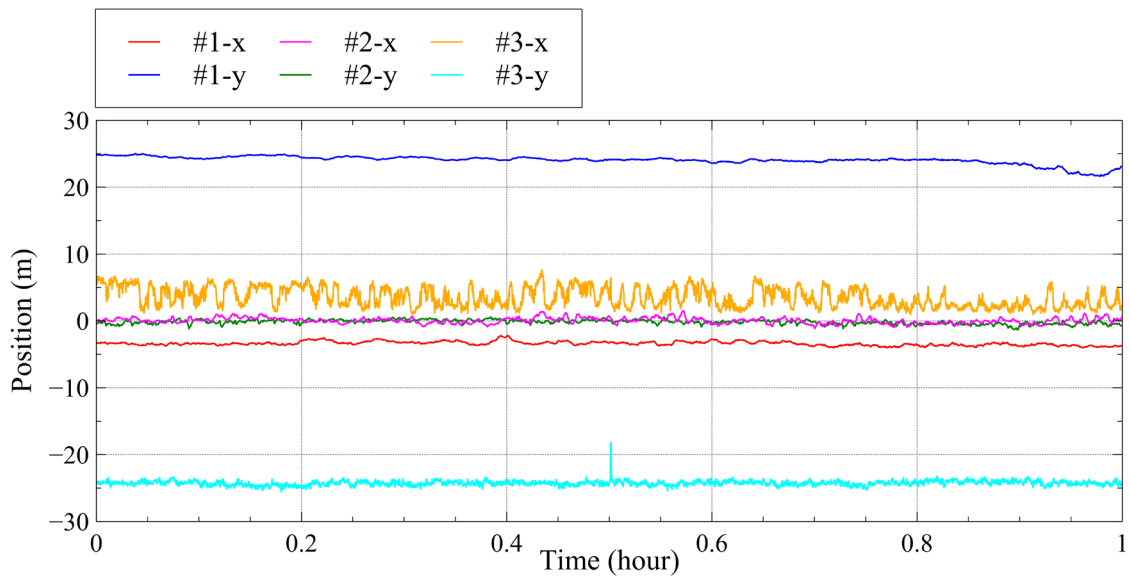




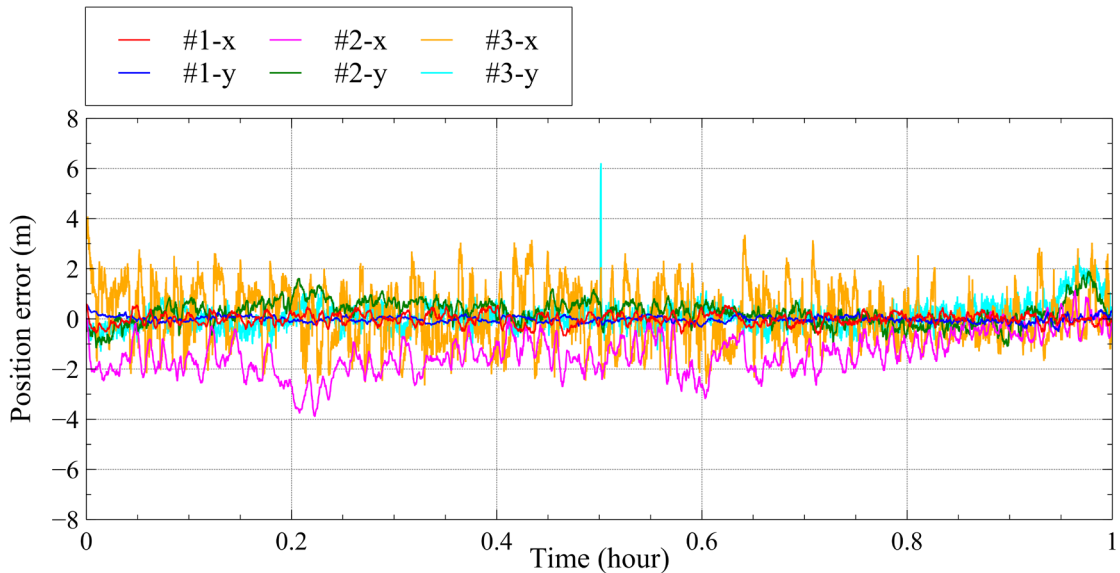
**Figure 35** An example of the time series of measured positions



**Figure 36** Errors of the estimated positions relative to the measured positions (corresponding to Figure 35)

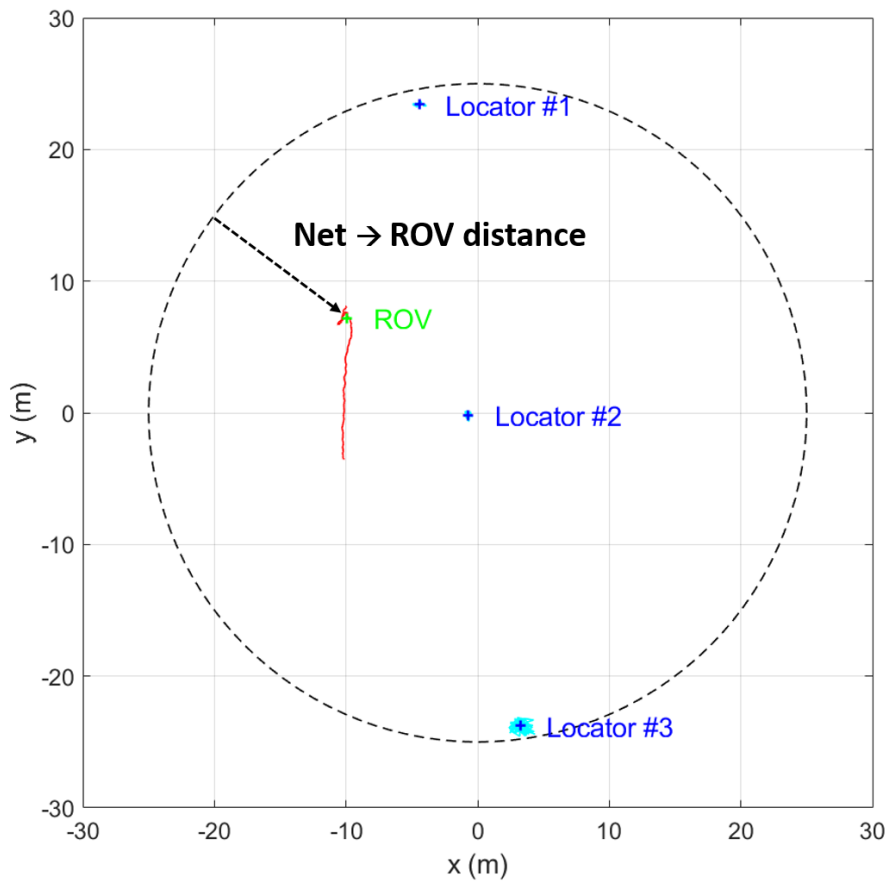


**Figure 3.37** An example of the time series of measured positions with higher noise level

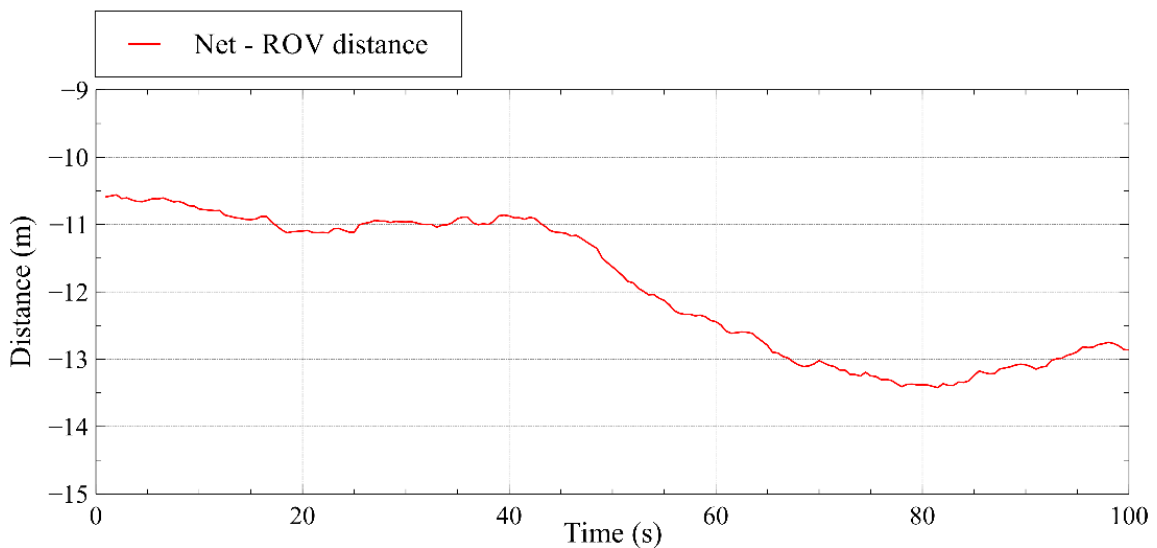


**Figure 3.38** Errors of the estimated positions relative to the measured ones (corresponding to Figure 3.37)

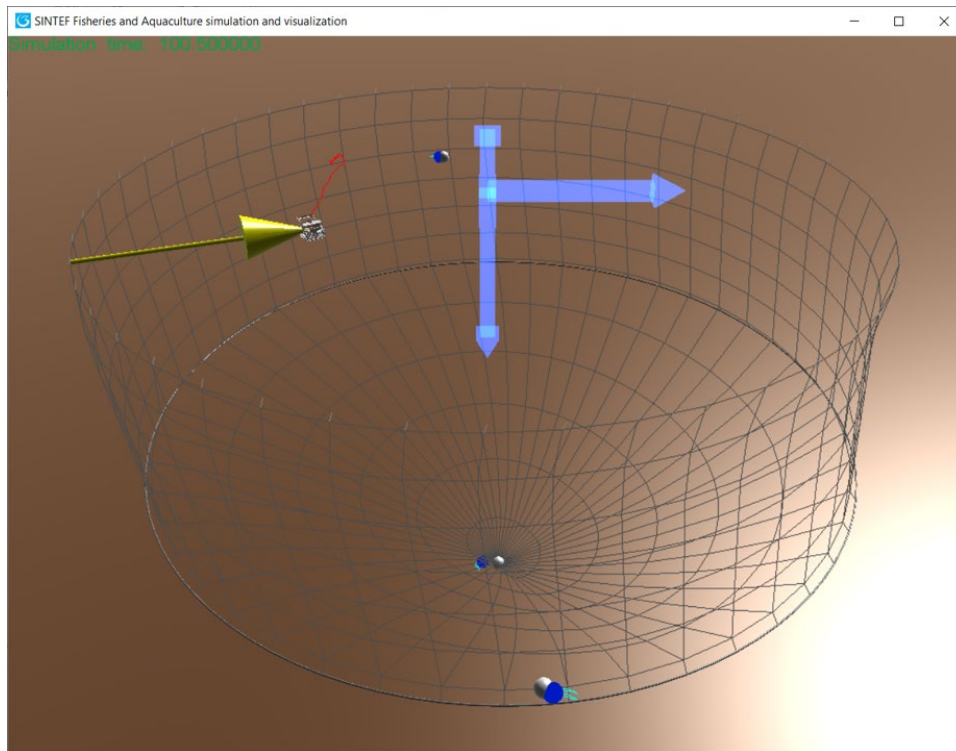
The estimation model is furthermore able to calculate the distance between the ROV and the closest net panel, considering net deformation and measured positions of the ROV. Figure 39 shows an example of the recorded trajectories of the ROV and the three locators on the cage, where the ROV was first aiming to keep a constant position (Figure 39) and then follow a straight line (Figure 39) by using a DP (dynamic positioning) controller (Fossen 2011). The calculated distance between the ROV and the net is shown in Figure 40, where the ROV was aiming to keep its position in the first 40 seconds and follow a straight line afterwards. Herein the minus distance means the ROV is inside the cage: when following the straight line it was moving further away from the net before it reached the central line of the cage and then moving closer to the net on the other side. By taking into account net deformation and the resulting orientation of surrounding net panels, this result is reasonably accurate and shown to be suitable for autonomous net-following navigation. As shown in Figure 41, all the measured data and estimation results can be instantaneously visualized in FhSim, which is also useful for real-time applications with regards to both autonomous navigation and manual operations. During the field trial, FhSim had been used as a tool to display cage deformation and for instant observation of the distance between the ROV and the net.



**Figure 39** An example of the recorded trajectories of the ROV and the three locators on the net cage where the green cross denotes the constant position from the net and the red line denotes the followed straight line by the ROV



**Figure 40** Time series of the calculated distance (minus distance means the ROV is inside the cage) between the ROV and the closest net panel (corresponding to Figure 24)



**Figure 41 Real-time visualization of net deformation and ROV operations in FhSim (corresponding to Figure 24)**

## 4 Conclusion

This report presents the development and validation of a low cost and hydroacoustic subsea communication system adapted for use in the cage. In particular, the obtained experimental data have been used to develop and validate numerical methods that estimate a high-resolution real-time map of the fish cage. The developed underwater positioning system from WaterLinkes AS (i.e. wLink) have been used in combination with numerical methods to realize a position reference system, and the research need lies in developing a wLink configuration that provides good performance in combination with the numerical methods. The position reference system is validated through multiple trial series where positioning accuracy is validated. The obtained results both for the real-time map estimation and underwater positioning of the vehicle showed good accuracy and will be further used for autonomous navigation concepts of underwater vehicle moving in the cage that are developed in this project.

## 5 References

- B., **Su** et al., 2019. A multipurpose framework for modelling and simulation of marine aquaculture systems. In Proc. ASME 38th International Conference on Ocean, Offshore and Arctic Engineering (OMAE 2019), 2019.
- G., **Einicke** and L., White, 1999. Robust extended Kalman filtering. IEEE Transactions on Signal Processing, Volume 47, pp. 2596–2599.
- T. I. **Fossen**, Handbook of Marine Craft Hydrodynamics and Motion Control. John Wiley & Sons, Ltd, 2011.
- K.-J. **Reite** et al., 2016. FHSIM - Time Domain Simulation of Marine Systems. In Proc. ASME 33rd International Conference on Ocean, Offshore and Arctic Engineering (OMAE 2014), 2014.
- P. **Rundtop** and K. Frank., 2016 Experimental evaluation of hydroacoustic instruments for ROV navigation along aquaculture net pens. Aquacultural Engineering, Volume 74, September 2016.



## A Appendix: Installation in Hosnaøyen

Appendix A describes the procedures for the installation of the WaterLinked positioning system at Hosnaøyen in June 2018. The aim for installing the system was to test the positioning system over time and to provide input to SINTEF's net structure estimator, as described in this report. The following steps for the installation were performed:

- Three locators were installed at the cage. All locators were attached at the top of the cage (Figure A1) and the cables were led between the net and the lice skirt.



**Figure A1 Transmission of the cable for the locator between the net and the lice skirt**

- Locator 1 was installed at 30 m depth where it was attached to a rope connecting the cage tip to the center weight using cable ties. The cable was attached with cable ties to the rope connecting the bottom ring to the net with some meter slack to prevent potential damage to the cable by movement.
- Locator 2 was installed at 6.5 m depth, where it was attached to the lifting rope of the lower edge of the lice skirt.
- Locator 3 was installed at 17.5 m depth, where it was attached to the rope connecting the bottom ring to the net using cable ties.
- Above the water line, all locator cables were taped along the handrail of the cage leading to the cabinet (Figure A2). Slack between the attachments prevented potential damage to the cables.
- Installation of receiver's kit, consisting of four hydrophones, along the cage:
  - The four hydrophones (named as Receivers #1-4) were distributed over four handrail post in proximity of the cabinet (Figure A3).
  - This was done by hanging a rope on each of these handrail posts and attaching a hydrophone from each kit to it (Figure A3). Two hydrophones were installed at 2 m depth, and two at 4 m depth (Figure A3).

The illustration of the full installation is shown in Figure A4

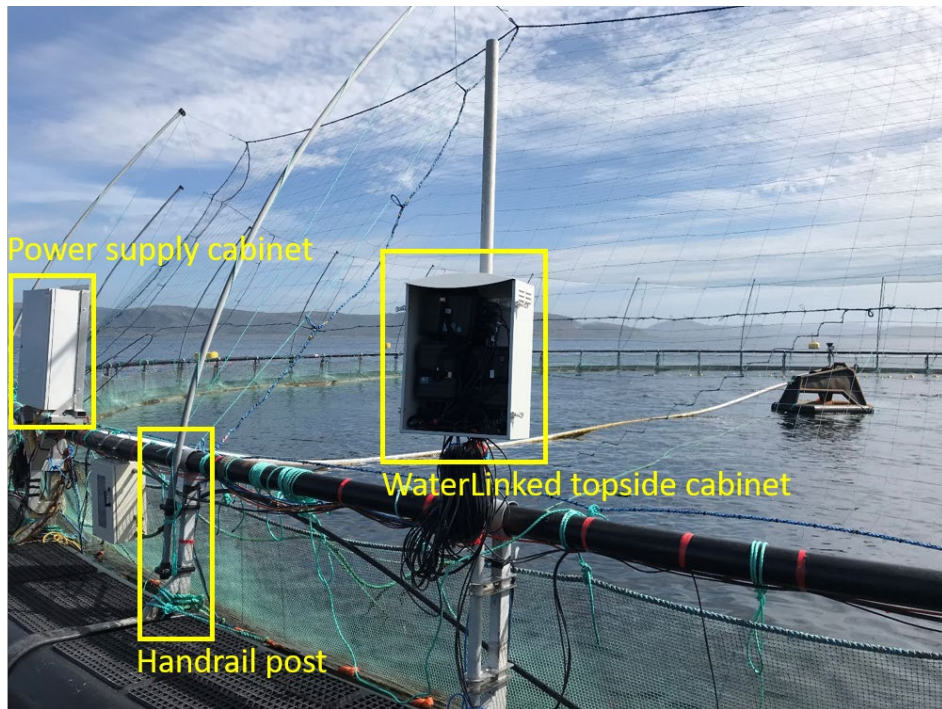


Figure A2 The cabinet containing WaterLinked's equipment (right) and the power cabinet that supplied power to the cage (left)

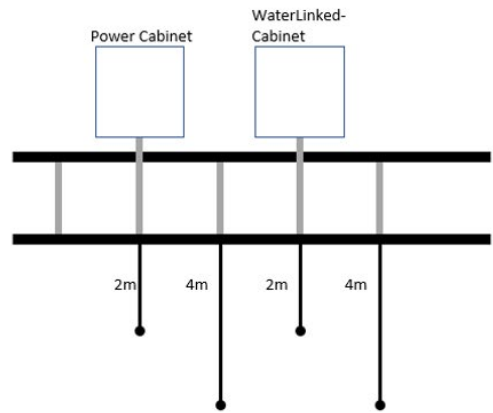
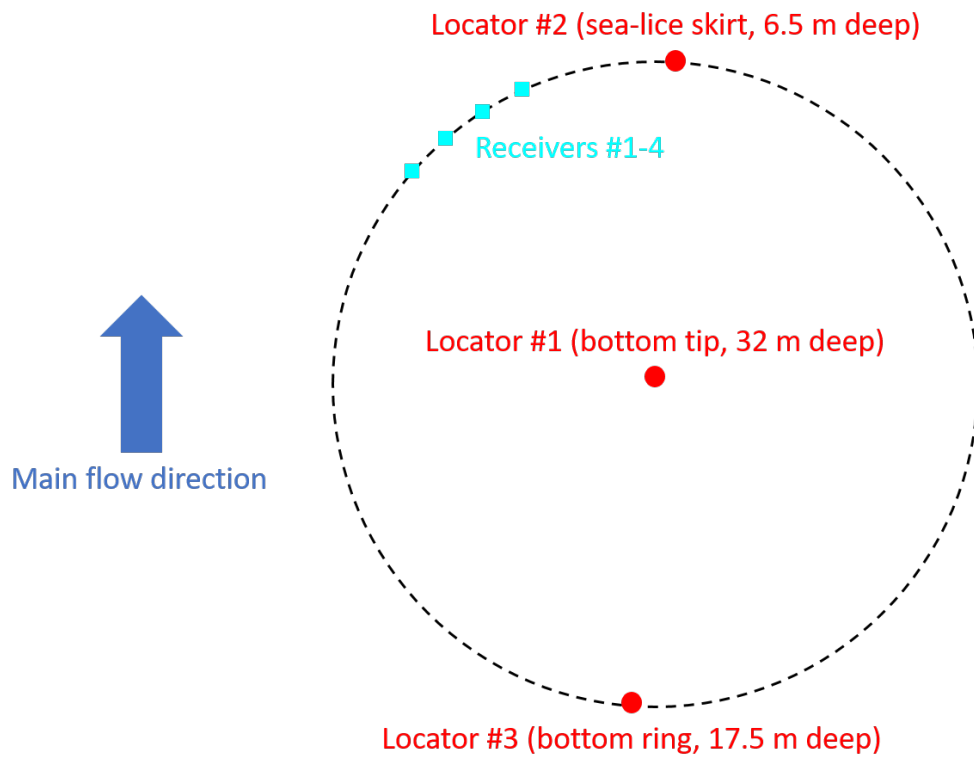


Figure A3 Left: cable coil with a locator from each of the three kits; Right: schematic description of the exposure of hydrophones to receiver kits at 2 and 4 m deep



**Figure A4 Schematic description of full installation**



## B Appendix: Installation in Rataren

Appendix B describes the procedures for the installation of the WaterLinked positioning system at Rataren in June 2019. The aim for installing the system was to test the positioning system over time and to provide input to SINTEF's net structure estimator, as described in this report. The following steps for the installation were performed:

- Three locators were installed at the cage. All locators were attached at the top of the cage (Figure B1) and the cables were led between the net and lice skirt
- Locator # 1 was attached to the edge of the lice skirt at a depth of 6.3 m (Figure B2, bottom).
- Locator # 2 was attached to bottom ring in 32 m depth (Figure B2, left).
- Locator # 3 was mounted on the rope between the bottom ring and the net in 16.2 m depth (Figure B2, right).
- All locator cables were taped along the handrail of the cage leading to the cabinet. Slack between the attachments prevented potential damage to the cables.
- Setup of four receivers
  - The receivers were placed along a rope connecting two points along the walkway (xm distance) and hanging down to 6 m depth in the middle where a weight was attached (Figure B3 and Figure B4). On each side of the weight two of the receivers were placed at 2 m and 4 m depth
  - The cables were connected to the cabinet (Figure B5).
  - The complete system was set up as indicated in Figure B6.

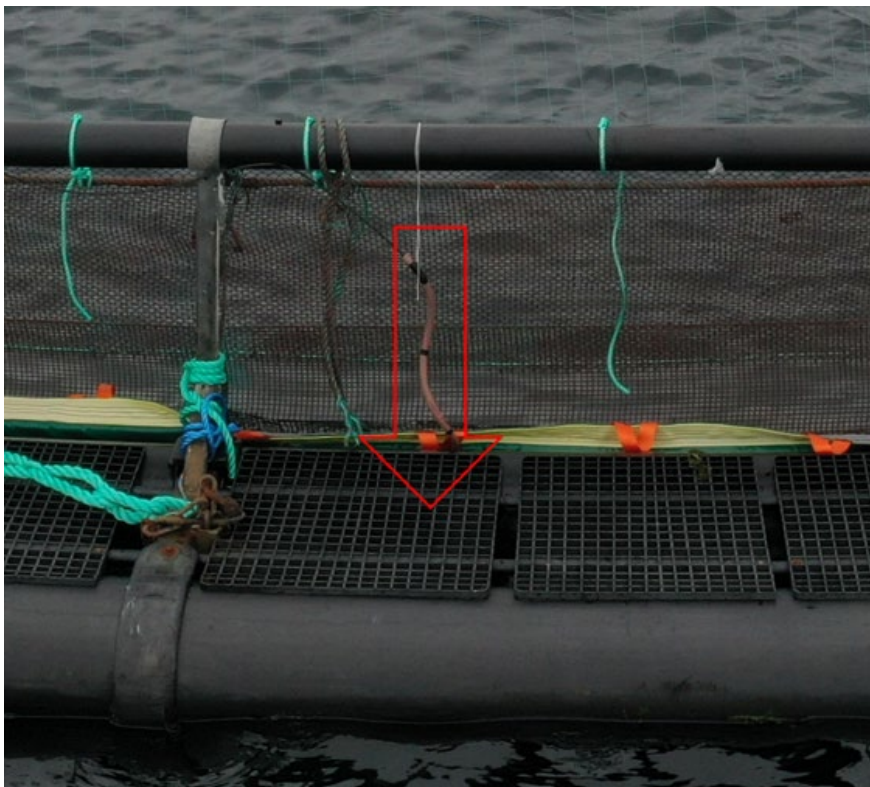


Figure B1 Transmission of cable for the locator between the net and the lice skirt



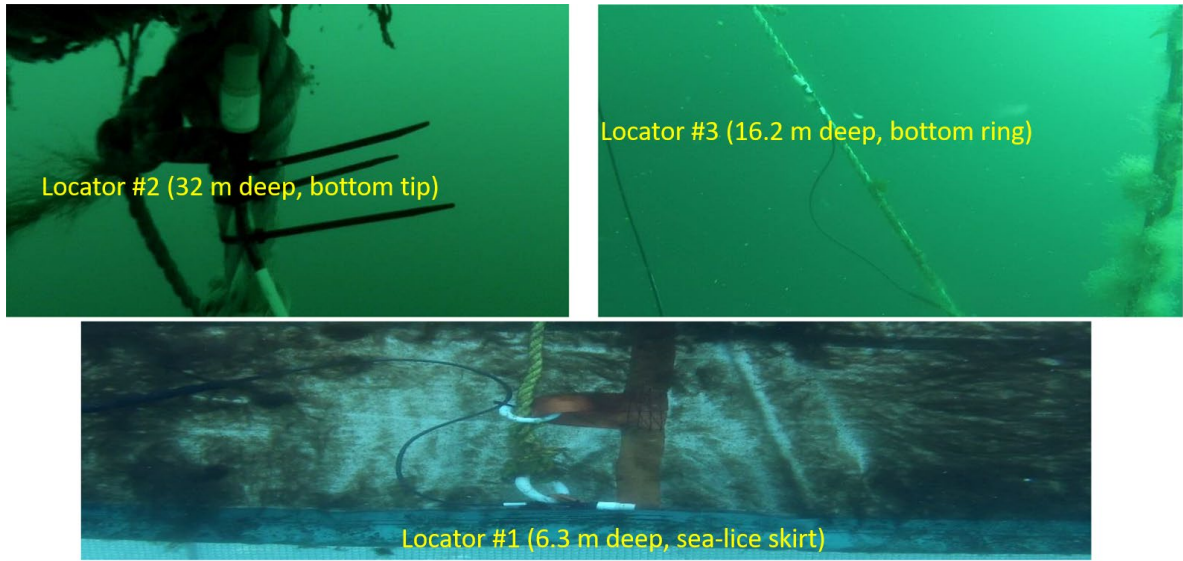


Figure B2 Photos of the installed locators

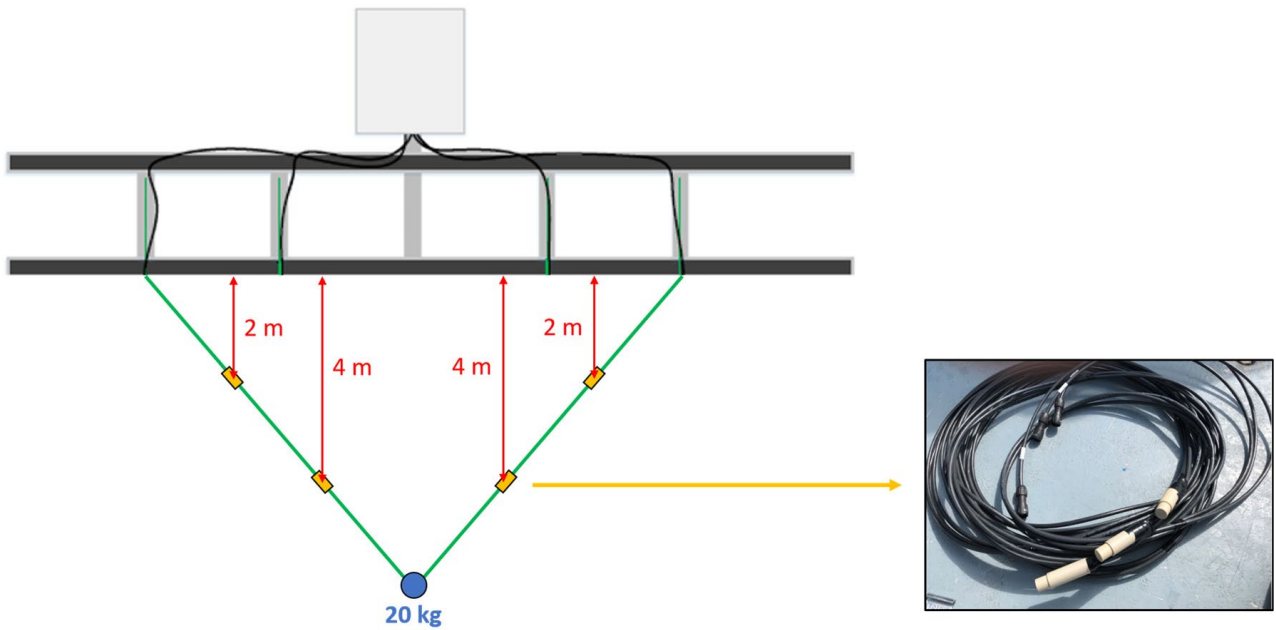


Figure B3 Schematic description of the installation of four receivers at 2 and 4 m depth

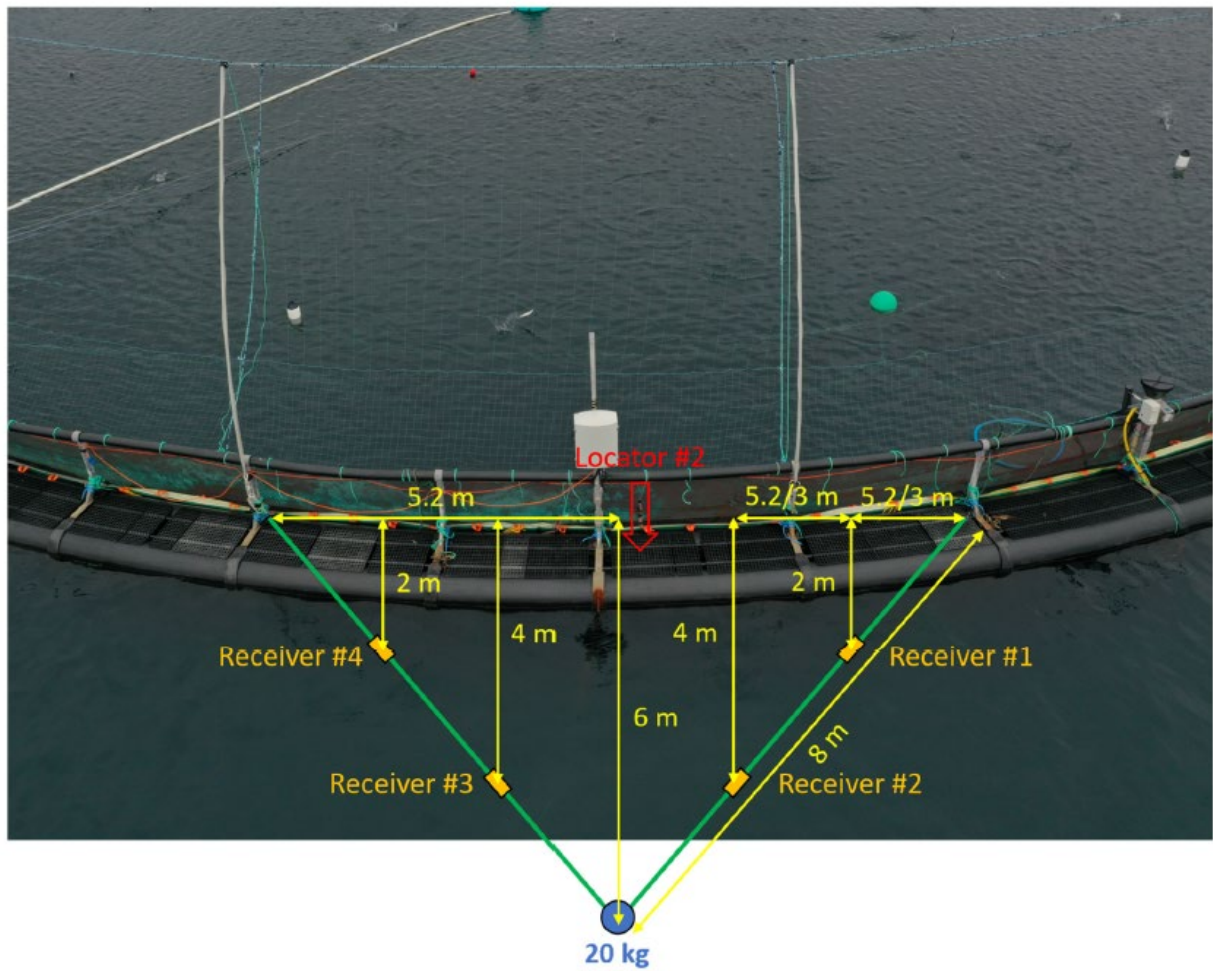
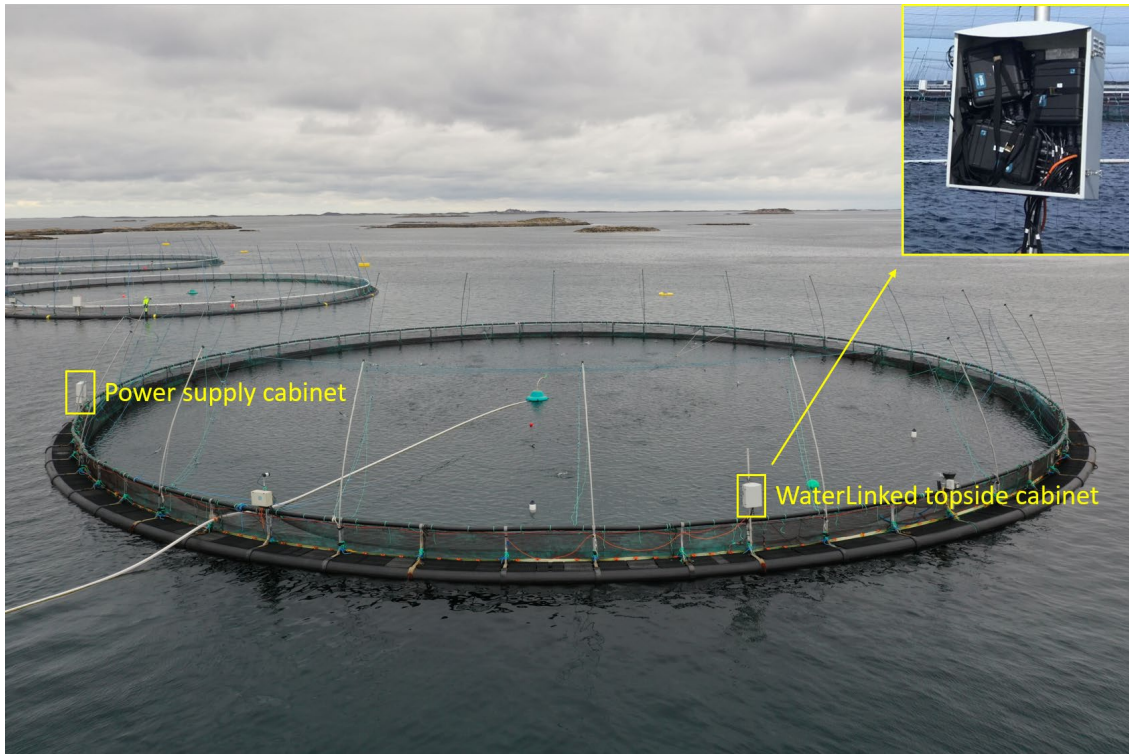
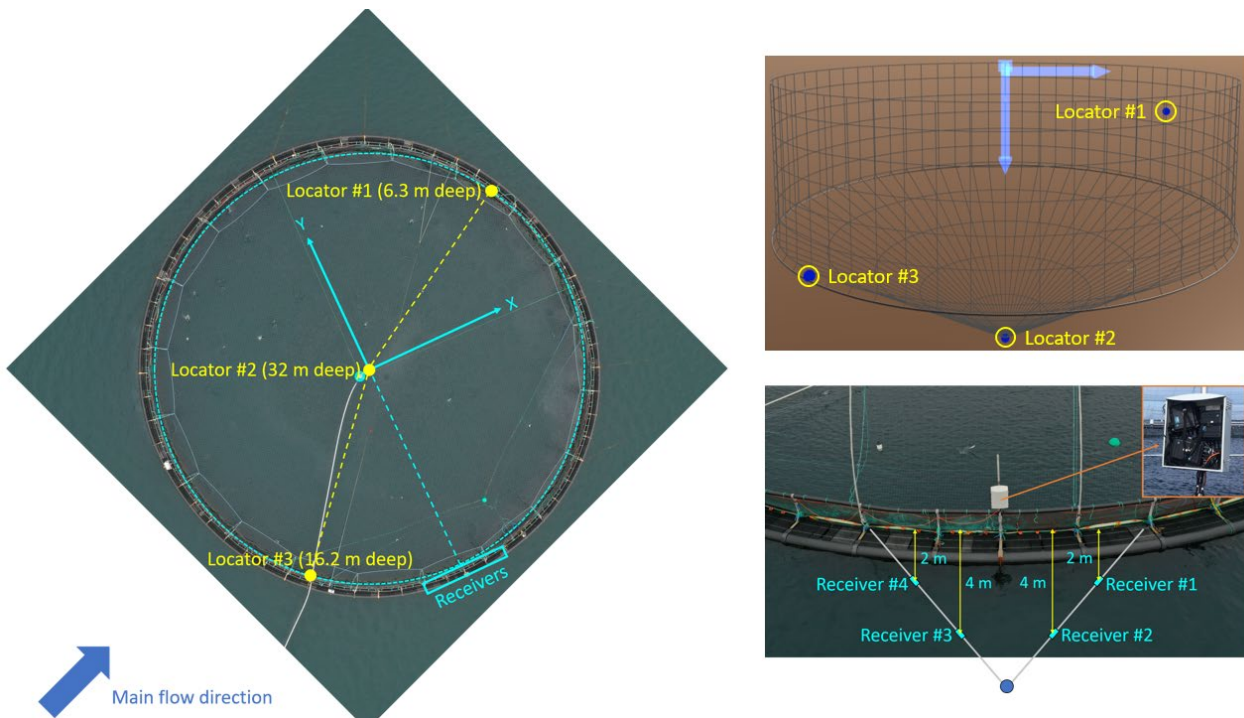


Figure B4 Illustration of the setup for Receivers #1-4 and Locator #2



**Figure B5** WaterLinked's cabinet and the power supply cabinet



**Figure B6** Schematic description of the full setup at the site