

Performance Investigation of a Multi-Ejector R744 Heat Pump

Singh, Simarpreet^(a); Reddy, Amshith^(a); Maiya P. Prakash^(a), Banasiak, Krzysztof^(b);
Hafner, Armin^(c); Neksa, Petter^(b);

^(a)*IIT Madras, 600036, India.*

^(b)*SINTEF Energy Research Trondheim, 7034, Norway.*

^(c)*NTNU, Trondheim, 7034, Norway.*

ABSTRACT

Carbon dioxide (CO₂, R744) is a natural refrigerant which is emerging as a potential substitute for Hydrofluorocarbons (HFCs) and FCs nowadays because of its eco-friendliness, non-flammability, high volumetric capacity and good heat transfer properties. The demand for domestic water heating is growing rapidly in India for applications like dairies, hotels, hospitals etc. Trans-critical R744 system with heat recovery seems to be appropriate for such application. The drawbacks of lower efficiency and the demand mismatch can be improved by incorporating ejectors; while, the mismatch is addressed by suitable control and standby gas cooler respectively. The paper presents an experimental evaluation of an R744 multi-ejector based system with heat recovery for hot water production. The effect of high ambient temperature (36-46°C) on the overall performance of the system and heat recovery is also evaluated. It is observed that the COP of the multi-ejector R744 system with heat recovery for domestic production at high ambient context is high. Also, the opportunity of maximum heat available for recovery is encouraging to accept this technology for high ambient context.

Keywords: Natural refrigerant; Trans-critical cycle; Ejector; CO₂

1. INTRODUCTION

R744 was identified as the auspicious refrigerant option by Prof. Lorentzen for various applications such as automobile air conditioning, residential heating and water heating (Lorentzen, 1994). R744 system is popular for residential heating applications in colder climate (Richter et al., 2003). But, the performance of the system was not comparable with the synthetic refrigerants in warm weather due to the presence of large throttling losses. Various modifications of the basic vapor compression system were proposed and reported, so far, in order to improve the overall performance of the R744 system. The modifications also incorporate; two-phase ejectors (Banasiak and Hafner, 2013) and work recovery expanders (Singh and Dasgupta, 2016). Ejector is considered as the appropriate option as compare to the work recovery expanders due to lack of moving parts. Additionally, the pressure lift gained through the ejector reduces the compressor work as reported (Minetto et al., 2013).

A comparative simulation based study was carried out using R744 and R134a for a tap water heater application (Cecchinato et al., 2005). It was reported that the system with R744 is an impressive substitute for synthetic refrigerant for heating application. Later, an experimental investigation was carried out to find an optimum ejector geometry for a CO₂ based heat pump system (Banasiak et al., 2012). The mixer length and divergence angle of diffuser were the most influential parameters as projected in the study. It was also concluded that the overall performance of the system with ejector was improved maximum by 8% with respect to conventional vapor compression system equipped with an expansion valve. A prototype for R744 refrigeration system was developed to study various possibilities of COP improvement for residential tap water heating application. The system was typically analyzed for a Japanese shoulder season. Maximum COP reported for heating water from 17°C to 65°C was 6.0 (Saikawa and Koyama, 2016). In the same year, an another experimental study

was carried out covering three applications such as; for winter heating, summer cooling and tap water production simultaneously (Minetto et al., 2016). It was observed and reported that the R744 based system equipped with ejector improves the overall performance of the system as compared to the conventional R410A system. Recently, an attempt was also made to use R744 heat pump system as a heat recovery system in process dairy industry to further use it for pre-heating the boiler feed water (Singh and Dasgupta, 2017). It was reported that the R744 system can be effectively used to couple the existing ammonia-based refrigeration system and boiler system for heat recovery.

The focus of this study is to increase the applicability of R744 multi-ejector based system with heat recovery for hot water production at high temperature context such as India. The performance of the ejector based R744 heat pump system with various parameters such as gascooler capacity, COP, heat recovery, optimum gascooler pressure and optimum entrainment ratio of ejector are investigated experimentally and projected in this study.

2. DESCRIPTION OF R744 SYSTEM

A fully instrumented R744 test facility of 33 kW capacity is designed to maintain three different levels of temperatures such as freezing (-29°C), refrigeration (-6°C) and air conditioning ($7-9^{\circ}\text{C}$). The test facility is equipped with the heat recovery system to maintain a constant heat load demand (Figure 1). Load of MT and LT evaporators are controlled by manually operated EEV installed before glycol suction port to the evaporator. Propylene glycol-water solution is used as a heat transfer medium in the test facility. Two separate glycol loop circuits are arranged with different glycol concentrations; 42% for MT & AC load and 56% for LT load. Shell-tube design evaporator and air-cooled gas cooler with tube-fin design is installed in the supermarket facility.

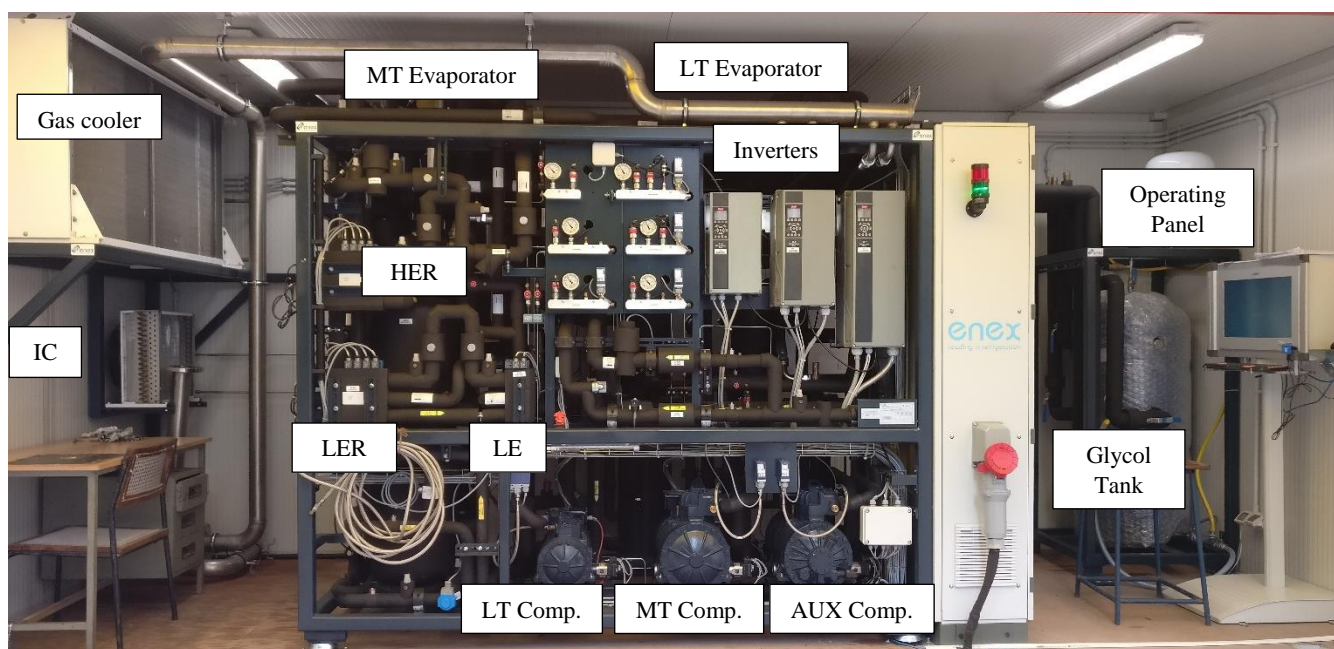

Figure 1. R744 system for supermarket application.

Three compressors are arranged to compromise LT & MT compressor and AUX compressor is installed to handle high amounts of flash gas which also enables parallel compression operation. Two ejectors are installed with low ejection ratio (LER), high ejection ratio (HER). One liquid suction accumulator is also installed in order to provide an excess feed to over feed the evaporators throughout

the year. Temperature sensors, pressure sensors and energy meters are installed at various locations to evaluate the performance of the system and examine the various parametric variations. Test-rig also facilitates seven different modes of operation and it is so designed in order to evaluate various possible configurations for supermarket application at high ambient temperature (upto 46°C).

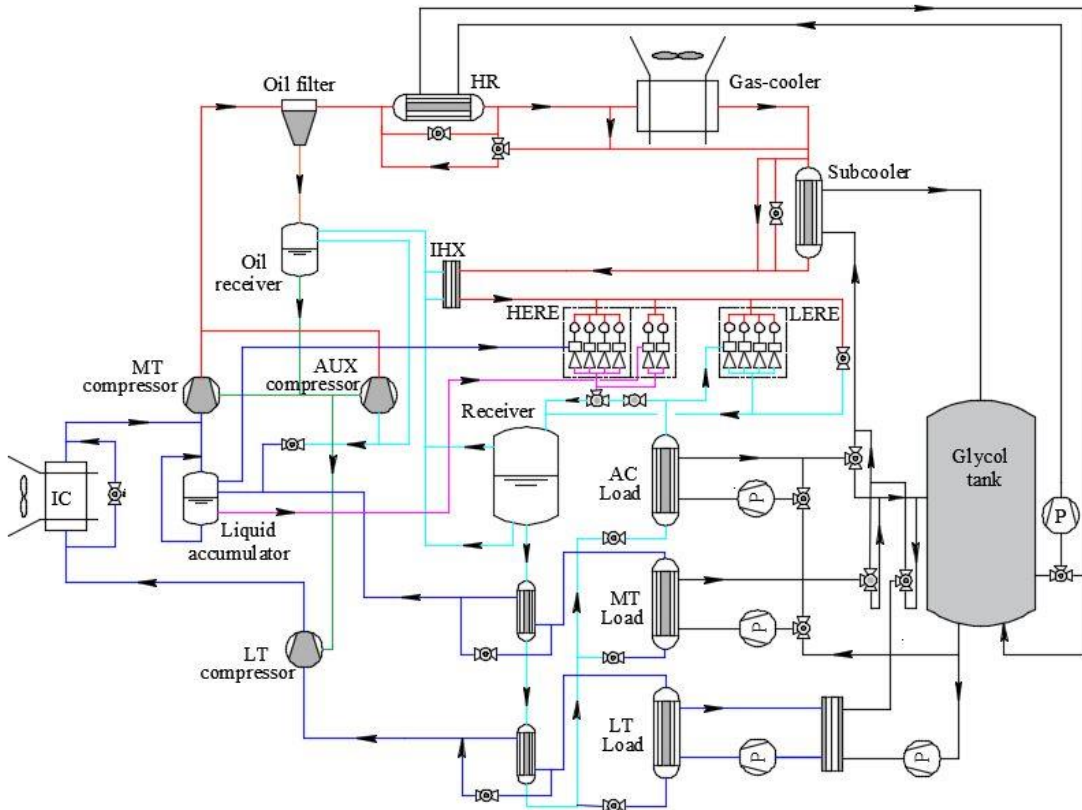

Figure 2. Schematic of the R744 system.

Figure (2) shows the detailed schematic of the R744 facility projecting various components installed in the test system. Among the seven modes available, the mode used for the present study incorporated single AC evaporator with high ejection ratio two-phase ejector, an AUX compressor to manage the pressure lift and a receiver or separator is investigated for the present study.

3. PERFORMANCE EVALUATION

The system performance is evaluated for each gas cooler outlet temperature after achieving the steady state which needs ~30 minutes. Hourly based data extracted for a required single gas cooler outlet temperature and averaged value of the various parameters is used for the performance evaluation. Performance of the system is projected and R744 system configuration used for the present study is shown in Figure (3) and its ideal Ph plot representing is shown in Figure (4). Points (1-10) highlights the corresponding enthalpy values at that specific state point of R744 system. Parameters used for performance evaluation of ejector based R744 system are tabulated in Table 1 and Table 2 respectively.

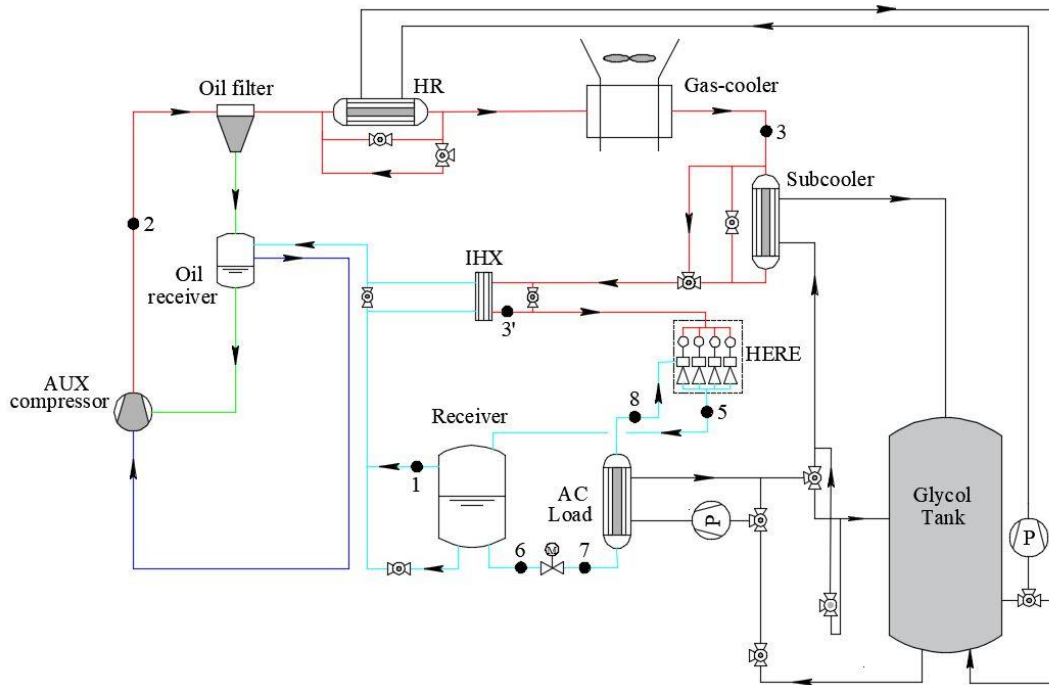

Figure 3: Configuration of R744 system evaluated.

Table 1. R744 System details.

Component	Details	Units	Value/Range
Gas cooler	Designed capacity	kW	54.11
	Cooling medium		Air
	Heat exchanger type		Fin-tube
	Pipe material		Copper
	Fin material		Aluminum
	Outer pipe diameter	mm	8.27
	Inner pipe diameter	mm	7.87
	Pipe length	mm	1620.50
Compressor	Coil stacks		4
	Design		Reciprocating
Evaporator	Cooling oil		PAG, Daphere hermetic oil PR
	Capacity	kW	20
	Design		Tube-in-tube
	Tube material		Copper

Table 2. Parameters used for performance evaluation.

Parameter	Units	Value/Range
Gas cooler outlet temperature	°C	36-46
Gas cooler outlet pressure	Bar	80-120
Evaporator temperature	°C	7-9
Receiver pressure	Bar	45

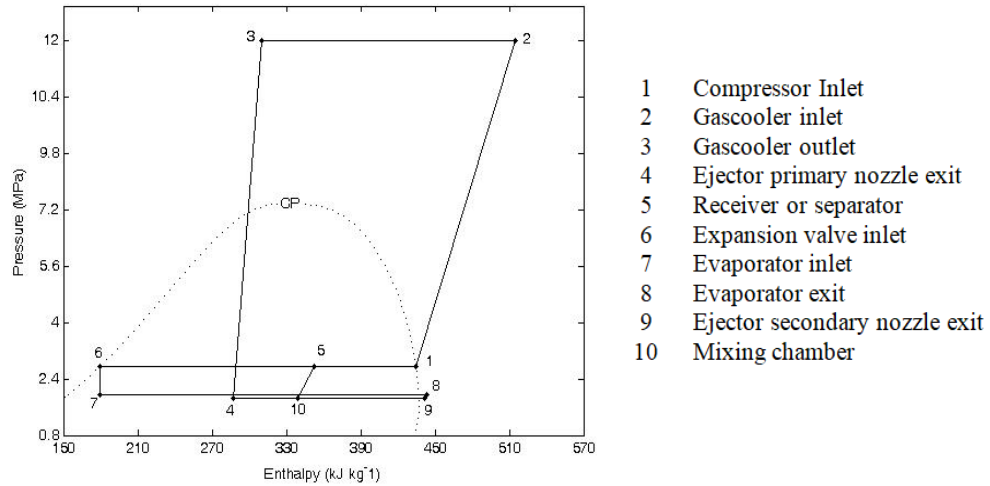

Figure 4. Ph plot of the system.

3.1. DATA REDUCTION

Performance of the ejector based R744 system for heat pump at high ambient temperature is computed using Eqs. (1-4):

Evaporator load (AC) of the system is computed using Eq. 1.

$$\dot{Q}_{evap} = \dot{v}ol * \rho * c_p * (T_{evap_out} - T_{evap_in}) \quad (1)$$

Maximum heat recovery from the heat pump system is computed using Eq. 2.

$$\dot{Q}_{hr} = \dot{v}ol * \rho * c_p * (T_{hr_out} - T_{hr_in}) \quad (2)$$

COP of the R744 system is computing using Eq. 3.

$$COP = \frac{Q_{evap} + Q_{hr}}{WD_{comp.}} \quad (3)$$

Ejector entrainment ratio (μ) of the system is computed using Eq. 4.

$$\mu = \frac{m_{evap_R744}}{m_{gc_R744}} \quad (4)$$

4. RESULTS AND DISCUSSION

Figure (5) shows the COP (system and cooling) with respect to gas cooler outlet temperature at optimum discharge pressure. It is observed that as the gas cooler outlet temperature increases, the optimum discharge pressure of the system also increases due to the S shape isotherm restriction. Also, the compressor work increases along with the heat recovery by the system, keeping the AC evaporator load constant. However, the increase in AUX compressor work is more than the heat recovery from the system at high ambient temperature and hence the COP decreases as the gas cooler temperature increases. The maximum COP observed for the system and cooling are approximately 7.2 and 4 respectively.

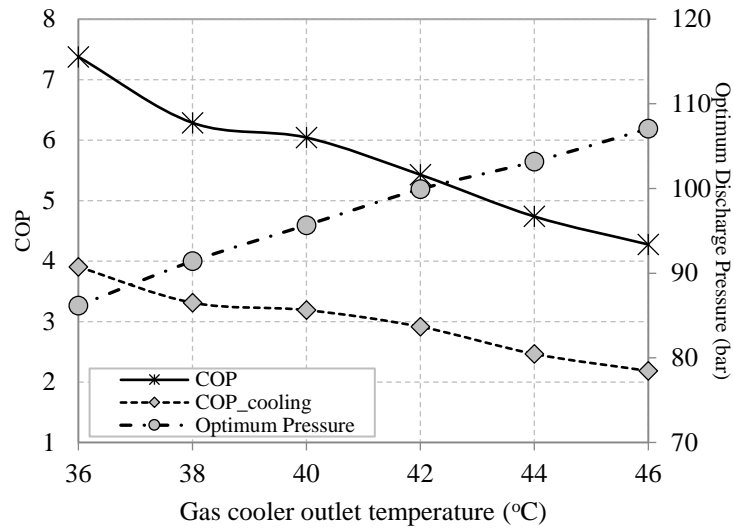

Figure 5. COP and optimum gascooler discharge pressure with gas cooler outlet temperature.

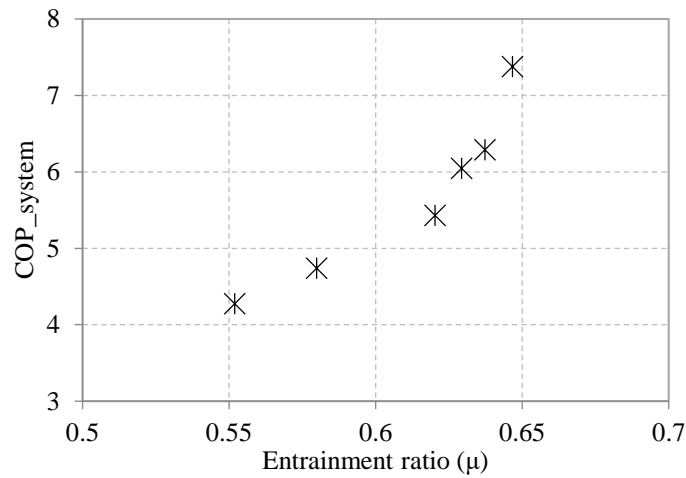

Figure 6. Ejector entrainment ratio and glycol inlet temperature with maximum COP.

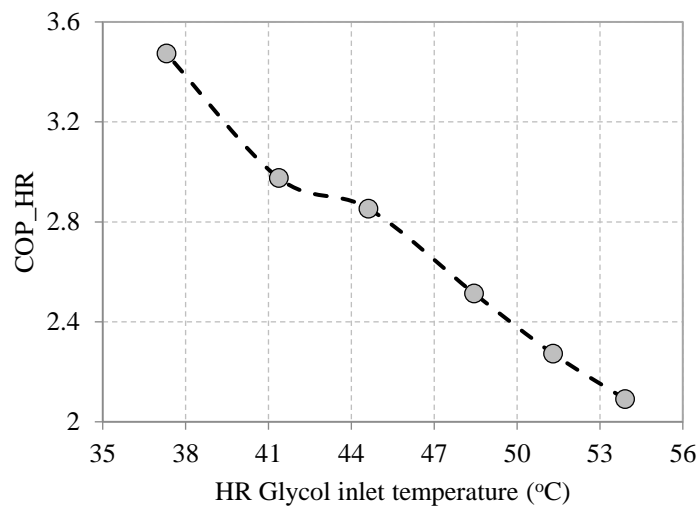

Figure 7. COP of the system for heat recovery with glycol inlet temperature.

Variation of COP of the system with the ejector entrainment ratio is shown in Figure (6). It is observed that, as the entrainment ratio increases, the ejector motive flow (primary flow) reduces due to the constant evaporator load. As a consequence, both compressor power and amount of heat recovered decreased. As a result, COP of the system increases.

Variation of COP of the system for heat recovery with glycol inlet temperature is shown in Figure (7). It is observed that, as the glycol inlet temperature to the heat recovery system increases, the amount of heat recovered increases due to the better heat transfer characteristics of R744 at high ambient temperature and also the compressor power increases. But due to increased compressor power at high ambient temperature, system COP decreased.

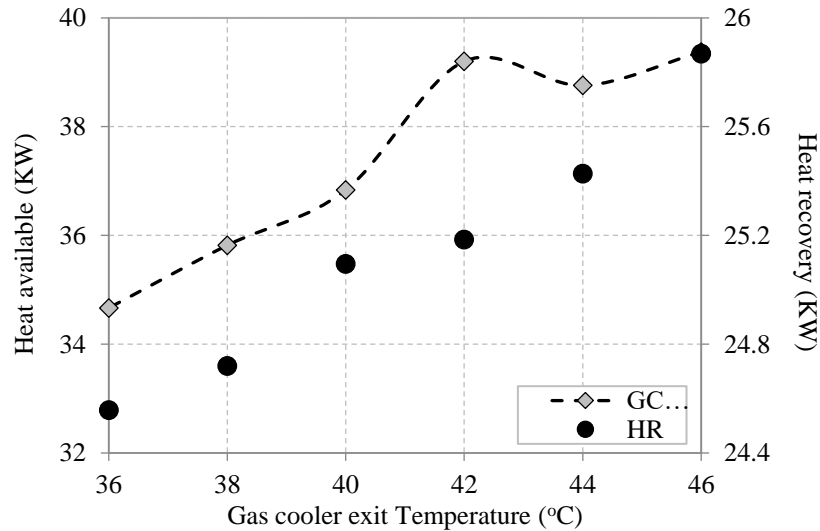

Figure 8. Heat available and heat recovery with gas cooler outlet temperature.

Figure (8) shows the maximum heat available at the gas cooler and the heat recovered through the heat recovery system with glycol loop at various gas cooler outlet temperatures. It is observed that as the gas cooler outlet temperature increases, the compressor work increases. Hence the temperature and the pressure lift by the compressor increases and due to which high heat extraction is possible from the gas cooler as well as from heat recovery system at high ambient temperature. It is also observed that the heat available at gas cooler is almost double as we have recovered from the heat recovery system. This can be considered as the prominent option to use it for hot water production.

5. CONCLUSIONS

An experimental evaluation is carried out in order to evaluate the performance of the R744 ejector based system at high climatic context (36-46°C). The following conclusions are drawn from the present study:

- Maximum COP observed for the system and cooling are approximately 7.2 and 4 respectively at high ambient context range (36-46°C) including heat recovery.
- Increasing entrainment ratio effects on reduction in compressor power used by the system and also the amount of heat recovered.
- Heat recovery from the system increases as the glycol inlet temperature to the system increases.
- COP of the system decreases due to increased compressor power at high ambient temperature, as compressor power has dominating effect than the heat recovery on the overall performance of the system.

- Heat recovery at gas cooler is considered as the prominent option and can be use it further for hot water production application simultaneously.

Acknowledgements

The work presented is part of an ongoing Indo-Norwegian project funded by the Ministry of Foreign Affairs, Government of Norway coordinated by SINTEF, Norway. The Indian authors also thank the additional support received from Department of Science and Technology (DST) under project: PDF/2017/000083.

Nomenclature

\dot{Q}	Heat transfer rate	(kW)	<i>evap</i>	Evaporator
\dot{m}	Mass flow rate	(kg s ⁻¹)	<i>gc</i>	Gas cooler
$\dot{v}ol$	Volume flow rate	(m ³ s ⁻¹)	<i>hr</i>	Heat recovery
ρ	Density		<i>in</i>	Inlet
<i>comp</i>	Compressor		<i>out</i>	Outlet
<i>COP</i>	Coefficient of Performance		<i>WD</i>	Work Done

References

- Banasiak, K., Hafner, A., 2013. Mathematical modelling of supersonic two-phase R744 flows through converging-diverging nozzles: The effects of phase transition models. *Appl. Therm. Eng.* 51, 635–643.
- Banasiak, K., Hafner, A., Andresen, T., 2012. Experimental and numerical investigation of the influence of the two-phase ejector geometry on the performance of the R744 heat pump. *Int. J. Refrig.* 35, 1617–1625.
- Cecchinato, L., Corradi, M., Fornasieri, E., Zamboni, L., 2005. Carbon dioxide as refrigerant for tap water heat pumps: A comparison with the traditional solution. *Int. J. Refrig.* 28, 1250–1258.
- Lorentzen, G., 1994. Revival of carbon dioxide as a refrigerant. *Int. J. Refrig.* 17, 292–301.
- Minetto, S., Brignoli, R., Banasiak, K., Hafner, A., Zilio, C., 2013. Performance assessment of an off-the-shelf R744 heat pump equipped with an ejector. *Appl. Therm. Eng.* 59, 568–575.
- Minetto, S., Cecchinato, L., Brignoli, R., Marinetti, S., Rossetti, A., 2016. Water-side reversible CO₂ heat pump for residential application. *Int. J. Refrig.* 63, 237–250.
- Richter, M.R., Song, S.M., Yin, J.M., Kim, M.H., Bullard, C.W., Hrnjak, P.S., 2003. Experimental results of transcritical CO₂ heat pump for residential application. *Energy* 28, 1005–1019.
- Saikawa, M., Koyama, S., 2016. Thermodynamic analysis of vapor compression heat pump cycle for tap water heating and development of CO₂ heat pump water heater for residential use. *Appl. Therm. Eng.* 106, 1236–1243.
- Singh, S., Dasgupta, M.S., 2017. CO₂ heat pump for waste heat recovery and utilization in dairy industry with ammonia based refrigeration. *Int. J. Refrig.* 78, 108–120.
- Singh, S., Dasgupta, M.S., 2016. Evaluation of research on CO₂ trans-critical work recovery expander using multi attribute decision making methods. *Renew. Sustain. Energy Rev.* 59, 119–129.