



CommONEnergy



# DELIVERABLE 7.12

## Guidelines on retrofitting of shopping malls

**European Commission  
DG Research and Innovation**

SP1 - Cooperation

Collaborative project

Large-scale integrating project

FP7-2013-NMP-ENV-EeB

GRANT AGREEMENT No. 608678

*CommONEnergy*

*Re-conceptualize shopping malls from consumerism to energy conservation*

## Technical References

Project Acronym	CommONEnergy
Project Title	Re-conceptualize shopping malls from consumerism to energy conservation
Project Coordinator	Roberto Lollini Accademia Europea Bolzano, Viale Druso 1, 39100 Bolzano/Italy roberto.lollini@eurac.edu
Project Duration	1 October 2013 – 30 September 2017 (48 Months)

Deliverable No.	D7.12 - Guidelines on retrofitting of shopping malls
Dissemination Level	PU
Work Package	WP7
Lead beneficiary	EURAC
Contributing beneficiary(ies)	All partners
Author(s)	Roberto Lollini & others
Co-author(s)	N/A
Reviewed by	N/A
Date	30 September 2017
File Name	WP7_D7.12_20170703_Guidelines on retrofitting of shopping malls

**This document has been produced in the context of the CommONEnergy Project.**

The research leading to these results has received funding from the European Community's Seventh Framework Programme (FP7/2007-2013) under grant agreement n. 608678. The content of this document does not reflect the official opinion of the European Union. Responsibility for the information and views expressed in the document lies entirely with the authors.

## Executive summary

A shopping centre is a building, or a complex of buildings, designed and built to contain many interconnected activities in different areas. Shopping centres have special peculiarities as they vary in their functions, typologies, forms and size. Within the retail sector, they are of particular interest because of their structural complexity and multi-stakeholders' decisional process, their high energy savings potential and carbon emissions reduction, as well as their importance and influence. In order to efficiently exploit a shopping centre energy potential, every retrofitting should involve a careful analysis of the building peculiarities in all fields, from the economic features to the socio-cultural ones. The use of building energy simulations can help evaluate the balance between gains and losses and the energy uses and test design options and solution-sets.

The CommONEnergy guidelines are a step-by-step handbook for the renovation of shopping centres, resulting from the four years of research of the project.

Starting from an analysis of shopping centres' features and drivers for their renovation, CommONEnergy guidelines go through processes, modelling and tools developed by the project, focusing in particular on the several technologies enabling the aggregation in cost-effective solution-sets, like greenery integration, multifunctional coating and demand-response approach for refrigeration. The tools described by the guidelines include the Economic Assessment Tool and the Integrated Design Process Library.

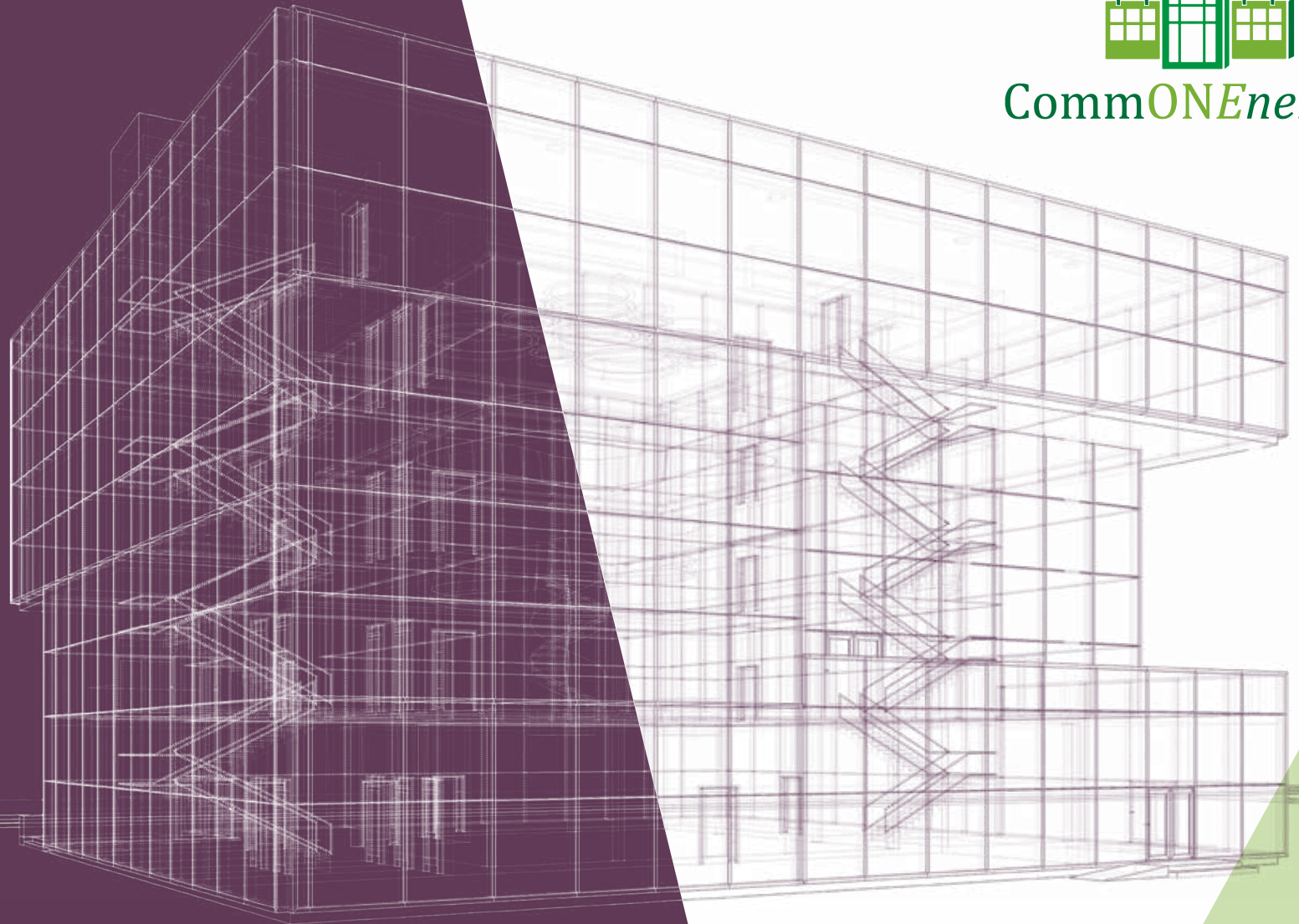
These guidelines can be key to launch a domino effect for the energy transition of shopping centres and similar buildings in the EU, such as airports or train stations.

The guidelines have been officially presented during the final event of the project, held in Brussels on September the 7<sup>th</sup>, 2017.

The pdf version is freely accessible on the project website at the following [link](#).



CommONEnergy



# **GUIDELINES**

ON HOW TO APPROACH  
THE ENERGY-EFFICIENT  
RETROFITTING OF  
SHOPPING CENTRES



**Mercado del Val, Valladolid, Spain.** Source: Mercado del Val.

The research leading to these results has received funding from the European Community's Seventh Framework Programme (FP7/2007-2013) under grant agreement n. 608678. The content of this document does not reflect the official opinion of the European Union. Responsibility for the information and views expressed in the document lies entirely with the authors.



### **Authors**

Marta Avantaggiato, Grazia Barchi, Annamaria Belleri,  
Chiara Dipasquale, Roberto Lollini, Wilmer Pasut (EURAC)

Matthias Haase (SINTEF)

Agne Toleikyte (TU Wien)

Francesca Lam Nang (INRES)

Magdalena Rozanska (ACCIONA)

Fotis Manesis (AMS)

Krzysztof Grabowiecki (CMS)

Antonio De Ferrari (D'APPOLONIA)

Andreas Ampenberger (BLL)

Federico Visconti (EPTA)

Paola D'Agaro, Giovanni Cortella, Onorio Saro (UNIUD)

Ivan Mangialenti, Stefano Mangili, Mara Martinelli,  
Sotirios Papantoniou (SCHNEIDER ELECTRIC)

Johannes Gantner (FRAUNHOFER-IBP)

### **Review and editing**

Giulia Paoletti (EURAC)

Marine Faber (BPIE)

Roberta D'Angiolella (BPIE)

### **Graphic design**

Ine Baillieul

# TABLE OF CONTENTS

<b>1</b>	<b>Foreword</b>	<b>6</b>
<b>2</b>	<b>Executive Summary</b>	<b>7</b>
<b>3</b>	<b>Introduction</b>	<b>14</b>
<b>4</b>	<b>EU building stock analysis</b>	<b>17</b>
4.1	EU shopping centre building stock scenarios	20
<b>5</b>	<b>Archetypes</b>	<b>25</b>
5.1	Building features	28
5.1.1	Structure	28
5.1.2	Roof and floors	28
5.1.3	Envelope	28
5.1.4	Insulation, waterproofing and coating	28
5.1.5	Windows/skylight	28
5.1.6	Technical systems	29
<b>6</b>	<b>Stakeholders</b>	<b>33</b>
6.1	Retrofitting drivers	35
<b>7</b>	<b>Integrated Design Process (IDP)</b>	<b>39</b>
7.1	Climate potential analysis	40
7.2	Assessment of retrofitting potential by means of Key Performance Indicators	42
7.3	Energy Audit	44
7.4	Modelling and dynamic simulations	44
7.5	Commissioning & post occupancy evaluation	45
7.6	Virtual Integrated Design Process (IDP) library	45
<b>8</b>	<b>Modelling to assess energy performance and comfort</b>	<b>49</b>
8.1	Modelling, simulation approach and tools	49
8.2	Integrative Modelling Environment	50
8.2.1	Building energy model	50
8.2.2	Building energy simulation	55
8.3	Modular structure of Integrative Modelling Environment	56
<b>9</b>	<b>Optimized building envelope and architecture</b>	<b>59</b>
9.1	Façade functions integration	59
9.1.1	Practical example	61
9.2	Multifunctional coating	63
9.2.1	Multifunctional coating additive	63
9.2.2	Picking of suitable characteristics	63
9.2.3	Characteristics evaluation	64
9.2.4	Application Guideline	64
9.3	Greenery integration	65

<b>10</b>	<b>Natural ventilation and ventilative cooling</b>	<b>69</b>
10.1	Case Studies	72
<b>11</b>	<b>Thermal environment in common areas</b>	<b>77</b>
<b>12</b>	<b>Acoustic environment</b>	<b>81</b>
<b>13</b>	<b>Lighting</b>	<b>83</b>
13.1	Lighting quality	83
13.2	Daylighting strategies	85
13.3	Efficient lighting Technologies	89
13.4	Lighting management	92
<b>14</b>	<b>Optimization of refrigeration cabinets area layout and technologies</b>	<b>95</b>
14.1	Energy efficient refrigeration cabinets	95
14.2	Configuration of area with display refrigeration cabinet and influence of heating and cooling distribution system	98
14.3	Air diffusers: effects on comfort and refrigeration cabinets	102
14.3.1	Full-air systems and traditional design (no energy saving)	102
14.3.2	Full-air systems and energy saving managing the risk of mist formation	104
<b>15</b>	<b>Novel energy distribution layout and generation technologies</b>	<b>107</b>
15.1	Use of Carbon dioxide (CO <sub>2</sub> ) heat pump in different climate conditions	107
15.1.1	CO <sub>2</sub> refrigerant characteristics	107
15.1.2	Trans-critical system for heat recovery	108
15.2	Coupling HVAC + refrigeration	111
15.2.1	Integration through heat recovery from the de-superheater	112
15.2.2	Integration through water reservoir	114
15.2.3	Integration to Water Loop Heat Pump system	116
15.3	Apply demand-response approach for refrigeration	118
<b>16</b>	<b>Smart supervision and management</b>	<b>121</b>
16.1	Intelligent Building Energy Management System (iBEMS)	121
16.2	Continuous commissioning (CC) platform procedure	124
<b>17</b>	<b>Local energy generation, grid interaction and storage</b>	<b>129</b>
17.1	RES exploitation	129
17.2	Electric mobility	131
<b>18</b>	<b>Impact assessment</b>	<b>133</b>
18.1	Assessment of environmental impact	134
18.2	Assessment of socio-cultural impact	137
<b>19</b>	<b>Development of retrofitting solution-sets</b>	<b>141</b>
19.1	Case studies: lesson learnt and standard reporting	145
<b>20</b>	<b>Conclusions</b>	<b>151</b>
<b>21</b>	<b>Additional sources of information on the topic</b>	<b>155</b>
	<b>Annex I. Application Guideline of multifunctional coating additive</b>	<b>157</b>
	<b>Annex II. Repository of technologies</b>	<b>158</b>



# 1.

## FOREWORD



**ROBERTO LOLLINI**  
*(Scientific Coordinator)*

The new wave of environmental sensibility among Europeans and the linked multiple benefits of the retail sector make its renovation rate the highest among the building typologies in the EU. Energy efficiency, sustainability considerations, the need for an environmental certification for new shopping centres are all drivers for renovation, also leading to ensuring a high real-estate market value.

Shopping centres have a meaningful urban and social impact. The related sustainability targets influence not only facility management and operational costs, but also customer experience, fundamental for retailers. Besides their standard functions, shopping centres are places for leisure and thus require to be aesthetically attractive and comfortable, without neglecting high quality engineering systems. In order to counteract the development of e-trade, shopping centres need an excellent architecture to attract clients, and high

indoor environmental quality, ensured by efficient HVAC, refrigeration and lighting systems, while using renewable sources as much as possible.

Being the building type with the highest renovation rate and because of their constant modernisation, shopping centres offer the best opportunities to perform deep energy retrofitting, coordinating different stakeholders thanks to reliable drivers and viable targets.

These guidelines were conceived to be a source of inspiration for facility managers and designers, and a guide from the early stages of renovation, providing technology solutions and effective methodological approaches. The solution-sets and methodologies were developed within the CommONEnergy research activities. The project's strategic vision considers the economic, social and environmental impact of shopping centres. It shapes the meaningful role they can play in the future smart grid, linking buildings to the infrastructures, as a hub able to produce, consume and distribute energy.

These guidelines are also a tribute to the memory of Raphael Bointner, our colleague from TU Wien. He was an enthusiastic contributor, an out-of-the-box thinker, and a fair counterpart in negotiations. The CommONEnergy project and the present guidelines started with the EU building stock analysis he chaired, and continued with the practical tools for energy economics analysis he inspired. Thank you, Raphael!

In the name of the whole CommONEnergy team, I would like to thank all contributors, and wish all readers enlightening insights while going through our shopping centre renovation guidelines.



THESE GUIDELINES WERE  
CONCEIVED TO BE A  
SOURCE OF INSPIRATION  
FOR FACILITY MANAGERS  
AND DESIGNERS

**The project CommONEnergy (2013-2017) focuses on transforming shopping centres into energy efficient and high-indoor-environmental-quality buildings, by developing smart renovation strategies and solutions, supporting their implementation, and assessing their environmental and social impact.**

**CommONEnergy in numbers:**

- **3 demo cases, 8 reference buildings & 23 partners from across Europe**
- **25 technologies developed and installed in 4 years**
- **Up to 75% reduction of energy demand, leading to costs reduction**
- **A target payback time up to 7 years**

*ENJOY!*

# 2.

## EXECUTIVE SUMMARY

Special architectural conditions and needs are common in almost all shopping centres. The main retrofit drivers are: (i) improve the indoor environmental quality and functionality, to enhance the customers experience; (ii) reduce the energy consumption; (iii) optimize the building operation and relative maintenance costs and (iv) improve the overall sustainability level reducing the environmental, social, and economic impact.

Shopping centres vary in their functions, typologies, forms and size, as well as the (shopping) trip purpose. To consider the shopping centre building stock as one segment with its own boundaries and trends, the EU FP7 CommONEnergy project set a shopping centre definition<sup>1</sup>:

*"A shopping centre is a formation of one or more retail buildings comprising units and 'communal' areas, which are planned and managed as a single entity related in its location, size and type of shops to the trade area that it serves."*



---

A SHOPPING CENTRE IS A FORMATION OF ONE OR MORE RETAIL BUILDINGS COMPRISING UNITS AND 'COMMUNAL' AREAS, WHICH ARE PLANNED AND MANAGED AS A SINGLE ENTITY RELATED IN ITS LOCATION, SIZE AND TYPE OF SHOPS TO THE TRADE AREA THAT IT SERVES.

---

The European wholesale and retail sector is the big marketplace of Europe, contributing with around 11% of the EU's GDP<sup>2</sup>. Therefore, sustainability of the retail sector may significantly contribute to reaching the EU long-term environmental and energy goals. Within the retail sector, shopping centres are of particular interest due to: their structural complexity and multi-stakeholders' decisional process, their high energy savings and carbon emissions reduction potential, as well as their importance and influence in shopping tendencies and lifestyle.

A shopping centre is a building, or a complex of buildings, designed and built to contain many interconnected activities in different areas. Next to public spaces, there are areas related to work spaces, with different use and location and according to the shopping centre type. They have different opening hours and entrances than the shopping centre.

Today, in addition to the mere commercial function, a shopping centre responds to several customer needs: it exhibits recreational attractions

and modern amenities, and is more commonly visited for eating-out motives than for buying daily needs. The retail tenant mix and atmosphere have the highest relative importance<sup>3</sup>, together with convenience, refreshments and location.

The majority of European shopping centres are already built, but there is still a huge potential for energy savings due to the practice of regular retrofitting and redesign. This state of constant change<sup>4</sup> offers regular opportunities to improve the technical systems, such as lighting, ventilation, the building envelope and monitoring systems, and more.

Every retrofitting involves a careful analysis of the building peculiarities. The use of building energy simulations can help evaluate the balance between gains and losses, and the energy uses, as well as test design options and solution-sets: i.e. external wall insulation combined with natural ventilation, day-lighting and lighting controls, etc.

<sup>1</sup> Bointner et al. (2014). "Shopping malls features in EU28 + Norway"

<sup>2</sup> [http://ec.europa.eu/commission\\_2010-2014/president/news/archives/2014/03/pdf/services\\_en.pdf](http://ec.europa.eu/commission_2010-2014/president/news/archives/2014/03/pdf/services_en.pdf)

<sup>3</sup> Teller, C. (2008). Shopping Streets versus Shopping Malls - Determinants of Agglomeration Format Attractiveness from the Consumers' Point of View. International Review of Retail, Distribution and Consumer Research. 18 (4), pp. 381-403.

<sup>4</sup> Woods, R., Mellegård, S., Schlanbusch, R.D., Haase, M., Skeie, K.S., De Ferrari, A., Cambronero Vazquez, M.V., Ampenberger, A., Bointner, R. (2015). Shopping mall inefficiencies. [http://www.commonenergyproject.eu/uploads/deliverable/file/2/WP2\\_D2.2\\_20150130\\_P07\\_Shopping\\_malls\\_inefficiencies\\_NotPrintable.pdf](http://www.commonenergyproject.eu/uploads/deliverable/file/2/WP2_D2.2_20150130_P07_Shopping_malls_inefficiencies_NotPrintable.pdf)

A plan adaptation to a new specific layout can also be complicated, due to the masonry walls. When the outer surfaces are mostly made of steel and glass, a major part of the intervention involves the envelope energy efficiency: the glass surfaces produce significant solar gains and thermal losses and therefore entail a high-energy consumption.

The proper design of cooling/heating systems linked to effective control strategies, implemented in the so-called Building Management System (BMS), delivers excellent efficiency results. The inclusion of any adjustable shields/shielding or protections to counteract effects of glare or irradiation or otherwise window opening for natural ventilation can be valuable supports.

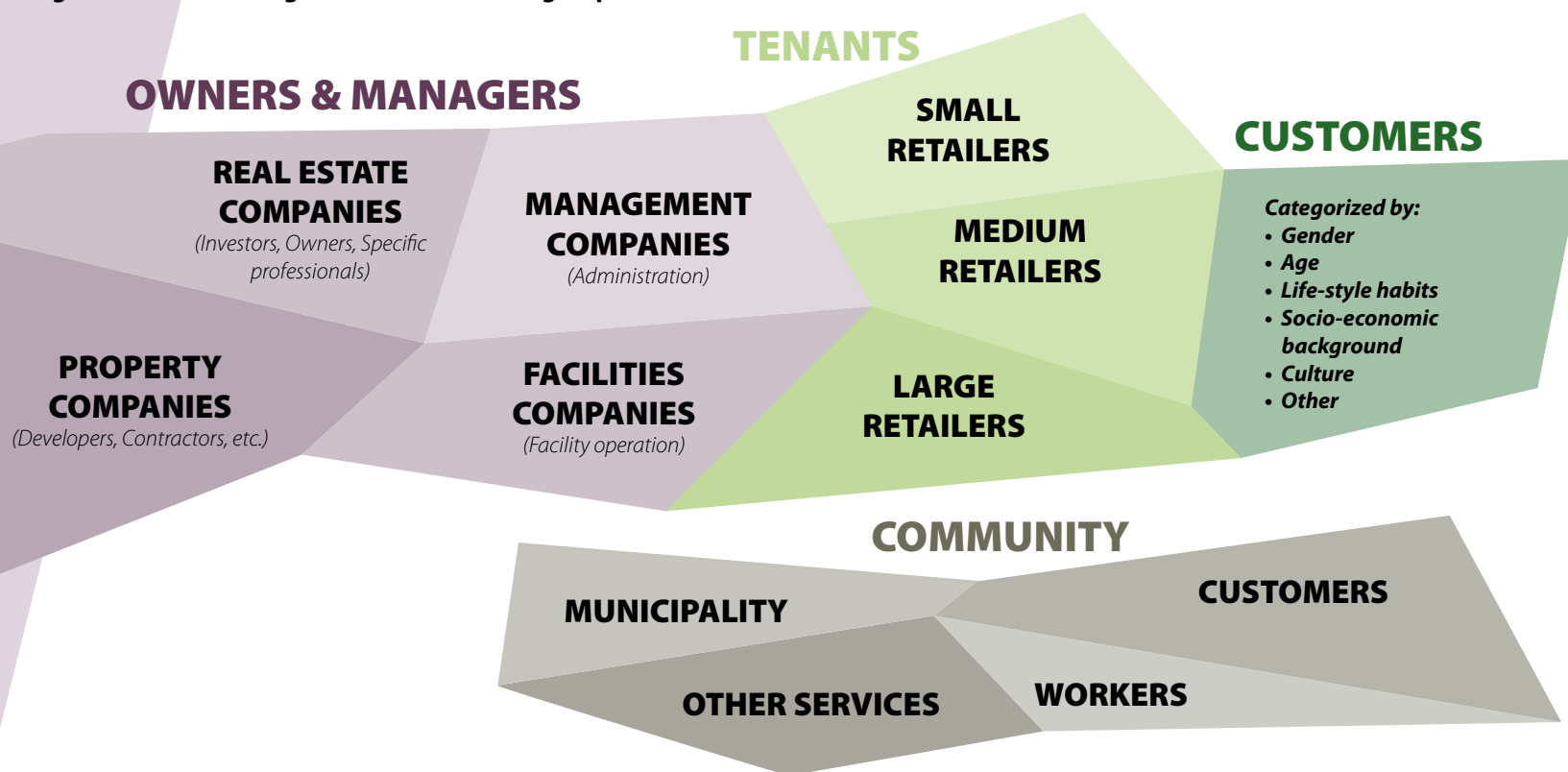
Taking these aspects into consideration, along with the other drivers, has the potential to achieve significant energy reductions and Indoor Environmental Quality (IEQ) improvement<sup>5</sup>.

Three different types of drivers have been identified: direct, indirect, and potential<sup>6</sup>. The direct drivers for energy use reductions in shopping centres should be analysed in collaboration with potential and indirect drivers, which may either support or hinder efforts to achieve the desired energy reductions, depending on the conditions or context provided. The potential and indirect drivers are specific for shopping centres and driven primarily by retail and stakeholder requirements. Their influence provides background for direct drivers and means that actions taken are specific

to shopping centres. However, there is more than one side to direct drivers, and they may not always have a positive effect on energy savings. This, because if the consequences are not correctly understood, they might in some cases function as barriers to energy savings.

Lack of knowledge among stakeholders is a barrier to energy use reductions. Increasing knowledge will potentially function as a driver for implementing actions to achieve energy use reductions. On the other hand, increasing knowledge about energy use in shopping centres on all stakeholder levels is a potential driver for energy efficient upgrades. User awareness and motivation must be seen as a driver for energy use reductions. Costs associated with retrofitting may be seen both as drivers and barriers.

**Figure 2.1 - Introducing the four stakeholder groups**



<sup>5</sup> Stensson, S. (2014). Energy Efficiency in Shopping Malls - Some Aspects Based on a Case Study. Göteborg: Chalmers University of Technology (Doktorsavhandlingar vid Chalmers tekniska högskola. Ny serie, nr: 3762). ISBN: 978-91-7597-081-3.- 178 pp. [Doctoral thesis]

<sup>6</sup> Haase, M., Skeie, K.S., Woods, R., Mellegård, S., Schlanbusch, R.D., Homolka, S., Gantner, J. EU CommONEnergy – Typical functional patterns and socio-cultural context. [http://www.commonenergyproject.eu/uploads/deliverable/file/3/WP2\\_D2.3\\_20150131\\_P07\\_Typical\\_functional\\_patterns\\_and\\_socio\\_cultural\\_context\\_NotPrintable.pdf](http://www.commonenergyproject.eu/uploads/deliverable/file/3/WP2_D2.3_20150131_P07_Typical_functional_patterns_and_socio_cultural_context_NotPrintable.pdf)



## SUSTAINABLE SOLUTIONS REQUIRE THE INCLUSION OF SOCIO-CULTURAL ACTIONS

Sustainable solutions require the inclusion of socio-cultural actions. Owners and managers are interested in reducing energy use, but both customers and tenants have limited knowledge about energy use in shopping centres. Customer needs and interests are at the centre of attention in shopping centres, and as customers seem not so

interested/aware by the topic, there is a danger that other stakeholders will not focus on energy savings.

The number of shopping centres continues to grow and the Gross Leasable Area (GLA) in existing shopping centres is expanding too. Customers will continue to focus on commodities and location if they are not encouraged by those who own and run shopping centres and stores to shop more sustainably. Shopping centres have thus a responsibility to encourage sustainable customer satisfaction.

The EU-funded FP7 project CommONEnergy defined metrics in terms of Key Performance Indicators (KPIs), to determine a project progress in achieving its strategic and operational goals, and tools to handle them. KPIs are a set of quantifiable measures that can be used to gauge the performance over time.

Metrics and tools are used in **Integrated Design Processes (IDP)** to select the best retrofitting actions.

The IDP approach involves: as a first step, the analysis of the current building energy behaviour, the identification of inefficiencies and a proposal of solutions that could be suitable for each building; in a second phase, the assessment analysis of consumption for the living comfort and for other functions, with investment pay-back evaluations.

The retrofitting intervention strategy is hardly configurable with quantity indicators, so it is based on a qualitative level that can identify the applicable potential for each solution item of passive and active efficient proposals. Such indicators assess the quality of the action according to specific standards; they can be divided into four categories:



### ENERGY

*or how the action affects the energy efficiency and energy savings*



### INNOVATION

*compared to current practices in use*



### ACCESSIBILITY

*in the sense of integration possibilities, due to the building codes restrictions, historical characteristics, etc.*



### COSTS

*the economic investment level compared to market costs*

When assessing energy performance, comfort quality and economic feasibility of shopping centres retrofit or new design, a comprehensive approach is needed.

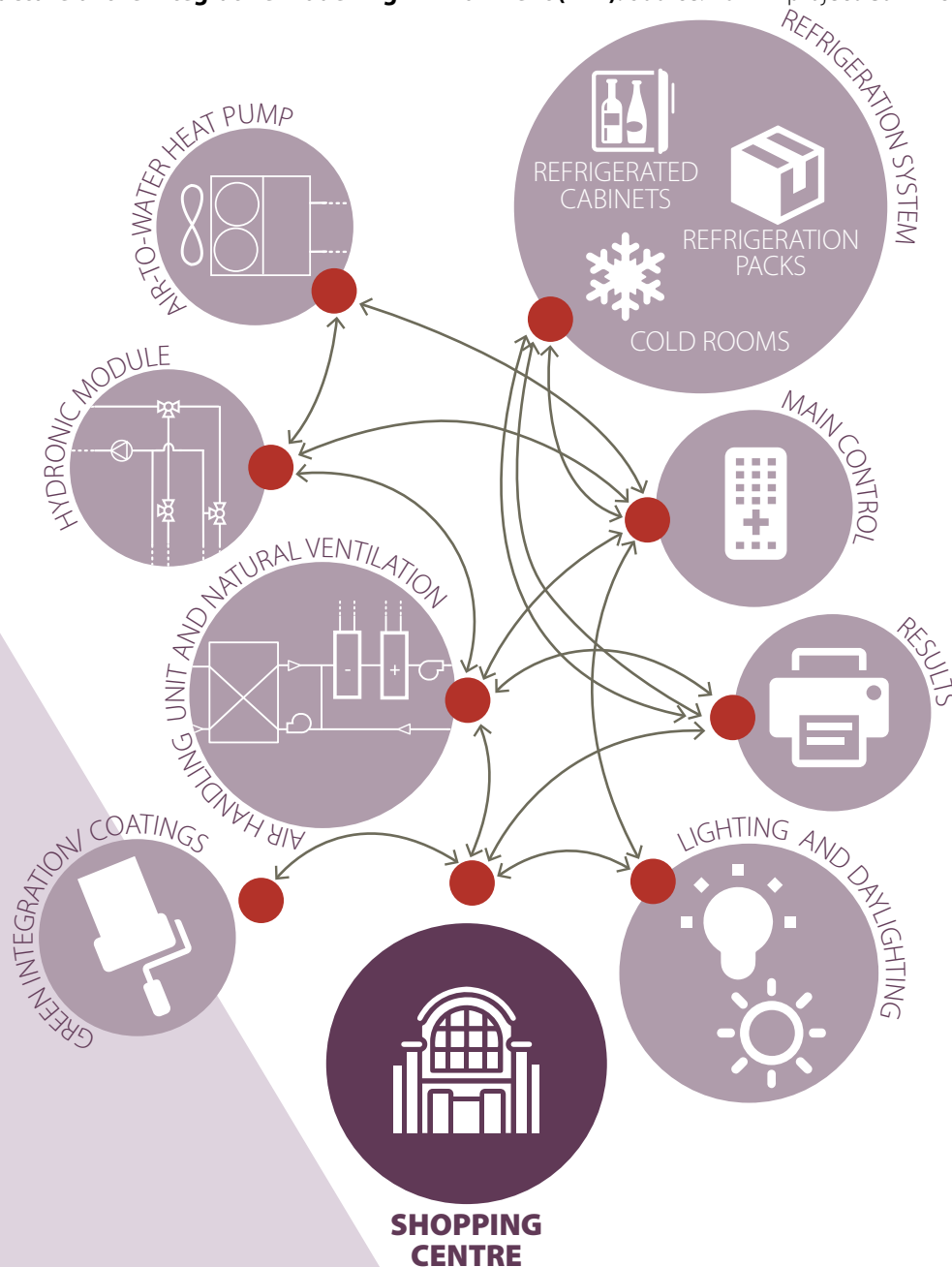
Improvements on the equipment performance or reduction of the building loads, in fact, also influence other parts of the entire shopping centre system. In this sense, during the design process, these interactions cannot be neglected to avoid accounting twice for the same effect or disregarding other phenomena. In complex systems such

as shopping centres, theoretical modelling and dynamic energy simulations can help assess energy efficiency improvement, system functionality and comfort quality of the overall building or of parts of it. With dynamic simulations, in fact, it is possible to account for the different parts that constitute a shopping centre such as the envelope and different use zones, natural and mechanical ventilation, lighting, refrigeration, Heating Ventilation and Air Conditioning (HVAC) systems as well as their interconnections.

Moreover, once the model of the whole system is developed, the control strategies for managing the shopping centre can be implemented and tested. Numerical models and energy dynamic simulations can also have a role during the operational phase. In fact, measured system performance and energy consumption can be used for calibrating the numerical models first and individuating potential malfunctioning and deviation from the expected functioning of the overall shopping centre system afterwards.

CommONEnergy partners developed a structured modelling approach and the so-called **Integrative Modelling Environment (IME)**. The IME enables to easily define a comprehensive numerical model, where the different parts of a shopping centre are available. In the IME, the whole building system is divided into base blocks (see Figure 2.2) that represent the building and its sub-systems (HVAC, refrigeration, lighting, storage systems).

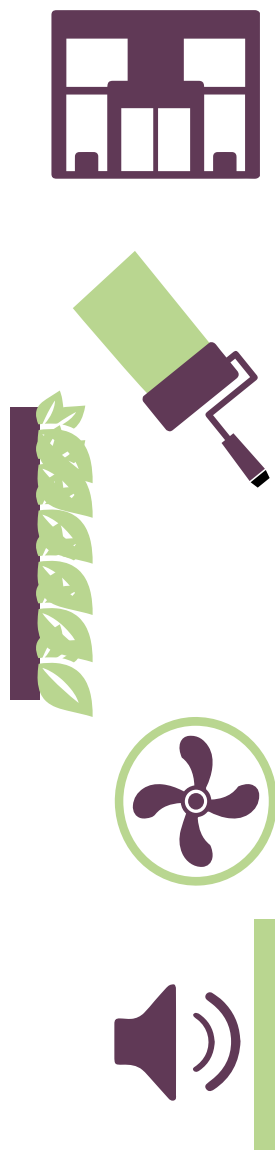
**Figure 2.2 - Modular structure of the Integrative Modelling Environment (IME).** Source: EU FP7 project CommONEnergy.



A parametric definition of the component features and the modular structure of the model layout: eases the development of a shopping centre system model, allows the optimization of the components size and the simulation of different scenarios and solution-sets, facilitates sensitivity analysis, uncertainty analysis, multi-objective optimization and model calibration.

Another design support tool developed in the project is the **Virtual IDP library**<sup>7</sup>, an online repository conceived to provide designers, owners and managers with relevant information to start a shopping centre retrofitting process. The tool collects information about shopping centres' archetypes and specific technology features, as well as climate, social and urban contexts connected to the reduction of energy needs and increase of energy efficiency and comfort in shopping centres.

COMMONENERGY PRODUCED SEVERAL TECHNOLOGY MEASURES ENABLING THE AGGREGATION IN COST-EFFECTIVE SOLUTION-SETS.



- *Façade functions integration*, able to support modularity, flexible to integrate many energy-efficient strategies, adaptable to different climate conditions and indoor environment needs of the building to be retrofitted. The façade system has a structural core that behaves similarly to a curtain wall, but allows flexibility when incorporating strategies or technologies.
- *Multifunctional coating*, based on formulating an additive suitable to be integrated to any aqueous-based paint (for almost every substrate, excluding glass and laminated surfaces). Thus, the final user can pick from a list of properties those suitable for the climate conditions of the application area, and just add the formulation in the desired commercial coating product. The possible characteristics that the final user can choose from are: (i) thermal behaviour enhancement; (ii) Infrared (IR) reflective or IR absorbing; (iii) anti-bacterial / anti-moulding and (iv) self-cleaning / Volatile Organic Compound (VOC) elimination (v) hydrophilicity / hydrophobicity.
- *Greenery integration*, meaning direct use of vegetation to improve the building thermal performance. The vegetation placed on the façade may partly stop the absorption of solar irradiation on the wall surface. In general, greenery can affect the radiative and convective heat transfer characteristics of the façade.
- *Natural ventilation and ventilative cooling*. Ventilative cooling can be defined as “the use of natural or mechanical ventilation strategies to cool indoor spaces. This effective use of outside air reduces the energy consumption of cooling systems while maintaining thermal comfort. The most common technique is the use of increased ventilation airflow rates and night ventilation, but other strategies may be considered as well.” Beyond the consistent energy savings and the power-peak shaving, natural ventilation improves the thermal comfort sensation. Direct interview with customers, combined with field measurement of the environmental parameters, were studied in order to define the most comfortable conditions: a number of at least 80% of people in comfort<sup>8-9</sup> can be reached with an operative temperature<sup>10</sup> of up to 28 °C<sup>11</sup>. This evidence opens room for a cooling set-point refinement that can potentially be modulated depending on outdoor climatic conditions, and highlights possibilities to apply ventilative cooling strategies still guarantying customer expectations and will.
- *Thermal & Acoustic panels for improving acoustic environment*, incorporate two different functionalities: acoustic absorption and thermal insulation. Although there are no specific standards in this subject matter, there is a growing interest to acoustic in shopping centres since the echoing in common areas can create discomfort and unpleasant psychological effects. Sound-absorbing material may have a very wide surface to be effective and for this reason, during the retrofitting of parametric walls, it is financially interesting to select thermal-insulating finishing material, showing at the same time a sound-absorbing property.
- *Lighting systems enabling enhancement of indoor environmental quality and energy savings*. Both criteria can be defined at different levels, starting from passive but very useful measures like increased harvesting of daylight. Room illumination by harvesting daylight should always be the means of choice due to a valuable connection to the natural environment with its ideal light spectrum and a high energy saving potential. Thus, we recommend exploiting daylight more often in shops and shopping centres as currently done. Developed during CommONEnergy, the following are available: (i) modular roof structure; (ii) cylindrical light-tube with highly-reflective material connecting outdoor and indoor environment, (iii) General

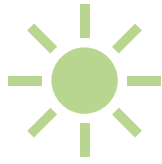
<sup>7</sup> <http://www.commonenergyproject.eu/malls.html>

<sup>8</sup> EN ISO 15251. (2008). Indoor Environmental input parameters for design and assessment of energy performance of buildings addressing indoor air quality, thermal environment, lighting and acoustics.

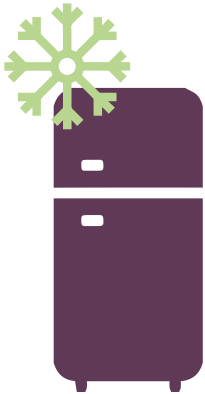
<sup>9</sup> ASHRAE Standard 55. (2013). Thermal Environmental Conditions for Human Occupancy. Atlanta.

<sup>10</sup> The operative temperature represents the temperature experience by the customers which is influenced by both their convective and radiant thermal exchange with the environment (EN ISO 7730, 2005).

<sup>11</sup> Belleri, A. (2017). Ventilative Cooling. [http://www.commonenergyproject.eu/uploads/deliverable/file/8/WP3\\_D3.3\\_20170109\\_P01\\_Ventilative\\_cooling\\_NotPrintable.pdf](http://www.commonenergyproject.eu/uploads/deliverable/file/8/WP3_D3.3_20170109_P01_Ventilative_cooling_NotPrintable.pdf)



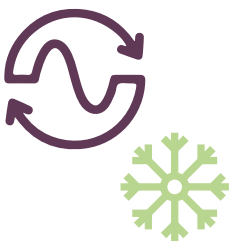
Retail Lighting (GRL), a luminaire for general lighting in the common centre area, (iv) projector/mirror-system for glass-covered multi-stores galleries, (v) wallwasher with high-lumen output for precise illumination of vertical surfaces in shops, (vi) integrated artificial light for light-tubes in shops. A lighting perception study was additionally performed to match luminaire and lighting solutions with an improved customers' experience. Energy savings in lighting can often only be reached with a suitable control. Because of that, we developed the idea of the so-called "Green Lighting Box" which offers a turn-key ready control solution for shops that implements high-quality lighting scenes for retail applications, energy-saving strategies and monitoring possibilities.



- *Optimization of refrigeration cabinets area: technologies and layout.* Energy performance of refrigerated display cabinets must be averaged over time to represent the yearly ecological and economic impact. Off-design conditions account for most of the time due to ambient temperature and humidity that are variable in time and space. Opening rate, food loading, and light dimming can also be very different from one cabinet to the other and influence the real thermal loads. By using modern control equipment, adaptation to store condition can be achieved inside the cabinets with two technologies: (i) water loop and (ii) variable speed fans. Radiant systems, installed on the ceiling or under the floor, are alternative technologies with respect to pure convective HVAC solution for supermarkets. Radiant systems work together with a primary air convective inlet, which ensures the required hygienic ventilation rates. Two reference scenarios, representing common zone layouts in most food stores, were investigated by means of Computational Fluid Dynamics (CFD) technique: (i) Low Temperature (LT) and (ii) Normal Temperature (NT) cabinet zones. The optimization of thermal zoning meets several needs like energy saving, thermal comfort for customers, and avoidance of mist formation on glass doors of closed display cabinets. CFD simulations can be performed to assess the impact of different HVAC configurations on thermal comfort. For what concerns mist formation, the air ventilation system can supply direct fresh air towards the cabinets through different diffusers (square, vortex, and linear). Their impact can be evaluated both in terms of mist removal potential and in terms of thermal comfort impact on the occupied space.

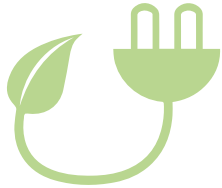


- *Use of Carbon dioxide (CO<sub>2</sub>) heat pump in different climate conditions.* Carbon dioxide operating according to a transcritical cycle is regarded as an energy-efficient option for water heat pumps: the gas cooling process fits well the warming up of a finite stream of water, resulting in a quite large temperature lift in water without significant penalization in COP. Energy savings can be achieved not only making the display cabinets and the Commercial Refrigeration Units (CRU) more efficient but also promoting a synergy with the HVAC system in order to reduce the energy need by means of peak-shaving and energy-recovery procedures. Among the different levels and solutions for integration<sup>12</sup>, those involving CO<sub>2</sub> are the most viable for the replacement of Hydro-Chlorofluorocarbons (HFCs) refrigerants in commercial refrigeration in terms of reduction of the environmental impact. In commercial refrigeration, where two evaporating temperatures are involved i.e. the Low Temperature (LT) to supply the equipment for frozen food and the Medium Temperature (MT) for chilled food, the "booster" configuration with a mid-pressure receiver is considered the baseline to achieve better efficiency in CO<sub>2</sub>-only systems. Due to the extreme variability of operating conditions and shopping centres thermal load requirements, the energy savings for each specific case and climate should be estimated through the dynamic simulation of the integrated systems.



- *Apply demand-response approach for refrigeration.* Demand/Response (D/R) is a program created to motivate end-use customers to reduce their energy usage at critical periods (highest costs or reduced grid reliability). An advanced weather forecasting system can be used to manage refrigeration loads to reduce demand in such critical periods. It is based on the presence of a thermal storage system that can supply the refrigeration during D/R events.

<sup>12</sup> Cortella G., D'Agaro P. (2015). Chapter 10: Integration of air conditioning, refrigeration and energy generation in supermarkets, "Sustainable Retail Refrigeration". Ed. J. A. Evans and A. M. Foster, John Wiley & Sons. Chichester, (UK).



- *Intelligent Building Energy Management System (iBEMS)*. Building Management Systems (BMS) provide effective control algorithms that allow improving building functioning, mainly thanks to the inter-communication of different systems using protocols. An evolution of the BMS are the BEMS (Building Energy Management System) which integrate the energy consumption data in the building management system and correlate the parameters affecting the energy performance. Beyond CommONEnergy, an iBEMS (Intelligent Building Energy Management System) was developed, including the following features: (i) use of open communication protocols for data exchange; (ii) tailorable control algorithms that can manage the interactions among different sub-systems; (iii) advanced graphical environment to effectively transform monitored data in clear and useful information and (iv) reporting tool.
- *Continuous commissioning (CC) platform*, to characterize the operational performance of the building considering comfort, energy and economic aspects. Such performances are compared with the predicted ones in the design phase and with benchmarks. Moreover, the long-term energy and comfort records are used by the energy or facility manager to: fault detection, system optimization, calculate the actual energy saving or to improve comfort.
- *RES integration in the shopping centre*. The electricity grid is transforming from a centralized passive system to a decentralized and active network, characterized by an increasing diffusion of Renewable Energy Generation (RES) and active loads, such as Energy Storage System (ESS) and Electrical Vehicle (EV). The increase of energy prices, combined with the need to reduce CO<sub>2</sub> emissions, encourage the penetration of RES not only at the utility scale but also at the building level. In this context, the shopping centre exhibits favourable characteristics for RES installations. The location of the shopping centres and the weather conditions impact on variable renewable generators such as wind turbine and photovoltaic (PV) systems.



---

TO EASILY SURF AMONG POSSIBLE RETROFITTING SOLUTIONS, WE DEVELOPED THE SHOPPING CENTRE ASSESSMENT TOOL<sup>13</sup> AIMED AT ROUGH ENERGY-ECONOMIC EVALUATIONS OF SHOPPING CENTRES RETROFITTING IN THE VERY EARLY STAGE OF THE DECISION PROCESS.

---

While the method of Life Cycle Working Environment Social Hotspots Database (LCWE-SoHo) can be coupled with standard sustainability assessment and certification, and can be used to assess the whole life-cycle-related social and cultural risks of the shopping centre retrofitting process value chain. It gives insights into the risks related to Labour Laws and Decent Work, Health and Safety, Human Rights and Governance that workers employed within the Life Cycles of the retrofitting measures face.

---

<sup>13</sup> [http://commonenergyproject.eu/eco\\_assessment\\_tool.html](http://commonenergyproject.eu/eco_assessment_tool.html)



# 3.

## INTRODUCTION

Non-residential buildings cover a significant part of the EU building stock, and, among them, the wholesale and retail sector presents the highest specific energy demand, contributing to the widespread perception of shopping centres as being an “icon of the consumerist society”.

Considering their impact on the modern society (particularly at a local level), as well as their urban visibility allowing to reach many stakeholders, the EU-funded RTD project EU FP7 *CommONEnergy* was developed to give practical support to transform them into lighthouses of energy efficient systems and sustainable architecture. With a focus on existing shopping centres to be renovated, and on buildings with a different original function redesigned to become shopping centres, the objective of the project is to enhance their overall sustainability, while changing people’s perception towards them, and enhancing the customers’ experience in terms of indoor environmental quality.

The peculiarities of shopping centres are numerous, directly influencing the retrofitting process: shorter ownership duration, continuous re-styling flux, need of standard pre-manufactured parts, large spaces and volumes, complex layout and

management, peculiar energy end-uses mainly driven by marketing aspects, various involved stakeholders (owner, manager, tenants, customers, community) having different perspectives.

Considering these elements, several solutions-sets for deep systemic retrofitting, as well as support tools and methods for energy-economic evaluation, lean construction and operational management, continuous commissioning, environmental and socio-cultural impact assessment, as well as health and comfort analysis were developed in *CommONEnergy*. The availability of such support tools and methods ensures the widest replication of the investigated and demonstrated cases.

The present guidelines include the most promising *CommONEnergy* achievements, and are thought as a source of inspiration for shopping centre owners and facility managers, as well as for design teams handling the retrofitting process, in particular when it is targeted to energy efficiency enhancement, and improvement of the indoor environment quality. The results can also be useful to other building types, such as hotels, airports and train stations, and much more.

In the case of shopping centres, the set of cost-optimal retrofitting solutions is quite huge, ranging from adaptive envelope to coupling of thermal system (refrigeration, air-conditioning, and hot water), also through suitable heat exchangers to exploit rejected heat.

A comprehensive and interdisciplinary set of needed skills and expertise arises from the variety and complexity of technology solutions and possible performance assessment approaches. E.g. indoor environmental quality in the refrigeration cabinets zone depend on their layout and physical configuration as well as from the ventilation and air conditioning settings.

Energy savings are not the main driver when addressing the building retrofitting, the chase for even better customers experience and marketing analysis being in general the main factors currently feeding the stream of constant transformation..

We identified the main inefficiencies of shopping centres, as far as energy, comfort, operational (maintenance) and logistics are concerned and defined shopping centres’ typical functional patterns, the influence of stakeholders on energy figures and their interaction with the social context.



---

THE PRESENT GUIDELINES INCLUDE THE MOST PROMISING COMMONENERGY ACHIEVEMENTS, AND ARE THOUGHT AS A SOURCE OF INSPIRATION FOR SHOPPING CENTRE OWNERS AND FACILITY MANAGERS, AS WELL AS FOR DESIGN TEAMS HANDLING THE RETROFITTING PROCESS.

The following resulting trends were identified following a specific context analysis:

The physical structure (architecture, building, mechanical and electrical systems) of a shopping centre is in state of constant transformation due to the changing requirements of the retail marketing;

Energy retrofitting must be approached considering the state of constant transformation (with possible exploitable co-benefits);

Two possible opposing evolutions: smaller size and location, moving back towards the city centre vs adding leisure and pleasure functions, then increasing size and complexity;

Green retail and green building value are becoming more widely appealing, mainly connected to organic food and sustainable architecture, potentially attracting new kind of customers;

Awareness and knowledge (needing reliable data to be turned into information) are the first and cheapest actions in retrofitting activities, noticing that a participative retrofitting process is the main way to engage stakeholders, trying to face the energy and comfort challenges.

Based on the shopping centres deep retrofitting drivers, it has been possible to populate an open access **Integrated Design Process (IDP) library** as repository of shopping centres retrofitting solution-sets and specific measures (e.g.):

Modular multifunctional climate-adaptive façade system to be widely customised and replicated in different climatic, urban and management contexts;



Greenery integration in building envelope to modify the heat exchange dynamics;



Multifunctional smart coating materials to pursue different goals with an easy-to-apply product;



Lighting concepts for the shopping centres main areas (atrium and corridor, gallery and shop areas);



Layer with a wall-like surface was coupled to a thermal insulation panel, with a double action of diffraction and absorption of the sound wave to improve the indoor acoustic environment;



Energy generation and distribution with optimised overall architecture (components and layout), control strategies and using natural refrigerants;



Artificial lighting systems conceived and developed for shopping centres; a lighting perception study was additionally performed to match luminaire and lighting solutions development with an improved customers' experience.

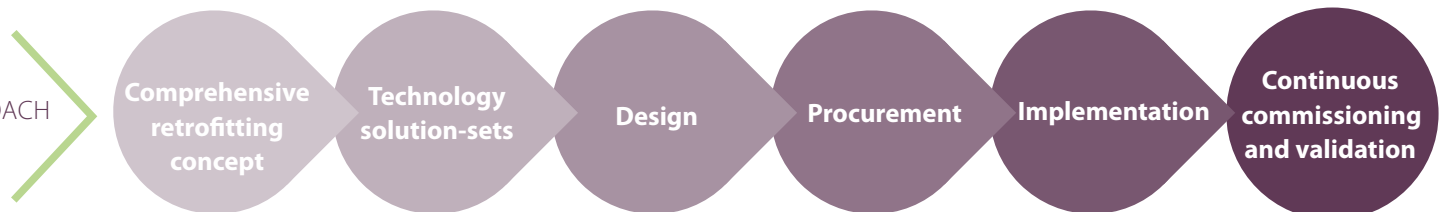


To manage the complexity of the shopping centre retrofitting design phase, it is important to work in an **Integrative Modelling Environment (IME)** including numerical models of all technology solutions used in shopping centres. The IME simplifies the definition of an overall numerical model of the shopping centre to support the design-team decision-process (integrative design process); assessing the building behaviour and systems performance; analysing possible indoor comfort conditions; developing and testing a comprehensive set of control rules and finally defining cost-effective facility-management strategies.

To manage the complexity in the operational phase, a smart building management system is needed, specifically tailored for shopping centres, including functional concepts for infrastructural connection (energy grids, electrical mobility and energy storage systems). Continuous commissioning supports the performance assessment (comfort, energy, economics) in the operational phase, enabling the characterisation of shopping centres in a synthetic way.

Finally, in a retrofitting process, it is important to consider the environmental and social impact to satisfy both the need of developers for a third-party certification of the building quality and the life cycle sustainability of the investment in retrofitting, including benefits for all stakeholders, from owners to community.

COMMONENERGY SYSTEMIC RETROFITTING APPROACH FORESEES THE FOLLOWING STEPS:



These guidelines aim at supporting shopping centres retrofitting process by using integrative modelling environment, optimized technology solutions and methodologies for technical-economic and social analysis, to (i) couple physics in modelling and simulation; (ii) implement combined technology systems to improve energy efficiency and indoor environmental quality and (iii) develop optimal control strategies, continuously adjusted through a commissioning process following the building life cycle.



# 4.

## EU BUILDING STOCK ANALYSIS

It has been a long way from medieval markets, middle-eastern bazars and 18th century arcades to modern shopping centres as we know today. Thus, based on a comprehensive literature review, we provided a definition and categorization criteria of shopping centres in their functional and social context.

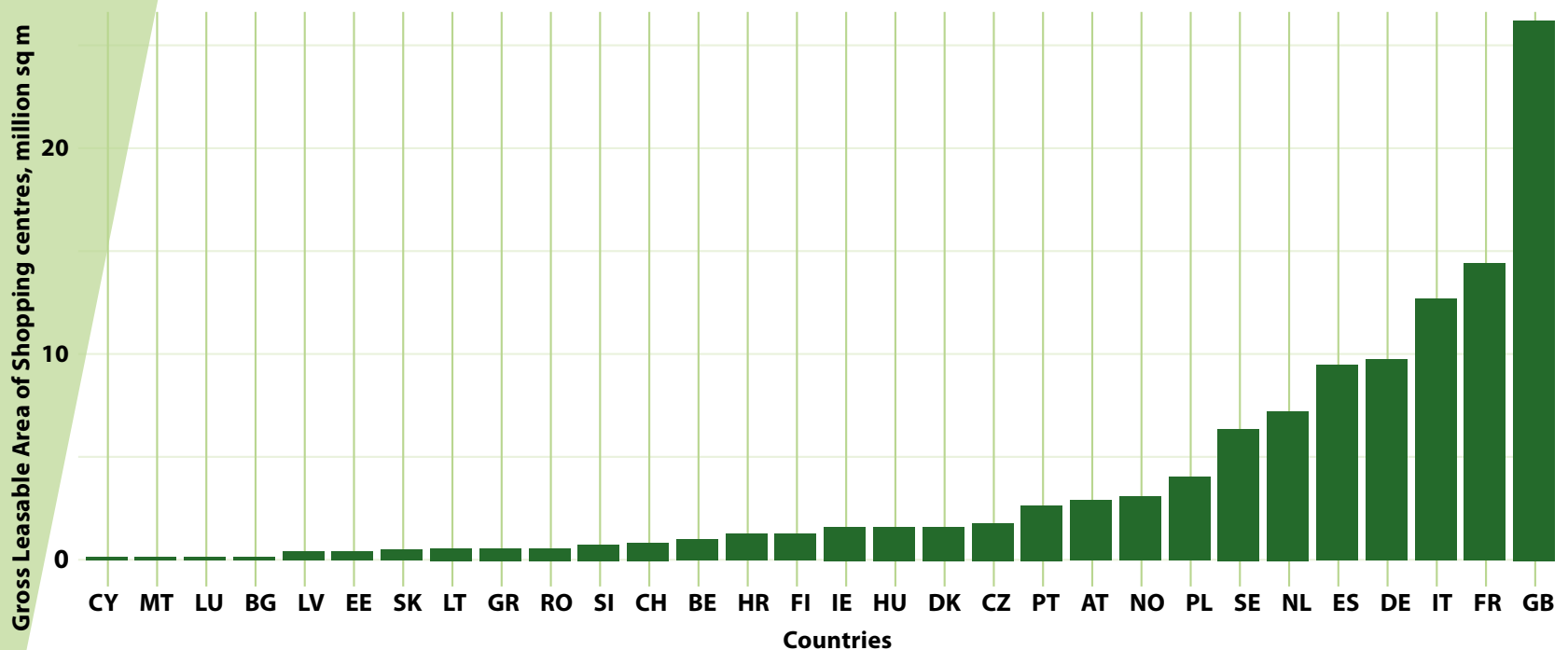
Shopping centres vary, among other criteria, in their functions, typologies, forms and size as well as the (shopping) trip purpose. To be able to consider the shopping centre building stock as one segment with its features and boundaries, a CommonEnergy Shopping centre definition was set<sup>14</sup>:

**“A SHOPPING CENTRE IS A FORMATION OF ONE OR MORE RETAIL BUILDINGS COMPRISING UNITS AND ‘COMMUNAL’ AREAS, WHICH ARE PLANNED AND MANAGED AS A SINGLE ENTITY RELATED IN ITS LOCATION, SIZE AND TYPE OF SHOPS TO THE TRADE AREA THAT IT SERVES”.**

**THE CENTRE HAS:**

- A RETAIL COMPLEX CONTAINING SEVERAL STORES OR UNITS AND
- A MINIMUM GROSS LEASABLE AREA (GLA) OF 5,000 m<sup>2</sup> EXCEPT SOME SPECIFIC TYPES OF SHOPPING CENTRES, E.G. MARKET HALLS

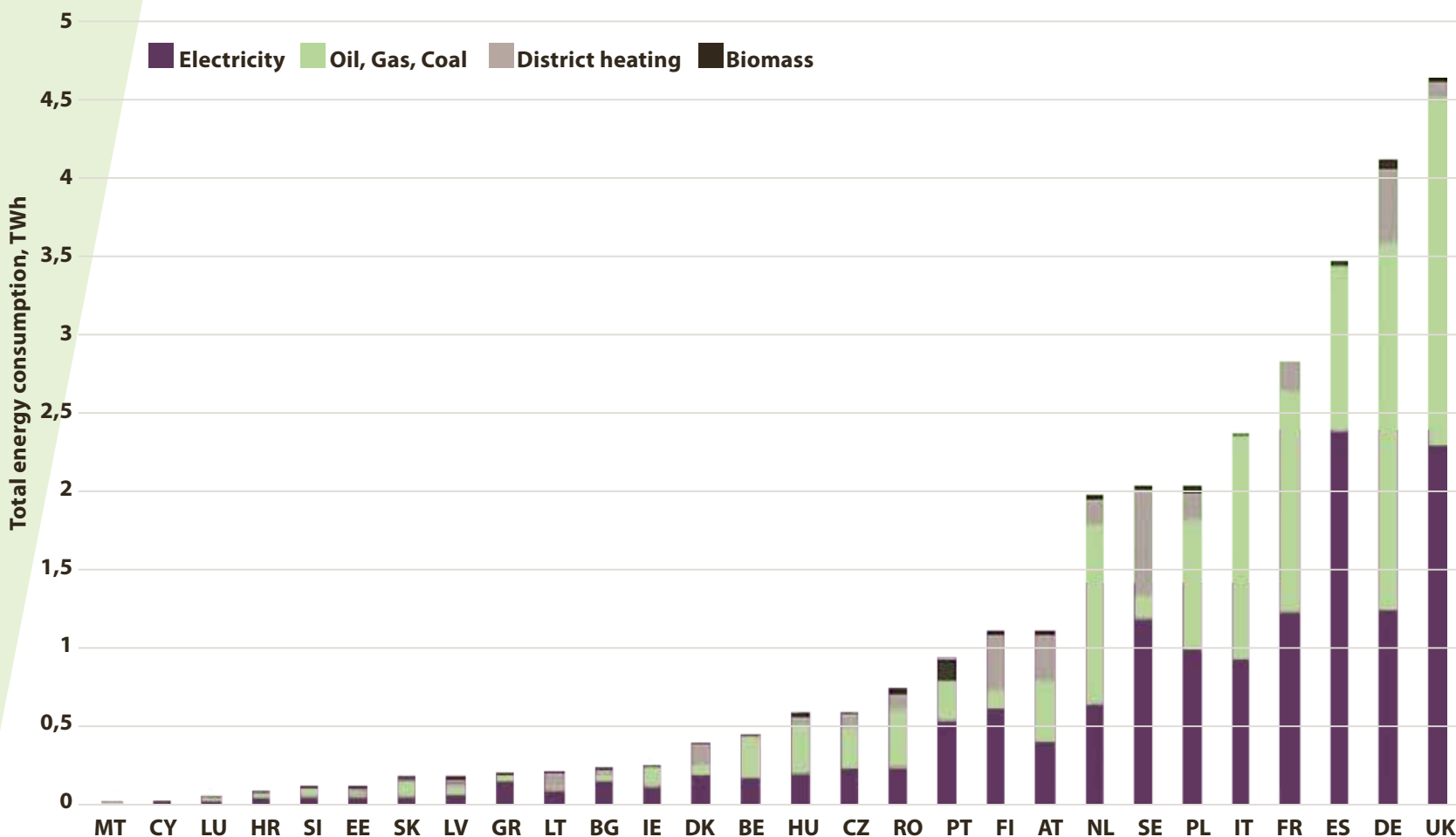
**Figure 4.1 - Gross Leasable Area of Shopping centres larger than 5000 m<sup>2</sup> in the EU-28 and Norway.** Source: Bointner et al., 2014.



<sup>14</sup> Bointner, R., Toleikyte, A., Woods, R., Atanasiu, B., De Ferrari, A., Farinea, C. and Noris, F. (2014). Shopping malls features in EU-28 + Norway. [http://www.commonenergyproject.eu/uploads/deliverable/file/1/WP2\\_D2.1\\_20141130\\_P05\\_Shopping\\_malls\\_features\\_in\\_EU-28\\_and\\_Norway\\_NP.pdf](http://www.commonenergyproject.eu/uploads/deliverable/file/1/WP2_D2.1_20141130_P05_Shopping_malls_features_in_EU-28_and_Norway_NP.pdf)

Quantitative evaluations of shopping centres were complemented by qualitative assessments. Today, there is more than 112 million m<sup>2</sup> shopping centre gross leasable area in EU28, including Norway (of shopping centres larger than 5.000 m<sup>2</sup>). The average GLA per 1000 capita in EU28 + Norway and Switzerland is 224 m<sup>2</sup>, whereas Central and Eastern European countries are below average. These markets are not mature yet, which can also be demonstrated by a relatively young shopping centre building stock in these countries. There, more new construction of shopping centres will occur<sup>15</sup>. The shopping centre building stock in Western Europe is much older and offers opportunities for energy-efficient retrofitting and re-development. The shopping centre retrofitting rate is 4.4 % - very high compared with a retrofitting rate of 1 to 1.5 % in the residential sector<sup>16</sup>.

**Figure 4.2 - Total energy consumption of the EU28 shopping centre building stock subdivided by energy carrier.** Source: Bointner et al., 2014.

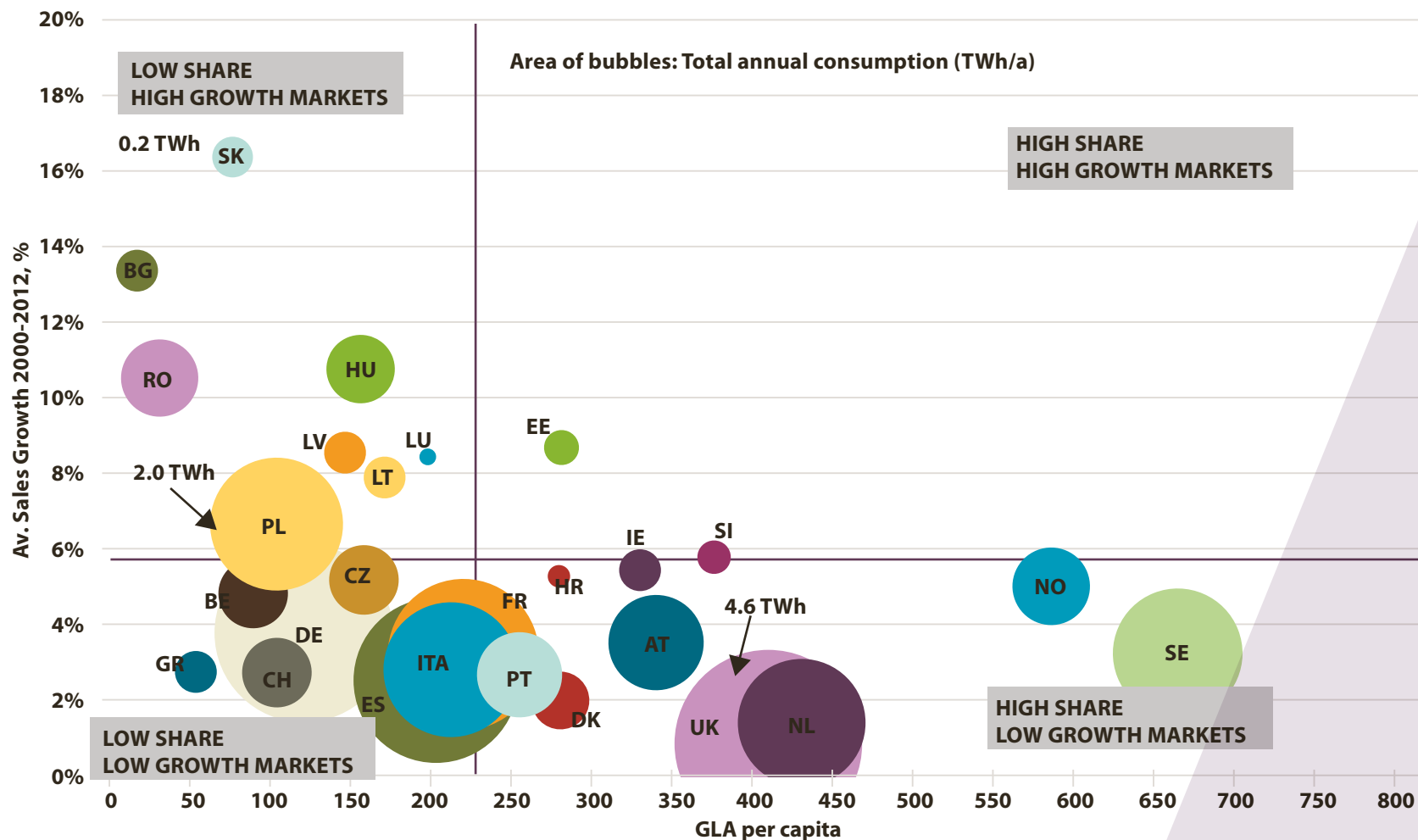


Countries with a large floor area also have a high energy consumption, whereas the specific energy consumption per square meter for the European average is estimated to be 272 kWh/m<sup>2</sup>a. The final energy estimate and the specific energy consumption are based on 119.2 million m<sup>2</sup> shopping centre GLA in EU28 + Norway and Switzerland. Moreover, this sample includes shopping centres smaller than 5.000 m<sup>2</sup>. The predominant energy carriers in the service sector as well as in shopping centres are electricity and natural gas.

<sup>15</sup> ICSC. (2008). The Importance of Shopping Centres to the European Economy. [http://student.icsc.org/srch/rsrch/wp/FINAL\\_Mar08\\_Complete%20WITH%20new%20cover%20and%20charts%20and%20tables.pdf](http://student.icsc.org/srch/rsrch/wp/FINAL_Mar08_Complete%20WITH%20new%20cover%20and%20charts%20and%20tables.pdf)

<sup>16</sup> Bointner, R., Toleikyte, A., Woods, R., Atanasiu, B., De Ferrari, A., Farinea, C. and Noris, F. (2014). Shopping malls features in EU-28 + Norway. [http://www.commonenergyproject.eu/uploads/deliverable/file/1/WP2\\_D2.1\\_20141130\\_P05\\_Shopping\\_malls\\_features\\_in\\_EU-28\\_and\\_Norway\\_NP.pdf](http://www.commonenergyproject.eu/uploads/deliverable/file/1/WP2_D2.1_20141130_P05_Shopping_malls_features_in_EU-28_and_Norway_NP.pdf)

**Figure 4.3 - Average Sales Growth 2000-2012 and GLA per Capita in the EU28, Norway and Switzerland. The area of bubbles indicates the total annual energy consumption, blue lines indicate the mean values.** Source: Bointner et al., 2014.



These data collections and calculations served as basis for selecting **ten reference shopping centres**<sup>17</sup> that were modelled and evaluated within the activities of the project. The selection was done according to six predefined criteria in order to be representative of the European stock for different technology concepts and functions, as well as covering the main climatic zones.

## THE SIX CRITERIA ARE:

CLIMATE  
CONDITION

MARKET  
SATURATION

LOCATION

SHOPPING  
CENTRE  
TYPOLOGY

BUILDING  
TYPOLOGY

OPENING  
YEAR

Following these criteria, shopping centres from seven European countries were selected. The project team was then able to identify inefficiencies and develop systemic solutions that were virtually tested (simulated): 3 of them are the **demo cases** that were retrofitted during the project.

<sup>17</sup> [http://www.commonenergyproject.eu/reference\\_buildings.html](http://www.commonenergyproject.eu/reference_buildings.html)

## 4.1 EU SHOPPING CENTRE BUILDING STOCK SCENARIOS

The European wholesale and retail sector is the big marketplace of Europe, contributing with around 11% of the EU's GDP<sup>18</sup>. Therefore, sustainability of the retail sector may significantly contribute to reach the long-term environmental and energy goals of the EU. Within the retail sector, shopping centres are of particular interest due to their structural complexity and multi-stakeholder decisional process, to their high potential of energy savings and carbon emissions reduction, as well as to their importance and influence in shopping tendencies and lifestyle. In this part of *CommONEnergy*, the current and future energy demand in the European shopping centre building stock was calculated to 2030. A number of policy scenarios on the future total energy demand were derived showing the impact of the most important drivers such as retrofitting rates and implemented energy-efficiency solutions.

### METHODOLOGY

Total final current and future energy demand in the shopping centre's building stock is calculated using a bottom-up approach. The shopping centres are categorized based on the building period, building size and types of shops in the building. For each category, the specific energy demand for space heating and cooling, lighting, ventilation, refrigeration and appliances is calculated. Four different scenarios considering technologic, economic and legal changes between 2015 and 2030 were built.



#### SCENARIO 1

A STATUS QUO SCENARIO INCLUDING MODERATE ENERGY EFFICIENCY MEASURES FOR LIGHTING, APPLIANCES, REFRIGERATION, VENTILATION AND SPACE HEATING



#### SCENARIO 2

INCLUDES POLICIES ADDRESSING MORE AMBITIOUS MEASURES AND CONTROL SYSTEMS FOR LIGHTING, APPLIANCES, REFRIGERATION, VENTILATION AND SPACE HEATING



#### SCENARIO 3

INCLUDES POLICIES ADDRESSING HIGHER ENERGY EFFICIENCY LIKE IN THE 2ND SCENARIO AND ADDITIONALLY THERE IS A RETROFITTING RATE OBLIGATION FOR SPACE HEATING



#### SCENARIO 4

INCLUDES AN EXTERNAL FRAMEWORK CONDITION TAKING NEW SHOPPING CENTRE DEVELOPMENTS INTO ACCOUNT CONSIDERING GROWING MARKET SHARE OF THE INTERNET SALES. THIS LAST SCENARIO IS COMBINED WITH THE 1ST SCENARIO

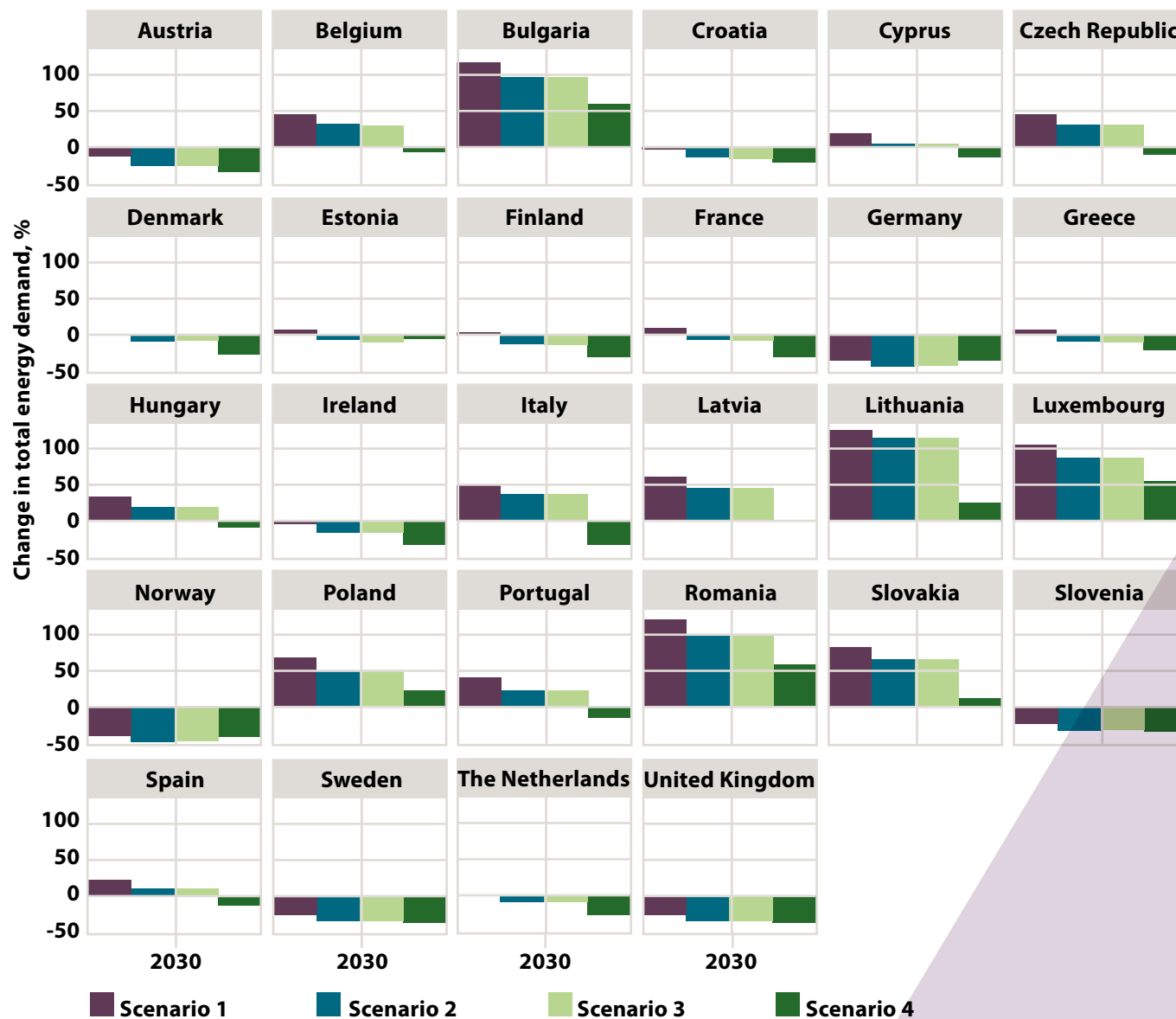
<sup>18</sup> [http://ec.europa.eu/commission\\_2010-2014/president/news/archives/2014/03/pdf/services\\_en.pdf](http://ec.europa.eu/commission_2010-2014/president/news/archives/2014/03/pdf/services_en.pdf)

## RESULTS

Final energy demand for space heating, cooling, appliances, ventilation, refrigeration and lighting was 43 TWh in the shopping centre building stock in 2012. The highest energy demand in the shopping centre buildings is in the United Kingdom followed by Germany and Spain. The share of the energy services on the total energy demand is as follows: lighting (33%), space cooling (25%), appliances (16%), refrigeration (15%), ventilation (6%) and space heating (5%).

The figure 4-4 shows the change in the final energy demand in the shopping centre building stock from 2012 to 2030 in all four scenarios.

**Figure 4.4 - Change in total energy demand for space heating, cooling, appliances, ventilation, refrigeration and lighting from 2012 to 2030 in the European countries in different scenarios.** Source: Toileikyte et.al 2017.





Overall, there is a reduction of energy demand in all scenarios in the saturated markets (i.e. Austria, Ireland, Norway, Sweden and the United Kingdom) and energy demand increase in immature markets (i.e. Bulgaria, Czech Republic, Hungary, Latvia, Lithuania, Poland, Romania and Slovakia) from 2012 to 2030.

## RESULT



### SCENARIO

# 1

The final energy demand increases from 2012 to 2030 in the immature markets. This is due to the increasing number of the new buildings. In saturated markets, total energy demand is decreasing, due to retrofitting of the existing shopping centre buildings and a low rate of new construction due to the market saturation.

## RESULT



### SCENARIO

# 2

Includes more ambitious measures, the energy demand reduction from 2012 to 2030 is higher compared to the previous scenario. The final energy demand from 2012 to 2030 will decrease further in a saturated market, and in immature markets the increase in energy demand is much lower compared to the status quo scenario.

## RESULT



### SCENARIO

# 3

Has an increased thermal-retrofitting rate, slightly greater savings are achieved.

## RESULT

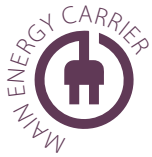


### SCENARIO

# 4

The online market growth reduces shopping centres sales and in turn lowers new construction rates. It is assumed that unsaturated shopping centre markets are less affected by Internet sales than saturated markets. In Bulgaria, Lithuania, Poland and Romania, there is still a growing trend in the future energy demand. However, the increase in energy demand is much lower compared to the previous scenarios.

## DISCUSSIONS



**The energy demand for lighting** makes up the highest share on the total final energy demand. The energy demand for lighting in the total shopping centre building stock in EU28 and Norway can be reduced by up to 62% from 2012 to 2030 with policies for ambitious energy efficiency measures and control systems. Improvements and new innovative technologies (LED, control systems) have a high potential to reduce energy demand in the shopping centres.

**Electricity is the main energy carrier** covering energy demand in the European shopping centres. Thus, reduction of the greenhouse gases is highly dependent on the electricity sector and its decarbonisation.

**In the transition economies** and especially in Bulgaria, Lithuania, Latvia, Poland, Romania and Slovakia there is an **exploitable untapped potential for the new shopping centre development**. The share of new buildings built between 2012 and 2030 on the total building floor area in 2030 is above 50%. Consequently, the total energy demand in the shopping centre building stock is growing until 2030 in these markets. There is a need for new and innovative energy efficiency technologies or new green business models to ensure energy efficiency. Building codes and certification schemes to enhancing green branding could play an important role in encouraging investment in energy efficiency measures for the shopping centres.

**Customer satisfaction** is the essential motivation to renovate the shopping centres. This is the main reason explaining that **the shopping centres building stock is the only sector with high retrofitting rates (average 4.4%/yearly)**. However, this retrofitting rate is often made of renovation measures not related to energy savings. The main stakeholders, the owners, managers and the biggest shops are very much concentrated on two main issues, aesthetic renovation and costs. There is a high potential to realize the energy-saving solutions along the planned aesthetic retrofits and to avoid lock-in effects.

Policy-makers can support and guide shopping centres to reduce their energy demand through clear and stable policies which provide long term drivers to increase energy efficiency. Policies addressing shopping centres must pay attention to the complex physical structure of shopping centres and multiple stakeholders (owners, tenants, customers and administration) involved in decision-making processes. Policies addressing shopping centres should build on existing and efficient voluntary certification schemes.

## REFERENCES

Bointner, R., Toleikyte, A., Woods, R., Atanasiu, B., De Ferrari, A., Farinea, C. and Noris, F. (2014). Shopping malls features in EU-28 + Norway. [http://www.commonenergyproject.eu/uploads/deliverable/file/1/WP2\\_D2.1\\_20141130\\_P05\\_Shopping\\_malls\\_features\\_in\\_EU-28\\_and\\_Norway\\_NP.pdf](http://www.commonenergyproject.eu/uploads/deliverable/file/1/WP2_D2.1_20141130_P05_Shopping_malls_features_in_EU-28_and_Norway_NP.pdf)

ICSC. (2008). The Importance of Shopping Centres to the European Economy. [http://student.icsc.org/srch/rsrch/wp/FINAL\\_Mar08\\_Complete%20WITH%20new%20cover%20and%20charts%20and%20tables.pdf](http://student.icsc.org/srch/rsrch/wp/FINAL_Mar08_Complete%20WITH%20new%20cover%20and%20charts%20and%20tables.pdf)

## FURTHER READINGS

Coleman, P. (2006). Shopping Environments: Evolution, Planning and Design. Elsevier, Oxford, UK.

Cushman & Wakefield. (2014). Marketbeat – Shopping centre development report Europe. April 2014.

Dawson, J. A. (1983). Shopping centre development. Longman. London, UK.

Guy, C. (2003). The Retail Development Process: An Overview. In The Retailing Book: Principles and Applications. P. Freathy, ed. Pearson Education Limited. Harlow, UK.

Toleikyte et al. (2017). Scenarios of energy demand and uptake of retrofitting activities in the EU commercial building sector. [http://www.commonenergyproject.eu/uploads/deliverable/file/29/WP5\\_D5.8\\_20170331\\_P05\\_Replication\\_potential\\_NotPrintable.pdf](http://www.commonenergyproject.eu/uploads/deliverable/file/29/WP5_D5.8_20170331_P05_Replication_potential_NotPrintable.pdf)



VINMONOPOLET

H&M

VINTERSPORT

Dressmann

LINDEX

daschison



City Syd, Trondheim, Norway. Source: CommONEnergy.

# 5.

## ARCHETYPES

A shopping centre is a building, or a complex of buildings, designed and built to contain many activities: shops, neighbourhood services and other discretionary goods stores; restaurants and cafes; common areas and courts for selling activities and events; outdoor parking area or few car park levels. These areas are interconnected with walkways enabling visitors to walk from unit to unit, from entrance and parking lots to common areas and shops. Sometimes, outdoor spaces host resting areas and/or temporary retail units or kiosks for markets and events as well as green / play areas / forecourts.

Besides public spaces, there are areas related to work, with different use and location and according to the type of the centre: staff rooms, restrooms, storage and warehouses, service entrances and unloading services. They have different opening hours and entrances than the shopping centre's.

In addition to the mere commercial function, a shopping centre responds even more to emerging customer needs: it exhibits recreational attractions and modern amenities for shoppers. The retail tenant mix and atmosphere have the highest

relative importance<sup>19</sup> in the survey, also with convenience, refreshments and location.

Every retrofitting involves a careful analysis of the building peculiarities. The analysis of technology features and the functional layout supports the retrofit design: first of all, the basic information about the building, such as general data (location, year of construction, shopping centre typology, climate, area of intervention), building features (design, shape, orientation, parking location), building envelope (structure, material, glazed and opaque surfaces, thermal transmittance), HVAC plants and equipment as well as internal gains (lighting and electric equipment power density).

For example, in case of old and/or masonry building, the retrofitting intervention needs to focus on the building envelope. The use of building energy simulations can help evaluate the balance between gains and losses and the energy uses as well as test design options and solution-sets: i.e. external wall insulation combined with natural ventilation, daylighting and lighting controls etc.

When most outer surfaces are made of steel and glass, a consistent part of the intervention involves the systems efficiency: glass surfaces are subject to significant solar gains and thermal losses, therefore involving a high energy consumption. The proper design of cooling/heating systems linked to an effective control system, called Building Management System (BMS), delivers excellent efficiency results. The inclusion of any adjustable shields/shielding or protections to counteract effects of glare or irradiation or otherwise window opening for natural ventilation can be valuable supports.

A well-planned shopping centre layout generally shows the size and location of each department and shops, any permanent structures, fixture locations and customer traffic patterns<sup>20</sup>.

Each floor plan and functional layout aims at maximizing the sales areas within the shopping centre; usually, in a gallery, the continuous shop fronts are interspersed with plazas and/or clue points. Most of the restaurants/cafes face the central square, hence, making it the heart of the shopping centre.

THE PRINCIPAL  
ELEMENTS OF  
A FUNCTIONAL  
LAYOUT<sup>21</sup> ARE:



SHOPS



COMMON AREAS  
AND ENTRANCES



RESTAURANT,  
CAFETERIA AND  
FOOD COURTS



TECHNICAL ROOMS  
AND WAREHOUSE



PARKING

<sup>19</sup> Teller, C. (2008). Shopping Streets versus Shopping Malls - Determinants of Agglomeration Format Attractiveness from the Consumers' Point of View. *International Review of Retail, Distribution and Consumer Research*, 18 (4), pp. 381-403.

<sup>20</sup> Bellintani S. (2010). I centri commerciali. Progetti architettonici, investimenti e modelli gestionali. ed. Maggioli spa, Italy. Chapter 16.4 'La riqualificazione dei centri commerciali'.

<sup>21</sup> Haase, M., Skeie, K.S., Woods, R., Mellegård, S., Schlanbusch, R.D., Homolka, S., Gantner, J. EU CommONEnergy - Typical functional patterns and socio-cultural context. Table 16. [http://www.commonenergyproject.eu/uploads/deliverable/file/3/WP2\\_D2.3\\_20150131\\_P07\\_Typical\\_functional\\_patterns\\_and\\_socio\\_cultural\\_context\\_NotPrintable.pdf](http://www.commonenergyproject.eu/uploads/deliverable/file/3/WP2_D2.3_20150131_P07_Typical_functional_patterns_and_socio_cultural_context_NotPrintable.pdf)



## SHOPS

Usually each shop has its own system and interior design (except for shop windows and main Heating and Ventilation Air Conditioning (HVAC) system and sales philosophy: for this reason, it is important to raise awareness among tenants and managers about the energy efficiency and environmental impact of their design and management choices.

The large sales areas of anchor stores or big size stores are a significant part of total energy consumption of the shopping centre; especially supermarkets and hypermarkets have a supplementary load due to the food refrigeration system (it absorbs 40-50% of the consumption of total energy demand).



## COMMON AREAS

Common areas of a shopping centre are the walkways and areas in front of each store in a shopping centre and which drive the flow of customer traffic.



## RESTAURANT, CAFETERIA AND FOOD COURTS

Food courts, with restaurants and bars, also have a great influence on energy consumption, since they usually have longer opening hours than shops. The best comfort and a fashion attractive interior design are very important for these areas, to encourage customers to stay longer and extend their shopping experience.



## ENTRANCE

Types and number of entrances (singular or multi) can influence the air conditioning and distribution system and the infiltration control. In addition, the lighting design for atrium space helps to optimize the energy consumption for that area, using a mix of artificial and natural light, mirrors and spotlight to emphasize and point out special zones.

### **Connections**

The number of floors and connections among floors, in addition to defining more specific distribution of the spaces, affects the energy consumption because of the use of electric elevators and escalators. Their energy consumption can be reduced with occupancy sensors.

### **Gallery squares and corridors**

The interior design has to consider higher productivity and efficiency. Besides, some elements of decoration and plants are integral parts of any design<sup>22</sup>. Here follow some recommendations:

- Light levels should appeal to all customers' senses.
- Careful selection of colours can create the desired impressions among customers and employees. Besides, dark colours need more lighting than light colours. Light and tenuous colours, thus also for floor tiles, ceilings, decorations, are preferred both to drive customers' mood and to improve visual comfort.
- Use of fixtures to create smaller spaces, within the hallway or other areas, to create a more intimate atmosphere.

- The customers should be able to move freely in the gallery, without obstructions or risks. If your aisles cause congestion, then customers will feel uncomfortable and unsafe.
- Ceilings and false ceilings allow to use void or different height to place ducts and pipes.

The gallery inner central plaza is the retrofitting's clue point; usually optimal atmosphere is created by mixing artificial and natural light. Daylight is important for the human perception of the daily cycle (the circadian cycle). Moreover, besides the contribution of natural light, we should consider the possibility to use natural ventilation within these spaces, by exploiting the height difference of various spaces to locate windows or skylights, to ventilate and cool the spaces.

<sup>22</sup> Tronconi O. AA.VV (2010). I centri commerciali. Progetti architettonici, investimenti e modelli gestionali. ed. Maggioli spa, Italy. Chapter 1.2 'L'evoluzione delle strutture per il commercio'



## TECHNICAL ROOMS AND WAREHOUSE

Technical rooms host systems and plants that provide heating, cooling, ventilation, electricity, water, safety and control to the whole shopping centre. It is recommended to place them as close as possible to the conditioned areas, to reduce the thermal losses of the distribution system.

Warehouses are usually not conditioned areas. Their positions, related of the main anchor shop or food store, often influence the shape and orientation of the commercial centre building.

There are many **different layout** options within a design floorplan, each of them is driving customer walking paths and highlighting areas in a different way. The floor plan and store layout depend on store design, which usually can be:

- *Grid/straight form*, usually designed when the commercial centre has a rectangular or compact shape, with parallel paths and aisles; the straight floor plan is an excellent formal layout for almost any type of retail store and the most economical.
- *Free form* (Free-flowing; informal; creates a “friendly” environment); designed to offer excellent visibility for customers and invites movement and traffic flow through the centre; it is characterized by organic/curved shapes.
- *Mixed form*, curves and angle of fixtures and walls mixed for a more flexible layout.

To simplify the retrofitting study approach, and in accordance with the Virtual Integrated Design Process (IDP) library (see chapter 7), the **centre design** can be identified in a few models:

Usually, parking lots of a shopping centre can be located at underground level(s) (a); at ground level (b); on the roof (c); on an external area (d); at ground and roof levels (e) and in an external multi-storey car-park (f). The parking location affects the energy performance and the sustainability of the shopping centre, namely:

- Parking lots located underground or on a covered parking (cases a, b, e and f) need lighting, signals and connections with upper floors;

- *Enclosed*, a commercial centre with a gallery and common areas closed, conditioned, with lighting and other big systems;
- *Semi-enclosed* commercial centre, with gallery and common areas covered but not conditioned, lightened and with each shop having their own systems;
- *Open* commercial centre, where paths and common areas are open and connecting each shop.

The **shape** of the building also influences the energy performance:

- A building block, with a *compact shape* (surface area to volume,  $S/V < 1$ ), has less heat losses through external walls, but also through pipes and ducts which are shorter in a compact building compared to an extended one.
- A building “*in continuity / extended*” ( $S/V > 1$ ), on the contrary, needs to limit/decrease the thermal losses due to longer pipes and to greater external wall area.



## PARKING

- In case parking lots are located on the roof (cases c and e), the extensive use of the roof area may limit the use of skylights for daylighting and natural ventilation, as well as for photovoltaic or solar panel installations;
- Parking lots located on an external area increase the “heat island effect”, causing higher outdoor temperatures. From a sustainability perspective, this kind of parking lots cause a higher soil use, compared to the other ones.

The **building orientation** determines the level of exposure to solar radiation during the day and along seasons, affecting both energy performance and indoor environmental quality. The orientation analysis of a shopping centre can drive retrofitting actions: i.e. a North-facing wall needs higher insulation or, conversely, a window facing the North does not need anti-glare or shading devices.

The use of green vegetation in the external parking area and around the shopping centre creates a biologically active area which effectively contributes to the reduction of the “heat island effect” (chapter 9.3).

Sustainable mobility shall also play an important role in a sustainable shopping centre. Parking areas for public transport, bicycle roads and services for electric cars need to be included in the overall layout of the centre<sup>23</sup>.

<sup>23</sup> Rudolph E. Milian. (2008). The retail green agenda. Sustainable practices for retailers and shopping centers. New York, NY, USA. Chapter 15, ‘alternative transportation. Urban heat island’.

## 5.1 BUILDING FEATURES

The architectural structure of the building constitutes the surface of interaction with outdoor environmental conditions: the choice among different technologies, specific materials or different construction techniques affects the performance of the building in terms of energy consumption, internal comfort, and functionality.

### 5.1.1 STRUCTURE

Generally, retail buildings built have a main frame made of precast structural concrete or pre-stressed concrete. Steel structures are generally not used because of low fire resistance; instead of concrete, pillars can be made by steel and coated or specially treated to resist to fire loads. Old retail buildings may have masonry walls.

### 5.1.2 ROOF AND FLOORS

The roof of a retail building is generally continuous, with waterproofing layer and surface protection. Sometimes it has a thermal insulation, preferably made of galvanized metal covered with a mantle of plastic material (usually Polyvinyl Chloride, PVC).

The most common types are the classic industrial shed or laminated wood structures and panels or corrugated steel deck panels' type (metal support base for waterproofing). Thus, we can identify few types: plan roof, pre-fabricated or made of wood; pitched pre-fabricated roof; shed roof.

For plan-covering floors, extruded structures or extruded restressed concrete panels are also used.

Often, the roof area is used to accommodate technical rooms or HVAC plants, as well as photovoltaic system or solar thermal panels.

When the parking is on the roof, it has to be covered by suitable pavers for vehicles.

Roofs can also be paved or designed with walkways and roof gardens (green roof covering).

Interior floors are mostly made by reinforced concrete prefabricated elements: T or double T-shaped beams, or mixed prefabricated structure (reinforced concrete and bricks).

Several aspects need to be analyzed: water tightness; fire resistance; air ventilation and load variations. During retrofitting design, it is important to consider the variations due to any change of use, the increase of over-runs or equipment replacement.

### 5.1.3 ENVELOPE

In the building industry, there is a great variety of infill panels or 'sandwich panels': with skins in aluminium, stainless steel, etc. The panels can be produced with diversified finishes and texture, according to the needs of the designer. They can be used both as structural and decorative panels.

They are usually made of prefabricated panels without thermal insulation, or sandwich panels with polystyrene. Due to their aesthetic appeal and flexibility, ventilated façades are preferred in case of more structured interventions, or buildings with major architectural importance. Typically, external boards are made of grit, clay, aluminium or porcelain.

### 5.1.4 INSULATION, WATERPROOFING AND COATING

Existing retail buildings are usually not properly insulated: external walls are not insulated; floors and roofs use commonly-insulating-covers such as polystyrene, mineral wool and perlite etc; in some cases, cork is added to the foundation.

In case there is an underground parking, the ground floor needs to be insulated to reduce the energy demand of the building.

Waterproofing is important for roof and foundation.

The coatings or counter-walls on the existing façades may have three purposes: to create a better insulation of the walls; to enhance the architectural intervention and to install and hide some plants.

### 5.1.5 WINDOWS/SKYLIGHT

"Lighting is a central issue in retail, and daylighting is having particular importance in the overall appeal and comfort of a retail environment."<sup>24</sup>

The Window-to-Wall Ratio can vary considerably depending on the type and format of the shopping centre.

Usually, because the shops are facing the shopping arcade, daylighting is obtained mainly through skylights or windows in the inner squares or through changes in volumes / interior heights.

Especially in small shopping centres, skylights are made by polycarbonate because of weight / roof loads and costs issues; supermarkets / hypermarkets often have 'spoilors'.

Usually windows and skylights are equipped with motorised openings, some of which are connected to the fire systems.

External shielding (fixed or mobile) or shadowing panels are usually not installed in existing building but they are being introduced in new building design. Their function is two-fold:

- To create a 'wall filter' capable of ensuring transparency and daylighting;
- To reduce the solar gains.

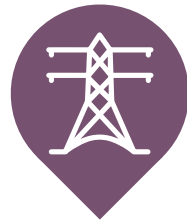
<sup>24</sup> Rudolph E. Milian. (2008). The retail green agenda. Sustainable practices for retailers and shopping centers. New York, NY, USA. Chapter 10 'Can green measures boost sales?'

### 5.1.6 TECHNICAL SYSTEMS

Technical rooms host systems and plants that provide heating, cooling, ventilation, electricity, water, safety and control to the whole shopping centre. It is recommended to place them as close as possible to the conditioned areas, to reduce the thermal losses of the distribution system.

The interaction between the various systems plays an important role in the energy management. First generation shopping centres are not equipped with building management systems able to manage and control the interactions between the various systems.

IN A SHOPPING CENTRE, WE FIND THE FOLLOWING MAJOR SYSTEMS:



ELECTRICAL PLANTS



HVAC SYSTEMS



WATER SYSTEMS



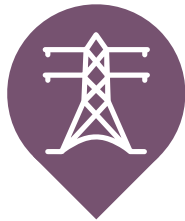
FIRE EXTINGUISHING SYSTEM



FOOD REFRIGERATION SYSTEM



BUILDING ENERGY MANAGEMENT SYSTEM



#### ELECTRICAL PLANTS

Electrical energy consumption is related mostly to:

1. Lighting
2. HVAC system
3. Food refrigeration plants
4. Special plants (security and surveillance system)

Recommended light levels to emphasize the internal structure and visual comfort are typically assured by the combination of natural and artificial lights, direct and indirect. Energy savings can be achieved thanks to a high efficient lamp technology (LED lamps<sup>25</sup>) and an electronic control gear. The electrical consumption of the cooling and heating systems and the other plants is lower than the electricity consumption of lighting. In a supermarket, the food refrigeration system uses the most energy (around 40-50% of a hypermarket energy consumption).

An optimal management of the electricity consumption has to deal with peak-load reduction and shifting through specific function of the BMS and power factor correction.

<sup>25</sup> Light Emitting Diode (LED). "A LED lamp is a light-emitting diode (LED) product which is assembled into a lamp (or light bulb) for use in lighting fixtures. LED lamps have a lifespan and electrical efficiency which are several times greater than incandescent lamps, and are significantly more efficient than most fluorescent lamps" Wikipedia.





## HVAC SYSTEMS

HVAC systems are designed to ensure thermal comfort in every area of the shopping centre.

The most common type of air conditioning system for retail buildings is the gas boiler for heating and a refrigeration system based on air-cooled chillers; an Air Handling Unit (AHU) provides for mechanical ventilation, while fan-coils are installed in the smaller areas of the building such as offices and small shops.

As an alternative, in mild climates, the heating-cooling system can be an air-cooled heat pump.

Big and medium areas can be conditioned by rooftop units and small areas by direct expansion systems (split, multi-split, Variable Refrigerant Volume system (VRV)).

During the retrofitting of the existing plants, three main aspects have to be evaluated:

1. The capacity to satisfy the energy needs;
2. The compliance with the regulations;
3. The cost-effectiveness of its maintenance (age, condition, expected service life, operating costs).

Components which have substantial remaining useful life to allow for steer selection and configuration of new systems can remain, otherwise they need to be replaced or modified.

The average lifetime of a plant can be around 15-20 years; the age of the existing plant and its status must be considered carefully. Old plants are often not equipped with energy efficient devices such as: heat recovery system; inverter on fans and pumps; set up for the exploitation of renewable energy sources and passive solutions (i.e. natural ventilation).

It is important to install a Building Management System (BMS) able to control and manage the interactions between the various components of the HVAC plants.

From an aesthetical point of view, exposed HVAC plants can be visually unappealing if improperly located or specified.



## WATER SYSTEM

In old retail buildings, hot water was produced with electrical or gas boiler. More recent installations are integrated with a solar thermal system.

In a retrofitting plan, water distribution adapts to the needs of the new layout. Typically, the existing pipes are changed or integrated with new ones. If the building is very old or the new layout is very different from the previous one, the water system is completely replaced.



## FIRE EXTINGUISHING SYSTEM

The fire extinguishing system depends on the national and European regulations. In particular, recently, the sprinkler plant regulation is having important developments, as well as its pumping stations, which require sometimes very high performing plants and volumes of water storage, much larger than the one expected in the past. The adaptation to fire regulations has to be planned for each retrofitting; in some cases, it may just be a simple shift of some hydrants or it can include the replacement of the pumping station and of the existing sprinkler system.



### FOOD REFRIGERATION SYSTEM

The food refrigeration system is normally only installed inside supermarkets. It is necessary to analyse if the existing system needs to be expanded (i.e. the number of users served is increased) or if it is simply necessary to retrofit the distribution system.

A typical retrofit requires an increase of the users served and therefore an increase of the required power to the system; this involves the replacement of the generation system. The recent chlorofluorocarbons-Gas legislation and the corresponding global warming potential and ozone depletion effects also requires considering carefully the maintenance of existing facilities; many of the older systems use R404a gas; the newer ones use R134a fluid for refrigerators and fridges while freezers use carbon dioxide gas (CO<sub>2</sub>): these fluids are considered 'environmentally friendly'.



### BUILDING ENERGY MANAGEMENT SYSTEM

A Building Energy Management System (BEMS) is a computer-based control system installed in buildings that controls and monitors the building's mechanical and electrical equipment such as ventilation, lighting, power systems, fire and security systems. A BEMS involves software and hardware.

Building management systems have been around for decades and have been installed to manage the building services' systems. As technology has advanced, these systems have become more complex. With ambitious green legislation targets, rising energy costs and changing user and tenant requirements, it is becoming imperative that all building systems are integrated. This provides the required levels of control and monitoring and provides complete information. The existing BEMS can be updated or integrated with more sensors and functions during a retrofitting.

## REFERENCES

---

Rudolph E. Milian. (2008). The retail green agenda. Sustainable practices for retailers and shopping centers, New York, NY, USA.

Tronconi O., AA.VV. (2010). I centri commerciali. Progetti architettonici, investimenti e modelli gestionali. ed. Maggioli spa, Italy.

Teller C., Shopping streets versus shopping centres. Determinants of agglomeration format attractiveness from the consumers' point of view. The International Review of Retail, Distribution and Consumer Research; article.

## FURTHER READINGS

---

Agenzia Nazionale Efficienza energetica ENEA. (2017). Studio su diagnosi energetiche per la Grande Distribuzione Organizzata. Linee guida per le diagnosi energetiche. Roma, Italy.

Carlo J., Lambert R. (2008). Development of envelope efficiency labels for commercial buildings: Effect of different variables on electricity consumption. Elsevier V.B.

Michaels J. (2016). 2012 Commercial Buildings Energy Consumption Survey. U.S. Energy Information Administration EIA. Washington DC, USA.

Economist Intelligence Unit. (2013). Investing in energy efficiency in Europe's building. A view from the construction and real estate sectors.

World Green Building Council. (2012). A GBC Guide to the EU Energy Efficiency Directive.

Buildings Performance Institute Europe. (2011). Europe's buildings under the microscope. A country-by-country review of the energy performance of buildings.

Consiglio nazionale dei centri Commerciali, CNCC Italy. (2008). L'industria dei centri commerciali in Italia. Milano, Italy.



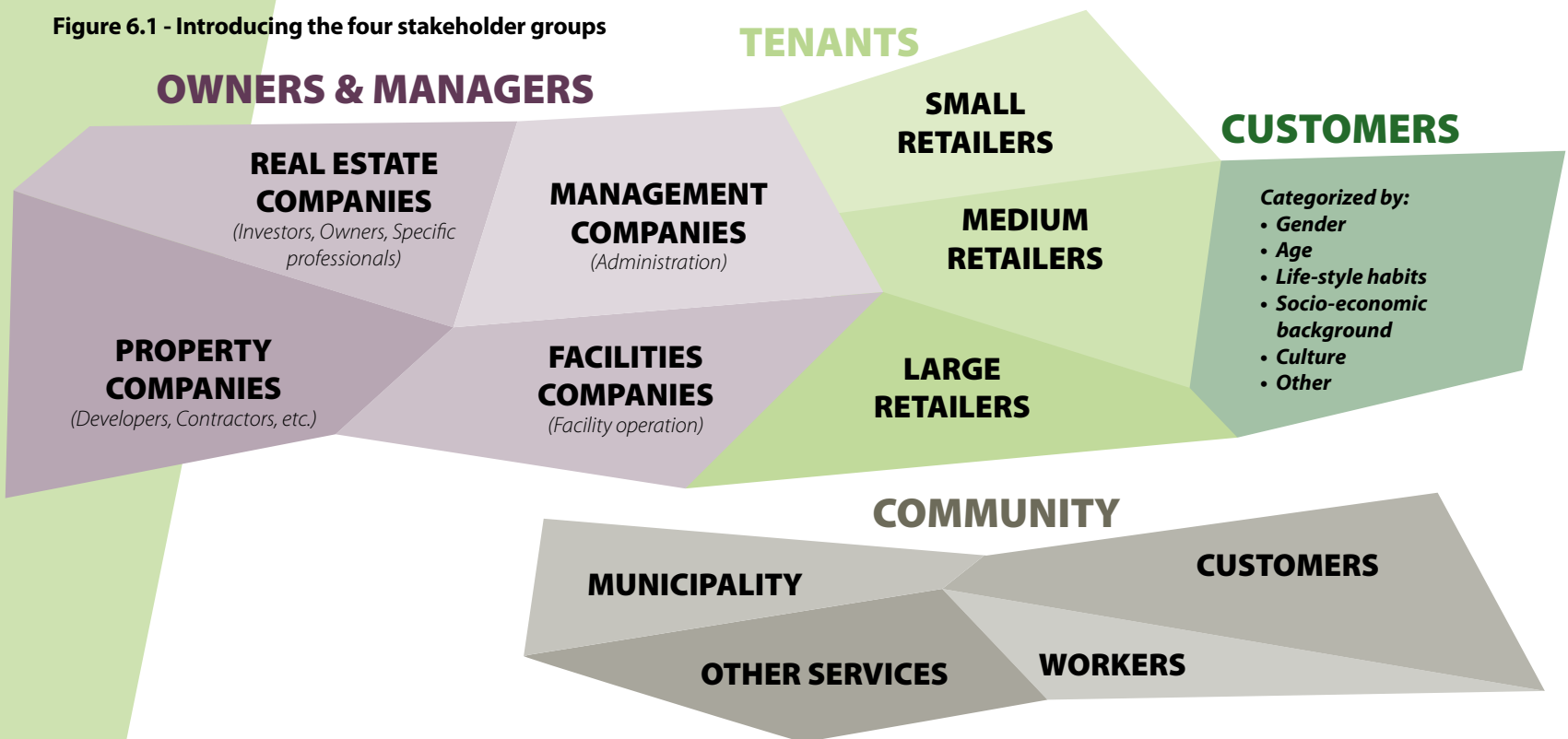
Mercado del Val, some of the team, Valladolid, Spain. Source: Mercado del Val.

# 6.

## STAKEHOLDERS

Based on the analysis of four stakeholder groups and their influence and expectations with regards to drivers, all of the stakeholder groups have different but interconnecting roles in shopping centres. We suggest that the stakeholders may be differentiated in relation to their influence on decision-making practices and by their use of energy in shopping centres.

**Figure 6.1 - Introducing the four stakeholder groups**



The stakeholders influence was individually summarised in four different areas associated with energy use (see also 4.3):

- A description of needs (associated with the retail activity)
- Barriers against energy savings in shopping centres
- Indirect drivers for energy savings in shopping centres
- Direct drivers for energy savings in shopping centres

The main social, technical and economic factors associated with each stakeholder group were condensed under the four areas. The analysis is based on results and discussions initially presented in Woods et al.<sup>26</sup> and Haase et al.<sup>27</sup> and the different aspects are presented in more details in these reports. The needs associated with each stakeholder group may function as barriers, or be understood as drivers, indirect drivers or potential drivers for energy use reductions.

In addition to the effects of drivers, which cause actions aimed at reducing energy use to take place, shopping centres are influenced by constant changes and the regular opportunities to improve the technical systems, such as lighting and ventilation, or the building envelope and management systems. Considering this tendency, along with the drivers, has the potential to achieve significant energy reductions and IEQ improvement. There are, however still some major challenges that are barriers to achieving the desired energy reductions and these are presented below. These are primarily social rather than technical challenges.

Shopping centres aim to provide customer satisfaction, but this cannot, so far, be seen to be an influential factor when considering deep energy retrofitting. Changing shopping habits and user behaviour influences the non-energy-related retrofitting activity and while this may affect the kind of shopping centres built, this kind of user behaviour is not a direct driver for energy use reductions. Changing shopping habits, for example more leisure-based activity, providing for a wider range of leisure activities, eating, meeting, sports facilities and cinemas, all require more space and potentially affect the shopping centre energy use.

Customer behaviour seems to influence the services provided and the kind of shopping centres being built, but it is only an indirect driver for energy savings because customers themselves are not demanding energy savings. This may be a barrier for owners, managers and tenants. They are not pushed by customer demand to take direct actions and as long as their profits remain stable or continue increasing, this will not change. However, consumer awareness is increasing. Increasing knowledge of customers about the implications of their actions in shopping centres may put pressure on the industry to increase their actions aimed at energy savings.

The results of *CommONEnergy's* survey point to tenants knowing little about in-store energy use and having a lack of engagement about energy issues<sup>28</sup>. Owners and managers see a potential for reducing energy use in shopping centres through a collaboration with tenants. This is due to two main factors, firstly tenants are the major energy users in shopping centres, and, secondly, tenants have a high degree of independent control over their in-store energy use. By supplying tenants with knowledge about how lighting, ventilation and building design (all direct drivers for energy savings) affect their in-store energy use (energy bills), owners and managers will encourage tenants to instigate actions to reduce energy use. Without this knowledge, tenants will remain unengaged.



---

## THE RESULTS OF COMMONENERGY'S SURVEY POINT TO TENANTS KNOWING LITTLE ABOUT IN-STORE ENERGY USE AND HAVING A LACK OF ENGAGEMENT ABOUT ENERGY ISSUES.

---

<sup>26</sup> Woods, R., Mellegård, S., Schlanbusch, R.D., Haase, M., Skeie, K.S., De Ferrari, A., Cambronero Vazquez, M.V., Ampenberger, A., Bointner, R. (2015). Shopping mall inefficiencies. [http://www.commonenergyproject.eu/uploads/deliverable/file/2/WP2\\_D2.2\\_20150130\\_P07\\_Shopping\\_malls\\_inefficiencies\\_NotPrintable.pdf](http://www.commonenergyproject.eu/uploads/deliverable/file/2/WP2_D2.2_20150130_P07_Shopping_malls_inefficiencies_NotPrintable.pdf)

<sup>27</sup> Haase, M., Woods, R., Mellegård, S., Skeie, K.S., Lollini, R., Noris, F., Antolín, J. (2015). Main drivers for the deep retrofitting of shopping centres. [http://www.commonenergyproject.eu/uploads/deliverable/file/5/WP2\\_D2.5\\_20150428\\_P07\\_Main\\_drivers\\_for\\_deep\\_retrofitting\\_of\\_shopping\\_malls\\_NotPrintable.pdf](http://www.commonenergyproject.eu/uploads/deliverable/file/5/WP2_D2.5_20150428_P07_Main_drivers_for_deep_retrofitting_of_shopping_malls_NotPrintable.pdf)

<sup>28</sup> Haase, M. (2016). Analysis of the environmental, technical and social drivers and barriers towards regenerative shopping malls, submitted for publication in *Journal of Green Building*.

## 6.1 RETROFITTING DRIVERS

The majority of European shopping centres are already built, but there is still huge potential for energy savings due to the practice of regular rehabilitation and redesign of shopping centres. This state of constant change<sup>29</sup> offers regular opportunities to improve the technical systems, such as lighting and ventilation, or the building envelope and monitoring systems. Consideration of these aspects along with the other drivers has the potential to achieve significant energy reductions and Indoor Environmental Quality (IEQ) improvement<sup>30</sup>. Three different types of drivers have been identified: direct, indirect and potential<sup>31</sup>. The direct drivers for energy use reductions in shopping centres should be seen in collaboration with potential and indirect drivers, which may either support or hinder efforts to achieve the desired energy reductions, depending on the conditions or context provided. The potential and indirect drivers are specific to shopping centres and driven primarily by retail and stakeholder requirements. Their influence provides background for direct drivers and means that actions taken are specific to shopping centres. The three different types of driver, their challenges and effects are as follows:

**Direct drivers** for energy retrofits actually cause a phenomenon, for example a deep energy retrofit, to happen. Their influence is direct and they may be seen as actively influencing energy use reductions in shopping centres today. However, there is more than one side to direct drivers, and they may not always have a positive effect on energy savings. This because, if the consequences are not correctly understood, they may in some cases function as barriers to energy savings. This may clearly be seen, for example, in the cases of knowledge and costs. Examples of direct drivers include:

- The need to reduce energy use in shopping centres is in itself a driver based on the needs to reduce operational costs and overhead costs.
- The improvement of thermal and visual comfort issues could be drivers to improve lighting and thermal aspects related mainly to the envelope, HVAC system and lighting devices.
- The need for systems, which are easier to control and maintain, is a driver, especially regarding the overall management, functional and energy flexibility that could lead to economic benefits, including taking advantage of building-grid interaction aspects.

- Lack of knowledge among stakeholders is a barrier to energy use reductions. Increasing knowledge will potentially function as a driver for implementing actions to achieve energy use reductions. On the other hand, increasing knowledge about energy use in shopping centres at all stakeholder levels is a potential driver for energy efficient upgrades. User awareness and motivation must be seen as a driver for energy use reductions. Increasing user awareness might for example be achieved through the use of building certification systems. It is important that certification systems are measuring improvements and especially account for the changes during a rehabilitation that occur much more frequently in shopping centres than in other building types.
- Costs associated with retrofitting may be seen as both drivers and barriers.

**Indirect drivers** provide support or background for direct drivers. For example, changing shopping habits and user behaviour influence the non-energy-related retrofitting activity. These retrofitting actions may affect energy use in shopping centres and associating them with energy retrofits is an action to be included in an integrated design process.

**Potential drivers** are drivers that are not actually causing an effect at the moment, but, with the correct set of circumstances in place, they have the potential to become direct drivers. It is not always easy to separate indirect drivers and potential drivers from each other, because they could both affect energy actions. The difference between them is that indirect drivers are already in place, and they have an effect on the physical structure in shopping centres, for example user behaviour, but they are not the main reason for actions to reduce energy use. Potential drivers are not at the moment in place, but if they were in place, they could have a great impact on the amount of energy used in shopping centres. An example of a potential driver is tenant knowledge, that can address their potential engagement.

Sustainable solutions require the inclusion of socio-cultural actions. Owners and managers are interested in reducing energy use, but both customers and tenants have limited knowledge about energy use in shopping centres. Customer needs and interests are at the centre of attention in shopping centres, and because customers are not interested, there is a danger that other stakeholders will not focus on energy savings.

<sup>29</sup> Woods, R., Mellegård, S., Schlanbusch, R.D., Haase, M., Skeie, K.S., De Ferrari, A., Cambronero Vazquez, M.V., Ampenberger, A., Bointner, R. (2015). Shopping mall inefficiencies. [http://www.commonenergyproject.eu/uploads/deliverable/file/2/WP2\\_D2.2\\_20150130\\_P07\\_Shopping\\_malls\\_inefficiencies\\_NotPrintable.pdf](http://www.commonenergyproject.eu/uploads/deliverable/file/2/WP2_D2.2_20150130_P07_Shopping_malls_inefficiencies_NotPrintable.pdf)

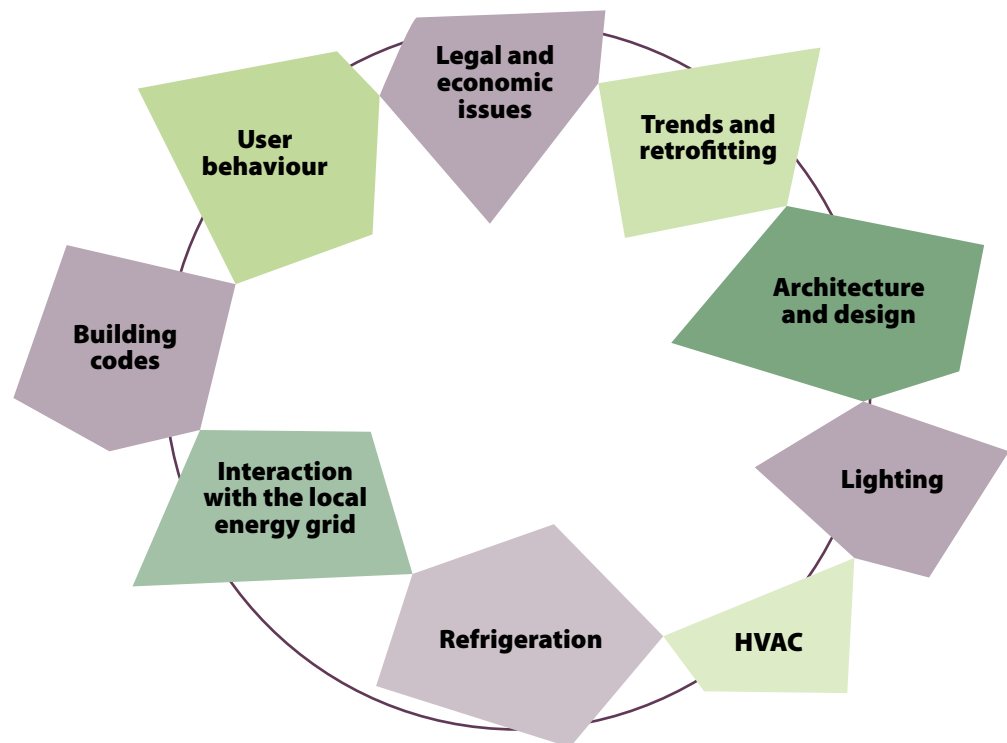
<sup>30</sup> Stensson, S. (2014). Energy Efficiency in Shopping Malls - Some Aspects Based on a Case Study. Göteborg: Chalmers University of Technology (Doktorsavhandlingar vid Chalmers tekniska högskola. Ny serie, nr: 3762). ISBN: 978-91-7597-081-3.- 178 pp. [Doctoral thesis]

<sup>31</sup> Haase, M., Skeie, K.S., Woods, R., Mellegård, S., Schlanbusch, R.D., Homolka, S., Gantner, J., Schneider, S., Lam-Nang, F. (2015). Typical functional patterns and socio-cultural context. [http://www.commonenergyproject.eu/uploads/deliverable/file/3/WP2\\_D2.3\\_20150131\\_P07\\_Typical\\_functional\\_patterns\\_and\\_socio\\_cultural\\_context\\_NotPrintable.pdf](http://www.commonenergyproject.eu/uploads/deliverable/file/3/WP2_D2.3_20150131_P07_Typical_functional_patterns_and_socio_cultural_context_NotPrintable.pdf)

Tenants are responsible for a large part of energy use in shopping centres, and this disinterested energy use implies an acute need to work on changing attitudes and aspirations in the everyday activities in shopping centres.

We cannot expect shopping centres to disappear and take their energy use challenge with them, the number of shopping centres continues to grow and the GLA in existing shopping centres is growing. Customers will continue to focus on commodities and location if they are not encouraged by those who own and run shopping centres and stores to shop more sustainably. Shopping centres have a responsibility to encourage sustainable customer satisfaction. If owners, managers and tenants provide shoppers with sustainable retail environments it may be assumed that shoppers will, to an increasing degree, demand that all shopping centres are sustainable, which will have implications for the design of shopping centres. The retail market needs to change how it presents itself to customers, through for example shopping centre design, and it requires greater focus on customer awareness with regards to energy use.

**Figure 6.2 - Nine drivers and potential drivers**



## **REFERENCES**

Woods, R., Mellegård, S., Schlanbusch, R.D., Haase, M., Skeie, K.S., De Ferrari, A., Cambronero Vazquez, M.V., Ampenberger, A., Bointner, R. (2015). Shopping centre inefficiencies. [http://www.commonenergyproject.eu/uploads/deliverable/file/3/WP2\\_D2.3\\_20150131\\_P07\\_Typical\\_functional\\_patterns\\_and\\_socio\\_cultural\\_context\\_NotPrintable.pdf](http://www.commonenergyproject.eu/uploads/deliverable/file/3/WP2_D2.3_20150131_P07_Typical_functional_patterns_and_socio_cultural_context_NotPrintable.pdf)

Haase, M., Woods, R., Mellegård, S., Skeie, K.S., Lollini, R., Noris, F., Antolín, J. (2015). Main drivers for the deep retrofitting of shopping centres. [http://www.commonenergyproject.eu/uploads/deliverable/file/5/WP2\\_D2.5\\_20150428\\_P07\\_Main\\_drivers\\_for\\_deep\\_retrofitting\\_of\\_shopping\\_malls\\_NotPrintable.pdf](http://www.commonenergyproject.eu/uploads/deliverable/file/5/WP2_D2.5_20150428_P07_Main_drivers_for_deep_retrofitting_of_shopping_malls_NotPrintable.pdf)

Haase, M. (2016). Analysis of the environmental, technical and social drivers and barriers towards regenerative shopping centres, submitted for publication in Journal of Green Building.

Woods, R., Mellegård, S., Schlanbusch, R.D., Haase, M., Skeie, K.S., De Ferrari, A., Cambronero Vazquez, M.V., Ampenberger, A., Bointner, R. (2015). Shopping centre inefficiencies. [http://www.commonenergyproject.eu/uploads/deliverable/file/2/WP2\\_D2.2\\_20150130\\_P07\\_Shopping\\_malls\\_inefficiencies\\_NotPrintable.pdf](http://www.commonenergyproject.eu/uploads/deliverable/file/2/WP2_D2.2_20150130_P07_Shopping_malls_inefficiencies_NotPrintable.pdf)

Stensson, S. (2014). Energy Efficiency in Shopping Centres - Some Aspects Based on a Case Study. Göteborg: Chalmers University of Technology (Doktorsavhandlingar vid Chalmers tekniska högskola. Ny serie, nr: 3762). ISBN: 978-91-7597-081-3.- 178 pp. [Doctoral thesis]

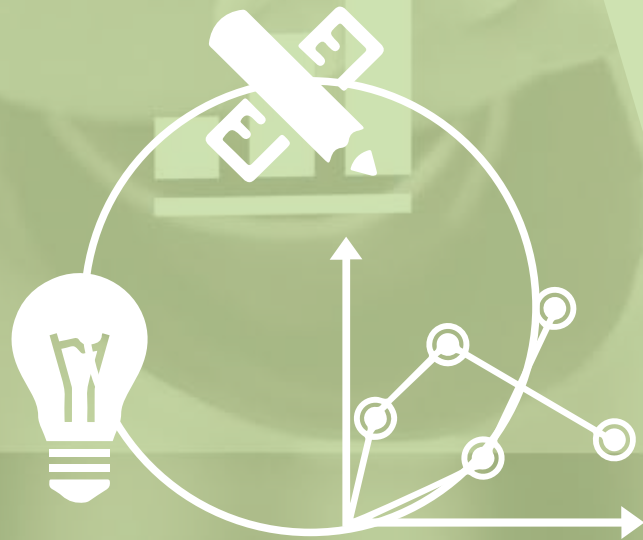
Haase, M., Skeie, K.S., Woods, R., Mellegård, S., Schlanbusch, R.D., Homolka, S., Gantner, J., Schneider, S., Lam-Nang, F. (2015). Typical functional patterns and socio-cultural context. [http://www.commonenergyproject.eu/uploads/deliverable/file/3/WP2\\_D2.3\\_20150131\\_P07\\_Typical\\_functional\\_patterns\\_and\\_socio\\_cultural\\_context\\_NotPrintable.pdf](http://www.commonenergyproject.eu/uploads/deliverable/file/3/WP2_D2.3_20150131_P07_Typical_functional_patterns_and_socio_cultural_context_NotPrintable.pdf)

Larsson, N. and Poel, B. Solar Low Energy Buildings and the Integrated Design Process – An Introduction.



Seller on a market stall, Mercado del Val, Valladolid, Spain





# 7.

## INTEGRATED DESIGN PROCESS (IDP)

The majority of European shopping centres are already built, but there is still a huge potential for energy savings due to the practice of regular retrofitting and redesign of shopping centres. This state of constant change<sup>29</sup>, as mentioned in chapter 6, offers opportunities to improve the technical systems, such as lighting, ventilation and refrigeration systems, or the building envelope. Comprehensive actions on these aspects can be found in the Integrated Design Process (IDP), a multidisciplinary and collaborative process where the work team is composed of different professionals, administrative, retail and marketing experts, shopping owners and investors, buildings professionals and technical experts. They worked together to define, analyse and evaluate different technologies, functional and architectural

solutions and possible interactions<sup>32</sup>. The choices are no longer taken from a single profession, but from a work team through a participatory process; choosing from a wide range of possibilities to identify the best solution, taking into account the quantitative aspects (high energy performance efficiency and high indoor comfort), economic (cost/benefit), functional, aesthetical aspects and energy efficiency parameters to be achieved.<sup>33</sup> IDP for retrofitting of shopping centres is a positive strategy to manage a wide and complex retrofitting process that include more topics, disciplines and qualifications.

In contrast to a linear planning process, an integrated design approach includes feedback mechanisms to evaluate all decisions. The iterative process with

feedback loops not only considers several design steps, but also commissioning and post-occupancy evaluation. The process provides additional flexibility and dynamism, engages all work team members and deliberates more opportunities for cross-communication between team members. During the integrated design process, the use of energy simulations (static and dynamic simulations) can help to calculate and compare a large number of solutions in a very short time and according to the defined performance targets.

Every retrofitting process involves a detailed analysis of the building and its context peculiarities. Some suggested steps to follow in case of a shopping centre retrofitting process are:



### CLIMATE ANALYSIS

for the definition of the local peculiarities for the implementation of passive solutions (natural ventilation, daylighting, ...).



### DEFINITION OF THE KEY PERFORMANCE INDICATORS (KPIs)

for the shopping centres retrofitting. These indicators are used to gauge the shopping centre performance both during the design phases and its working life, to check the operational goals and calibrate the energy flows.



### ENERGY AUDIT

to gather information about the current building status and energy flows help designers detect inefficiencies and energy-saving opportunities.



### MODELLING & DYNAMIC SIMULATIONS

to support the IDP team to define the best solution from energy performance, indoor comfort quality, functionality, economic feasibility, in a wide range of choices.



### COMMISSIONING & POST OCCUPANCY EVALUATION

To assess the functionality and performances of the shopping centre, giving insight on the effectiveness of the building operation.



### VIRTUAL IDP LIBRARY

The library describes the main technology features that characterize the architectural archetype of shopping centres in different contexts and representative of different archetypes.

<sup>32</sup> Larsson, N. and Poel, B. (2003). Solar Low Energy Buildings and the Integrated Design Process – An Introduction [Report]. [s.l.] : IEA-International Energy Agency. <http://www.iea-shc.org/task23/>

<sup>33</sup> Paoletti G. (2013). Integrated energy design in municipal practice. EU IEE AIDA project. IEE/11/832/SI2.615932 [Online]. <http://www.aidaproject.eu/downloads.php>

## 7.1 CLIMATE POTENTIAL ANALYSIS



A climate potential analysis has been integrated during the analysis process of the definition of technologies for different shopping centre cases.

The need to reduce energy use in shopping centres is one of the direct drivers to reduce operational and overhead costs. The idea is based on the improvement of thermal and comfort issues, related mainly to the building envelope, but also to HVAC equipment and lighting devices, influenced mostly by climate, building location, sun exposition as well as its surrounding characteristics, in continuation called *climate potential*.

The climate potential analysis refers to the concept of passive design and helps define the utility of integration of a particular passive technology. The objective of the passive design is to increase the energy performance of the building relying on natural sources such as sun and wind, and to influence positively the decrease of heating and cooling demands. Independently, it might be supported by a building energy management system in some cases.

Passive shaping of indoor comfort in any kind of building is the result of simultaneous impact of many factors. The most important factors are related to location (climate conditions), construction and material properties of the building envelope, building orientation, building geometry and its functions. Basic items of the building energy balance are transient heat and moisture exchange within building envelope assemblies, solar gains, air exchange (ventilation, infiltration) and internal gains (people, light, electric equipment). A climate-driven design involves the

modelling, selection and use of appropriate passive technologies to maintain the thermal comfort at a desired temperature range through the sun's daily and annual cycles. Building Thermal Environment is defined as indoor climate conditions suitable for human activities. In shopping centres and the "tertiary" sector in general, food/other goods damage factors should also be considered. The balance between both comforts may define at the end the effective and final comfort relative humidity and temperature zone. The building environment desired temperature and humidity are usually based on the human thermal comfort, and depend on factors and parameters like temperature, relative humidity, air speed, air quality, human activity.

The objective is to reduce the occurrence of both overheating and overcooling situations. Passive technologies application concerns mainly wall, windows and roof construction. Passive measures might lead to considerable energy savings and consequently operative costs. In general, passive strategies use is based in the major measure on natural energy sources, the same correctly designed should give the positive balance on energy comparing between the costs of retrofitting and costs from energy savings, defined by a pay-back time that should not exceed 7 years.

Most of the passive strategies could be applied in any kind of buildings, including shopping centres. Most common passive technologies are:

- Insulation-innovative material, new coating material with thermal functions (see 9.2.1 )
- Green roofs and spaces (see 9.3)
- Natural Ventilation (see chapter 10)
- Daylight systems and solar tubes (see chapter 13)
- Energy Storage System (see chapter 17)

Their correct application will affect the energy retrofitting success or failure.

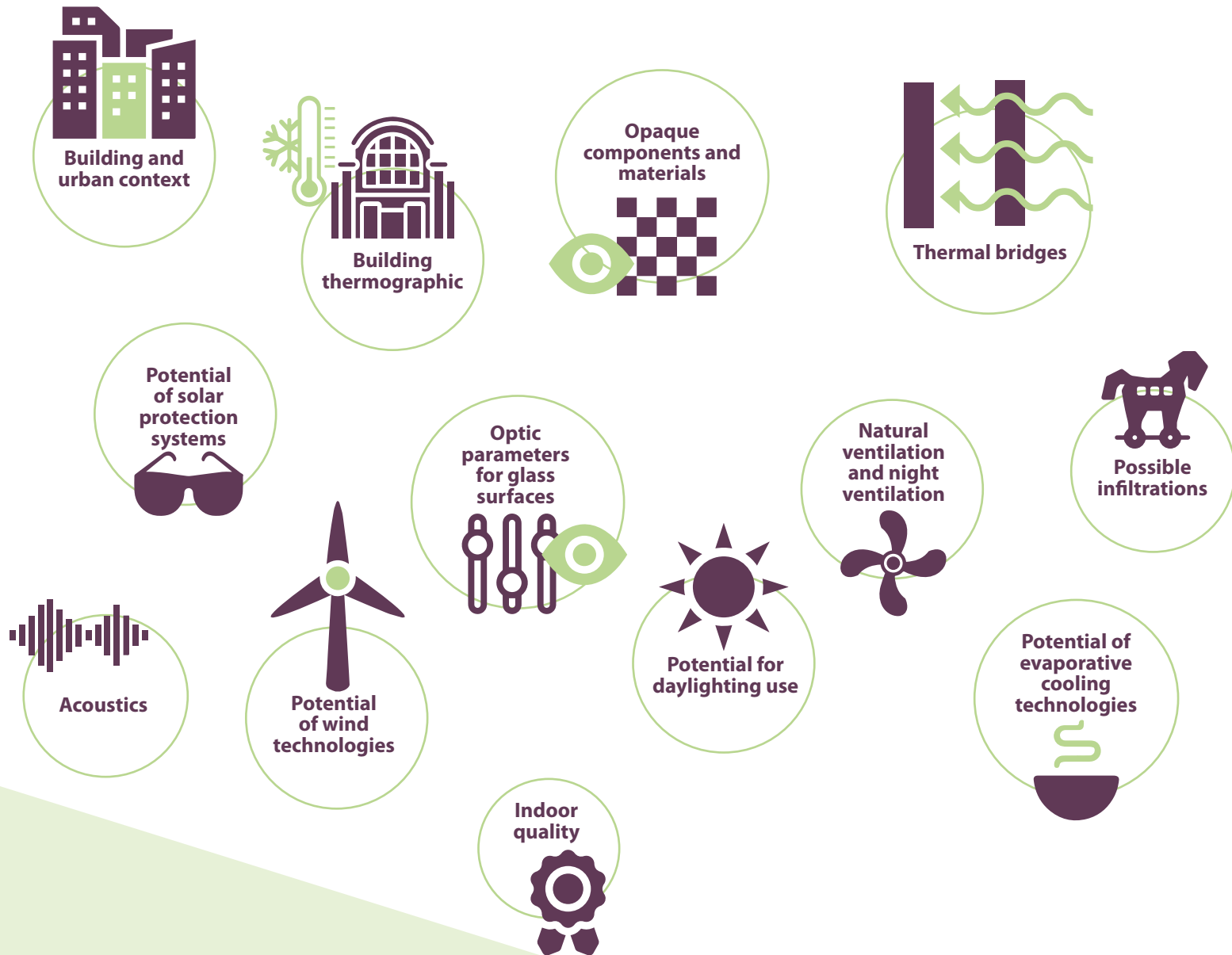


---

THE NEED TO REDUCE ENERGY USE IN SHOPPING CENTRES IS ONE OF THE DIRECT DRIVERS TO REDUCE OPERATIONAL AND OVERHEAD COSTS.

---

IN ORDER TO DEFINE THE MOST CONVENIENT PASSIVE TECHNOLOGIES FOR PARTICULAR CASES,  
THE CLIMATE ANALYSIS SHALL BE SUPPORTED BY OTHER ANALYSES:



There are several tools which help designers define the most appropriate technologies for each case. Incorporating these tools from the project design could steer towards a very efficient, comfortable, and sustainable building.

## 7.2 ASSESSMENT OF RETROFITTING POTENTIAL BY MEANS OF KEY PERFORMANCE INDICATORS



Key Performance Indicators (KPI) are a set of quantifiable measures that can be used to gauge its performance over time. These metrics are used to determine a project progress in achieving

its strategic and operational goals: those raw sets of values, which are fed to systems in charge of summarizing the information, are called *indicators*.

The IDP integrates the concept, generally to select the best actions of a retrofitting for energy efficiency. The design approach involves in the first step the analysis of the current building energy behaviour, the identification of inefficiencies and

a proposal of solutions that could be suitable for each building. The second step is based on an assessment analysis of the energy consumption for the living comfort and for other functions, with investment payback evaluations.

The intervention strategy in a retrofitting is hardly configurable with quantity indicators, so it is based on a *qualitative level* that can identify the applicable potential for each solution item of passive and active efficient proposals.

Qualitative indicators, identifiable and marked as possible candidates for efficiency KPIs for a retrofitting, assess the quality of the action according to certain standards; they can be divided into four categories:

- **Energy**, or how the action affects the energy efficiency and energy savings;
- **Innovation**, compared to current practices in use;
- **Accessibility**, in sense of the integration possibilities, as due to the building codes restrictions, historical characteristics, etc.;
- **Costs**, the economic investment level compared to market costs.

For each indicator, performance levels are expressed with three values: high, medium and low potential, see Table 7.1.

**Table 7.1 - Potential performance levels of some indicators**

POTENTIALS (definition of the positive impact)			LEVEL OF POTENTIAL			
ITEM	DEFINITION/MATERIALS	SPECIFICATION	ENERGY	INNOVATION	ACCESSIBILITY	COSTS
BUILDING	purpose-built		high	high	high	medium
	reconceptualized building		high	high	low	high
YEAR OF BUILD/ BUILD IN	before energy regulations		high	high	low	high?
	after energy regulations		Medium	Medium	medium	high
	new building		low	low	high	low
RESTRUCTURED IN	before energy regulations		high	high	low	high
	after energy regulations		low	low	medium	medium
ORIENTATION	S/ SE/ SW		high	high	high	high
	N/ NE / NW		low	low	high	high
	E/W		medium	medium	high	high
SHAPE	building block		high	medium	high	medium
	in continuity		low	medium	low	medium
POSITION	dense urban		low	low	low	high
	urban		low	medium	medium	medium
	sub urban		medium	medium	medium	medium
	isolated/ independent?		high	medium	medium	medium

<b>CENTRE DESIGN</b>	enclosed	climatized	high	medium	high	medium	
	semi-enclosed	not climatized	high	low	high	low	
	open	not climatized	high	low	high	low	
	multi-level	climatized	high	medium	high	high	
<b>STRUCTURE</b>	masonry		low	medium	medium	high	
	Prefabricated		high	medium	medium	high	
	historical building		medium	high	low	high	
<b>ENVELOPE</b>	structured wall	opaque	medium/high	low	high	low	
		glass	high	medium	medium	high	
	traditional wall	brick	low	low	medium	medium	
		panels	medium	low	medium	low	
	precast panel	panels	medium	low	medium	low	
<b>ROOF</b>	plane	deck	high	medium	high	medium	
		prefabricated	high	medium	high	medium	
		wood	high	medium	medium	medium	
		carriageable	low	medium	low	medium	
		green	low	low	low	high	
	sloped roof/pitched	prefabricated	high	medium	medium	medium	
		shed	high	low	low	medium	
<b>FLOOR</b>	ceiling/false ceiling		high	medium	high	medium	
<b>INTERNAL WALL</b>							
<b>INSULATION</b>	yes		medium				
	no		high				
	material	natural		low	high	medium	medium
		mineral		none	none	none	none
		oil derivatives		medium	low	medium	low
	location: roof	out		medium	low	low	medium
		in		low	low	low	low
		thermal		medium	low	medium	low
		acoustic		none	high	high	high
	location: foundation	out		medium	low	low	high
		in		low	low	low	medium
	location: wall	out		medium	low	low	high
		in		low	low	low	low
		interspace		high	medium	low	high
		thermal		medium	low	medium	low
acoustic			none	high	high	high	
<b>SKYLIGHT</b>	Gallery - %m <sup>2</sup> glass surface/roof area	<10%	low	low	low	low	
		>10%;<30%	medium	low	low	medium	
		over 30%	high	low	low	high	
	Shops - %m <sup>2</sup> glass surface/roof area	<10%	low	low	low	low	
		>10%;<30% over 30%	medium high	low low	low low	medium high	

For a more accurate indication of the effective savings result, in the overall consumption of a shopping centre, each individual saving action/proposal has to be compared to the total consumption. This way, it is necessary to quantify/normalize the reference performance indicators, such as:

- **Energy consumption**, according to utilities (lighting, heating, etc.) that weigh in different ways according to the type of commercial centre;
- **Economic investment**, according to the total cost of investment, still without considering the energy cost savings after retrofitting.

A useful reference/consultation is the report “Systemic solution-sets”<sup>34</sup> where solution-sets for each reference building are described, and which action is weighing the overall intervention: a valuable tool to define the retrofitting strategy.

## 7.3 ENERGY AUDIT



Energy audits are the starting point of an IDP targeting an energy efficient shopping centre. Thus, gathering information about the current building status and energy flows help designers detect inefficiencies and energy-saving opportunities. On the other hand, the energy audit can also be initial input information to start the comparison with similar cases, and to propose the energy efficient solutions potential to be adopted in retrofitting or potential certification process.

The data collected and the benchmarking with similar archetypes allow the auditors to easily identify potential cost-effective measures for improving energy efficiency. The solution-sets

developed for the reference buildings and analysed by building energy simulation are an important source of inspiration for retrofit interventions in similar buildings.

Thanks to a simple structure and ease of use, energy audit templates for information collection can easily be created from the virtual IDP library (see 7.5) and used as a walk-through survey by auditors during their inspection. In fact, the IDP library provides a quick overview of the best solution-sets matching the building features and context.

## 7.4 MODELLING AND DYNAMIC SIMULATIONS



When assessing energy performance, comfort quality and economic feasibility of shopping centres retrofit or new design, a comprehensive approach is needed. Improvements on equipment performance or reduction of building loads, in fact, also influence other parts of the entire shopping centre system. In this sense, during the design process, these interactions cannot be neglected to avoid accounting twice for the same effect or disregarding other phenomena.

In complex systems, theoretical modelling and dynamic energy simulations can help assess energy efficiency improvement, system functionality and comfort quality of the overall building or of some of its parts. With dynamic simulations, in fact, it is possible to account for the different parts that constitute a shopping centre, such as envelope and different use zones, natural and mechanical ventilation, lighting, refrigeration, HVAC systems and their interconnections.

Moreover, once the model of the whole system is developed, the control strategies to manage the whole shopping centre’s systems can be implemented and tested. In shopping centres or in other complex buildings, control strategies are usually developed at single system’s level. A main control able to interact with the different parts of the system can avoid inconsistencies during the operational phase.

Once the retrofit package is individuated and the control strategy is defined, control rules can be tuned, to optimize the internal comfort quality.

Numerical models and energy dynamic simulations can also have a role during the operational phase. In fact, measured system performance and energy consumption can be used for calibrating the numerical models first and individuating potential malfunctioning of the system afterwards.

Depending on the analysis to be performed and on the available input data, appropriate tools must be selected to effectively support the choices during the design process, the definition of the retrofitting solution-sets, the tuning of the control strategies and the assessment of the systems’ performance.

The development of a numerical model able to simulate a complex system, such as a shopping centre, could be significantly time-consuming and a challenging task to handle, producing results with a high degree of uncertainty. A methodology that helps in the modelling of each part of a shopping centre and in the implementation of control rules can be identified in the **Integrative Modelling Environment (IME)**<sup>35</sup>. The IME, in fact, is a modular and parametric structured environment that aims at making the modelling efforts more effective and efficient as well as considering the effects of the interaction between the different sub-systems.

<sup>34</sup> Cambronerio M. V. Antolin J., Haase M., Stenerud Skeie K., Avantaggiato M., Dipasquale C., Belleri A. (2017). Systemic solution-sets. <http://www.commonenergyproject.eu/resources/deliverables>

<sup>35</sup> Dipasquale C. (2016). Integrative Modelling Environment. [http://commonenergyproject.eu/uploads/deliverable/file/15/WP4\\_D4.1\\_20161124\\_P01\\_Integrative\\_Modelling\\_Environment\\_NotPrintable.pdf](http://commonenergyproject.eu/uploads/deliverable/file/15/WP4_D4.1_20161124_P01_Integrative_Modelling_Environment_NotPrintable.pdf)

## 7.5 COMMISSIONING & POST OCCUPANCY EVALUATION



A building monitoring strategy must be part of the shopping centre's retrofit. The data collected by the BMS, which per se is key in the daily operation of the HVAC system, can be converted

in valuable information through the application of a continuous commissioning (CC) platform.

A CC tool eases the analysis of the functionality and performances of the whole shopping centre and its sub-systems, giving insight on the effectiveness of the building operation from energy, indoor environmental quality and economic points of view.

CC strategies can be combined with post occupancy evaluation (POE) campaigns to link the building operation with the impact that it has on the users. POE and continuous commissioning provide all the

needed information to adjust, improve, and fine-tune the overall managing strategy and specific control algorithms. For further details, please refer to chapter 16.

## 7.6 VIRTUAL INTEGRATED DESIGN PROCESS (IDP) LIBRARY



The Virtual IDP library is an online repository conceived to provide designers, owners and managers with relevant information to start a shopping centre retrofitting process.

The tool collects information about shopping centres' archetypes and specific technology features, as well as climate, social and urban contexts connected to the reduction of energy needs and increase of energy efficiency in shopping centres. The identification of each building peculiarities is the starting point for the identification of the most suitable retrofitting solution-set.

The IDP library<sup>36</sup> is publicly and freely distributed on CommONEnergy's website as an online repository to help shopping centres owners and managers in planning retrofitting, providing a quick overview of the best solution-sets matching the building features and context. The IDP library allows easy filtering and user-friendly visualization of the collected information and to add further reference building and solution-sets based on those buildings.

**Figure 7.1 - The IDP library.** Source: EU FP7 CommONEnergy project, <http://commonenergyproject.eu>

The screenshot shows the CommONEnergy website interface for the Integrated Design Process library. The page features a green navigation bar with links for Project, Case Studies, Data and Tools, Resources, Media and events, and Contact. Below the navigation bar is a search section with several dropdown filters: Urban context, Climate, Shopping centre size, Shopping centre sub-typology, and Centre design. A green 'Search' button and a 'Reset' link are located at the bottom of the filter section. To the right of the filters is a text description of the library's purpose and a 'get in touch with the project' link. Below the text is a table listing various shopping centres with their names, locations, and a 'Show' link for each.

Name	Location	Show
Brent Cross	London (UK)	Show
City Syd	Trondheim (NO)	Show
Coop Canaletto	Modena (IT)	Show
Coop Valbisagno	Genova (IT)	Show
Donauzentrum	Wien (AT)	Show
Ex officio Guglielmotti	Genova (IT)	Show
Grand Bazar	Antwerp (BE)	Show
Katane	Catania (IT)	Show
Mercado Del Val	Valladolid (ES)	Show
Parnays	Skute (LT)	Show
Studienas	Klaipeda (LT)	Show
Waasland	Sint-Niklaas (BE)	Show

<sup>36</sup> [http://www.commonenergyproject.eu/integrated\\_library.html](http://www.commonenergyproject.eu/integrated_library.html)



The repository can be populated by different users and could become a reference point for shopping centres' retrofitting solution-sets.

The IDP library layout is structured as follows:

- Description of general, architectural and technological features;
- Baseline simulation-model results;
- Analysis of inefficiencies;
- Retrofit solution-set description;
- Estimated energy and carbon savings, cost analysis of each retrofit solution-set.

The description of general features refers to the selection criteria defined in *CommONEnergy* to identify the 11 reference buildings representative of the EU retail building stock<sup>37</sup>. These criteria include location, type of development, size and Gross Leasable Area (GLA), type of anchor stores and trip purpose.

Architectural features take input from the practical constraints to technology implementation identified by each technology partner. For instance, a parking lot located on the roof might prevent the installation of PV panels, green roof or highly-reflective coatings.

Technological features and building-energy-simulation models support the inefficiencies analysis by describing the building envelope features, the HVAC system efficiencies, the average installed electric-power-density in the tenants and common areas as well as the energy consumption.

The library also collects and enables to select among a pre-defined list of potential inefficiencies at envelope, lighting, HVAC and refrigeration level<sup>38</sup>.

Building energy simulation models are used to identify the more suitable solution-set for a shopping centre retrofitting and to estimate the relative energy savings, to ensure an effective investment, while effectively exploiting, for each case, local natural sources and infrastructures.

Each retrofit solution-set will be evaluated according to the following Key Performance Indicators (KPIs):

- Primary energy savings
- Carbon emission savings
- Comfort level
- Investment cost
- Operational energy cost
- Payback time
- Net Present Value
- Maintenance cost

Starting from the assumption that the reference buildings represent the retail building stock throughout Europe, each library item refers to one of the reference buildings and proposes a retrofit solution-set suited to its peculiarities.



---

THE TOOL COLLECTS INFORMATION ABOUT SHOPPING CENTRES' ARCHETYPES AND SPECIFIC TECHNOLOGY FEATURES, AS WELL AS CLIMATE, SOCIAL AND URBAN CONTEXTS CONNECTED TO THE REDUCTION OF ENERGY NEEDS AND INCREASE OF ENERGY EFFICIENCY IN SHOPPING CENTRES.

---

<sup>37</sup> Bointner, R., Toleikyte, A., Woods, R., Atanasiu, B., De Ferrari, A., Farinea, C. and Noris, F. (2014). Shopping malls features in EU-28 + Norway. [http://www.commonenergyproject.eu/uploads/deliverable/file/1/WP2\\_D2.1\\_20141130\\_P05\\_Shopping\\_malls\\_features\\_in\\_EU-28\\_and\\_Norway\\_NP.pdf](http://www.commonenergyproject.eu/uploads/deliverable/file/1/WP2_D2.1_20141130_P05_Shopping_malls_features_in_EU-28_and_Norway_NP.pdf)

<sup>38</sup> Woods R., Mellgård S., Schlanbusch R. D., Stenerud Skeie K., Haase M. (2015). Shopping malls inefficiencies. *CommONEnergy*. [http://www.commonenergyproject.eu/uploads/deliverable/file/2/WP2\\_D2.2\\_20150130\\_P07\\_Shopping\\_malls\\_inefficiencies\\_NotPrintable.pdf](http://www.commonenergyproject.eu/uploads/deliverable/file/2/WP2_D2.2_20150130_P07_Shopping_malls_inefficiencies_NotPrintable.pdf)

## REFERENCES

---

- Paoletti G. (2013) Integrated energy design in municipal practice. EU IEE AIDA project. IEE/11/832/SI2.615932 [Online]. <http://www.aidaproject.eu/downloads.php>
- Dipasquale C. (2016). Integrative Modelling Environment. [http://commonenergyproject.eu/uploads/deliverable/file/15/WP4\\_D4.1\\_20161124\\_P01\\_Integrative\\_Modelling\\_Environment\\_NotPrintable.pdf](http://commonenergyproject.eu/uploads/deliverable/file/15/WP4_D4.1_20161124_P01_Integrative_Modelling_Environment_NotPrintable.pdf)
- Bointner R., Toileikyte A. (2014). Shopping centres features in EU28 + Norway. [http://www.commonenergyproject.eu/uploads/deliverable/file/1/WP2\\_D2.1\\_20141130\\_P05\\_Shopping\\_centres\\_features\\_in\\_EU28\\_and\\_Norway\\_NP.pdf](http://www.commonenergyproject.eu/uploads/deliverable/file/1/WP2_D2.1_20141130_P05_Shopping_centres_features_in_EU28_and_Norway_NP.pdf)
- Cambroner M.V., Antolin J., Haase M., Stenerud Skeie K., Avantaggiato M., Dipasquale C., Belleri A. (2017). Systemic solution-sets. <http://www.commonenergyproject.eu/resources/deliverables>
- Haase, M. (2016). Analysis of the environmental, technical and social drivers and barriers towards regenerative shopping centre. Submitted for publication in Journal of Green Building.
- Haase, M., Belleri, A. Dipasquale, C., Skeie, K.S. (December 2015). Modelling of a complex building in Norway, proceedings Building Simulation conference (BS2015). Hyderabad, India. 6-10.
- Haase, M., Lolli, N., Skeie, K.S. and Noris, F. (November 2015). Cost Optimal Retrofitting Of Shopping Centres In Europe. Energy Procedia. Volume 78. pp. 2058–2063. Elsevier. doi:10.1016/j.egypro.2015.11.223
- Haase, M., Lolli, N. and Skeie, K.S. (December 2015). Development of A Tool For Retrofitting Investments In Shopping Centres, proceedings Building Simulation conference (BS2015). Hyderabad, India. 6-10.
- Haase, M. and Skeie, K.S. (2015). Development of protocol for sub-metering for simulation models of shopping centres, proceedings of International Conference CISBAT 2015 “Future Buildings and Districts – Sustainability from Nano to Urban Scale”. p. 809-814. Lausanne: LESO-PB, EPFL. doi:10.5075/epfl-cisbat2015-809-814
- Haase, M., Skeie, K.S. and Woods, R. (December 11- 12, 2015). Customer Behaviour and Energy Use in European Shopping Centres, proceedings FARU International Research Conference 2015. Faculty of Architecture, University of Moratuwa. Sri Lanka, “Making built environments responsive”.
- Haase, M., Skeie, K.S., Woods, R., Mellegård, S., Schlanbusch, R.D., Homolka, S., Gantner, J., Schneider, S., Lam-Nang, F. (2015). Typical functional patterns and socio-cultural context. <http://www.commonenergyproject.eu/>
- Haase, M., Woods, R., Mellegård, S., Skeie, K.S., Lollini, R., Noris, F., Antolín, J. (2015). Main drivers for the deep retrofitting of shopping centres. <http://www.commonenergyproject.eu/>
- Haase, M., Woods, R. and Skeie, K.S. (November 2015). The Key Drivers For Energy Retrofitting Of European Shopping Centres. Energy Procedia. Volume 78. pp. 2298–2303. Elsevier. doi:10.1016/j.egypro.2015.11.368
- ICSC. (2008). The Importance of Shopping Centres to the European Economy. [http://student.icsc.org/srch/rsrch/wp/FINAL\\_Mar08\\_Complete%20WITH%20new%20cover%20and%20charts%20and%20tables.pdf](http://student.icsc.org/srch/rsrch/wp/FINAL_Mar08_Complete%20WITH%20new%20cover%20and%20charts%20and%20tables.pdf)
- Stensson, S. (2014). Energy Efficiency in Shopping Centres - Some Aspects Based on a Case Study. Göteborg: Chalmers University of Technology (Doktorsavhandlingar vid Chalmers tekniska högskola. Ny serie, nr: 3762). ISBN: 978-91-7597-081-3.- 178 pp. [Doctoral thesis]
- Woods, R., Mellegård, S., Schlanbusch, R.D., Haase, M., Skeie, K.S., De Ferrari, A., Cambroner Vazquez, M.V., Ampenberger, A., Bointner, R. (2015). Shopping centre inefficiencies <http://www.commonenergyproject.eu/>
- Woods, R., Skeie, K.S. and Haase, M. (2016) The Influence of User Behaviour on Energy Use in European Shopping Centres. Sust. Dev., doi: 10.1002/sd.1638

## FURTHER READINGS

---

- Coleman, P. (2006). Shopping Environments: Evolution, Planning and Design. Elsevier. Oxford, UK.
- Cushman & Wakefield. (April 2014). Marketbeat – Shopping centre development report Europe.
- Dawson, J. A. (1983). Shopping centre development. Longman, London.
- Guy, C. (2003). The Retail Development Process: An Overview. In The Retailing Book: Principles and Applications. P. Freathy, ed. Pearson Education Limited. Harlow, UK.



**CommONEnergy** team members in City Syd technical room, Trondheim, Norway. Source: CommONEnergy.

# 8.

## MODELLING TO ASSESS ENERGY PERFORMANCE AND COMFORT

### 8.1 MODELLING, SIMULATION APPROACH AND TOOLS

When retrofitting a shopping centre, the decision process needs to follow a holistic approach, considering the actual state of the building architecture, its location, climate and needs. In this perspective, a shopping centre optimal re-design shall maximize the benefits in terms of energy savings, systems functionality, indoor environmental quality, sustainability and economic feasibility.

To take successful decisions during a shopping centre energy-retrofit, it is required to use tools helping to evaluate the potential of each energy conservation and energy efficiency measure.

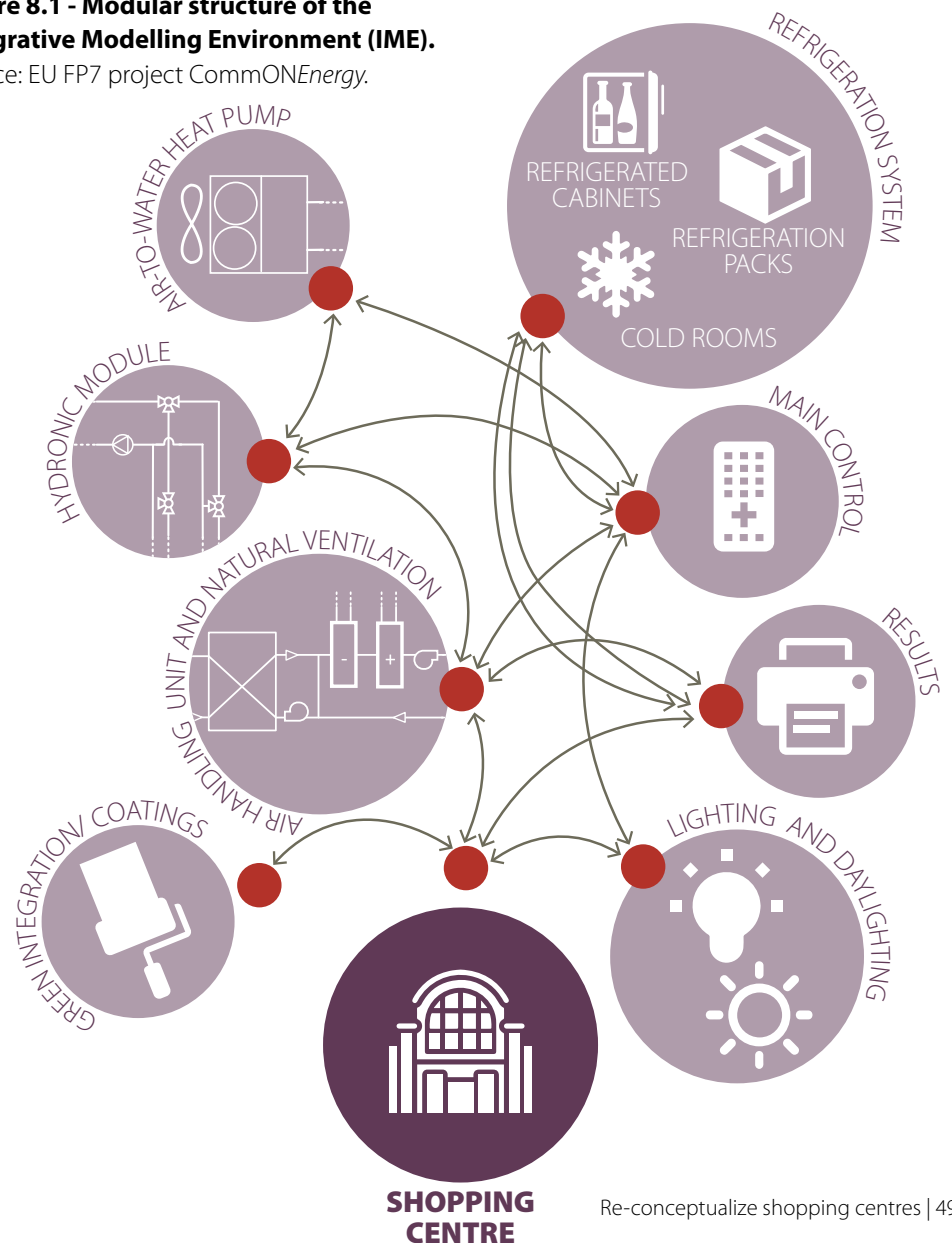
To make the development of a robust building model of complex systems such as shopping centres easier, faster and cost-effective, CommONEnergy partners developed a structured modelling environment called **Integrative Modelling Environment (IME)**.

The IME consists of a simulation environment where the different parts of a whole building energy system are implemented together. In the IME, the whole building system is divided into base blocks (see Figure 8.1) that represent the building and its sub-systems (HVAC, refrigeration, lighting, storage systems).

A parametric definition of the component features and the modular structure of the model layout eases the development of a model for the shopping centre system and the integration in it of different contributions, allows the optimization of the components size and the simulation of different scenarios and solution-sets, facilitates sensitivity analysis, uncertainty analysis, multi-objective optimization and model calibration.

**Figure 8.1 - Modular structure of the Integrative Modelling Environment (IME).**

Source: EU FP7 project CommONEnergy.



## 8.2 INTEGRATIVE MODELLING ENVIRONMENT

The IME includes the envelope and active parts of the entire shopping centre to study the possible impact that each sub-system has on the whole building performance.

Due to the variability of the single cases, the structure of the IME is modular to adapt the specific case to a general layout. Like this, it is possible to implement different scenarios and run parametric analysis to help the decision-maker choose the system configuration to be implemented and the designer on the equipment sizing.

The control system implemented in the IME receives information from each system (refrigeration, HVAC system, lighting, etc.) and gives commands to the equipment (unless general rules must be respected). The IME thus becomes, additionally, a test bench for the control rules before the implementation and during the building operation phase. The system performance can be compared to the assessment and, in case of malfunctioning, the intervention on the specific system is eased. This functionality is useful to the energy manager while operating and maintaining the shopping centre.

The definition of a structured modelling environment with pre-cast components aims at:

- Easing the shopping centre theoretical modelling and simulation;
- Characterizing energy and comfort conditions of shopping centre retrofitting scenarios to support design and facility management teams;
- Optimizing the equipment size and load match;
- Defining an optimal control at the whole building and sub-system levels;
- Supporting the definition of the monitoring layout and equipment;
- Improving the facility management, operation and maintenance.

### 8.2.1 BUILDING ENERGY MODEL

The building modelling phase takes into account the main features of a building such as its geometry, orientation, shadings, construction materials, façade and skylight openings, air changes (infiltration and natural ventilation), schedule, air conditioning systems and settings. The following steps shall be taken into account while modelling the building geometry.

#### 8.2.1.1 Weather file

Weather files represent the climate conditions needed to perform the building energy simulation. Standard weather files derive from historical data series collected by local weather stations and are representative of the average weather conditions of a specific location. Therefore, it is applied to assess the baseline energy consumption and the energy reduction potential of solution-sets. In a model calibration, actual weather files based on a specific period are needed.

#### 8.2.1.2 Thermal zoning

The building should be divided into thermal zones according to space functions, the internal gains level, as well as orientation and floor height. Simplifications are needed to reduce modelling and computing time.

Therefore, building zones should be grouped into thermal zones according to the following criteria:

- **Use:** any room combined into a single thermal zone should have similar internal loads (people, lights, equipment) and use schedules.
- **Thermostat:** any room combined into a single thermal zone should have the same heating and cooling set-points and the same thermostat schedules.
- **Solar gains:** any room combined into a single thermal zone should have similar solar gains. Modellers should consider shading when zoning according to solar exposure. For perimeter zones

with glazing openings, there should be at least one thermal zone for each façade orientation.

- **Perimeter areas:** perimeter areas should be zoned separately from interior spaces, with a depth of perimeter zoning typically within 3 to 5 meters from the exterior wall. This is important as the heating and cooling requirements can vary greatly.
- **Distribution system:** since the entire zone will be assigned to one system type, modellers should only combine rooms served by the same type of HVAC system.
- **Linkages:** linkages represent flow resistances. Combining zones connected through openings involved in the defined airflow path causes an overestimation of the ventilation rates as the flow resistances due to those openings are not considered.
- **Thermal stratification:** in thermal zones with a ceiling height higher than the standard floor height, temperature differences between the bottom and the top of the zone can occur and are potential drivers for stack-driven natural ventilation. To allow ventilative cooling, scenarios modelling thermal stratification should be developed, setting multiple air nodes.

Due to the complexity of shopping centres, the thermal zoning inevitably leads to simplifications to reduce at a minimum the number of thermal zones of the model. Therefore, area with different functions might be aggregated into the same thermal zone. For instance, each shop service room might be part of the same shop thermal zone. However, specific values of internal gains should always refer to the area of the zone referred to the main zone function.

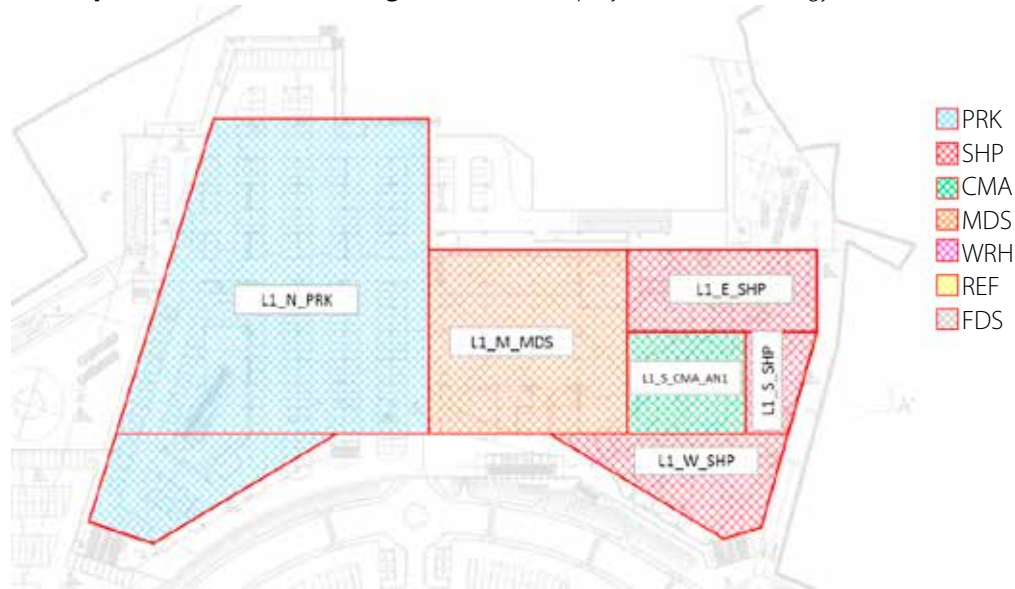
On the other hand, thermal zones must follow an agreed nomenclature<sup>39</sup> which allows identifying easily these zones on a real map. The thermal zones of a shopping centre model can be categorized as follows, depending on their functions:



<sup>39</sup> Dipasquale C. (2016). Integrative Modelling Environment. <http://commonenergyproject.eu/resources/deliverables>

Specific information about which shopping centre area referred to these functions can be found in the report on “systemic solution-sets”<sup>40</sup>. As example, in the following we report the thermal zoning of the Katane’s reference building model, developed within CommONEnergy.

**Figure 8.2 - Katané: first floor plant with thermal zoning.** Source: EU FP7 project CommONEnergy.



**Figure 8.3 - Katané: second floor plant with thermal zoning.** Source: EU FP7 project. CommONEnergy.



As shown in Figure 8.2 and Figure 8.3, the complex building layout is divided into 22 thermal zones, which simplifies a lot the simulation process.

<sup>40</sup> Cambronero M. V. (2017). Systemic solution-sets. <http://commonenergyproject.eu/resources/deliverables>

### 8.2.1.3 Building envelope

Building envelope constructions and thermal properties need to be derived from building plans and energy audit information and input to the building model.

### 8.2.1.4 Boundary conditions

Although we are dealing with existing shopping centres, during a feasibility study, information on HVAC settings and management is not always available. Therefore, we defined standardized input assumptions that could be useful in feasibility studies.

- **Heating and cooling** set points depend on building management. According to common settings, indoor temperatures in retail buildings range between 20 °C (heating set-point) and 25° C (cooling set-point).
- **Lighting** is generally fully on (100%) during the shopping centre opening time. When closing, the lighting power density could be set at 5%. The lighting power density is generally up to 40W/m<sup>2</sup>. Each tenant has its own lighting design and operation schedules related to the shopping centre opening time.
- **Appliances:** devices such as personal computers (PCs), cash registers, monitors, etc., are generally on (100%) in opening hours. In closing hours, appliances' power density could be set at 15%, to take into account standby consumption. Higher power densities shall be considered in case of electronic shops.
- **Infiltration** is the unintentional or accidental introduction of outside air into the shopping centre; typically through cracks in the building envelope and through entrance doors in common areas. Infiltration is significant in shopping centres due to the frequent door opening and closing, but no recent study exists on its estimation. Infiltration and ventilation air changes should refer to the net air volume of the zones.
- **Ventilation** rates are generally set at the minimum required to maintain acceptable indoor air quality. For shopping centres and specifically for conditioned areas, a suitable value could be above 7.35 kg/hr•m<sup>2</sup> which is the minimum required by the standard EN15251:2007 <sup>41</sup>.
- **Refrigeration cabinets** are modelled as negative internal gains to take into account the heat extraction rate. Some reference values for refrigeration cabinets' heat extraction rate and electric power depending on the refrigeration cabinet type and length are reported in Table 8.1. The value should be multiplied by the number of refrigeration cabinets estimated in the food store area.
- **Refrigeration rooms** are located in the food storage and processing zone and are modelled with a simplified heat-transfer equation:

$$Q = \lambda / d \cdot S \cdot (T_{ref} - T_{FDP})$$

where

**Q** = heat extraction rate from the food department zone (FDP) by the refrigeration room [W]

**λ** = thermal conductivity of the refrigeration room walls [W/mK]

**d** = refrigeration room walls thickness [m]

**S** = refrigeration room walls surface [m<sup>2</sup>]

**T<sub>ref</sub>** = indoor-controlled temperature of the refrigerated room (please refer to Table 8.2)

**T<sub>FDP</sub>** = indoor temperature of the zone where the refrigerated room is located

The thermal conductivity of the refrigeration room walls can be assumed as 0.023 W/mK. The wall thickness can be considered as 0.06 m for refrigerated rooms with a positive temperature, and 0.10 m for refrigerated rooms with a negative temperature.

<sup>41</sup> EN15251:2007. Indoor environmental input parameters for design and assessment of energy performance of buildings addressing indoor air quality, thermal environment, lighting and acoustics.



**Table 8.1 - Refrigeration cabinets heat extraction rate and electric power.** Source: EPTA, UNIUD.

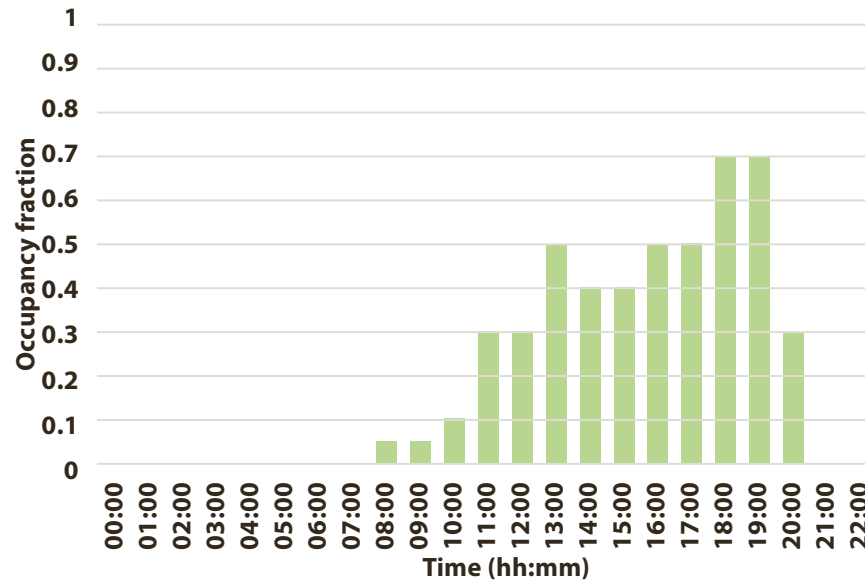
	REFRIGERATION CABINET TYPE	OPEN/CLOSED DOORS	LENGTH [M]	HEAT EXTRACTION RATE [W]	TOTAL ELECTRIC POWER [W] (fans, lighting, anti-mist, defrost)
<b>MEDIUM TEMPERATURE</b>	horizontal	open	2.5	1550	340
			3.75	2325	510
	semi-vertical	open	2.5	3150	77
	serve over	open	2.5	755	962
	vertical	closed	2.5	1625	166
			3.75	2440	252
	vertical	closed	2.5	3195	174
			3.75	5815	260
<b>LOW TEMPERATURE</b>	combined	closed	3.12	1725	4897
	horizontal	closed	2.50	520	2830
	horizontal	open	2.50	2000	3839
	vertical	closed	3.12	1540	4916

**Table 8.2 - Reference values for indoor-controlled temperature of refrigeration rooms.** Source: INRES.

STORED GOODS	MIN TEMPERATURE [°C]	MAX TEMPERATURE [°C]
<b>VEGETABLES</b>	2	8
<b>MEAT, FISH</b>	0	2
<b>SHELLFISH</b>	4	6
<b>CHEESE, MILK, CURED MEATS</b>	2	4
<b>PASTRY</b>	2	4
<b>FROZEN FOOD</b>	-23	-25

- **Occupancy:** The internal gain due to the presence of persons is quantified by considering a specific density of person/m<sup>2</sup> which can generally be considered 0.2 person/m<sup>2</sup> in shops and common areas and 0.25 person/m<sup>2</sup> in food store and anchor stores. In this case it is important to neglect the area occupied by elements preventing the circulation of people. Figure 8.4 shows the typical occupancy profile for a generic shopping centre. Although occupancy density should be different on week-days and weekend.
- **Internal thermal mass:** it is important to consider the thermal mass due to shelves and goods.

**Figure 8.4 - Typical occupancy profile on a weekday.** Source: EURAC.



## 8.2.2 BUILDING ENERGY SIMULATION

Building energy simulation tools allow to assess the impact in terms of energy, power and comfort performance of several retrofitting scenarios. This supports design options with quantitative performance indicators in a planned retrofitting intervention to transform the shopping centres into innovative buildings.

The simulations to be performed via Integrative Modelling Environment allow to implement in the shopping centres different passive/active solutions, such as:

- Passive solutions
- Daylight exploitation
- Ventilative cooling solutions
- Smart coating materials
- Envelope (multifunctional façade)
- Green integration (shadings, roof, façade)
- HVAC systems (boiler, chiller, heat pump, AHU, artificial lighting, etc)

- Refrigeration systems (display cabinets, LT storage, NT storage and cold rooms)
- PV systems (PV panels, standard battery, hydrogen store, catalytic hydrogen boiler, etc.)

Simulation tools also allow to study the energy behaviour of a building under different scenarios:

- **Baseline scenario:** it consists of the actual state of a building and it is the point of reference to make comparisons with the retrofitting solutions proposed;
- **Retrofitting scenario:** it includes solution-sets applied to the envelope or active systems aimed at achieving the best configuration in terms of energy savings, energy efficiency and comfort.

The Integrated Modelling Environment allows to study the whole solution-sets or each single solution.

By means of energy simulations, it is possible to:

- Estimate the energy demand and thermal comfort conditions of the whole building as well as per zone;
- Analyse the accumulated thermal energy over a certain period, considering a system able to provide all necessary thermal power;
- Achieve the comfort desired when the shopping centre is open;
- Identify the maximum hourly heating and cooling peak power;
- Define the temperature trend in each zone;
- Define control strategies which consider the interaction between technologies;
- Estimate the potential energy savings of each solution/solution-set.

## 8.3 MODULAR STRUCTURE OF INTEGRATIVE MODELLING ENVIRONMENT

In the IME<sup>42</sup>, the whole building system is divided into base blocks to work on a user-friendly modelling environment, making the support of the shopping centres retrofitting phases more effective (auditing, design, construction, commissioning and operation). The blocks represent the building and its sub-systems (HVAC, refrigeration, lighting, storage).

The developed IME is able to give information on the building internal conditions (temperature and relative humidity), external weather conditions, sub-systems (HVAC, refrigeration, lighting, PV...) components status, energy consumption, renewable energy production. Starting from these outputs, different indicators can be calculated: comfort, energy, environmental and economic indicators.

The IME can gather in the same simulation deck (i) building, (ii) HVAC + refrigeration systems, daylighting/shading/lighting, (iii) renewable technologies (solar collectors and PV panels), (iv) electric and thermal storages, (v) natural ventilation and infiltration, (vi) control system.

The IME is defined through three levels:

- COMPONENT LEVEL,
- SUB-SYSTEM LEVEL AND
- SYSTEM LEVEL.

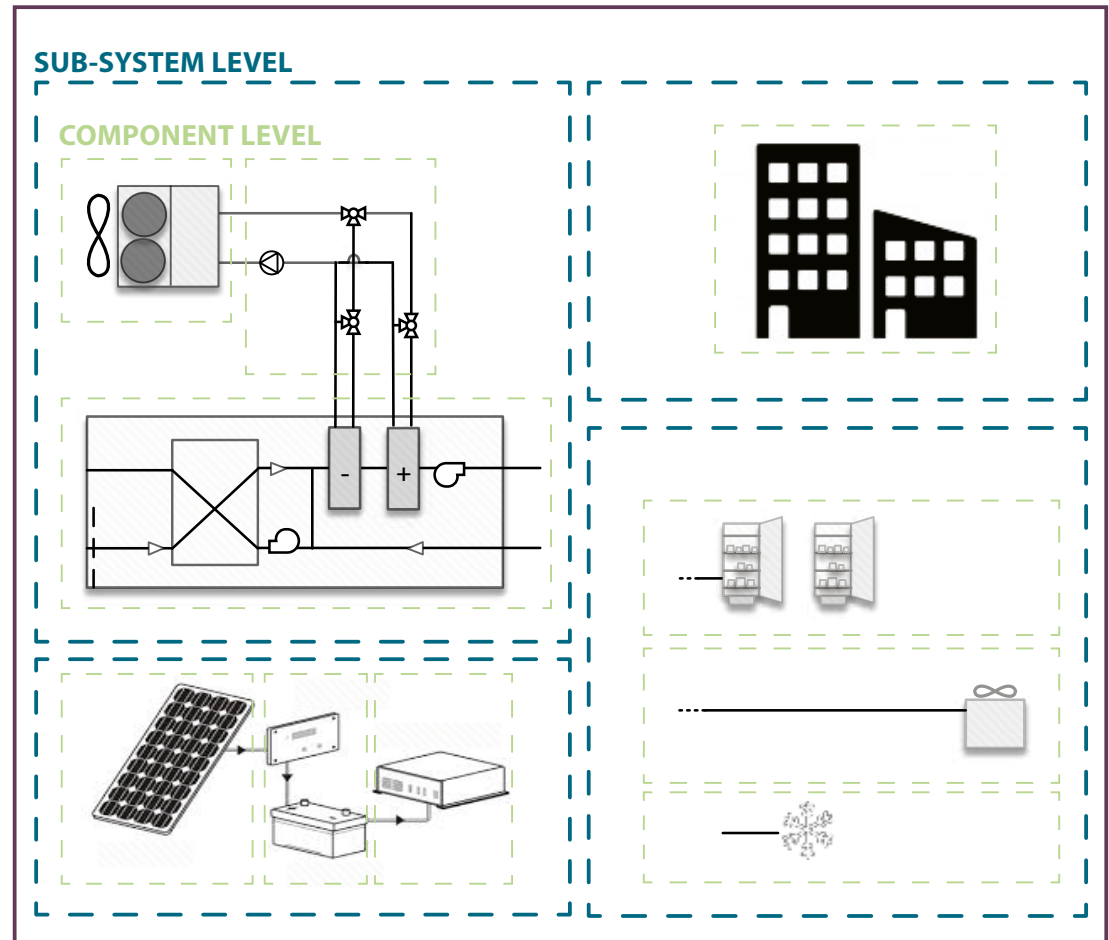
These levels also correspond to the steps followed for the development of a shopping centre model through the IME. Once the sub-systems to be modelled are identified, the first step consists in the definition of the single components or technology of each sub-system. In this phase, the numerical models of the components are selected from the existing libraries of the adopted simulation tool; if not present, a new numerical model is developed. After that, the single component is validated through manufacturer's datasheet, lab tests or

measured data. In a second step, the components of a sub-system are gathered together and an internal control that reproduces the functioning of the single sub-system is developed and implemented. In addition, the components are appropriately sized for the specific system, and control variable as well as set-points are

established. The third step concerns the clustering of the single subdecks in the same model. In this phase, the control rules that regulate the whole system are developed and implemented.

**Figure 8.5 - IME structure levels and development steps.** Source: CommONEnergy.

### SYSTEM LEVEL



<sup>42</sup> Dipasquale C. (2016). Integrative Modelling Environment. <http://commonenergyproject.eu/resources/deliverables>

Table 8.3 summarizes the three levels that make up the IME and the steps to be followed to develop each level.

**Table 8.3 - Methodology for developing a shopping centre model through the Integration Modelling Environment.** Source: CommONEnergy.

LEVEL	ACTIONS
COMPONENT LEVEL	• Numerical model from existing library or code implementation
	• Model calibration/validation
SUB-SYSTEM LEVEL	• Equipment sizing
	• Control variables and set-points definition
	• Sub-system control implementation
SYSTEM LEVEL	• Sub-systems connection
	• Control variables and set-points definition

## REFERENCES

Dipasquale C. (2016). Integrative Modelling Environment. CommONEnergy. <http://www.commonenergyproject.eu/resources/deliverables>

Cambronerio M. V., Antolin J., Haase M., Stenerud Skeie K., Avantaggiato M., Dipasquale C., Belleri A. (2017). Systemic solution-sets. CommONEnergy. <http://www.commonenergyproject.eu/resources/deliverables>

EN15251:2007 Indoor environmental input parameters for design and assessment of energy performance of buildings addressing indoor air quality, thermal environment, lighting and acoustics.

## FURTHER READINGS

ASHRAE. (2011). Procedures for Commercial Building Energy Audits. ASHRAE Edition.

Haase M., Woods R., Mellegard S., Stenerud Skeie K., Lollini R., Noris F., Antolin J. (2015). Main drivers for deep retrofitting of shopping centres. <http://www.commonenergyproject.eu/resources/deliverables>

IBPSA-USA bis. Modelling Best Practice. Building Energy Modelling. IBPSA-USA. Rocky Mountain.

Klein, S.A. et al. (2010). TRNSYS 17: A Transient System Simulation Program. Solar Energy Laboratory, University of Wisconsin. Madison, USA. <http://sel.me.wisc.edu/trnsys>

Dipasquale C., D'Antoni M., Fedrizzi R., Kummert M., Marletta L. (2013). Procedure for buildings energy modelling suited for integrated control simulation. Paper in proceedings. BSA 2013. Bolzano, Italy.



# 9.

## OPTIMIZED BUILDING ENVELOPE AND ARCHITECTURE

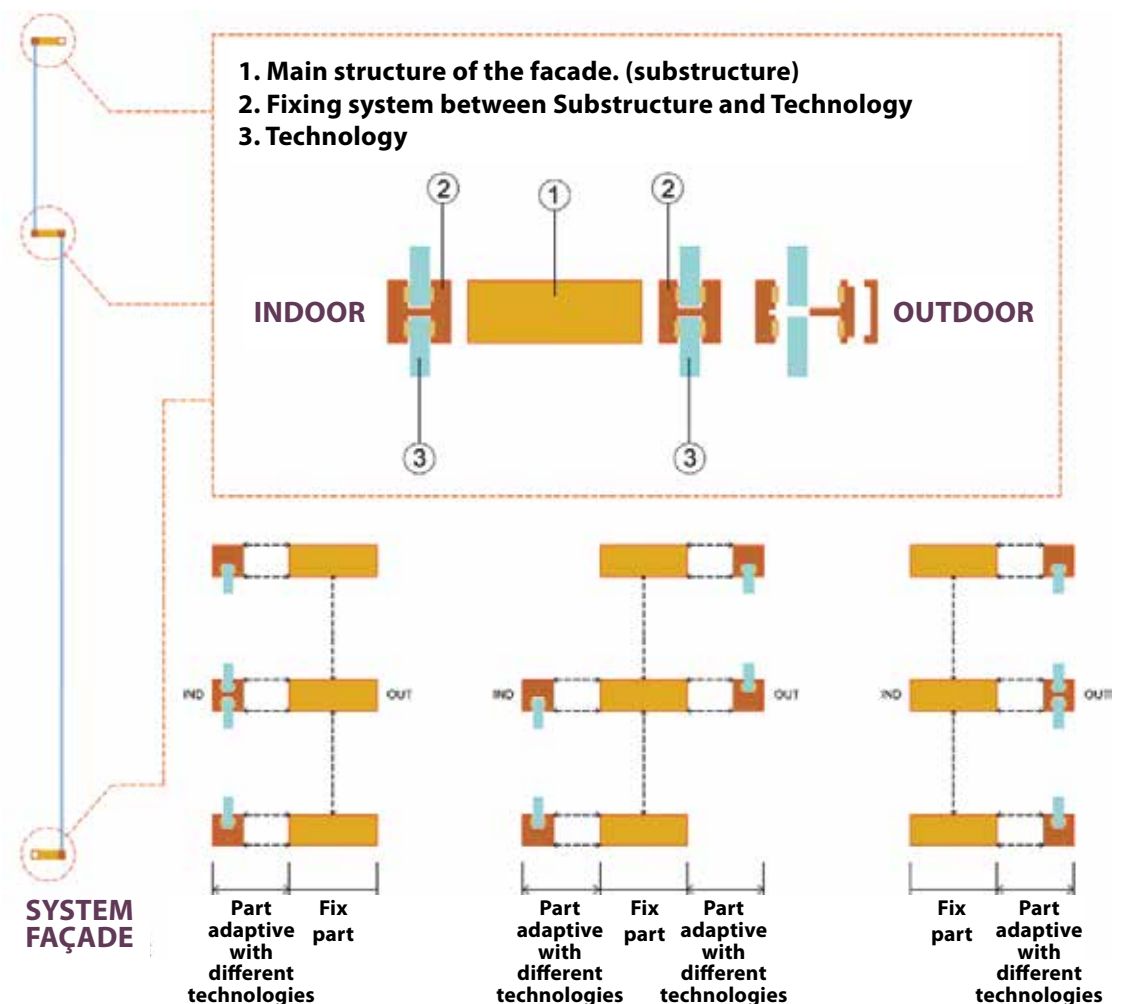
### 9.1 FAÇADE FUNCTIONS INTEGRATION

Considering the special load profiles in a shopping centre, driven by marketing, comfort and energy efficiency reasons, the façade design development is a very important process. In order to analyse different technologic solutions and define, in relation to the climate condition and needs of the building, the best retrofitting solution, we proposed a modularity and flexible way to draw up a façade scheme. Figure 9.1 shows a simplified outline of the façade structure configuration. It contains a main structure or substructure, responsible for allocating, weights and loads of all technologies within the system.

The façade system is a structural core that allows flexibility when incorporating strategies and technologies, guaranteeing some requirements, like to avoid the thermal bridge or the heat flow between the outside and inside. On the other hand, the elements that make up this structure should be finished with a mechanical solution, as standardized as possible.

This fixing system should include different connector's adaptations for the usual elements of a façade system, such as windows, corners, roof trim, etc. Apart from this, it must also provide solutions for the final finishing of the joint, obtaining hidden solutions, semi-hidden or views.

**Figure 9.1 - The initial outline to the concept on façade structure.** Source: Acciona Construction, R&D Department.



The fastening system between the main structure (substructure) and the technology must be a set of elements or parts, which achieve the fastening of the technology and establish a strong connection with the substructure. This makes it possible to define the best strategies of each situation that will be as standardized as possible.

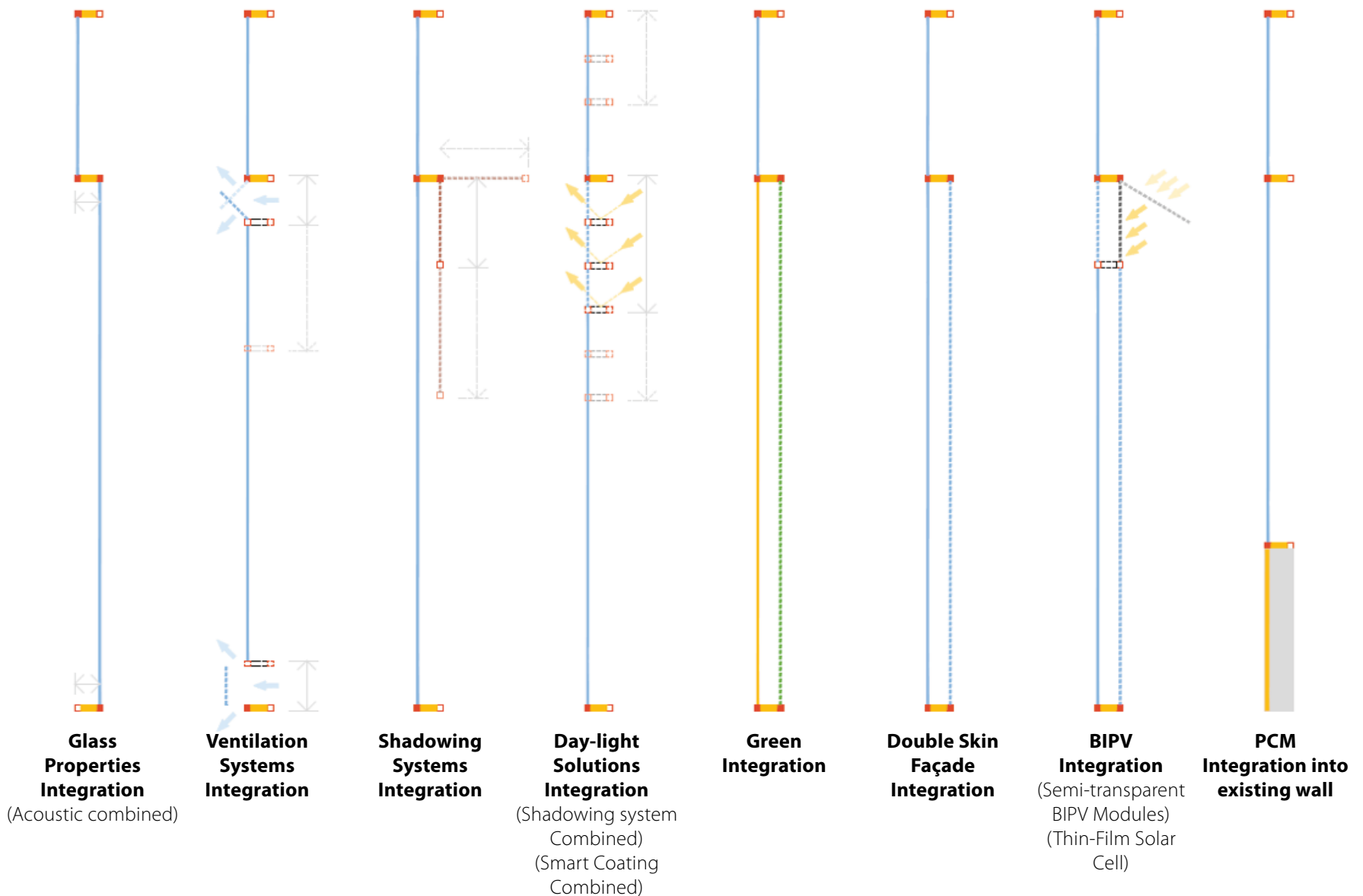
Apart from this, it must also provide solutions for the final finishing of the joint, obtaining hidden solutions, semi-hidden or views.

Within the façade scheme, it should be possible to modify the configuration of the glazing systems technology (double, E-low, triple glazing...),

positions inside the façade, optical characteristics, modular configuration, thermal insulation or solar control of the radiation, Figure 9.2

**Figure 9.2 - Proposition on different strategies integration into the façade structure.** Source: Acciona Construction, R&D Department.

**BASIC OUTLINE FOR TECHNOLOGIES INTEGRATION**



Furthermore, within the façade scheme, it is possible to include and value passive solutions, such as natural ventilation or green integration, or RES technologies such as photovoltaic.

For natural ventilation, solutions considering the duplication of profiles were proposed, uprights or crossbars, to set the location of folding glass sheets allowing the flow of indoor / outdoor air. With this system, the folding areas could be located at any height, depending on the location or direction of the estimated airflow. A quite flexible and adaptable solution.

The integration of vegetal façades gives the strategy a solution to protect the building against prevailing winds.

The system performed allows integration and exploitation of the energy efficiency technologies, increasing the energy potential of the façade retrofitting, allowing the reduction of the future energy demand. The system is communicating with the building iBEMS, working as a high-level controller, increasing the system energy efficiency and adaptation to particular climatic conditions along the day, week, month, year. On the other hand, it may allow the energy exchange between systems as well as using the energy losses of other building systems.

The main benefit is the energy savings that traduce directly in cost savings in the building exploitation. The system was assessed through numerical simulations and experimental campaign using outdoor testing facilities, enabling to evaluate both functionality and performances, considering the goals of modularity, adaptivity, and multi-functionality.

### 9.1.1 PRACTICAL EXAMPLE

The façade design was established, able to support modularity, and flexible to integrate any of the energy-efficient strategy (in continuation strategy), adapting better to the climate or thermal needs of the building to be retrofitted.

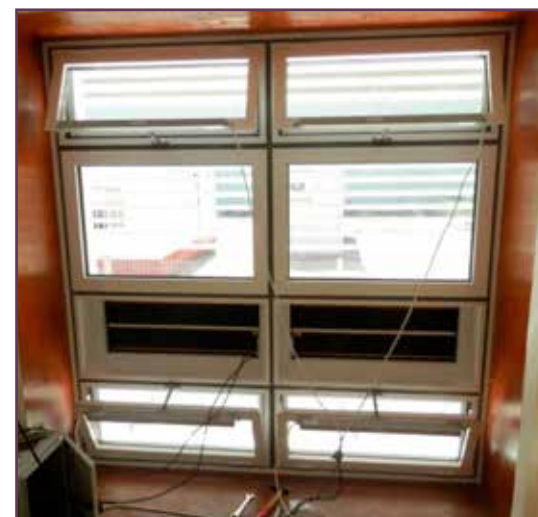
Strategies to integrate the solutions were proposed after analysing what the main concept of the façade system should be to be able to adapt to the different retrofitting project needs, with an energy-positive impact.

The product developed is a **climate modular multifunctional façade system for retrofitting applications**, with a parametric structure that allows tailoring the façade features depending on: (i) climate conditions; (ii) building functions; (iii) local building code and (iv) heritage constraints.



**WITHIN THE FAÇADE SCHEME, IT IS POSSIBLE TO INCLUDE AND VALUE PASSIVE SOLUTIONS, SUCH AS NATURAL VENTILATION OR GREEN INTEGRATION, OR RES TECHNOLOGIES SUCH AS PHOTOVOLTAIC.**

**Figure 9.3 - Multifunctional façade energy prototype installed into the laboratory building of ACCIONA in Sevilla (Spain) (left), façade prototype system with the motors installed and connected under monitoring (right).** Source: Acciona Construction, R&D Department.





The façade has a light weight sub-structure and allows fast assembly possibilities, but also gives the unique opportunity to adjust the system to local climate conditions and to urban characteristics through its flexible and modular system.

Some features of the technology include the adequate proportion between the opaque and transparent surfaces, shading systems to control and

exploit solar gain, thermal storage, RES integration, single and double skin systems with proper air gap integration and giving ventilation possibilities.

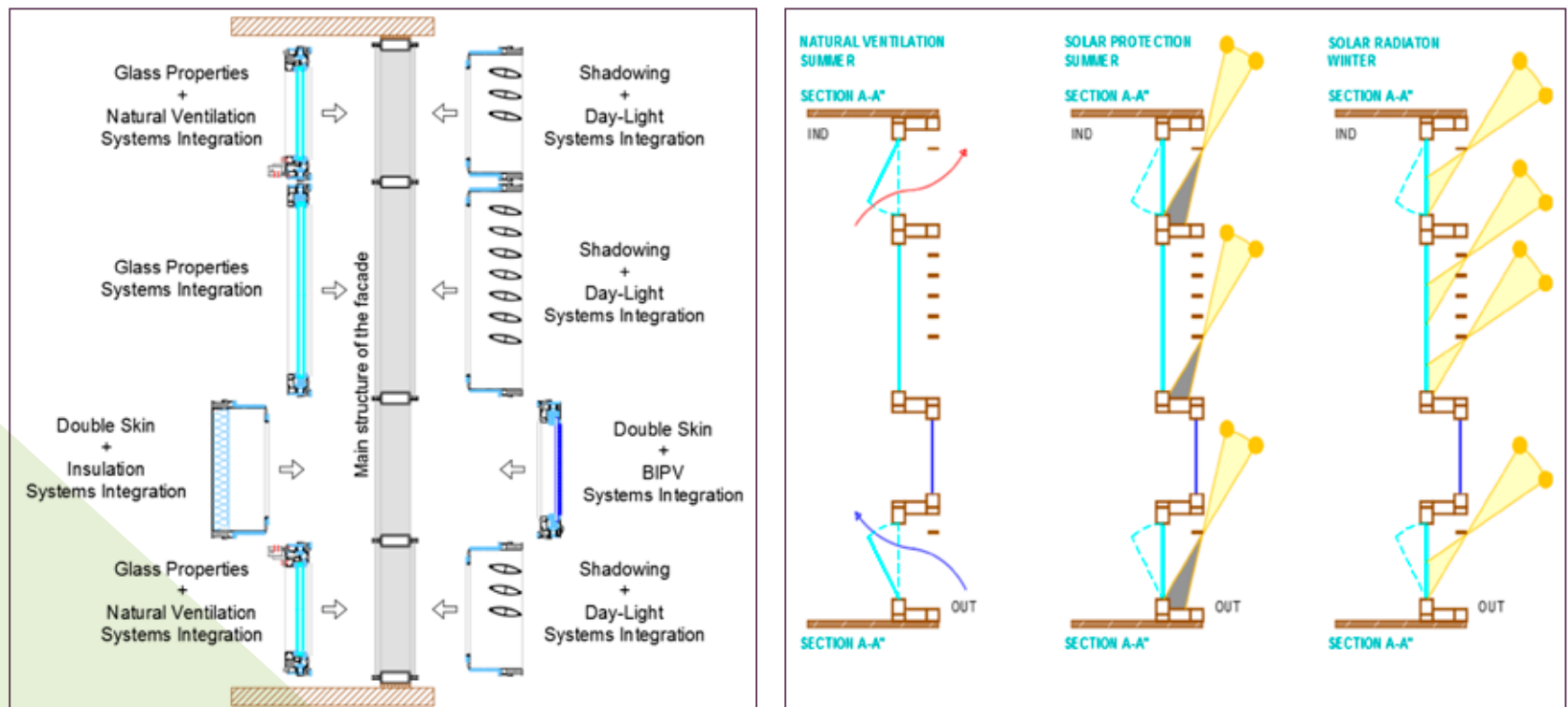
This creates a façade concept that can function actively or passively, through the management of climatic factors and exploitation of local sources.

This main structure, as part of allocating weights and loads of all technologies integrated, must be in charge

of breaking the thermal bridge, eliminating the heat flow between the system's outside and inside.

On the other hand, the elements that make up this structure must be completed with a mechanical solution, as standardised as possible, with the fixing system attached to any of their edges.

**Figure 9.4 - Multifunctional façade energy concept design scheme (left), different functions for strategies on natural ventilation and solar protection scheme (right).** Source: Acciona Construction, R&D Department.



In continuation, for solar protection, integration solutions included:

- The implementation of horizontal or vertical elements in the outer part of the system (with different lengths and widths according to the different local solar situations and climates).
- The possibility of increasing the number of the horizontal profiles or crossbars of the façade system itself, adaptive depending on high or low solar requirements. This solution can be combined with natural lighting strategies (varying in materials or finishing), which reflect in greater or lesser measure the solar radiation into the building. The possibility of integrating the photovoltaic technology as a shading element was also analysed.
- Finally, opaque solutions were proposed. Those can incorporate thermal insulation solutions (with different material), located in the space between the structural system profiles, with different exterior and interior finishes. The variant to this is a combined use of pcm in both the insulation and the interior finish layers (solutions that are easily integrated into the façade system).

## 9.2 MULTIFUNCTIONAL COATING

### 9.2.1 MULTIFUNCTIONAL COATING ADDITIVE

Coatings are generally used in their many forms mainly for aesthetic reasons, but recently, specialized coatings were developed to address problems in the building envelope.

These problems are related to mould, water penetration and, lately, solar reflection as well as thermal and sound insulation.

Even so, no coating or paint exists to address all problems with multiple or combined properties, to reduce the application time, as well as reduce short or long-term building operative costs by its sole application.

Therefore, in the framework of CommONEnergy, a new multi-functional formulation was developed for an additive with advanced surface properties suitable to be integrated to any aqueous-based paint (for almost every substrate, excluding glass and laminated surfaces such as wood, plastics, etc. which have been excluded from this research due to the synthesis of the resins used for their production, as proved to be incompatible with the multi-functional formulation synthesis).

The final user thus has the ability to pick from a list of properties those suitable for the climate conditions of his/her area, and just add the formulation in the desired commercial coating product.

The possible characteristics that the final user can choose from are:

- I. THERMAL BEHAVIOUR ENHANCEMENT
- II. IR REFLECTIVE OR IR ABSORBING
- III. ANTI-BACTERIAL / ANTI-MOULDING
- IV. SELF-CLEANING / VOC ELIMINATION
- V. HYDROPHILICITY / HYDROPHOBICITY

### 9.2.2 PICKING OF SUITABLE CHARACTERISTICS

Some examples of the different properties that could be useful in terms of energy and cost efficiency, for different climate conditions can be found in Table 9.1.

**Table 9.1 - Coating properties for different climate conditions**

CLIMATE CONDITIONS	COATING PROPERTIES
Dry, warm, high irradiation	IR-Reflective, Self-cleaning, Insulating
Medium precipitation, low humid, warm, high irradiation	IR-Reflective, Anti-mould, Insulating, Self-cleaning
Rainy, medium humidity, warm	Anti-mould, Insulating, Self-cleaning
Rainy, medium humidity, mid-temperatures	Anti-mould, Insulating, Self-cleaning
High precipitation, high humidity, medium irradiation	Anti-mould, Insulating, Self-cleaning
Very high precipitation, high humidity, medium irradiation, medium temperatures	Anti-mould, Insulating, Self-cleaning
Medium precipitation, high humidity, low irradiation, low temperatures	IR-Absorbing, insulating, Anti-mould
Very high precipitation, medium humidity, very low irradiation, very low temperature	IR-Absorbing, insulating, Anti-mould



COATINGS ARE GENERALLY USED IN THEIR MANY FORMS MAINLY FOR AESTHETIC REASONS, BUT RECENTLY, SPECIALIZED COATINGS WERE DEVELOPED TO ADDRESS PROBLEMS IN THE BUILDING ENVELOPE.

### **9.2.3 CHARACTERISTICS EVALUATION**

In the framework of the project and with the aim to test the achieved results, many different samples were created and tested for their visual properties, porosity, water absorption, water steam permeability, coating hardness, coating adhesion, thermal behaviour, anti-mould / antibacterial behaviour and their self-cleaning properties.

From those tests, a reduction of porosity in the total sample area was achieved, which in case of cement reaches 23.05% and, in lightweight concrete, 22.72%.

The water absorption behaviour was improved by up to 81,82% (Portland cement), while a high grade of improvement in water steam permeability was noticed, where values indicated steam water transmission well below 20%.

Moreover, the coating archived high shore D hardness, with values above 60, which considers being industry standard while the adhesion capability for all samples was within manufacturers' standard, as the percentage area removed < 5% and is classified as CAT 4b.

A significant decrease (on average 11.33%) of the measured temperature was recorded on the back

side of the samples, and a high reflectance value reaching 93,98% in case of steel sample to 89.12% for the elastomer membrane was achieved.

Finally, coated substrates maintain their anti-moulding properties as they can be categorized as CAT 2 substrates (coatings).

Their antibacterial activity exceeds  $\log >2.00$ , indicating high antibacterial protection while maintaining the hydrophilicity as recorded during the DSA test. It was also found to be active in the photocatalytic degradation of nicotine and, as a conclusion, to the most organic pollutants.

#### **9.2.3.1 Practical test - Benefits**

By using this kind of coating additive, a decrease in the energy consumption can be achieved, as the IR reflecting or absorbing technology could lead to a reduction of up to 50% of the energy cost for heating or cooling. This was especially the case for the area of Catania, one of the project reference buildings where simulations were performed with the TRNSYS model: a time to ROI of less than three years was calculated.

Moreover, coatings with hydrophobic and IR characteristics form a barrier against harmful UV

radiation and add an additional layer of weather and moisture protection which reduces the substrate's fatigue.

The antibacterial properties of the coating add the ability to form a protective shield against mould and algae growth.

These factors add up to extend the life of the substrate materials, especially for membranes in roof applications.

Environmental benefits associated with the use of sustainable coatings extend beyond the energy savings. As a result, lowering the ambient temperature of the roof can contribute to reduced smog in urban areas.

Besides the obvious cost savings, longer lasting construction materials mean less waste going to the landfill.

### **9.2.4 APPLICATION GUIDELINE**

Due to the complexity of this innovation material, "Application Guidelines" are reported in Annex I.



**BY USING THIS KIND OF COATING ADDITIVE, A DECREASE IN THE ENERGY CONSUMPTION CAN BE ACHIEVED.**

## 9.3 GREENERY INTEGRATION

Contrary to green technologies, greenery integration means a direct use of vegetation to improve the building's thermal performance. In addition to the common vision that plants improve the aesthetic value of a building, they can improve the building thermic framework.

A specific opportunity is the green façade concept, where the façade - or parts of it - is covered with vegetation. The vegetation placed on the façade may partly stop the absorption of solar irradiation on the wall surface. It may also influence the convection of heat transferred to/from the wall.

To integrate greenery on a building, one shall choose the façade elements where the plants shall be placed, to select the proper plant and corresponding façade technology.

**The main benefits of this technology** are the improvement of heat transfer across the wall or roof and the enhancement of a microclimate (better oxygenation and air humidity, CO<sub>2</sub> and pollution absorption).

A measurable added value is the moderation of heat transfer through the wall –equivalent to an insulation improvement.

In CommONEnergy, foliage mounted on façade wiring was investigated. A tremendous decrease of the **annul heat absorption on the 1m<sup>2</sup> of façade** was noticed: **35% of solar irradiation directed onto the façade was dissipated in the foliage (layer of leaves)**. When lower latitude geographical zones are considered, that result could even reach 80%. The lower impact – up to 2% - is to be expected for heat transferred out of the building indoor. That is mostly the effect of a decrease in air movement around the wall, thanks to a labyrinth of leaves and branches.

Shopping centres differ from regular buildings with their high heat gain caused by lighting, refrigeration and dense streams of people. It is almost reaching the energy sources saturation, a custom of industry buildings. Here HVAC is the must. However, the decrease of heat transfer through the façade may remarkably decrease the power consumption of HVAC systems. Besides HVAC energy savings, the microclimate on shopping centres obviously improves with better humidity level, lower wind velocity and air temperature.

Even if the energy impact is notable, one may not forget the greenery influence on human beings environment – both psychological and climatic. Deep, long-lasting relationships between human and nature implies that most people perceive plants as 'nice looking' elements. In fact, **it influences humans' hormone system leading into holistic stress reduction and good mood increase**. Moreover, an introduction of green, living elements to the building's envelope and interiors leads to customers' space perception as more prestigious and elegant. And good mood inspires shopping willingness. However, this is only a qualitative dimension and detailed parametric research results are not available.

**The heat performance** of greenery solutions strongly depends on climate conditions driven by temperature, solar irradiation parameters, rain fall, height above sea level, winds and seasons length. The plant selection shall be made carefully including the vegetation period, hardiness and environmental zones, and finally maintenance costs. The straightforward interpolation of solutions across different climate and geographical zones does not work properly.

In addition, the selection of façade "faces" for greenery integration is important to ensure the solution efficiency; commonly those faces shall

be blind, favourably facing NE-SE and NW-SW directions. However, when one considers high-latitude geographical zones, S directed faces are favourable. That is due to a strong correlation between the biological diversity and climate constraints.

**The efficient greenery integration on the façade has to be done together with a detailed feasibility study to predict the final performance– both technical and economical.** The relevant study should be done with a dedicated simulation software, where green building components are available for study<sup>43</sup>. When using the TRNSYS software for building energy balance prediction, one may use the dedicated Vertical Foliage Component for greenery integration energetic results<sup>44</sup>.

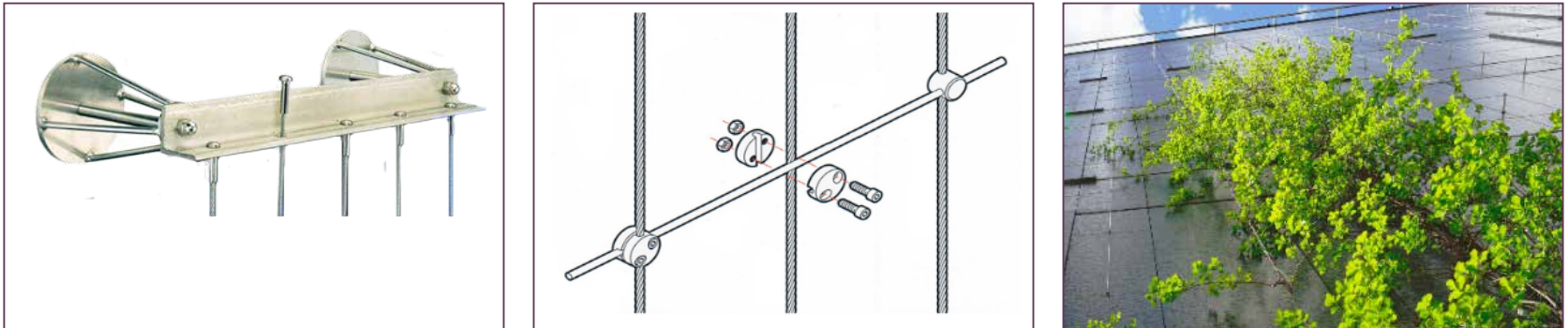
As far as the solution feasibility is concerned, the best results are met when one uses the so-called green wall – a climbing plant growing in the soil on the building outer limits and fixed on the blind façade with a wiring system. That solution is easy for commissioning and de-commissioning, reasonably loads the building structure in comparison with panels and pot systems (including roof solutions). Finally, its maintenance is easy and cheap.

That solution seems to be particularly well-suited for façade thermic improvement – most shopping centres have low-quality wall insulation and foliage is a good alternative to costly improvement of thermal insulation – particularly, when a decrease of heat transfer from the outer space is needed (solar energy absorbance in foliage) or with an increase of the heat transfer from the inner space of building (surplus energy of building heat gain).

<sup>43</sup> Krzysztof Grabowiecki, Armen Jaworski, Tomasz Niewczas, Annamaria Belleri. (2017). Green solutions- climbing vegetation impact on building – energy balance element. Energy Procedia 111. 377 – 386.

<sup>44</sup> [http://commonenergyproject.eu/uploads/biblio/document/file/1425/FLYER\\_05\\_GREENERY\\_FINAL.pdf](http://commonenergyproject.eu/uploads/biblio/document/file/1425/FLYER_05_GREENERY_FINAL.pdf)

**Figure 9.5 - Greenery integration: vertical foliage and fixing elements.** Source: CIM-mes.



Greenery integration on shopping centres is easy. The façade face selected for the integration should in principle be blind. It should face NE-SE and NW-WE. The free-soil surface should be available at the wall bottom (or some bowls on the pavement should be considered). That would allow to get installation and maintenance of plants feeding as more natural.

Feeding and watering (fertilizing) scheme is a must, when considering public vegetation and some functional goals. When plants are not fertile in the proper way, their characteristics drop down and effects (e.g. on building's energetic balance) may diminish as well. Also, natural watering has to be completed with an artificial one and the soil possibly enriched with hydrogel. It provides roots with the oxygen they need during wet weather when soil is soaked and water during droughts.

The investment costs vary, depending on the country, between 75 – 130 €/m<sup>2</sup> and the expected Return of Investment (ROI) reach 1-2 years case by case:

- Plant – 5-10€/1m
- Structure elements including mounting 1m<sup>2</sup> – 70 140 €/ m<sup>2</sup>

Estimated maintenance costs (cleaning, watering, cutting) should not be higher than 1m<sup>2</sup> - 10-20€/m<sup>2</sup>/a.



---

CONTRARY TO GREEN TECHNOLOGIES, GREENERY INTEGRATION MEANS A DIRECT USE OF VEGETATION TO IMPROVE THE BUILDING'S THERMAL PERFORMANCE. IN ADDITION TO THE COMMON VISION THAT PLANTS IMPROVE THE AESTHETIC VALUE OF A BUILDING, THEY CAN IMPROVE THE BUILDING THERMIC FRAMEWORK.

---



**Multifunctional coating as tested on the roof of Modena Canaletto, Italy.** Source: CommONEnergy.



Natural ventilation and ventilative cooling as applied in City Syd, Trondheim, Norway. Source: CommONEnergy.

# 10.

## NATURAL VENTILATION AND VENTILATIVE COOLING

Ventilative cooling can be defined as:



THE USE OF NATURAL OR MECHANICAL VENTILATION STRATEGIES TO COOL INDOOR SPACES. THIS EFFECTIVE USE OF OUTSIDE AIR REDUCES THE ENERGY CONSUMPTION OF COOLING SYSTEMS WHILE MAINTAINING THERMAL COMFORT. THE MOST COMMON TECHNIQUE IS THE USE OF INCREASED VENTILATION AIRFLOW RATES AND NIGHT VENTILATION, BUT OTHER STRATEGIES MAY BE CONSIDERED AS WELL.

Beyond the consistent energy savings and the power-peak shaving, natural ventilation improves thermal comfort sensation thanks to:

- Enhanced interaction between the building and the outdoor environment: recent trend in shopping centre architecture is the use of semi-outdoor ventilated galleries as customers are looking for a more outdoor experience<sup>45</sup>;
- Higher adaptation ability of building occupants: research on thermal comfort demonstrated that occupants of naturally-ventilated buildings feel comfortable when indoor temperatures closely reflect the outdoor climate<sup>46</sup>. Generally building occupants prefer natural airflow to air-conditioned areas;
- Increased air velocity: thermal comfort ranges during summer can be increased thanks to increased air velocity (EN 7730: 2005<sup>47</sup>).

A higher indoor environment quality offers opportunity for further profits from customers (through sales increase, higher dwell time, footfall etc.) and workers (through lower retail worker absenteeism, staff turnover, etc.) experience. Several factors drive customer satisfaction and the choice of a shopping centre over another, among which a pleasant atmosphere, the location and access to a

free parking<sup>48</sup>. An important point is that customers do not look at the energy efficiency of a shopping centre when choosing where to shop<sup>49</sup>. Although the amount of research on the relationship between customer experience with the indoor environment and sales or dwell time is limited at this time. The World GBC is promoting a Retail Metric Framework<sup>50</sup> which aims to better inform design decisions by a manageable set of metrics. These metrics link environment parameters (indoor air quality, thermal comfort, lighting, acoustics) to customers and employees' experience and economics for retailers.

A ventilative cooling strategy involves the whole building envelope (as vent and openings can be located both on façade and roof) to exploit the buoyancy due to temperature difference between shops and central spaces and along the atrium height.

Ventilative cooling can be designed and applied to both new and existing buildings and to residential and non-residential buildings. Obviously, the design of a ventilative cooling strategy as retrofit solution is strictly dependent on the building shape, the internal distribution of spaces and functions and the interaction with outdoor environment, as well as climate conditions.

<sup>45</sup> BCSC Retail leading property. (2014). Guidance note 68 - Shopping centre natural ventilation design. [Online] [http://research.bsc.org.uk/sustainability/publication.asp?pub\\_id=459](http://research.bsc.org.uk/sustainability/publication.asp?pub_id=459)

<sup>46</sup> De Dear R, Brager G, Cooper D. (1998). Developing an adaptive model of thermal comfort and preference. RP-884 ASHRAE. [Online] <http://www.cbe.berkeley.edu/research/other-papers/de%20Dear%20-%20Brager%201998%20Developing%20an%20adaptive%20model%20of%20thermal%20comfort%20and%20preference.pdf>

<sup>47</sup> EN ISO 7730: 2005 Ergonomics of the thermal environment – Analytical determination and interpretation of thermal comfort using calculation of the PMV and PPD indices and local thermal comfort criteria.

<sup>48</sup> Haase M., Stenerud Skeie K., Woods R., Mellegård S., Schlanbusch R. D. (2015). Typical functional patterns and socio-cultural context. [http://www.commonenergyproject.eu/uploads/deliverable/file/3/WP2\\_D2.3\\_20150131\\_P07\\_Typical\\_functional\\_patterns\\_and\\_socio\\_cultural\\_context\\_NotPrintable.pdf](http://www.commonenergyproject.eu/uploads/deliverable/file/3/WP2_D2.3_20150131_P07_Typical_functional_patterns_and_socio_cultural_context_NotPrintable.pdf)

<sup>49</sup> Woods R., Mellegård S., Schlanbusch R. D., Stenerud Skeie K., Haase M. (2015). Shopping malls inefficiencies. [http://www.commonenergyproject.eu/uploads/deliverable/file/2/WP2\\_D2.2\\_20150130\\_P07\\_Shopping\\_malls\\_inefficiencies\\_NotPrintable.pdf](http://www.commonenergyproject.eu/uploads/deliverable/file/2/WP2_D2.2_20150130_P07_Shopping_malls_inefficiencies_NotPrintable.pdf)

<sup>50</sup> WorldGBC. (2016). Health, Wellbeing and Productivity in Retail: the impact of green buildings on people and profit. WorldGBC's Better Places for People. [Online] <http://www.worldgbc.org/files/7114/5444/1490/FinalReport-Jan2016New.pdf>



The potential of ventilative cooling strategies can be evaluated using the ventilative cooling potential tool<sup>51</sup>. The tool, developed within the IEA EBC Annex 62 research project<sup>52</sup> takes also into account building envelope thermal properties, internal gains and ventilation needs.

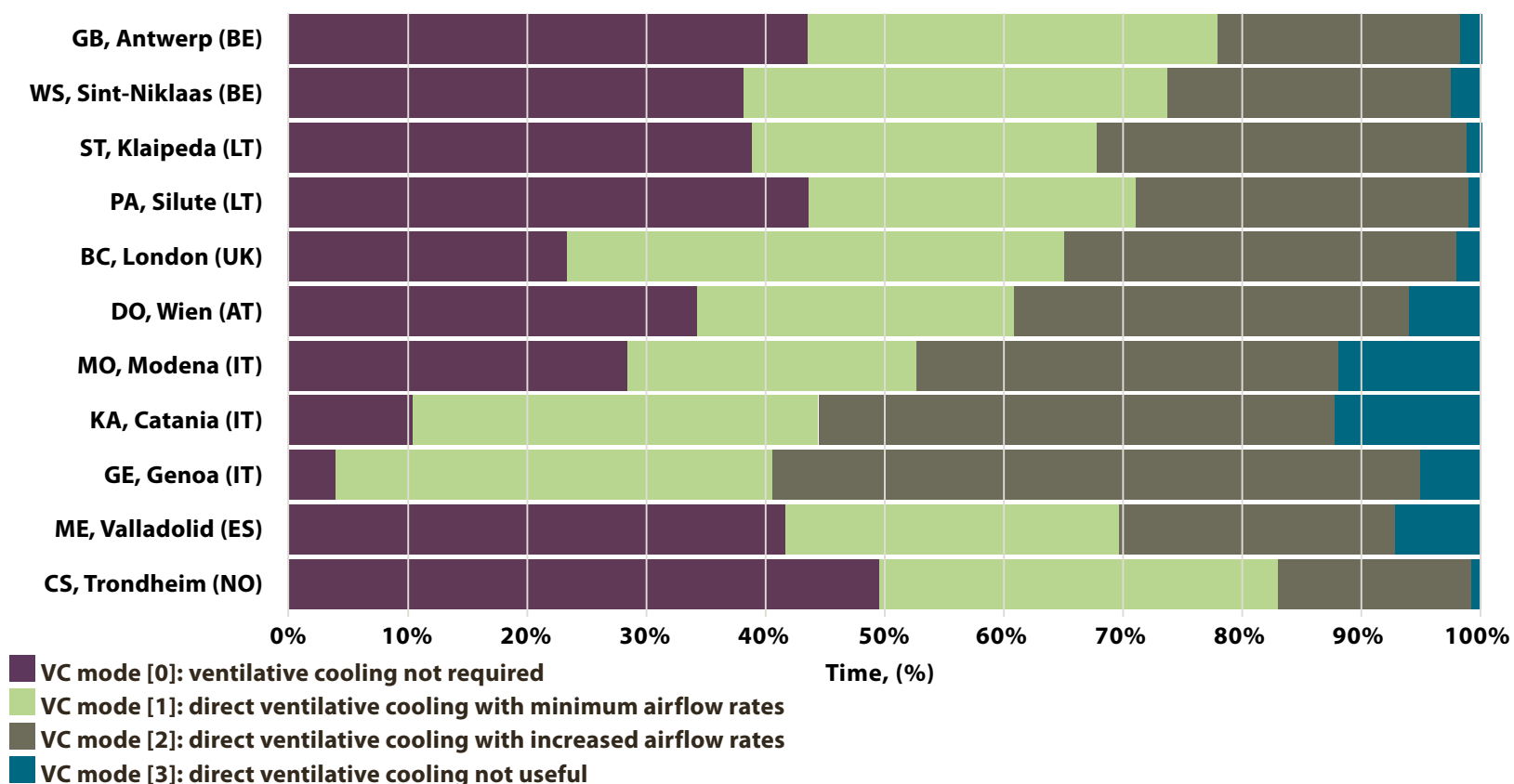
For each hour of the annual climatic record of the given locations, an algorithm splits the total number of hours when the building is occupied into the following groups:

- Ventilative Cooling mode [0]: no ventilative cooling is required as heating is needed;
- Ventilative Cooling mode [1]: natural ventilation can be exploited to meet the minimum ventilation rate required by the EN 15251<sup>53</sup> on indoor environmental quality;
- Ventilative Cooling mode [2]: ventilative cooling is needed and the ventilation rates needed to maintain indoor air conditions within the comfort ranges (calculated according to the adaptive comfort model – EN 15251<sup>54</sup>) are assessed according to the energy balance;
- Ventilative Cooling mode [3]: ventilative cooling is not useful and night-time ventilation should be considered.

The graph in Figure 10.1 reports the results obtained from a ventilative cooling potential analysis, made at 11 reference buildings with a base-level of internal gain of 30 W/m<sup>2</sup>, typical of renovated shopping centres. The higher the level of specific internal gains, the higher the cooling need – consequently, the energy savings related to the use of ventilative cooling potential are higher.

**Figure 10.1 - Percentage of hours within a year when direct ventilative cooling is required, useful or not useful in the reference buildings climates.**

Source: EURAC.



<sup>51</sup> Belleri A. Psomas T., Heiselberg P. (2015). Evaluation tool of climate potential for ventilative cooling [Conference] // 36th AIVC- 5th TightVent- 3rd venticool. - Madrid : [s.n.].

<sup>52</sup> IEA EBC Annex 62. Ventilative Cooling research project. [Online] <http://www.iea-ebc.org/projects/ongoing-projects/ebc-annex-62/>

<sup>53</sup> EN 15251:2007 Indoor environmental input parameters for design and assessment of energy performance of buildings addressing indoor air quality, thermal environment, lighting and acoustics.

<sup>54</sup> EN 15251:2007 Indoor environmental input parameters for design and assessment of energy performance of buildings addressing indoor air quality, thermal environment, lighting and acoustics.

Based on a climate analysis, the most suitable ventilation strategy can be assigned by identifying possible airflow paths, the air intake and exhaust locations. It is necessary to integrate the natural ventilation in the overall building design, especially in relation to area partitioning (shops, common areas, areas closed to visitors), air tightness, building geometry, HVAC system and envelope porosity.

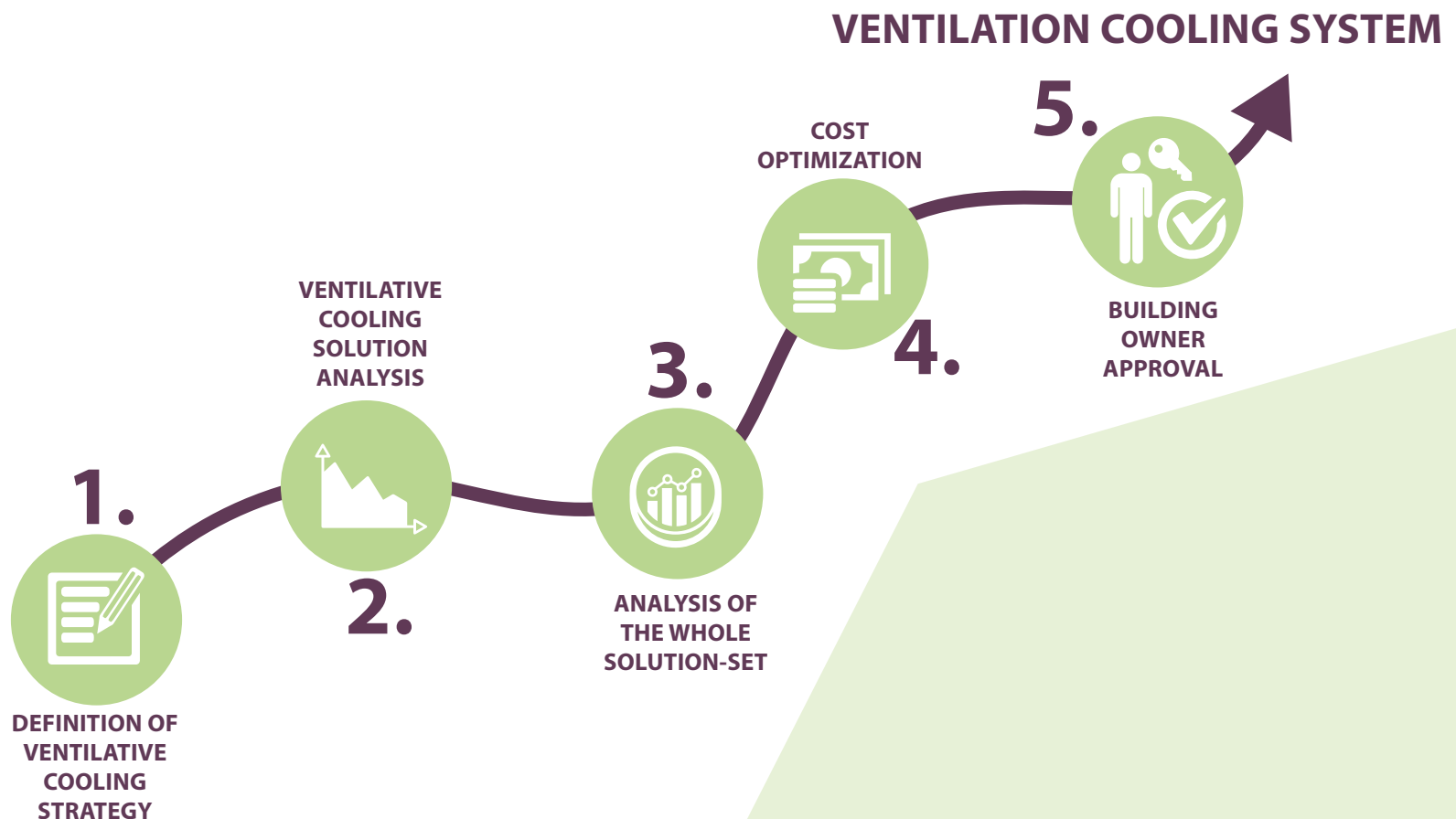
Considering that shopping centres' indoor areas highly interact among each other, an airflow multizone-based analysis is needed to evaluate the ventilative cooling strategy effectiveness and to assess potential energy savings.

The building simulation model allows to evaluate energy savings in terms of cooling need and number of activation hours of the mechanical ventilation system, as well as the interaction with other solutions. In the design phase, airflow components can be properly sized to reach the target flow.

A cost-optimization can be performed by comparing the investment cost with the predicted energy saving (at this stage, not considering the hard-to-quantify but nonetheless important effects such as enhanced customers' experience and higher real-estate value).

A parametrization of the opening area helps defining the most cost-effective number of openings.

**Figure 10.2 - Path to design a ventilation cooling system.** Source: EURAC.



Since the ventilative cooling strategy involves different building systems (i.e. door and window actuators, air-handling unit, cooling system), control schemes are implemented into the intelligent Building Energy Management System (iBEMS).

## 10.1 CASE STUDIES

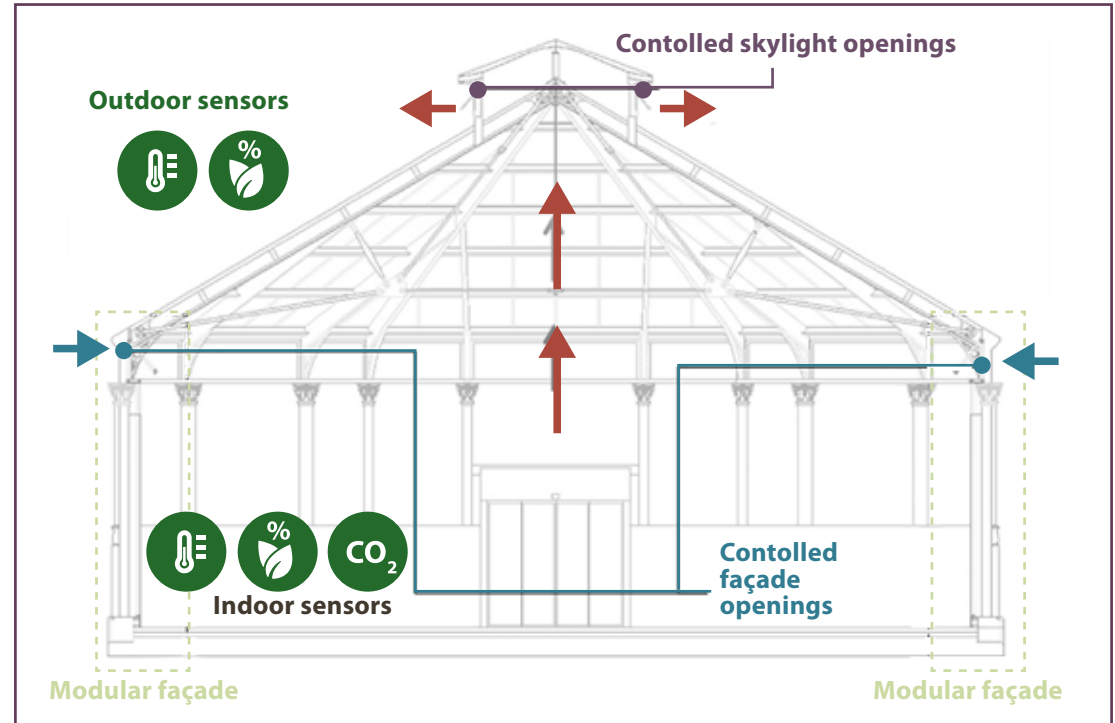
Following the design procedure, ventilative cooling scenario solutions have been designed and implemented on two demo cases: Mercado del Val (Valladolid) and CitySyd (Trondheim).

### MERCADO DEL VAL

The ventilative cooling solution developed for the Mercado del Val (Figure 10.3 - Figure 10.4) exploits openings in the modular multifunctional façade and in the skylight to promote stack effect ventilation. Simulation results showed up to 40% potential energy savings for the mixed-mode ventilation strategy compared to the fully-mechanically-ventilated baseline over the total consumption for heating, cooling and ventilation.

Natural ventilation can also ensure minimum required air change rates to keep an acceptable level of indoor air quality. The optimal number of openable windows was suggested by trading-off energy, comfort and cost aspects.

**Figure 10.3 - Building cross section with openings location and possible sensors for the control strategy of natural ventilation in the Mercado del Val democase.** Source: EURAC.



**Figure 10.4 - Interior view of the Mercado del Val with façade and skylight openings.** Source: EURAC



## CITY SYD

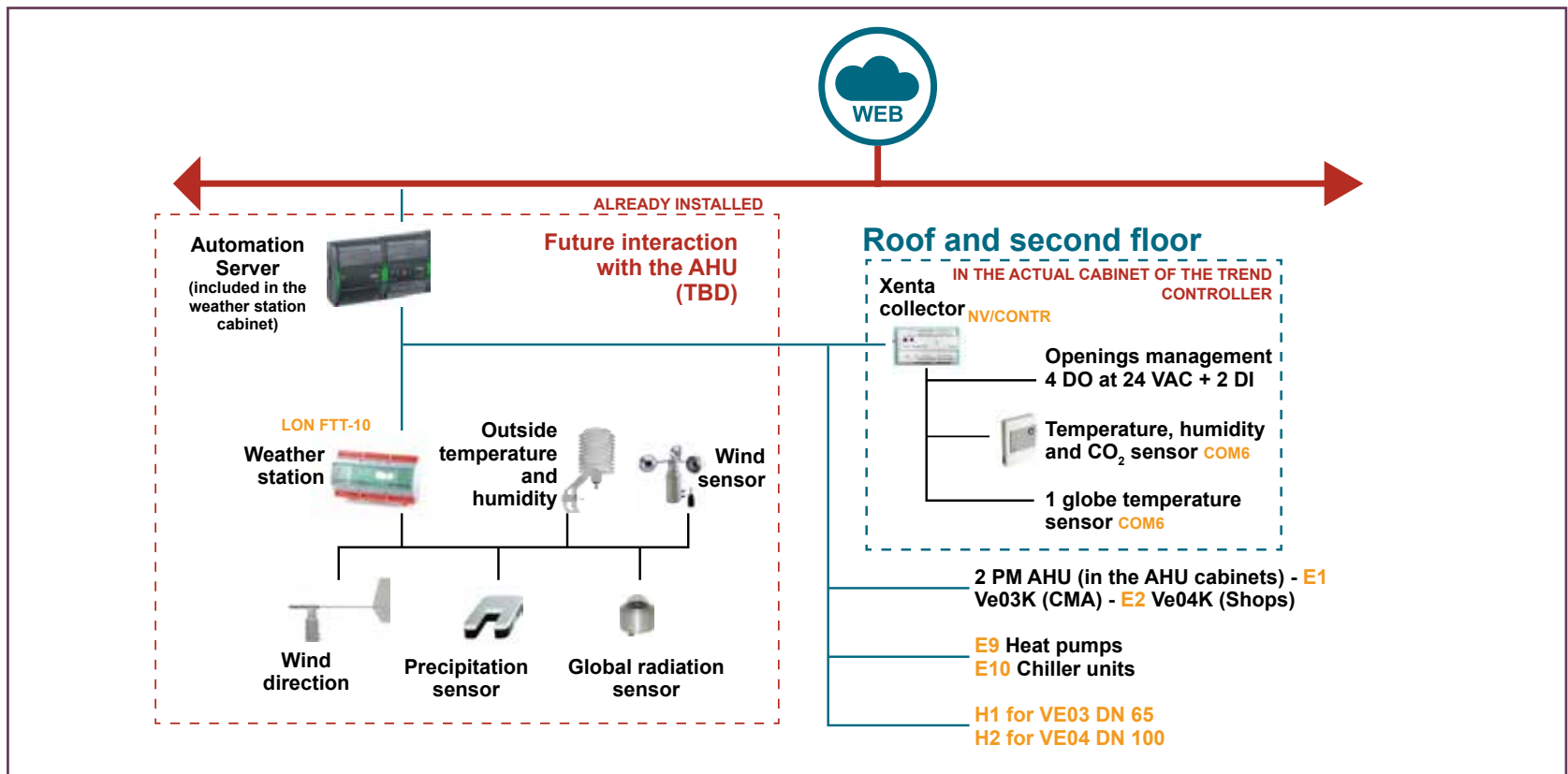
In the City Syd shopping centre of Trondheim, Norway, it was suitable to apply enhanced stack ventilation through the main atrium. The strategy combines the effect of opened sliding doors and existing skylight openings to enhance stack ventilation and ventilate/cool the common areas. To prevent cold draughts, skylight-window groups are controlled separately and the opening angle of the skylight windows is modulated according to the outdoor and indoor temperatures as measured by sensors distributed within the common areas.

The total electricity consumption for the common areas cooling and ventilation over the whole reference year is predicted to decrease by 11%. Simulation results also showed that, with the defined control strategy, natural ventilation is effective in providing the minimum required air change rates for 98% of its activation time.

**Figure 10.5 - City Syd demo case: skylights in the central atrium and the cafeteria located on the mezzanine below. Openable windows are present on both sides.** Source: EURAC.



**Figure 10.6 - iBEMS architecture for openings automation in the City Syd demo case.** Source: Schneider Electric Italia.



## REFERENCES

---

BCSC Retail leading property. (2014). Guidance note 68 - Shopping centre natural ventilation design. [Online] [http://research.bcsc.org.uk/sustainability/publication.asp?pub\\_id=459](http://research.bcsc.org.uk/sustainability/publication.asp?pub_id=459)

De Dear R., Brager G., Cooper D. (1998). Developing an adaptive model of thermal comfort and preference. RP-884 ASHRAE. [Online] <http://www.cbe.berkeley.edu/research/other-papers/de%20Dear%20-%20Brager%201998%20Developing%20an%20adaptive%20model%20of%20thermal%20comfort%20and%20preference.pdf>

EN ISO 7730: 2005 Ergonomics of the thermal environment -- Analytical determination and interpretation of thermal comfort using calculation of the PMV and PPD indices and local thermal comfort criteria.

Haase M., Stenerud Skeie K., Woods R., Mellegård S., Schlanbusch R. D. (2015). Typical functional patterns and socio-cultural context. [http://www.commonenergyproject.eu/uploads/deliverable/file/3/WP2\\_D2.3\\_20150131\\_P07\\_Typical\\_functional\\_patterns\\_and\\_socio\\_cultural\\_context\\_NotPrintable.pdf](http://www.commonenergyproject.eu/uploads/deliverable/file/3/WP2_D2.3_20150131_P07_Typical_functional_patterns_and_socio_cultural_context_NotPrintable.pdf)

Woods R., Mellgård S., Schlanbusch R. D., Stenerud Skeie K., Haase M. (2015). Shopping centres inefficiencies. [http://www.commonenergyproject.eu/uploads/deliverable/file/2/WP2\\_D2.2\\_20150130\\_P07\\_Shopping\\_malls\\_inefficiencies\\_NotPrintable.pdf](http://www.commonenergyproject.eu/uploads/deliverable/file/2/WP2_D2.2_20150130_P07_Shopping_malls_inefficiencies_NotPrintable.pdf)

WorldGBC. (2016). Health, Wellbeing and Productivity in Retail: the impact of green buildings on people and profit. WorldGBC's Better Places for People. [Online] <http://www.worldgbc.org/files/7114/5444/1490/FinalReport-Jan2016New.pdf>

EN 15251:2007 Indoor environmental input parameters for design and assessment of energy performance of buildings addressing indoor air quality, thermal environment, lighting and acoustics.



**Mercado del Val natural ventilation strategy.** Source: CommONEnergy.



← **coop** POLIZIA MUNICIPALE PARCHEGGIO PRIVATO ↑

**Common area, Modena Canaletto, Italy.** Source: CommONEnergy.

# 11.

## THERMAL ENVIRONMENT IN COMMON AREAS

Large shopping centres are based on a model of small individual stores connected by common areas. These zones represent a peculiar type of indoor environment that borrow characteristics from outdoor spaces and from traditional indoor environments resulting in a high variability of thermal condition. Since their function is to harmonize users' shopping experience within the shopping centre, connecting the different zones and shops, their use is not constant but affected by the high variability of people walking through. Observed users' activity is dynamic, even though the permanence period deeply differs depending on the motivation for visiting the shopping centre, creating very unstable and variable occupancy conditions.

At the moment, standard air conditioning systems operate to maintain constant indoor comfort conditions leading to high comfort level expectations among customers. The customers' experienced-indoor-temperatures are generally independent from the actual outdoor temperature conditions. Indoor air temperature set-points are based on guidelines intended for more traditional indoor environment, or set up based on the experience of the system manager. The variability in term of clothes worn by customers and their activity is not taken into consideration, sometimes resulting

in discomfort conditions throughout the year.

Considering their features, common areas may not require the same high level and close control as would indoor or fully-occupied areas; thus, a wider variation in conditions and interpretation of thermal comfort may be permitted creating the potential for more relaxed ranges of interior conditions than the retail stores adjacent to them. Considering that customers who feel comfortable will shop longer and spend more<sup>55</sup>, preventing discomfort conditions is essential for the shopping centres profit.

So far, no guidelines on thermal comfort have been identified that are specific to retail common areas. The definition of thermal comfort ranges

for general department store environment<sup>56</sup>, which are the basis for the definition of the air conditioning set-points, comes from a thermal comfort theory<sup>57</sup> which seems to not accurately predict the potential thermal discomfort for either naturally-ventilated environments or transitional spaces as shopping centre's common areas. Changing metabolic activity and users' adaptation is indeed not considered. To prevent thermal discomfort, a narrow control of thermal conditions inside these zones is usually operated.

Within *CommONEnergy*, the real customers' thermal comfort in shopping centres common areas was investigated.

**Figure 11.1 - Gallery of DonauZentrum shopping centre, Wien.** Source: EURAC.



<sup>55</sup> Coleman, P. (2006). *Shopping Environments: Evolution, Planning and Design*. Oxford, UK: Elsevier. <http://www.commonenergyproject.eu/>

<sup>56</sup> EN ISO 15251. (2008). *Indoor Environmental input parameters for design and assessment of energy performance of buildings addressing indoor air quality, thermal environment, lighting and acoustics*.

<sup>57</sup> Fanger, P. (1970). *Thermal Comfort*. Copenhagen: Danish Technical Press. <http://www.commonenergyproject.eu/>



Direct interviews with customers, combined with field measurement of the environmental parameters, were performed to define comfortable conditions: a number of at least 80% of people in comfort<sup>58-59</sup> can be reached up to an operative temperature<sup>60</sup> of 28°C<sup>61</sup>. This evidence opens room for a cooling set-point refinement that can potentially be modulated depending on outdoor climatic conditions and open possibilities to apply ventilative cooling strategies, still guarantying customer expectations and will.

The reduction of internal and solar gains in common areas can play a great role to reduce the radiant thermal effect which results in the possibilities of higher indoor air temperature, directly controlled though the HVAC systems.

By adopting these measures and considering less constrictive environmental conditions, however accepted and judged as comfortable by customers, energy managers can save energy and money of running costs. The benefits are increased by the fact that common areas already use more energy per unit area or volume than many other environments in the shopping centre.

Contrary to what could be expected, the study also revealed that the time spent inside a shopping centre has not a great effect on the way customers

perceive the thermal environment. Depending on their permanence period, no trends in the way they express their thermal sensation has been noticed.

The answers to the question *“How would you prefer the thermal environment?”*, (with respect of one’s experience at the interview point) has also disclosed how customers prefer “no change” in the thermal environment under different operative and indoor-outdoor temperature difference, which suggests a great adaptation to different thermal conditions. This aspect is probably due to the awareness that they cannot directly control the thermal environment, resulting in a higher tolerance in comparison with conventional indoor spaces.

The proposal of a better control of thermal conditions in common areas, taking into account the real sensation and comfort state of customers, is beneficial both for customers’ satisfaction (which correlates selling improvements) and energy savings for the shopping centre. Post-occupancy evaluation, with a combination of direct interview and environmental measurements, seems to be a powerful diagnosis instrument for shopping centres, which opens room to improve the thermal environment and energy management.



**THE REDUCTION OF INTERNAL AND SOLAR GAINS IN COMMON AREAS CAN PLAY A GREAT ROLE TO REDUCE THE RADIANT THERMAL EFFECT WHICH RESULTS IN THE POSSIBILITIES OF HIGHER INDOOR AIR TEMPERATURE, DIRECTLY CONTROLLED THOUGH THE HVAC SYSTEMS.**

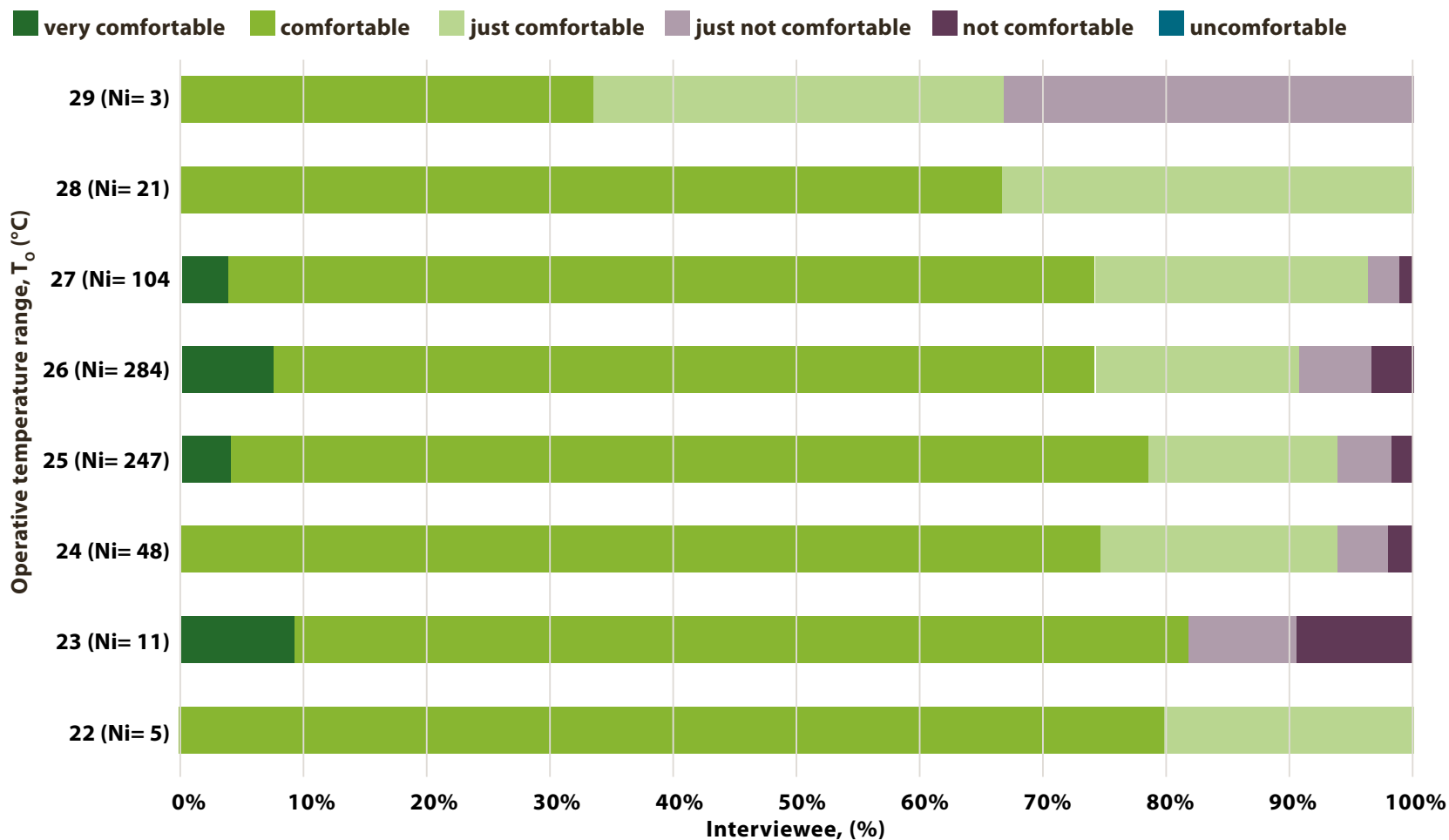
<sup>58</sup> EN ISO 15251. (2008). Indoor Environmental input parameters for design and assessment of energy performance of buildings addressing indoor air quality, thermal environment, lighting and acoustics.

<sup>59</sup> ASHRAE Standard 55. (2013). Thermal Environmental Conditions for Human Occupancy. Atlanta.

<sup>60</sup> The operative temperature represents the temperature experience by the costumers which is influenced by both their convective and radiant thermal exchange with the environment (EN ISO 7730, 2005).

<sup>61</sup> Belleri, A. (2017). Ventilative Cooling. EU FP7 CommONEnergy project (FP7-2013 grant agreement no 608678).

**Figure 11.2 - Distribution of customers' thermal comfort vote over different recorded operative temperature during the field campaign.** Source: EURAC



## REFERENCES

- Coleman, P. (2006). Shopping Environments: Evolution, Planning and Design. Oxford,UK: Elsevier. <http://www.commonenergyproject.eu/>
- EN ISO 15251. (2008). Indoor Environmental input parameters for design and assessment of energy performance of buildings addressing indoor air quality, thermal environment, lighting and acoustics.
- Fanger, P. (1970). Thermal Comfort. Copenhagen: Danish Technical Press. <http://www.commonenergyproject.eu/>
- ASHRAE Standard 55. (2013). Thermal Environmental Conditions for Human Occupancy. Atlanta.
- Belleri, A. (2017). Ventilative Cooling. EU FP7 CommONEnergy project (FP7-2013 grant agreement no 608678).
- EN ISO 7730. (2005). Ergonomics of the thermal environment – Analytical determination and interpretation of thermal comfort using calculation of PMV and PPD indices and local thermal comfort criteria.



**Common area, Modena Canaletto, Italy.** Source: CommONEnergy.



# 12.

## ACOUSTIC ENVIRONMENT

Renovation must not only enhance the envelope thermal features, but also the acoustic ones. In the same way, the indoor environment comfort must be enhanced not only from a thermal, but also from an acoustic point of view. The thermal-acoustic panels developed within the project incorporate two functionalities: acoustic absorption and thermal insulation.

Although there are no specific standards in this subject matter, there is a growing interest to acoustic in shopping centres since the echoing in common areas can create discomfort and unpleasant psychological effects. There are studies showing the impact on echoing for specific dome geometries, common areas, corridors layout for all typologies of shopping centres. The sounds of the environment have direct human influences: in particular, sound level (speech intelligibility) and Speech Transmission Index. It could especially be important for shopping

centres where the noise is emitted by the customers, shops or installation activity.

All studies highlighted the importance of sound-absorbing materials to correct discomfort. The good practice on those cases may be represented, and consider integrating once again new technologies, materials and acoustic diffusors. Sound-absorbing material may have a very wide surface to be effective and for this reason, during the retrofit, it is financially interesting to select thermal-insulating finishing material (which are indirectly requested by the EU Directive EPBD-2002/91/EC), showing at the same time a sound-absorbing property.

Few thermal-acoustic materials of this kind are available on the market and some of them seem not to be widely known by architects and designers.

Interviews with experts allowed finding the most relevant solutions for shopping centres with different interest for them:

- Proven track record for partings of shopping centres, thermal insulation and fire resistance interesting for top floor. Sound reduction in shopping centres' technical rooms, in conjunction with sound-absorption beneath, proven track record for commercial buildings;
- False ceilings or wall coverings, proven track record for commercial building;
- Those with a nice finishing with interest for top level shopping centres, high costs.

At the end, recommended levels of the acoustic may be referenced.



---

THERE IS A GROWING INTEREST TO ACOUSTIC IN SHOPPING CENTRES SINCE THE ECHOING IN COMMON AREAS CAN CREATE DISCOMFORT AND UNPLEASANT PSYCHOLOGICAL EFFECTS.

---



Light tubes in the Jens Hof shop, City Syd, Trondheim, Norway. Source: CommONEnergy.

# 13. LIGHTING

## 13.1 LIGHTING QUALITY

It is a challenge during lighting systems retrofitting to consider both the lighting quality and energy savings.

Both criteria can be defined at different levels, starting from passive but very useful measures like increased harvesting of daylight. The following list emerged from the analysis of inefficiencies on the project demo case buildings, showing typical and important planning issues and solutions. Many of these points are explained in more details in the following paragraphs 13.2 - 13.3 - 13.4, which describe all specific solutions carried out for the demo buildings as product and concept developments.

### LEVEL: DAYLIGHT HARVESTING

Daylight use should in general be increased by creating additional façade or roof openings. Natural light provides the best possible lighting quality, e.g. natural spectrum and time variability. A daylight coefficient between 5% and 10% is recommended. Energy savings by a reduced switch-on time of artificial light or reduced intensity of artificial light is only possible when dimmable light sources and luminaires, together with a suitable control system and sensors, are available. For shops, a study showed that people tend to stay longer in shops if daylight is available and the increased turnover is at least 19 times greater than the energy savings<sup>62</sup>. Great care must be put to develop a project-specific solution that avoids negative impacts like glare or threatening of merchandise (e.g. bleaching of clothes).

Visual and thermal quality in daylit areas should be increased, e.g. by reduction of uncomfortable direct sunlight or reduction of high luminance values (glare).

### LEVEL: LIGHT SOURCE

In a US study (2011)<sup>63</sup> on retail facilities, lighting accounted for 42% of energy consumption (not considering impact from cooling).

The most obvious factor for a high energy demand of lighting is the use of inefficient lamps, e.g. Compact fluorescent lamps CFL or halogen lamps. While halogen or CFL lamps show a luminous efficiency in the range 20 to 70 lm/W, LEDs currently reach up to 140 lm/W.

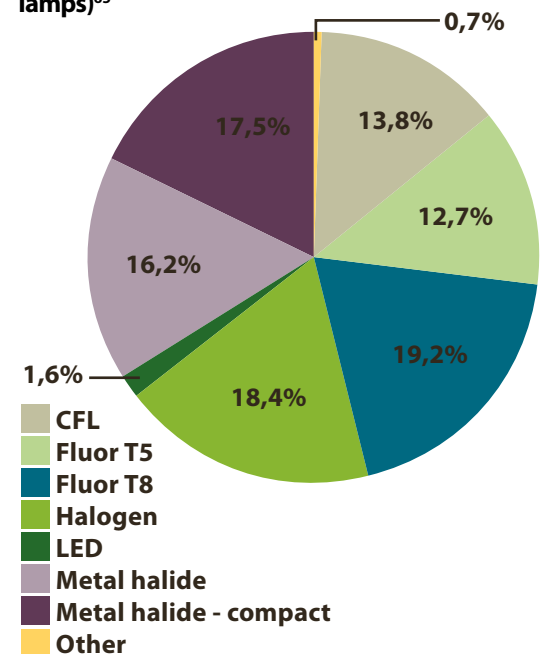
A study by the Building Research Establishment BRE in 2011<sup>64</sup> revealed a proportion of 32% for CFL and halogen lamps in UK shopping centres while energy-efficient LEDs reach a proportion of only 1,6% (see Figure 13.1).

Beneath their good energy-efficient behaviour, LEDs also contribute to an improvement of lighting quality:

- Many different light spectra (colour temperature) are available. Different milieus, e.g. for biodynamic light, are possible.
- LEDs are small so that different LEDs (e.g. with different colour temperatures) can be integrated in one luminaire. Luminaire design based on LEDs has a great degree of freedom, e.g. for miniaturization.

- LEDs are dimmable, which is crucial for a high quality of control, e.g. exact addition of artificial light to available daylight.

**Figure 13.1 - Estimate of proportion of lamps in UK shopping centres (related to number of lamps)<sup>65</sup>**



<sup>62</sup> Heschong L. (2003). Daylight and Retail Sales.

<sup>63</sup> Illuminating Engineering Society. (2011). The Lighting Handbook. 10th ed. New York.

<sup>64</sup> Ticleanu Cosmic C., Littlefair Paul J., H. G. J. (2013). The essential guide to retail lighting. Garston, Watford: BRE Press.

<sup>65</sup> Ticleanu Cosmic C., Littlefair Paul J., H. G. J. (2013). The essential guide to retail lighting. Garston, Watford: BRE Press.

## LEVEL: LUMINAIRES

High-quality luminaires that are able to satisfy the specific requirements of the illumination task with a high-light-output ratio not smaller than 0,8<sup>66</sup> should be applied. Good quality can be achieved e.g. by using good reflector materials and first-class reflector technology, e.g. with freeform micro-faceted technology but also by choosing an efficient driver. It is also important to apply luminaires that illuminate only the area of interest by a tailored-luminous-intensity distribution based on a lighting concept for the space. Attention should be drawn to the issues glare control, reduction of light pressure, brilliant appearance in sale areas and an adequate colour rendering index CRI:

- For sale areas, CRI >90
- For centre areas, CRI >80

For examples of a dedicated luminaire choice (in this case: luminaire development), see Chapter 13.3.

## LEVEL: OVERALL CONCEPTS AND CONTROL

In smaller shops, we often observed a lack of clear lighting concept. Spot lighting luminaires are used all over the shop, resulting in high overall intensities. In a perception study<sup>67-68</sup>, a zonal lighting concept with few zones of high intensities and a lower general illumination level (while maintaining the same brightness perception) saves energy but also introduces opportunities to guide customers through the shop and to the merchandise (see Chapter 13.2).

The lighting concept could also include biodynamic lighting that supports the human circadian rhythm by a change of light colour. As people are satisfied with lower intensities and warmer light colours in the evening, this approach also enables energy savings.

Special attention should also be drawn to appropriate room surfaces. Reflections from surfaces define the room efficiency and play an important role as a white floor (reflectivity about

80%) compared to a deep red floor (reflectivity < 10%) accounts for a reduction in necessary wattage of 50%. A high gloss level of the floor surface may induce virtual mapping of luminaires (with high luminance concentration), causing a disturbed visual perception and misguided attention.

Only an associated control system can implement zonal concepts or different milieus, e.g. the warm-white evening milieu. Lumen depreciation of luminaires can be corrected by a Constant Light Output (CLO) control achieving significant energy savings during its life time. And it is important to monitor and visualize key performance indicators for lighting (quality and energy), to inform the shop owner about the "green" performance of the shop (for details see Chapter 13.4).

The following chapters show exemplary solutions developed for important typical areas of shopping centres on the basis of specific demo case buildings.

<sup>66</sup> Pohl W. (2010). Technology forecast in Lighting regarding Energy Efficiency. Sixth International Conference. Improving Energy Efficiency in Commercial Buildings IEECB'10.

<sup>67</sup> Ampenberger A., Staggl S., and Pohl W. (2017). Visual, Emotional and energy effects of a new lighting concept. <http://commonenergyproject.eu/resources/deliverables>

<sup>68</sup> Ampenberger A., Staggl S., and Pohl W. (2016). Energy efficiency and perceived brightness in retail. Licht 2016. Deutsche Lichttechnische Gesellschaft. KIT Scientific Publishing.

## 13.2 DAYLIGHTING STRATEGIES

Room illumination by harvesting daylight should always be the first choice, due to a valuable connection to the natural environment with its ideal light spectrum and a high energy-saving potential. Thus, we recommend exploiting daylight more often in shops and centres as currently done under consideration of these advices.

### A. DAYLIGHT IN CENTRE CORRIDORS

Often, corridors do not have any daylight openings, only entrance situations or larger atria supply daylight to the building. To improve this situation, smaller daylight openings (few square meters), in distances of 20-50 m, could be added in the roof of upper storeys. This intervention creates spaces with a high-quality daylight connection that structures corridors and are ideal to establishing recreation or event areas.

### B. DAYLIGHT IN LARGE CENTRE ATRIA

Large atria areas (they define exceptional spaces for the stay, orientation etc.) often suffer from over-exposure to daylight, resulting in a disturbed stable visual perception<sup>69</sup>. Adjacent stores sometimes are involved as well, whereas sensitive merchandise could be affected negatively or customers in the shop might have to cope with glare. Most often, simple sun-shading screens are applied, but they have disadvantages like disturbing the view to outside or can even cause the need for artificial lighting although daylight is available.

A promising solution is to implement an adjustable spatial array of daylight systems with specific selective properties to influence the effective opening area and its transmission characteristic, e.g. regarding redirection of rays. Hereby, daylight planning can react to specific requirements of the atrium relating to geographic location and spatial needs in the building (e.g. block direct radiation from specific areas).

For a medium-sized atrium (19m x 9m) in CitySyd (the Trondheim demo building), such a modular

roof system was developed: it offers in the central area a bearing structure which can be equipped with a mixture of different elements (see Figure 13 2 and Figure 13 3). These elements were identified as potentially interesting for atria in general:

- Sun Shading Grid: Blocks direct sun, but is permeable for the diffuse sky;
- Sun Harvesting Grid: The grid is orientated towards the sun path, collects direct sun rays and redirects them in the depth of the atrium towards the floor. This results in an ideal illumination of the actual atrium space over the whole height. Adjacent areas, e.g. shops that cannot tolerate direct sunlight are protected (to avoid destruction of merchandise or disturbance of customers' visual perception);
- Solar Protection Grid: This element carries a mirror operating as a reflector for a projector/mirror system as artificial lighting solution in the atrium, a very common and handy solution. The element itself is opaque and protects from solar radiation. On the outer surface, it could be equipped with a photovoltaic system for energy generation.

All three systems are static systems, they consume no operational energy and need no maintenance.

The overall impression of the modular system (with different systems and different materials) avoids a monotonous and too technical impression, which was evaluated as important for the customer.



**ROOM ILLUMINATION BY HARVESTING DAYLIGHT SHOULD ALWAYS BE THE FIRST CHOICE, DUE TO A VALUABLE CONNECTION TO THE NATURAL ENVIRONMENT WITH ITS IDEAL LIGHT SPECTRUM AND A HIGH ENERGY-SAVING POTENTIAL.**

<sup>69</sup> Witting W. (2014). Licht. Sehen. Gestalten. Basel: Birkhäuser Verlag.



**Figure 13.2 - Project-specific combinations and arrangement of sun shading, sun harvesting and sun protection functionalities define the integral daylighting system.** Source: Bartenbach.

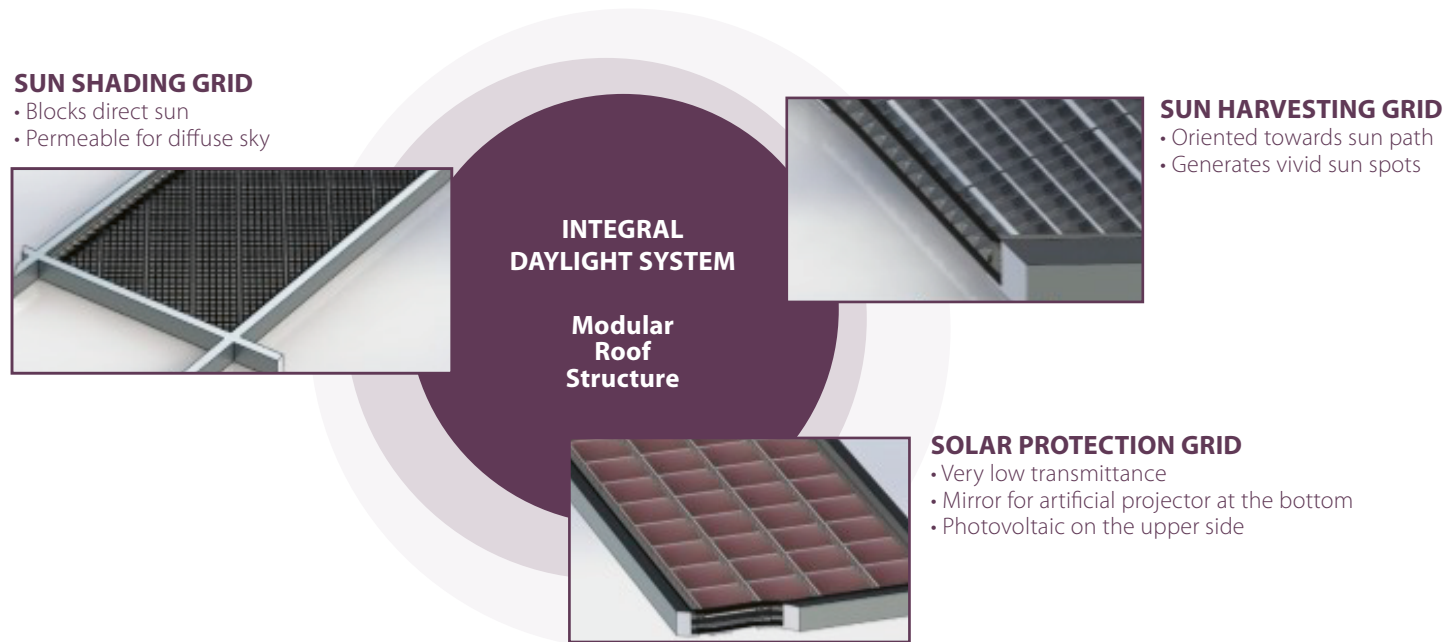


Figure 13.3 shows the sun-harvesting grid and its application in the centre fields of the sloped atrium roof in CitySyd shopping centre, Trondheim. Initially, the atrium – and as a result the adjacent restaurant – was often directly hit by sun-light at low sun angles (due to orientation of East-South-East and due to a high latitude of 63°23') causing uncomfortable glare. By applying the sun-harvesting system (which was specifically

developed for this geographic location and room situation) critical sun-rays are redirected to the floor while the adjacent restaurant is prevented from glare by the harvesting grid (see Figure 13.4). It generates natural and vivid sun spots on the floor. The lateral fields of the roof are equipped with a movable, motorised sun shading screen. At situations with high solar radiation, the screens will close automatically to prevent the atrium from

overheating and from too high illuminance values. In these conditions, a sufficient amount of light is still provided by the sun-harvesting grid in the centre of the roof. Due to the modular concept and a carefully planned combination of elements (type, number, position), the atrium will be lit by an optimum light quantity and quality without glare at sensitive areas and without thermal overheating.

**Figure 13.3. Sun-harvesting grid.** Source: Bartenbach.

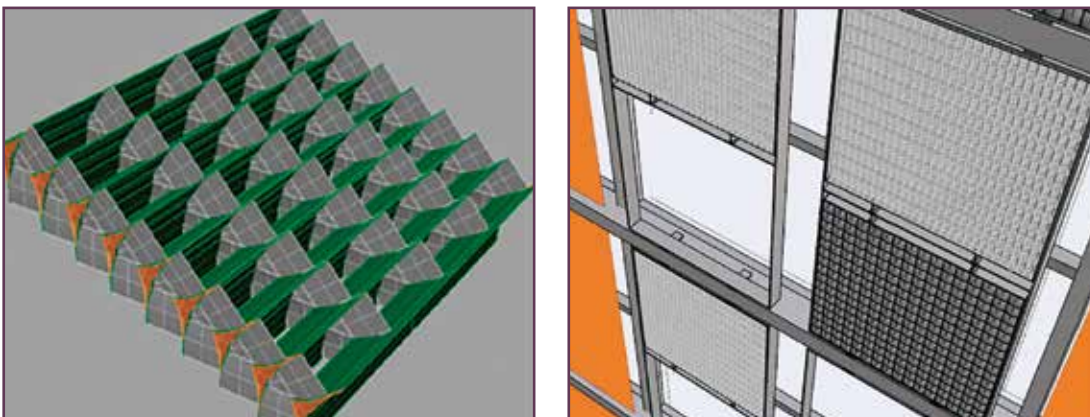
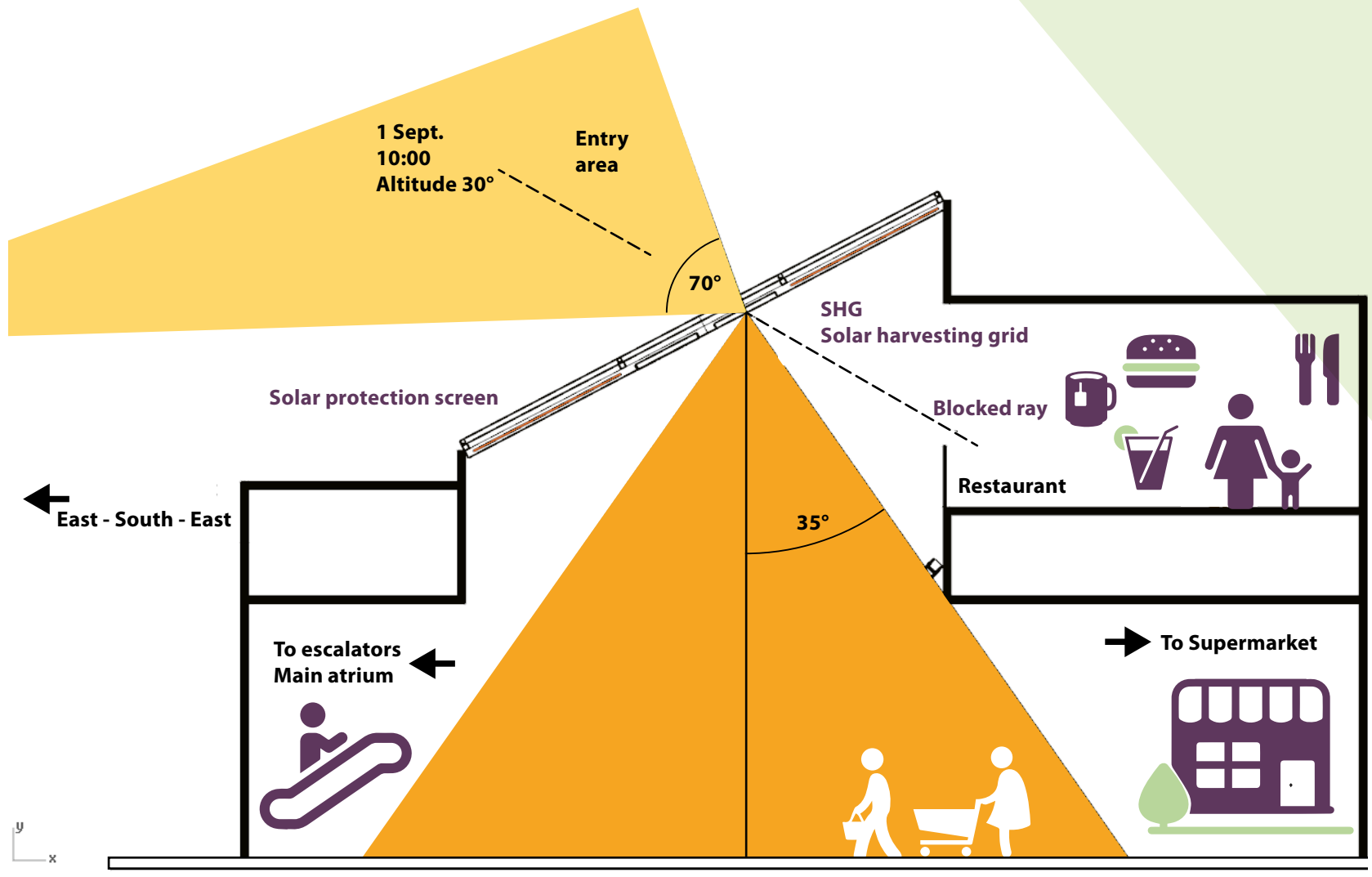


Figure 13.4 - Redirection of sunlight to the floor, prevention of glare from restaurant. Source: Bartenbach.



### C. DAYLIGHT IN SHOPS

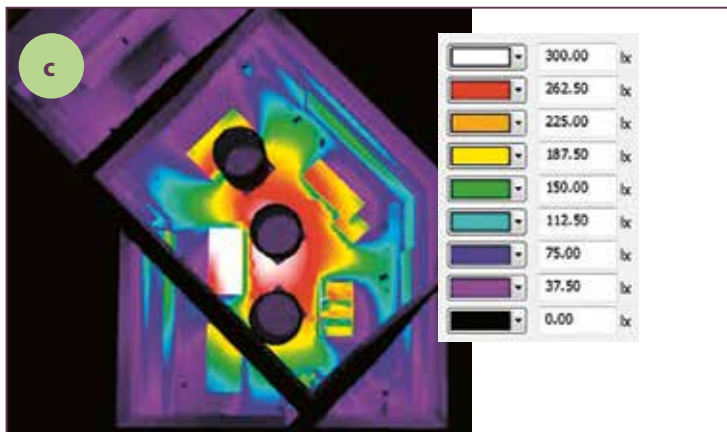
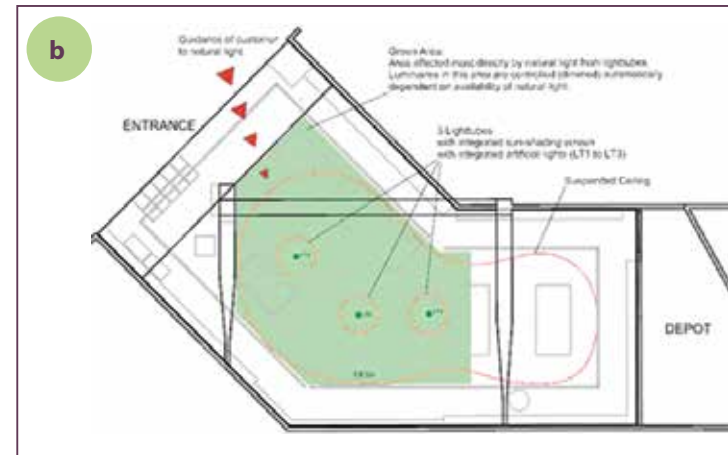
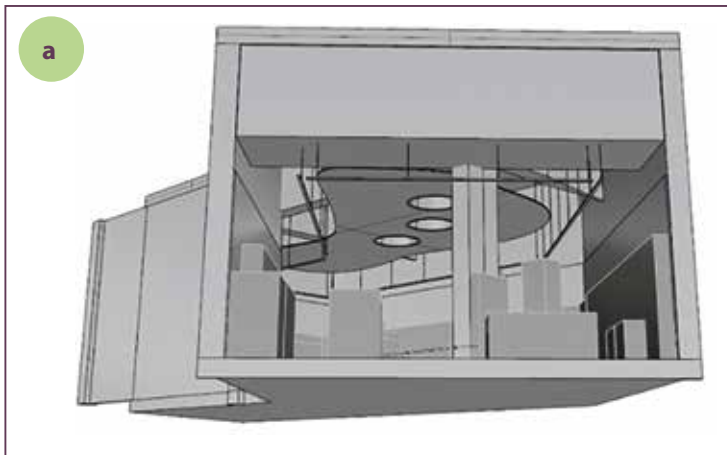
Harvesting of daylight in shops, e.g. for illumination of circulation areas or for specific staging of merchandise, will improve the room and stay quality, can support circadian rhythm of humans and connects to the outside environment with improvements in well-being.

Figure 13.5 shows the conceptual design for daylighting a smaller shop in the City Syd shopping centre in Trondheim with light tubes. The shop was formerly without natural daylight but could, in principle, create access to the outside via its roof. The light tube bridges over the great room height and

transports daylight with high efficiency through roof installation structures down to the shop. For design reasons, the light tube was integrated into a suspended ceiling which increases with its bright surface the reflection grades and room light-distribution efficiency (compared to the formerly black raw ceiling). Energy savings can be achieved while using a dimmable technology, sensors and a control system for those luminaires which directly benefit from daylight (this area is displayed in green colour in Figure 13.5 b). Positive impact on the turnover can be expected due to improved space quality and natural colours for merchandise

examination (compare also with the results of Heschong (2003)<sup>70</sup>). To limit an excessive direct sun light, the light tubes are equipped with a movable sun-screen, controlled by an outside illuminance sensor. If there is no sufficient daylight, artificial light can be added to supplement (or completely replace) daylight via the distribution body of the light tube thanks to an operation of 24 reflectors at the upper rim of the tube.

**Figure 13.5 - (a) Rendering of conceptual daylighting design with light tubes. (b) Floor plan with position of the 3 light tubes. Green area: Area that is affected by daylight, artificial light in this area is controlled in dependence of available daylight. (c) Daylight simulation of illuminance values for overcast sky (10.000 lx outside). (d) Implementation of light tubes and suspended ceiling in a shop of City Syd shopping centre in Trondheim.** Source: SINTEF and Bartenbach.



<sup>70</sup> Heschong L. (2003). Daylight and Retail Sales.

### 13.3 EFFICIENT LIGHTING TECHNOLOGIES

The medium-sized atrium in City Syd was initially equipped with suspended luminaires with a low lamp and luminaire efficacy. The roof itself at night appeared dark and not very attractive.

Here, we proposed a projector/mirror system as shown in Figure 13.6. A LED-projector luminaire is situated on a lateral wall with its beam orientated towards mirrors. These mirrors are mounted as part of the modular roof and reflect the light back to the floor. The illuminated mirrors slightly brighten up the dark roof and, this way, pleasantly define the upper end of the atrium space. The mirror can also function as an energy generator when equipped on the outside face with a photovoltaic system. Projectors can be maintained easily as they

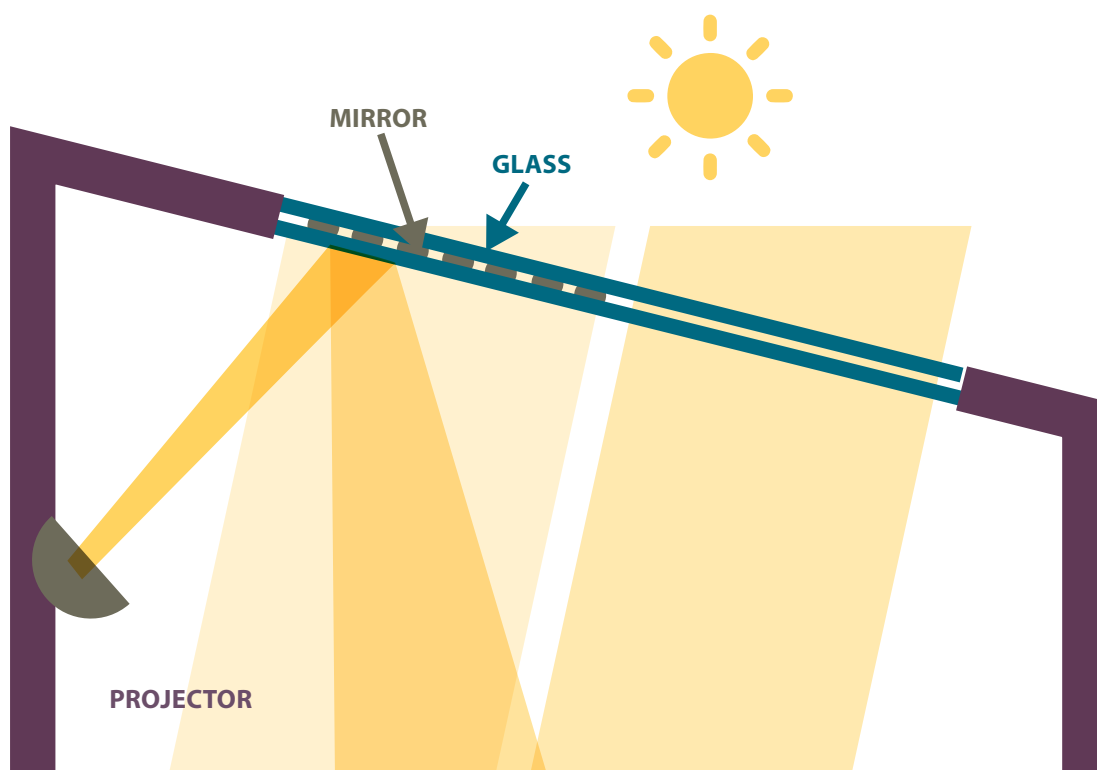
are mounted on the side (and not in the height of the gallery glass roof as it was for the initial lighting system). A daylight-sensitive control algorithm prevents that artificial lights are active while sufficient daylight is available.

Older projector/mirror systems were built with parabolic reflectors and cut-off rings resulting in a low efficiency. The projector applied now uses a hybrid principle that combines a multi-faceted reflector with a glass lens for a very narrow beam angle and high luminaire efficiency. Luminaire efficiency can be improved from around 35% for conventional projectors to 80% for this hybrid LED-spot projector (see Figure 13.7).

In the shops, we found unreasonable high and unpleasant illuminance intensities as a major problem. Often these high intensities were applied without a clear concept to all areas of the shop.

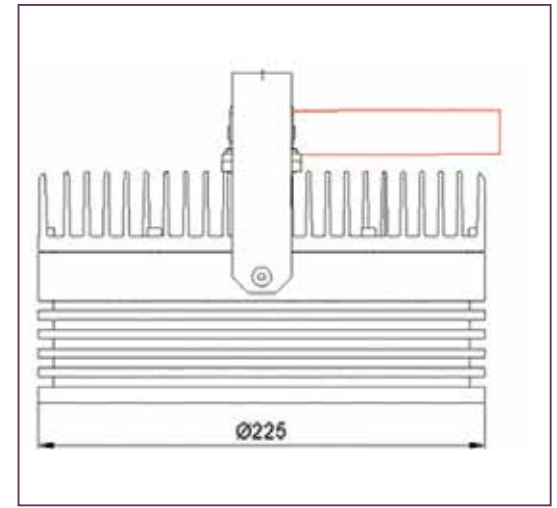
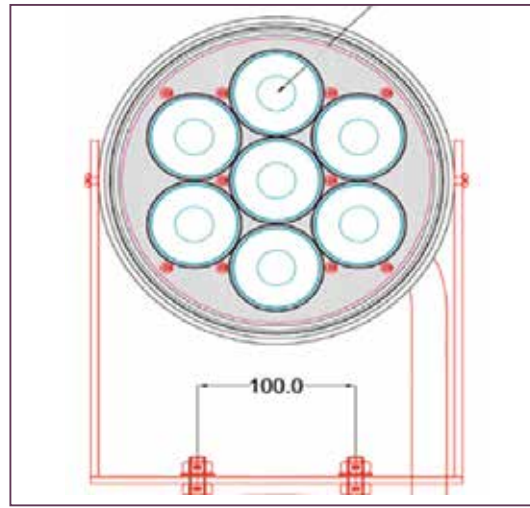
We developed the idea that a zonal concept with reduced overall intensities but clear zonal accents would make the space more interesting, could guide customers through the shop and could also reduce the energy demand. A parameter to evaluate such a concept is the perceived brightness, e.g. experienced from an observer while looking into the sale space from a defined position.

**Figure 13.6 - Function scheme of the projector-/mirror system.** Source: Bartenbach.



THE ILLUMINATED MIRRORS SLIGHTLY BRIGHTEN UP THE DARK ROOF AND, THIS WAY, PLEASANTLY DEFINE THE UPPER END OF THE ATRIUM SPACE.

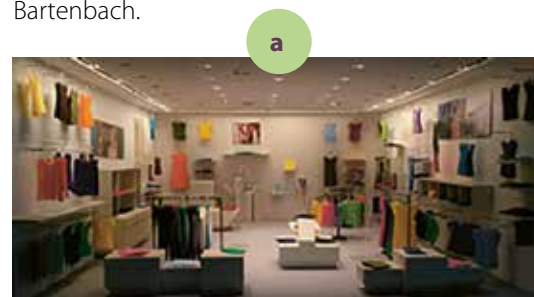
**Figure 13.7 - Photo and technical drawing of the projector luminaire.** Source: Product photos and drawings from DURLUM.



Research work revealed that people tend to judge the brightness of a space especially by looking at the wall<sup>71</sup> and that perceived brightness is a complex phenomenon, that differs from measured “objective” brightness as many additional information like illuminance distribution or contrasts (of intensity and/or colour temperature) are recorded and rated by the human sub-consciousness<sup>72</sup>.

To consider these correlations, we conducted a perception study with 40 human subjects to perceived brightness of a retail space. All participants were looking into a 1:10 model and compared different lighting scenes regarding the perceived brightness (shown in Figure 13.8). A strongly spatial-zonal light-distribution with a 30%-reduced overall lighting intensity was rated as similarly bright to homogeneous light scenarios with full luminous flux. Only few wall parts were illuminated with high illuminances while large fractions of the wall surface and also the space itself largely had lower illuminance values (see Figure 13.8).

**Figure 13.8 - 1:10 models for the perception study: (a) Homogeneous light distribution, (b) Zonal light distribution.** Source: Bartenbach.



**RESEARCH WORK  
REVEALED THAT  
PEOPLE TEND  
TO JUDGE THE  
BRIGHTNESS  
OF A SPACE  
ESPECIALLY BY  
LOOKING AT THE  
WALL.**

<sup>71</sup> Ticleanu Cosmic C., Littlefair Paul J., H. G. J. (2013). The essential guide to retail lighting. Garston, Watford: BRE Press.

<sup>72</sup> Cuttle, C. (2015). Lighting Design - a perception-based approach. London: Routledge.



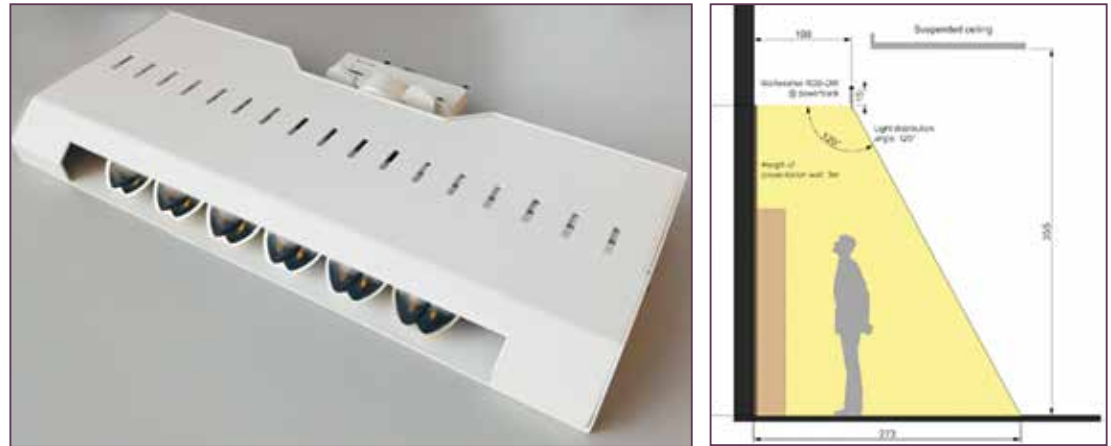
WALLS PLAY A MAJOR ROLE AS SALES AREAS IN SMALLER SHOPS AND THEY ARE IMPORTANT FOR A PERCEIVED BRIGHTNESS IMPRESSION.

Walls play a major role as sales areas in smaller shops and they are important for a perceived brightness impression. That is why we developed a retail wallwasher luminaire for this application. The retail wallwasher luminaire is a special development for shops with a light distribution not only on the wall but with an extended beam angle that also illuminates the area in front of the wall. Customers can take the merchandise out of the wall shelf and still have sufficient light for examination and decision-taking (see Figure 13.9). This way, the beam angle is precisely orientated towards the useful area and light is not wasted.

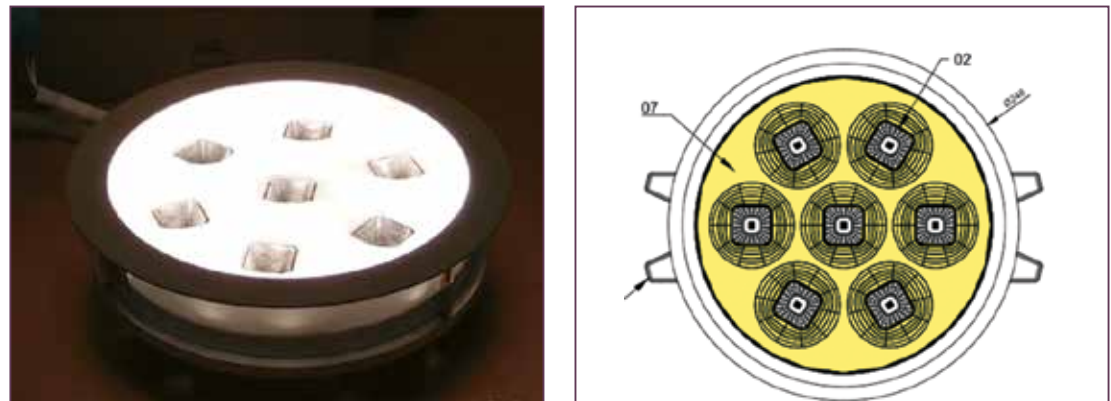
The uniform light-distribution of the wallwasher luminaire illuminates the merchandise in a large area in a very homogeneous manner compared to conventional spots with their very irregular spot-like illuminance distribution. Due to their exact orientation towards the wall together with their perfect longitudinal glare control, the glare probability is reduced considerably.

Another very innovative product development was done for the common centre area where downlights are frequently used, often with low-efficacy compact fluorescent lamps. The

**Figure 13.9 - Retail Wallwasher Luminaire.** Source (a) Product photo from Durlum, (b). Source: Bartenbach.



**Figure 13.10 - GRL luminaire.** Source: product photo and drawing from DURLUM



newly-developed GRL luminaire (General Retail Lighting)<sup>73</sup> combines downlights with a highly-efficient and perfect cut-off reflector technology with a diffuse back-lit area for greater vertical illuminances supporting better recognizability of people and objects. This luminaire integrates these two functions which are normally found in two separate luminaires very often in centres: Functional Downlight and Diffuse Light Field. It consists of an array of 7 LED micro downlights which provides functional light for the visual task and a planar-diffuse circular area, which is back-lit by LEDs (see Figure 13.10).

The back-lit area contributes to the reduction of glare and light pressure – often generated by the strong singular downlights – creates atmosphere, gives orientation and guidance while structuring corridors by adding visible luminances on the ceiling and giving the opportunity to support a corporate identity with coloured-back-lit areas (coloured light-source or coloured covering).

<sup>73</sup> [http://commonenergyproject.eu/uploads/biblio/document/file/1427/FLYER\\_07\\_GRL\\_FINAL.pdf](http://commonenergyproject.eu/uploads/biblio/document/file/1427/FLYER_07_GRL_FINAL.pdf)

Not only luminaires but also lighting concepts can strongly enhance energy-efficiency. A suggested overall superior concept is to create a common adaption and illuminance level in the whole shopping centre. Centre and all shops should be aligned to a reasonable illuminance intensity level to establish a common visual adaptation level and to prevent rivalry by using higher illuminance level than neighbours.

It is recommended that the centre management acts as catalyst and knowledge-carrier for information, motivation and integration of tenants into energy-efficient and valuable lighting solutions. New lighting concepts should be promoted by them, supported e.g. by suggestion of turn-key-ready and flexible solutions (see next chapter Lighting management) and encouraged e.g. by incentives. Such sustainable concepts

should be conceived as advertisement for the shopping centre. Overall concepts, e.g. alignment of adaption and illuminance levels of shops and common centre areas must be implemented and operated by the centre management and their iBEMS with connection to the local shop lighting and energy management system.

## 13.4 LIGHTING MANAGEMENT

Lighting planning for small shops is often neglected, bigger shops sometimes profit from individual planning but mostly without adequate consideration of energy conservation aspects. In addition, energy savings can often only be reached with a suitable control. Because of that, we developed the idea of the so-called “Green Lighting Box” which offers a turn-key ready control solution for shops that implements high-quality lighting scenes for retail applications, energy-saving strategies and monitoring possibilities.

This local solution for shop-lighting control consists of a local control unit, a local shop control panel (screen and touch panel) and DALI gateways for connection to luminaire driver. It can control dynamic shop-lighting scenes (schedules, sensor-controlled operation, e.g. daylight-dependent artificial lighting control) and provides pre-defined energy-efficient but still flexible lighting control algorithms. It is also able to monitor energy demand at different levels (shop/luminaire group/luminaire) by graphical display of key parameters, hereby providing valuable shop-lighting performance information to the shop operator. A connection to the central iBEMS of the shopping

centre is possible, e.g. to transfer certain energy monitoring parameters or even to receive superior control rules from the centre management, e.g. peak-load management or alignment of illuminance level for a uniform adaptation level.

All lighting solutions should establish dynamic human-centric lighting. In shopping centres, customers and shop assistants usually stay for a longer time in a quite hermetically-closed and non-natural environment. Long-time exposure to artificial light with its constant and artificial character does not fit well to the needs of the human circadian (and ultradian) rhythm which is orientated at the day/night-sequence and strongly depend on light as a trigger. Unfortunately, in shopping centres with large areas without daylight access, visitors and workers usually spend many hours in this situation.

To improve this situation, dynamic light that is orientated at the daytime/night-time period is considered highly-relevant for shopping centres with a positive biological impact (see DIN SPEC 67600<sup>74</sup>). Depending on actual sunrise and sunset times (weekly changing schedules), we implemented such a change in light milieu accordingly to the day/night change.

Daytime mode applies a neutral light colour temperature of 4000 K with a higher intensity

up to 500 lx (300 lx mean) horizontally, whereas the night-time mode applies a warm-white light colour temperature of 2700 K with a reduced mean intensity of 200 lx vertically in the common centre area (see Figure 13.11).

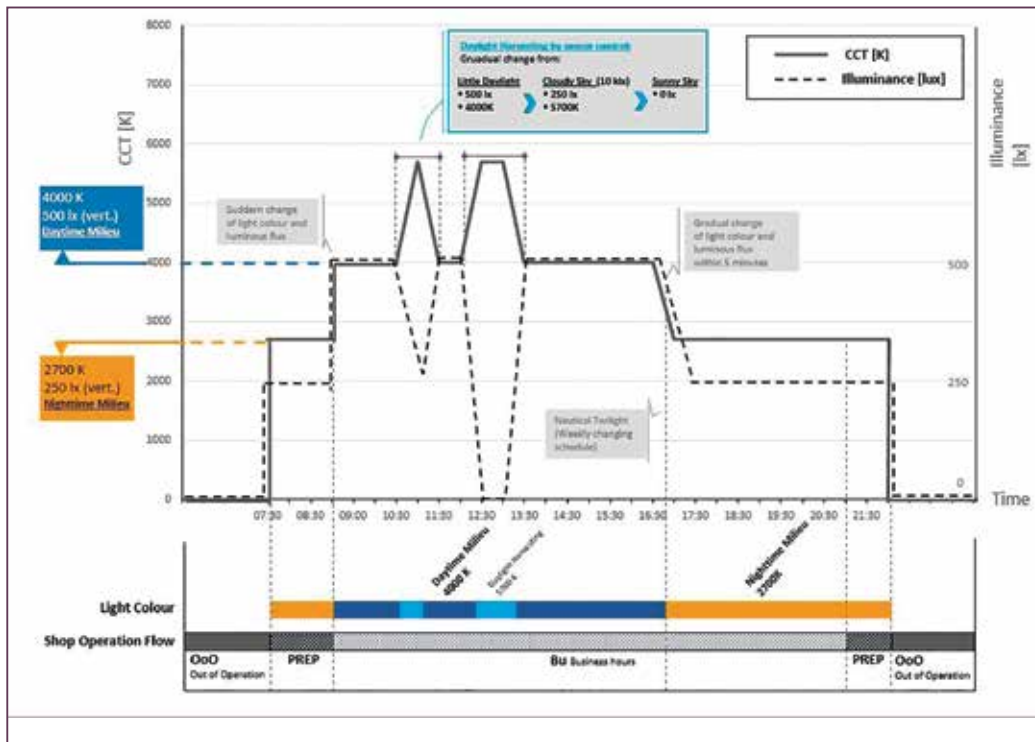
We applied predefined typical lighting periods for retail by using control time schedules. In the early morning and late evening, when the employees have already arrived to prepare shops but shops are not yet opened for public, we reduced the lighting intensity and changed the colour temperature to warm-white. In the evening, when the shopping centre is out of operation, the lights will be turned off automatically in shops and in the centre.



LIGHTING PLANNING FOR SMALL SHOPS IS OFTEN NEGLECTED, BIGGER SHOPS SOMETIMES PROFIT FROM INDIVIDUAL PLANNING.

<sup>74</sup> DIN SPEC 67600. (2013). Biologically effective illumination.

**Figure 13.11 - Visualisation of daily control sequence for application of human centric lighting (change from 2700 K to 4000 K colour temperature) and daylight-sensitive control (change to 5700 K colour temperature) at shops.** Source: Bartenbach.



All control algorithms for luminaires include a luminous flux compensation of LED as their luminous flux depreciates over life time. At the end of life time, the luminous flux has to satisfy the predefined lighting level (design value). Without a suitable control mechanism, the LED would have a too high luminous flux at the beginning of the lifetime. Constant Light Output control CLO adjusts luminous flux accordingly over lifetime to avoid excessive light and to save energy.

## REFERENCES

- Heschong L. (2003). Daylight and Retail Sales.
- Illuminating Engineering Society. (2011). The Lighting Handbook, 10th ed. New York.
- Ticleanu Cosmic C., Littlefair Paul J., H. G. J. (2013). The essential guide to retail lighting. Garston, Watford: BRE Press.
- Pohl W. (2010). Technology forecast in Lighting regarding Energy Efficiency. Sixth International Conference. Improving Energy Efficiency in Commercial Buildings IECEB'10.
- Ampenberger A., Staggl S., and Pohl W. (2017). Visual, Emotional and energy effects of a new lighting concept. <http://commonenergyproject.eu/resources/deliverables>
- Ampenberger A., Staggl S., and Pohl W. (2016). Energy efficiency and perceived brightness in retail in Licht 2016. Deutsche Lichttechnische Gesellschaft. KIT Scientific Publishing.
- Witting W. (2014). Licht. Sehen. Gestalten. Basel: Birkhäuser Verlag.
- Cuttle C. (2015). Lighting Design - a perception-based approach. London: Routledge.
- DIN SPEC 67600. (2013). Biologically effective illumination.





Refrigeration cabinets and ventilation applied in Modena Canaletto, Italy. Source: CommONEnergy.

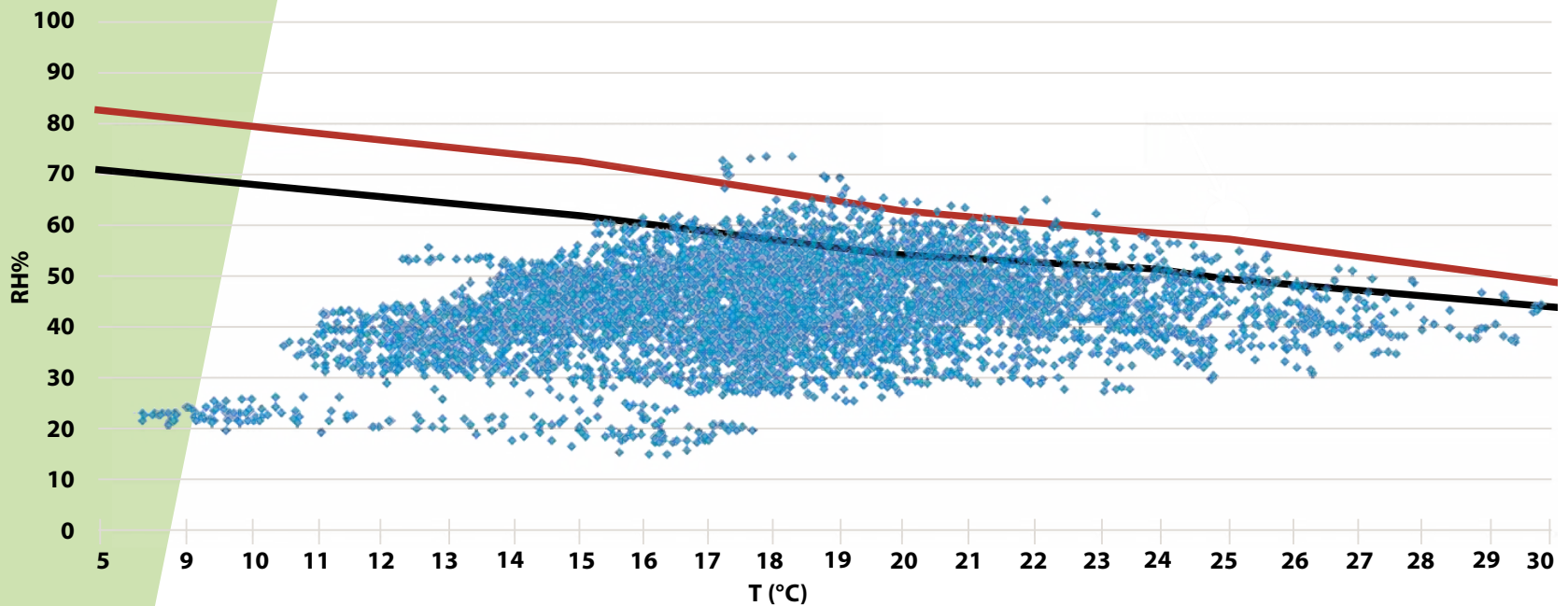
# 14.

## OPTIMIZATION OF REFRIGERATION CABINETS AREA LAYOUT AND TECHNOLOGIES

### 14.1 ENERGY EFFICIENT REFRIGERATION CABINETS

Energy performance of refrigerated display cabinets must be averaged over time to represent their yearly ecological and economic impact. Off-design conditions account for most of the time, due to ambient temperature and humidity variable in time and space. Opening rate, food loading and light dimming can also vary a lot from one cabinet to the other and influence the real thermal loads.

**Figure 14.1 - Statistical distribution of thermo-hygrometric conditions in stores in north Europe.**



By using modern control equipment, adaptation to store condition can be achieved inside the cabinets with two technologies: (a) Water loop and (b) Variable speed fans.

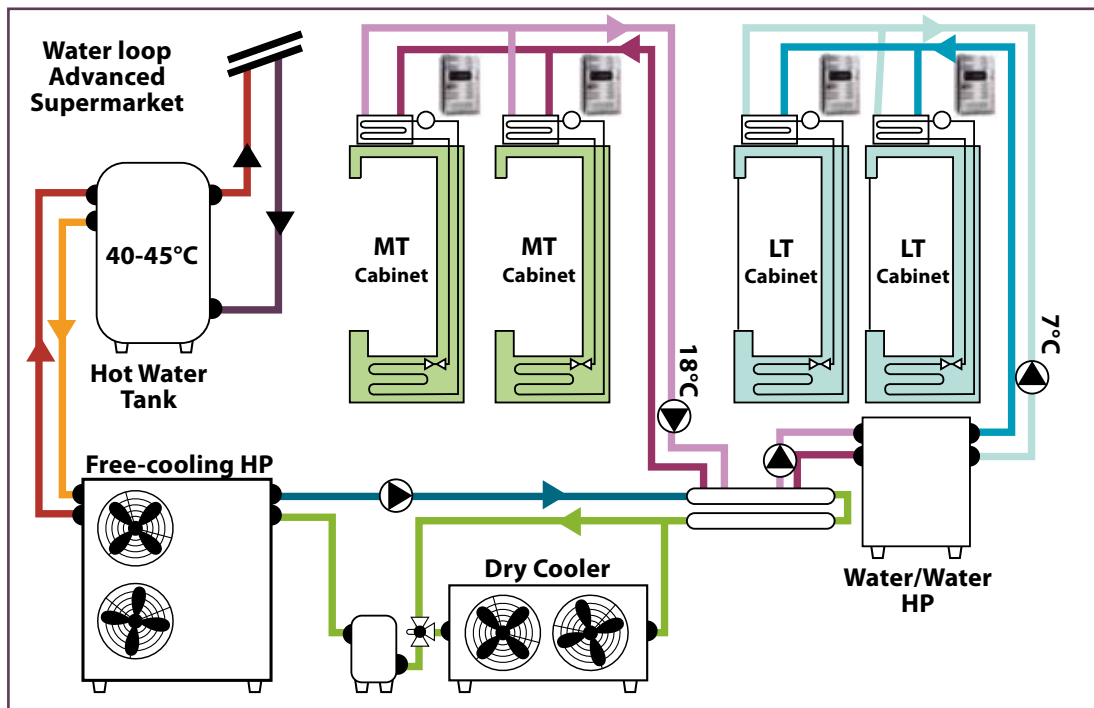


**THE KEY  
FEATURE OF  
THE CONCEPT  
IS THE  
INCLUSION OF  
A VARIABLE  
SPEED  
COMPRESSOR  
FOR EACH BOX.**

## A. WATER LOOP

The condensation heat of each cabinet is rejected to a water loop through a refrigerant/water heat exchanger. The total heat collected from cabinets is rejected to the environment by a dry cooler, using free cooling for most of the year. Adding a heat-pump in the plant, easy energy recovery and conversion towards HVAC is then possible, thus maximizing the use of consumed energy for each cabinet.

**Figure 14.2 - Water loop for distributed refrigeration system.** Source: EPTA.



The key feature of the concept is the inclusion of a variable speed compressor for each box. Like this, each single cabinet with its specific load is free to adapt to the effective need, running with the highest evaporation temperature possible and continuously adapting to the effective actual load.

In Table 14.1, a comparison of the average winter-evaporating temperature in a field test comparison, both for positive and negative refrigeration, water loop against two different level of Direct Expansion plant.

**Table 14.1 - Evaporating temperature with variable speed compressor water loop and Direct Expansion plants.** Source: EPTA.

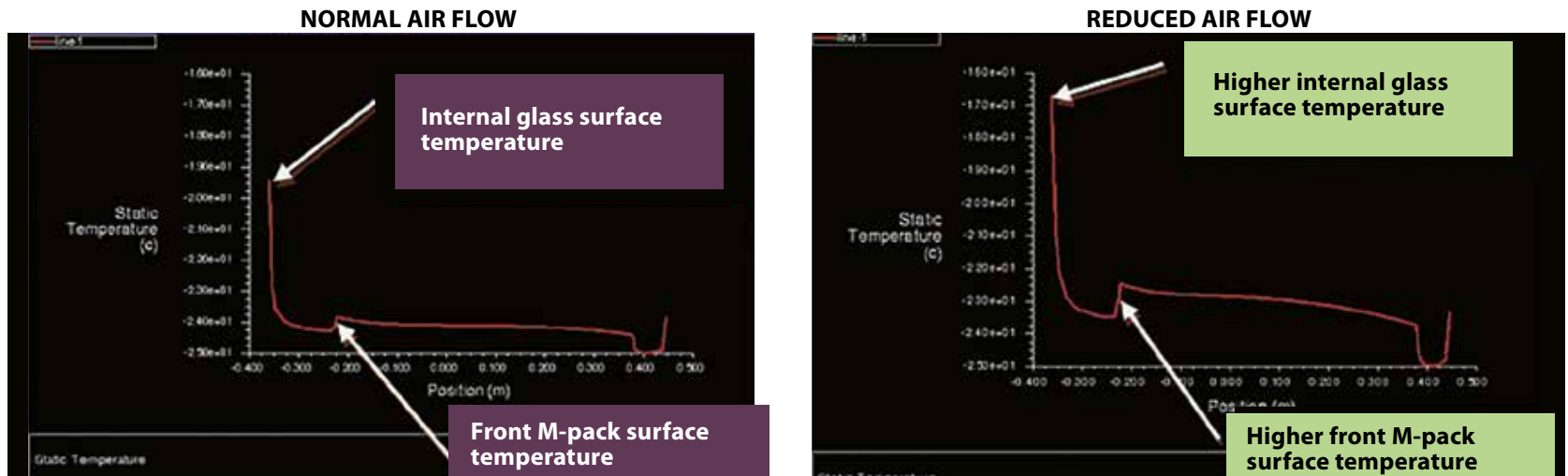
EVAPORATING TEMP. (february-march)	WATER LOOP	REMOTE STANDARD	REMOTE OPTIMIZED
<b>Vegetable (3H)</b>	2.3	-11.4	-9.0
<b>Fresh dairies (3M<sup>2</sup>)</b>	+1.3	-11.4	-9.0
<b>Meat (3M1)</b>	-3.2	-11.4	-9.0
<b>Serve over (3M1)</b>	-4.7	-11.4	-9.0
<b>Tradeo (3M)</b>	-1.8	-11.4	-9.0
<b>MT Cold Room</b>	-1.3	-11.4	-9.0
<b>LT cabinets (31.1)</b>	-26.7	-35.0	-35.0
<b>LT Cold Room</b>	-32.0	-35.0	-35.0

## B. VARIABLE SPEED FANS

Variable speed fans can be used in relation to the air-flow design of internal cabinets' air. The basic function of a refrigerated cabinet, complying with ISO EN 23953<sup>75</sup>, is to ensure that food always has a temperature within the limits given by a specific class of performance. In daily use, food is normally some degrees lower than the maximum allowed temperature as real heat loads are often lower than tested ones.

Using variable airflow is possible to adapt internal food temperature to the required level and save energy due to the increase of internal cabinet surfaces temperature and reduction of fan power.

**Figure 14.3 - Temperature inside cabinet with normal air flow and reduced air flow.** Source: EPTA.



To quantify the potential advantages, 3D Computational Fluid Dynamics (CFD) simulations have been run on a freezer cabinet. Table 14.2 shows a saving of -5.25%, and max m-pack temperature close to the temperature obtained in the Class test. Following data refer to the simulated small portion of a cabinet. Without reducing the speed, the temperature lowers by 1.2°C.

**Table 14.2 - Energy saving achieved using variable speed fan technology.** Source: EPTA.

	FAN POWER (W)	HER WITHOUT FANS (W)	HER SAVING %	HER WITH FANS (W)	HER SAVING %	REC (W)	REC SAVING %	MAX PACK T (K)	MAX PACK T (°C)
<b>CLASS TEST FULL LOAD, FULL SPEED</b>	2.5	87.1134	13.54%	89.61	13.12%	77.18%	12.64%	252.63	-17.52
<b>REDUCED LOAD, FULL SPEED</b>	2.5	76.7217	0.00%	79.22	0.00%	68.52%	0.00%	254.49	-18.66
<b>REDUCED LOAD OPTIMIZED REDUCED SPEED</b>	1.37	74.8926	-2.38%	76.26	-3.74%	64.92%	5.25%	255.73	-17.42

To further validate the concept and include dynamic behaviour, a number of experiments have been executed on three different cabinets: (1) a Vertical four door freezer, (2) a Combined Vertical-Chest freezer, and (3) a big vertical positive cabinet. In all cases savings from 5% to 9% were obtained.

<sup>75</sup> ISO 23953-2:2015. Refrigerated display cabinets - Part 2: Classification, requirements and test conditions.

## 14.2 CONFIGURATION OF AREA WITH DISPLAY REFRIGERATION CABINET AND INFLUENCE OF HEATING AND COOLING DISTRIBUTION SYSTEM

Radiant systems, installed in the ceiling or under the floor, represent advantageous alternatives to more traditional convective HVAC systems for supermarkets.

The interaction between refrigerated cabinets with closed doors and three kind of HVAC terminals is analysed both from an energy and from a thermal comfort point of view:

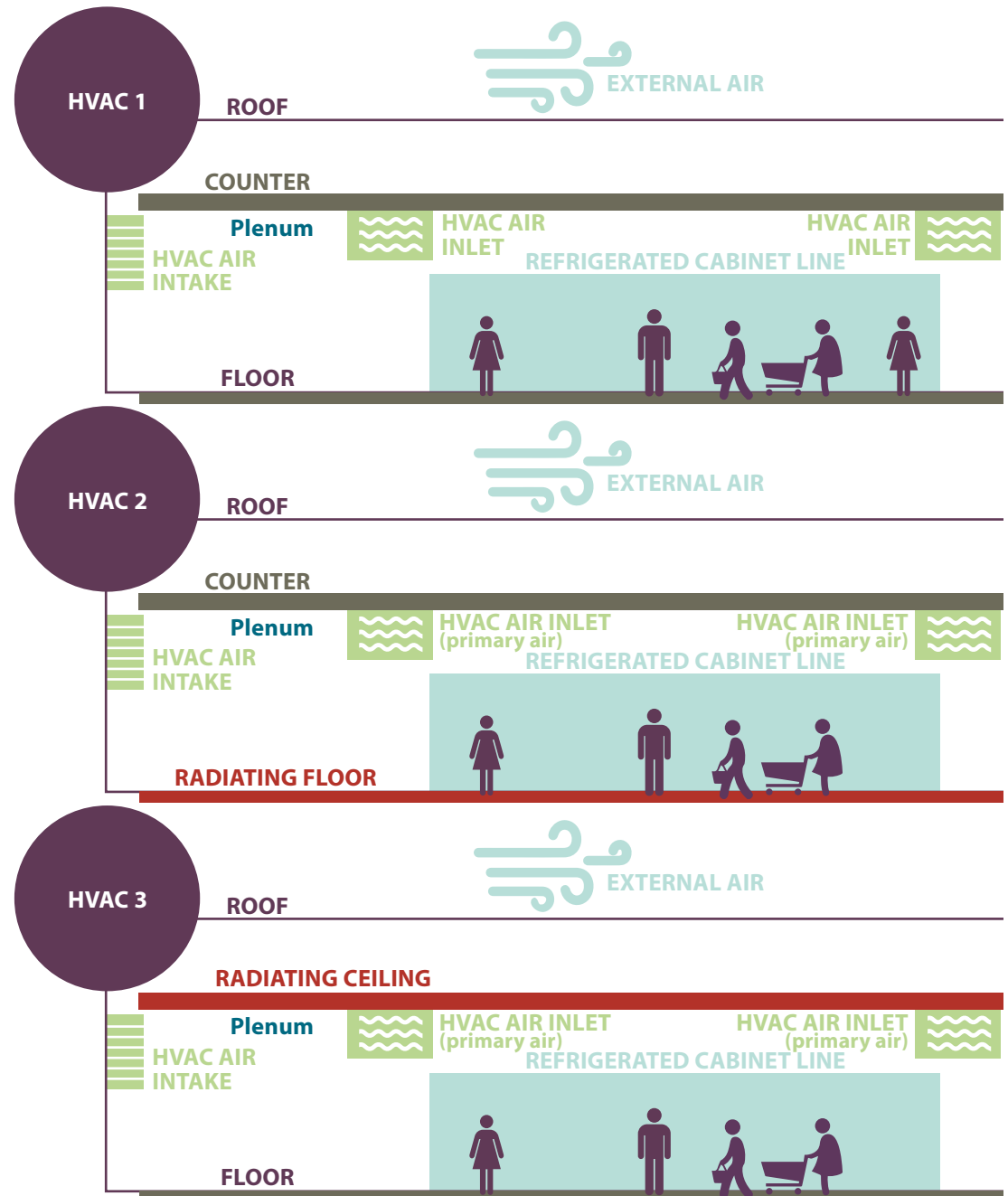
- Pure vented system (HVAC 1)
- Radiant floor and primary air supply (HVAC 2)
- Radiant ceiling and primary air supply (HVAC 3)

Radiant systems work together with a primary air-convective inlet, which ensures the required hygienic ventilation rates.

Two reference scenarios, representing common zone layouts in most food stores, have been investigated by means of a CFD technique (Figure 14.4):

- Low Temperature (LT) cabinets zone, composed of two lines of door closed vertical cabinets with a line of door-closed horizontal cabinets in the middle of the aisle;
- Normal Temperature (NT) cabinet zone, composed of two lines of door-closed vertical cabinets facing each other.

**Figure 14.4 - HVAC scenarios analysed: HVAC1 - pure vented, HVAC2 - radiating floor and primary air supply, HVAC3 - radiating ceiling and primary air supply.** Source EPTA.



Results obtained in winter condition. As hypothesis, the incoming heat is the same for all three systems.

The graphs in Figure 14.5 show the air temperature vertical gradient in the NT cabinets' zone layout with the three HVAC technologies mentioned previously.

**Figure 14.5 - Air Temperature in NT cabinets' zone in HVAC 1 HVAC 2 and HVAC 3. Winter conditions.** Source EPTA.

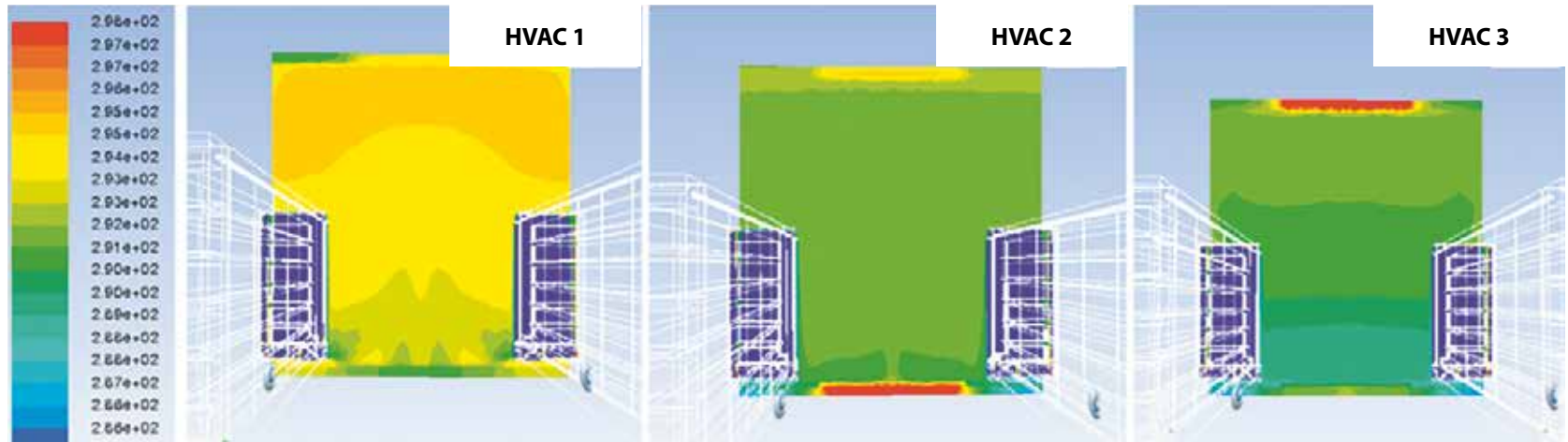


Table 14.3 reports the global and local comfort indicators calculated (by 3D Computational Fluid Dynamics simulations) using the predicted temperatures of LT and NT cabinets' zone layout. Radiant floor (HVAC 2) is more effective in reducing cold floor discomfort compared to the ceiling solution and happens to be the most energy-efficient one in winter conditions thanks to the fact that it can reach the highest PMV (Predicted Mean Vote) value among the three HVAC systems analysed.

**Table 14.3 - Global and local comfort indicators for HVAC 1 – pure vented, HVAC 2 - radiating floor and HVAC 3 - radiating ceiling scenario in winter conditions.** Source EPTA.

Key Performance Indicator		LT CABINETS			NT CABINETS		
		HVAC 1	HVAC 2	HVAC 3	HVAC 1	HVAC 2	HVAC 3
Global comfort	PMV [-]	0.12	0.18	-0.02	-0.33	0.23	-0.02
	PPD [%]	5.30	5.67	5.01	7.20	6.12	5.01
Local comfort	Mean air velocity [m/s]	0.06	0.03	0.03	0.20	0.07	0.05
	Draught Rate (DR)	2.86	0.00	0.00	16.17	5.49	0.00
	Air temperature vertical gradient [K]	7.17	1.47	3.78	0.90	0.21	1.29
	PD – Vertical air temperature differences [%]	59.33	1.10	7.42	0.68	0.38	0.94
	Floor temperature [°C]	17.91	22.50	19.01	18.60	27.46	18.50
	PD – floor temperature [%]	12.84	5.78	10.34	12.48	8.95	11.44
	Radiant temperature asymmetry – cold ceiling [K]	2.55	2.35	5.50	2.31	6.39	12.82
	Radiant temperature asymmetry – cold wall [K]	2.53	1.62	2.25	0.00	0.00	0.00

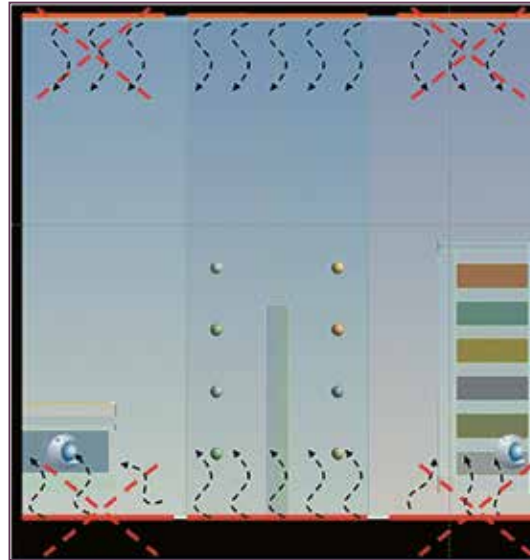
■ Class A ■ Class B ■ Class C ■ Discomfort

In order **to maximize the efficiency of radiant panels, they have to be placed in the central part of the aisle** to reduce the heat exchanged with the cabinets.

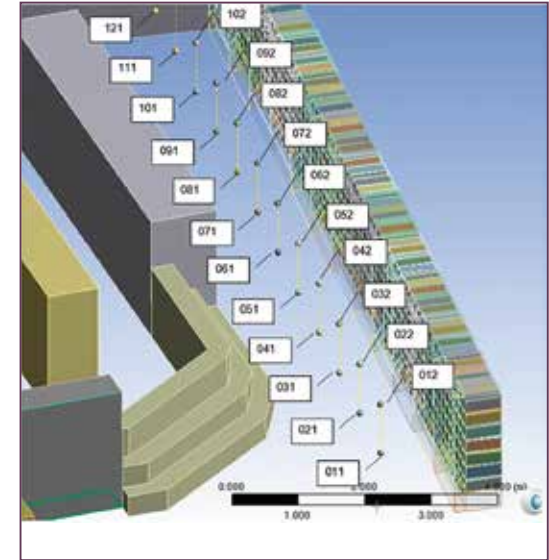
It clearly appears that, providing the same amount of heat, radiating panels (if correctly disposed) have an advantage for better comfort than full air systems.

An improved analysis has considered the CFD simulation of a real store, in which HVAC1, HVAC2 and HVAC3 have been applied obtaining the same level of global comfort, with the purpose to get the maximum energy savings from radiating technologies.

**Figure 14.6 - Floor and ceiling radiant panels recommended position.** Source: EPTA.



**Figure 14.7 - Probes position for comfort analysis.** Source: EPTA.



**Table 14.4 - Global and local comfort indicators for HVAC 1 – pure vented, HVAC 2 - radiating floor and HVAC 3 - radiating ceiling scenario in winter conditions.** Source EPTA.

Key Performance Indicator		HVAC 1	HVAC 2	HVAC 3
Global comfort	PMV [-]	-0.35	0.27	0.29
	PPD [%]	7.52	6.50	6.74
Local comfort	Mean air velocity [m/s]	0.20	0.11	0.11
	Draught Rate (DR)	17.35	9.81	9.81
	Air temperature vertical gradient [K]	5.20	3.35	5.17
	PD – Vertical air temperature differences [%]	21.27	5.25	20.84
	Floor temperature [°C]	17.89	21.20	19.62
	PD – floor temperature [%]	12.89	6.84	9.16
	Radiant temperature asymmetry – cold ceiling [K]	1.16	-1.15	4.12
	Radiant temperature asymmetry – cold wall [K]	3.20	3.80	3.90

■ Class A ■ Class B ■ Class C ■ Discomfort



**IN ORDER TO MAXIMIZE THE EFFICIENCY OF RADIANT PANELS, THEY HAVE TO BE PLACED IN THE CENTRAL PART OF THE AISLE TO REDUCE THE HEAT EXCHANGED WITH THE CABINETS.**

Working at the same comfort level, air volume temperature for HVAC2 and HVAC3 results in 1.5 °C less than for HVAC1 (18.1°C vs 19.6°C). By obtaining lower air temperatures, it has been possible to save energy.

Energy savings estimation for the two analysed radiant systems are summarized in Table 14.5. The heating demand can be reduced by up to 29% in case of radiant floor and 23% in case of radiant ceiling.

A supply water temperature of 37.5°C and a COP of 4.06 is considered for the pure vented system compared to a supply water temperature of 30°C and a COP of 4.63 for the radiant systems, thus giving an additional advantage to the energy saving.

The Return of Investment (ROI) of the radiant system solution is calculated in comparison with the pure vented technology.

For food stores located in climates with Heating Degree Days (HDD) between 2100 and 3000, the estimated ROI is 8.2 years for radiant floor and 9.7 years for radiant ceiling. For climates with HDD between 3901 and 4800, the estimated ROI lowers to 5.4 years for radiant floor and to 6.4 years for radiant ceiling.

**Table 14.5 - Energy savings provided by radiant technologies.**

	HVAC 1 Pure vented	HVAC 2 Radiant floor	HVAC 3 Radiant ceiling
<b>Temp inlet water</b>	37.5°C	~30°C	~30°C
<b>COP Heat Pump</b>	4.06	4.63	4.63
<b>Provided heat ratio respect to pure vented</b>	-	0.704	0.768
<b>Heating energy saving respect to pure vented</b>	-	29.6%	23.2%
<b>Total energy ratio respect to pure vented</b>	-	0.617	0.674
<b>Total energy saving respect to pure vented</b>	-	38.3%	32.6%

Since radiant heating panels work at lower temperature sources compared to convection systems, heat can be recovered from the condensation process used for refrigeration, thus lowering (or cancelling in the most favourable cases) the need for additional power for heating.

By assuming that all required heat is instead provided by the heat recovered from the condensing units of the refrigeration system, the estimated ROI can be reduced down to 2.1 years for both radiant floor and ceiling systems in climates

with HDD between 3901 and 4800. Estimated ROI is 3.2 years in climates with HDD between 2100 and 3000.

Further analyses executed in summer conditions show the perfect compatibility of the radiant technology also for the summer case.

While a bit less efficient, the installation of radiant ceiling in stores is considered to be more flexible than radiant floor.





## 14.3 AIR DIFFUSERS: EFFECTS ON COMFORT AND REFRIGERATION CABINETS

The optimization of thermal zoning meets several needs in grocery stores like energy saving, thermal comfort for customers and avoiding mist formation on glass doors of closed display cabinets. CFD simulations can be performed to assess different HVAC methods (all-air system, radiant floor and radiant ceiling). Performance indicators as Predicted Percentage of Dissatisfied (PPD) and Predicted Mean Vote (PMV), define the impact of different terminals on thermal comfort in the occupied space. Regarding mist formation, the air ventilation system can supply direct fresh air towards the cabinets through different diffusers (square, vortex, and linear). Their impact can be evaluated both in terms of mist removal potential and in terms of thermal comfort impact in the occupied space.

### 14.3.1 FULL-AIR SYSTEMS AND TRADITIONAL DESIGN (NO ENERGY SAVING)

When no radiant systems are provided, full-air HVAC or ducted fan-coil systems ensure the room thermal conditions by means of forced-air supplied through ceiling diffusers. In the display cabinet zones of the food stores, frequently located in open spaces, air is usually supplied from the ceiling. The most common ceiling diffusers can be classified as:

- Four-ways diffusers (Figure 14.8): squared geometry with slotted openings parallel to the square sides, the velocity of the supplied air has a predominant horizontal component, tangent to the ceiling surface;
- Vortex diffusers (Figure 14.9): the air velocity has a vertical component and a radial component that can be changed varying the geometry of the diffuser;
- Linear diffusers (Figure 14.10): long slots with deflectors to change the direction of the air flow.

**Figure 14.8 - Photo of a four-ways diffuser.**

Source: FCR ([www.fcr.it](http://www.fcr.it)).



**Figure 14.9 - Photo of a vortex diffuser.**

Source: FCR ([www.fcr.it](http://www.fcr.it)).

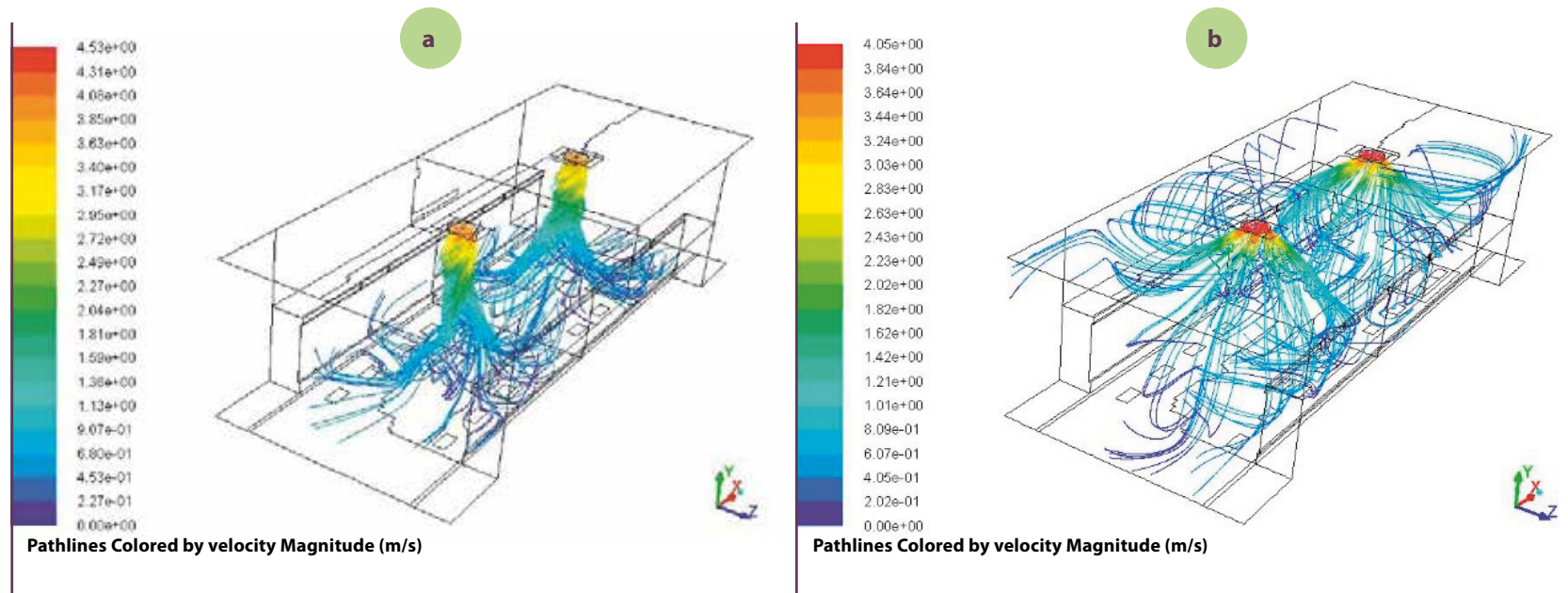


**Figure 14.10 - Linear ceiling diffuser.** Source: CLIMATECH.



In the zones of the supermarket where refrigerated display cabinets are installed, the traditional design of HVAC systems only aims at providing customer's global comfort conditions, without explicit reference to energy savings in the display cabinet zone. This can be achieved installing either four-ways or vortex diffusers as well. The behaviour of these kinds of diffusers allows a good mixed condition between supply air and internal air all over the occupied zone. As an example of the distribution of supply air by vortex diffusers, in Figure 14.11 the path lines of the air flow with two different orientation of the vortex winglets are shown.

**Figure 14.11 - Path lines through the vortex diffuser with wing deflection of 45° and no radial component (a), while in (b) the radial component is equal to the vertical component. The colours are based on velocity magnitude in m/s.** Source: O. Saro et al, (2016)<sup>76</sup>.



Designers have to comply with the usual comfort requirements as stated by European Standards (EN ISO 7730<sup>77</sup>, EN 15251<sup>78</sup>). Specifications on design guidelines for traditional air-diffusion problems in commercial environments fall outside the purposes of this project and can be found in several specialized handbooks. In this configuration, which is the usual design, the risk of mist formation on the glass of display cabinets is avoided by means of electrical resistances embedded in the frame of the display-cabinet doors.

<sup>76</sup> Saro O., De Angelis A., Cortella G. (May 22-25, 2016). Influence of Supply Air Ceiling Diffusers on Surface Temperature of Display Cabinet Doors and on Customers Comfort in Food Stores. Clima 2016, Heiselberg, P. K. (Ed.) Proceedings of the 12th REHVA World Congress. Aalborg, DK. Volume 5, paper 93.

<sup>77</sup> Comité Européen de Normalisation (CEN). (2005). Ergonomie des ambiances thermiques - Détermination analytique et interprétation du confort thermique par le calcul des indices PMV et PPD et par des critères de confort thermique local; Ergonomics of the thermal environment - Analytical determination and interpretation of thermal comfort using calculation of the PMV and PPD indices and local thermal comfort criteria (ISO 7730:2005).

<sup>78</sup> Comité Européen de Normalisation (CEN). (2007). EN 15251 Critères pour l'environnement intérieur et évaluation des performances énergétiques des bâtiments couvrant la qualité d'air intérieur, la thermique, l'éclairage et l'acoustique; Indoor environmental input parameters for design and assessment of energy performance of buildings addressing indoor air quality, thermal environment, lighting and acoustics.

### 14.3.2 FULL-AIR SYSTEMS AND ENERGY SAVING MANAGING THE RISK OF MIST FORMATION

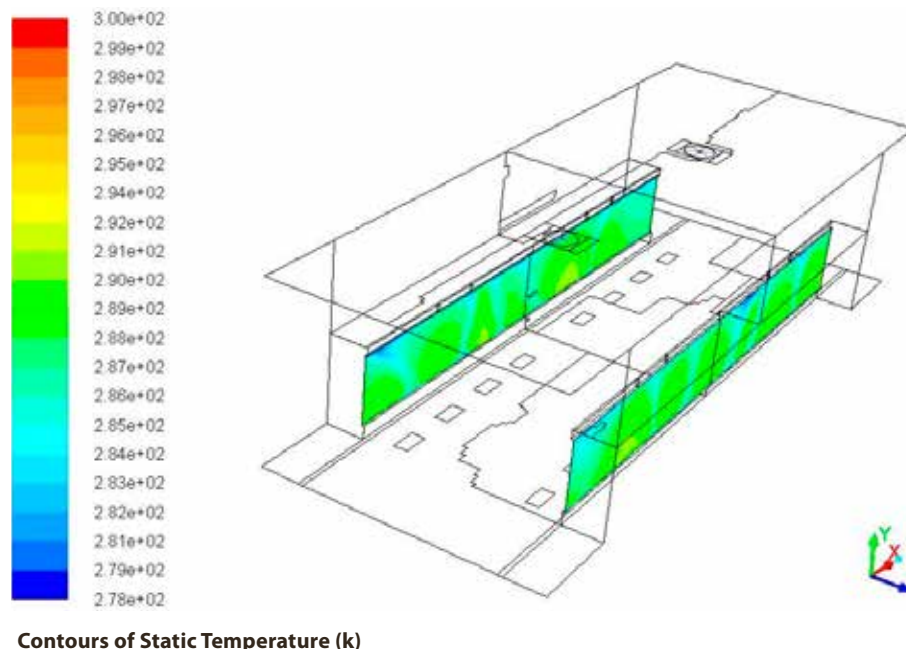
Dealing with energy savings while managing the risk of mist formation means reducing the use of electrical heaters, in terms of time and/or power. Increasing the external surface temperature of cabinet doors looks like the most affordable way, and it can be achieved by exploiting the flow of supply air, with a proper choice of air diffusers.

The results obtained from studies carried on in this project show that the vortex and four-ways ceiling diffusers do not perform well to obtain a uniform distribution of temperature on the glass of the cabinet doors. In fact, as can be seen in Figure 14.11, by means of vortex ceiling diffusers, the supply air mixes well with the internal air of the display zone but the flow field produces neither vertical neither horizontal uniformity in the thermal field on the display cabinets' doors. Figure 14.12 shows the thermal field on the surface of the glass door of display cabinets; the non-uniform temperature distribution is clear. Similarly, the four way diffusers distribute air at an almost horizontal direction tangentially to the ceiling, in such a way that air temperature in the vicinity of the cabinet doors is quite similar to the average ambient temperature, thus contributing negligibly to enhancing glass surface temperature.

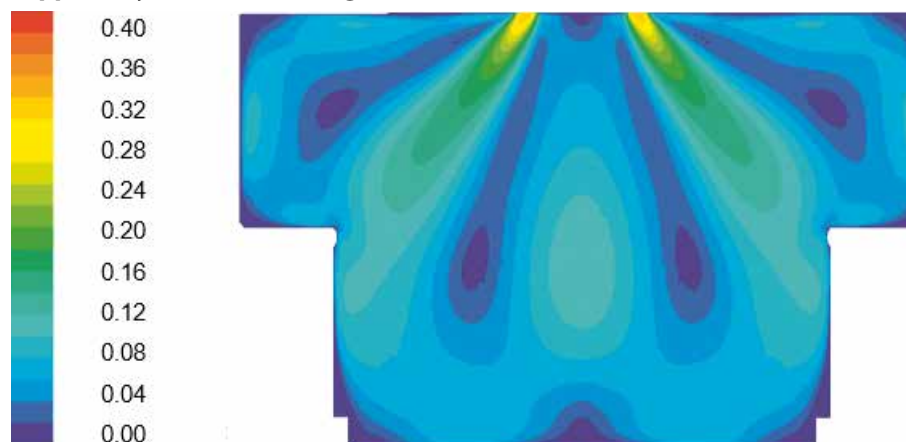
The diffuser that performs better is the linear diffuser with adjustable jet angle. The velocity field calculated when linear diffusers suitably adjusted are employed shows air flowing directly over the glass surfaces of cabinet doors (Figure 14.13). The convective coefficient assumes higher values with respect to the other solutions, thus reducing the thermal resistance on the glass surface and the temperature difference between the room and the glass surface.

A sketch of the suggested installation for the linear ceiling diffusers in the display cabinets zone is given in Figure 14.14.<sup>81</sup>

**Figure 14.12 - Surface temperature of the door glass when air is supplied by vortex diffusers with wing deflection of 45° and no radial component. The colours are based on temperature values in K.** Source: O. Saro et al, (2016)<sup>79</sup>.



**Figure 14.13 - Velocity field (m/s) on the central plane of the aisle with air symmetrically supplied by two linear ceiling diffusers.** Source: O. Saro et al, (2016)<sup>80</sup>.



<sup>79</sup> Saro O., De Angelis A., Cortella G. (May 22-25, 2016). Influence of Supply Air Ceiling Diffusers on Surface Temperature of Display Cabinet Doors and on Customers Comfort in Food Stores. Clima 2016, Heiselberg, P. K. (Ed.) Proceedings of the 12th REHVA World Congress. Aalborg, DK. Volume 5, paper 93.

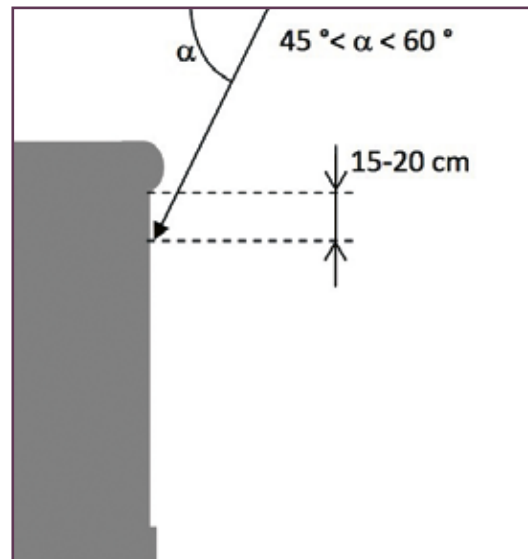
<sup>80</sup> Ibid.

<sup>81</sup> O. Saro, A. De Angelis, G. Cortella; Influence of Supply Air Ceiling Diffusers on Surface Temperature of Display Cabinet Doors and on Customers Comfort in Food Stores. Clima 2016, Heiselberg, P.K. (Ed.) Proceedings of the 12th REHVA World Congress, 22-25 May 2016, Aalborg, (DK), Volume 5, Paper 93.

The temperature distribution on the glass surface of the cabinet doors is quite uniform in the horizontal direction. However, a vertical temperature gradient remains, thus leading to the possible need of increasing air supply velocity to reduce the risk of mist formation on the lower part of doors in case of vertical display cabinets for frozen food.

The solution appears effective in terms of energy savings, which can be achieved combining a suitable distribution of the supplied air with a control system for the electrical heaters, able to identify the incipient mist formation. This is a commercially available option, applied to the control of radiant panels for room cooling purposes. Further savings in energy and investment costs can be obtained installing the heaters only on the lower part of the doors below the incidence point of the air jet.

**Figure 14.14 - Suggested solution for the installation of the linear ceiling diffusers, the desired result can be obtained adjusting the position of the diffuser and the direction of the supply airflow to obtain the correct incident angle of the air jet and the position of the incidence on the surface of cabinet door glass as showed in the draft.** Source: O. Saro et al, (2016)<sup>80</sup>.



**DEALING WITH ENERGY SAVINGS WHILE MANAGING THE RISK OF MIST FORMATION MEANS REDUCING THE USE OF ELECTRICAL HEATERS, IN TERMS OF TIME AND/OR POWER.**

## REFERENCES

ISO 23953-2:2015. Refrigerated display cabinets - Part 2: Classification, requirements and test conditions.

Comité Européen de Normalisation (CEN). (2005). Ergonomie des ambiances thermiques - Détermination analytique et interprétation du confort thermique par le calcul des indices PMV et PPD et par des critères de confort thermique local; Ergonomics of the Thermal Environment - Analytical determination and interpretation of thermal comfort using calculation of the PMV and PPD indices and local thermal comfort criteria (ISO 7730:2005).

Comité Européen de Normalisation (CEN). (2007). EN 15251 Critères pour l'environnement intérieur et évaluation des performances énergétiques des bâtiments couvrant la qualité d'air intérieur, la thermique, l'éclairage et l'acoustique; Indoor environmental input parameters for design and assessment of energy performance of buildings addressing indoor air quality, thermal environment, lighting and acoustics.

Saro O., De Angelis A., Cortella G. (May 22-25, 2016). Influence of Supply Air Ceiling Diffusers on Surface Temperature of Display Cabinet Doors and on Customers Comfort in Food Stores. Clima 2016, Heiselberg, P. K. (Ed.) Proceedings of the 12th REHVA World Congress. Aalborg, DK. Volume 5, paper 93.

Commercial refrigeration application of variable speed compressor and variable speed fans for improved off-design efficiency. Orlandi M. / Visconti F. M. / Ruggeri A. Le ultime tecnologie del freddo e del condizionamento. Atti del 16° Convegno Europeo: June 12-13, 2015, Milano, Italia. 2015.06.12-13 - Paper available on <http://www.iifir.org/>



System applied in Modena Canaletto, Italy. Source: CommONEnergy.

# 15.

## NOVEL ENERGY DISTRIBUTION LAYOUT AND GENERATION TECHNOLOGIES

### 15.1 USE OF CARBON DIOXIDE (CO<sub>2</sub>) HEAT PUMP IN DIFFERENT CLIMATE CONDITIONS

Carbon dioxide operating according to a transcritical cycle is regarded as an energy efficient option for water heat pumps: the gas cooling process fits well the warming up of a finite stream of water, resulting in a quite large temperature lift in water without significant penalization in the so-called coefficient of performance (COP), as it was clearly demonstrated in the technical literature.

#### 15.1.1 CO<sub>2</sub> REFRIGERANT CHARACTERISTICS

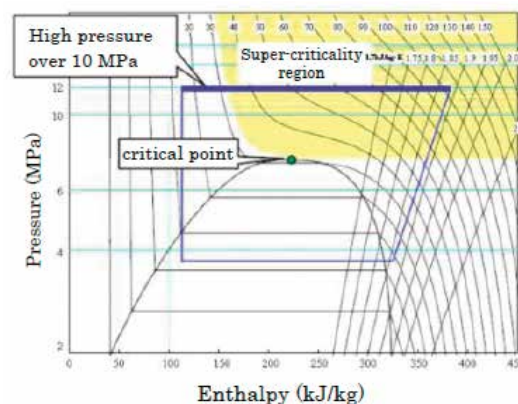
Studies were conducted to compare the performance of CO<sub>2</sub> refrigerant to HFC refrigerants (like R410A, R407C) for use in residential and commercial heat pump water heaters.

A CO<sub>2</sub> heat pump that heats water using supercritical CO<sub>2</sub> efficiently heats water from low to high temperatures in the most basic single-stage compressor cycle. In particular, when the refrigeration plant goes in transcritical operation, a very high temperature able to heat water up to 90°C can be achieved.

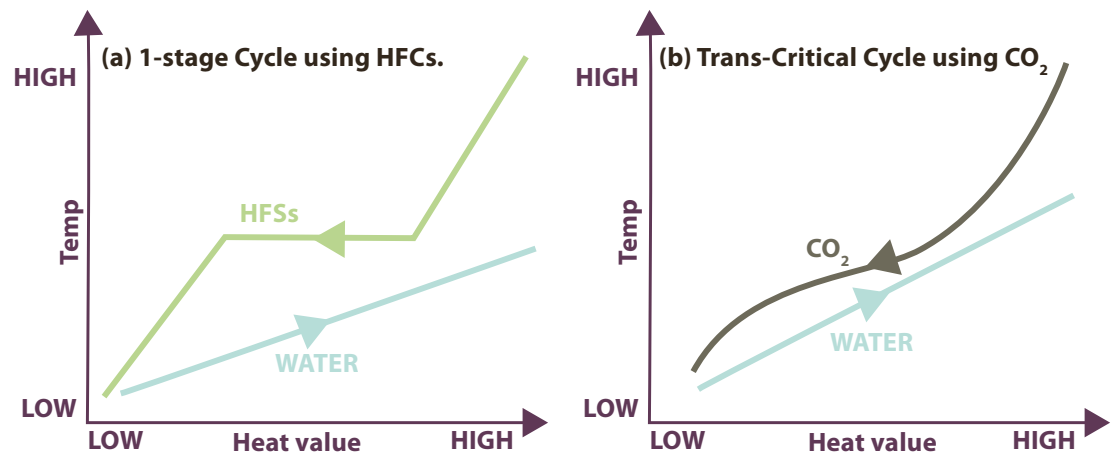
Fluid in a supercritical condition does not undergo a phase change, so the temperature of CO<sub>2</sub> drops gradually as the water is heated; the temperature difference between the water and CO<sub>2</sub> is almost unchanged while heat is exchanged. This means a smaller irreversible loss in the water heat exchanger that exchanges heat between water and refrigerant, so a smaller and a more compact heat exchanger component is achieved.

This is the main reason why CO<sub>2</sub> refrigerant is suitable for water heaters and other single-pass heating applications with large temperature differences, which heat water from low to high temperatures.

**Figure 15.1 - Pressure-Enthalpy of CO<sub>2</sub> refrigerant highlighting transcritical region.** Source: EPTA.



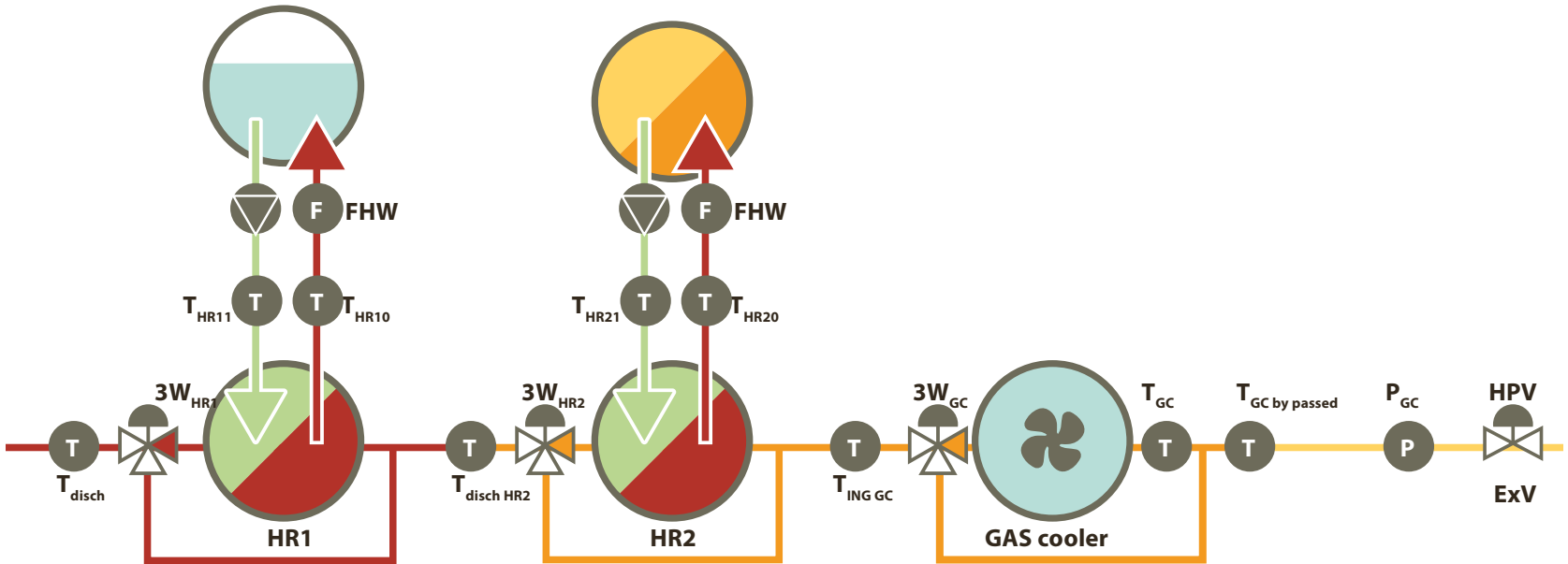
**Figure 15.2 - Temperature-Heat diagrams comparison between HFCs and CO<sub>2</sub> refrigerants.** Source: EPTA.



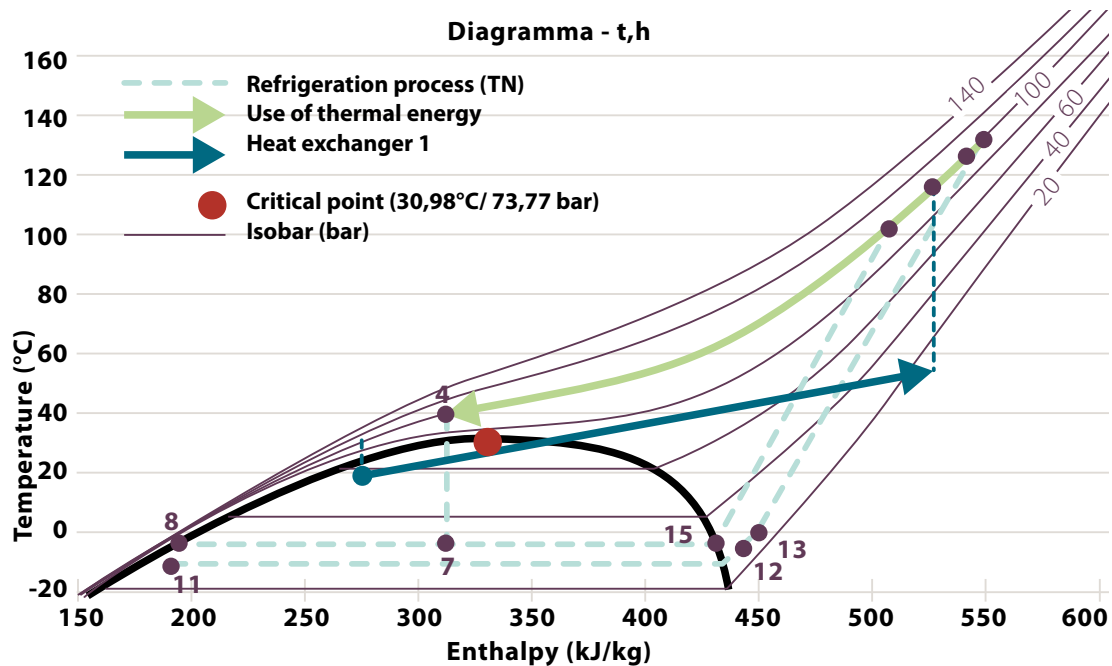
### 15.1.2 TRANS-CRITICAL SYSTEM FOR HEAT RECOVERY

In hot external conditions, a compressor discharge temperature greater than 100°C can be reached. This heating power, otherwise dissipated in the external environment, can be used by a high-medium temperature water circuit.

**Figure 15.3 - Concept layout of a heat recovery system through with water circuits.** Source: EPTA.

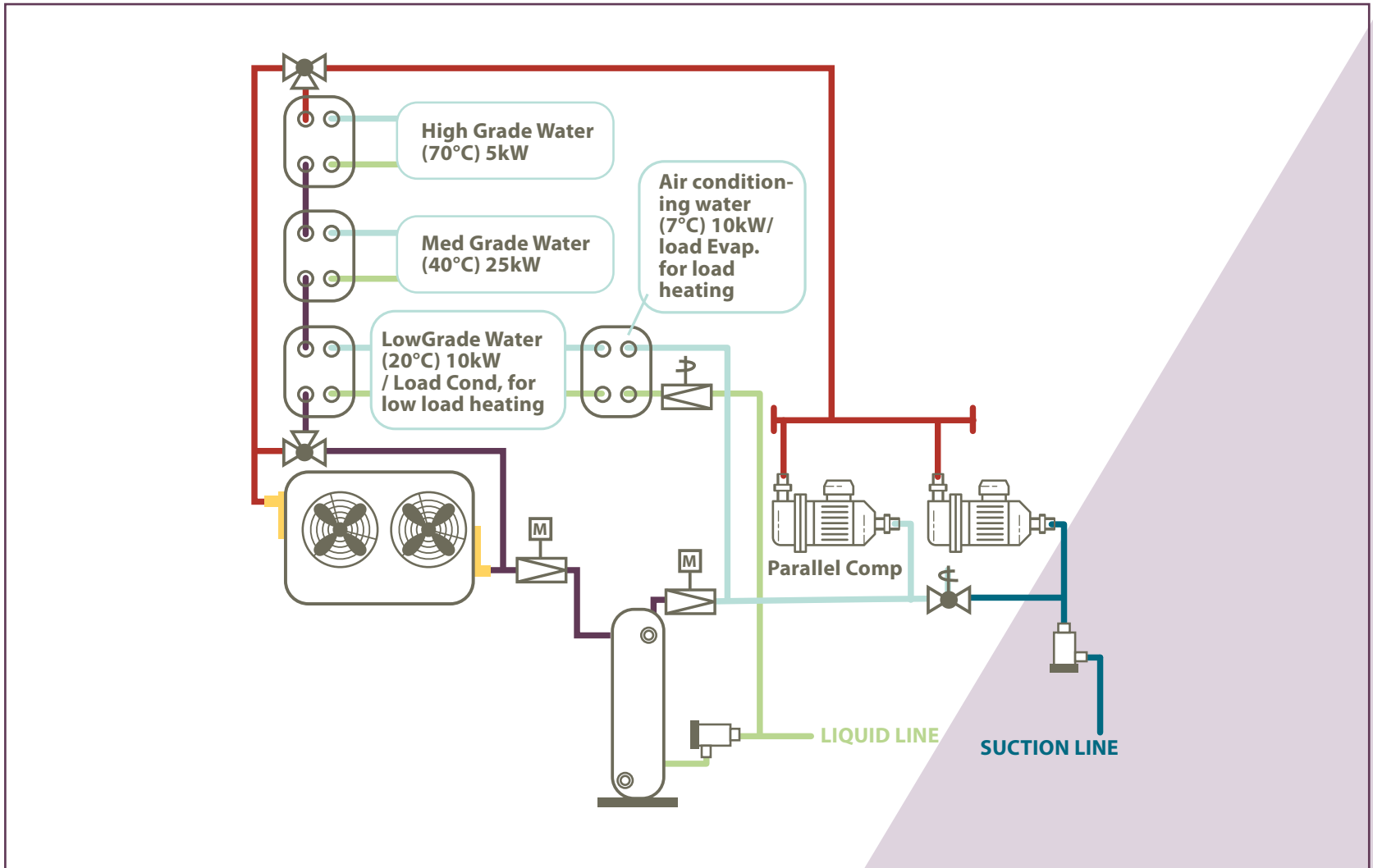


**Figure 15.4 - Temperature-Enthalpy diagram representing thermal energy from CO<sub>2</sub> side (red line) and water side (blue line), by Bitzer software calculator.** Source: EPTA.



The water circuit can be combined with a storage tank designed to maintain internal water stratification depending on different temperatures and linked to different heat exchangers, like shown in figure 15.5.

**Figure 15.5 - Concept layout of a three stages heat recovery system.** Source: EPTA.





In winter conditions, the wide possibility of regulation of the high-pressure valve is able to modulate the pressure of the gas cooler. Like this, the system runs as a standard transcritical system with the possibility to actively modify the set-point of the discharging pressure, so as to modify the thermal power and temperature recovered by the heat exchanger(s).

The system can also activate an A/C heat exchanger to produce cooling power for the building. The A/C heat exchanger has a dedicated evaporating level. This level is the same as the one of the liquid receiver and can be used as well to remove flash gas from the pack.

**Table 15.1 - Field test.**

	HIGH GRADE WATER	MEDIUM GRADE WATER	LOW GRADE WATER	AIR CONDITIONING WATER
POWER	5 kW	25 kW	10 kW	10 kW
TEMP. IN	70°C	35°C	25°C	12°C
TEMP. OUT	75°C	40°C	20°C	7°C

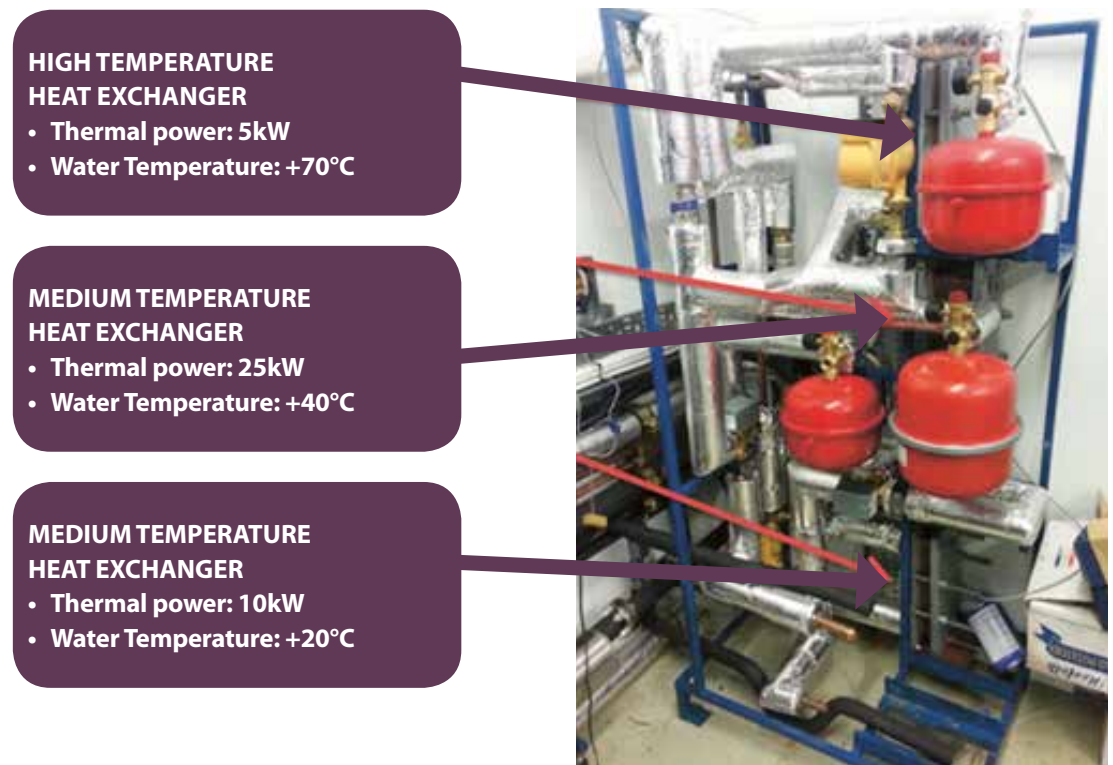
A dedicated control system for the high-pressure side has to be developed to maximize the heat pump COP while the water mass flow is adjusted to maintain the set water temperature and the heating request. The control system usually involves different regulation devices like:

- Pumps on water side;
- 3-way valves on refrigerant side;
- Flow switches.

They receive input signal from e.g. temperature and pressure probes.

**Figure 15.6 - Three level heat exchanger for an all in one solution transcritical system.**

Source: EPTA.



## 15.2 COUPLING HVAC + REFRIGERATION

Shopping centres often include a supermarket with a centralized refrigeration system. Energy savings can be achieved not only making the display cabinets and the Commercial Refrigeration Units (CRU) more efficient but also promoting synergies with the HVAC system in order to reduce the energy need by means of peak-shaving and energy recovery procedures. Among the different levels and solutions for integration<sup>82</sup>, those involving CO<sub>2</sub> should be considered, as this is the most viable choice for the replacement of HFCs refrigerants in commercial refrigeration in terms of reduction of the environmental impact.

In commercial refrigeration, where two evaporating temperatures are involved, i.e. the Low Temperature (LT) to supply the equipment for frozen food and the Medium Temperature (MT) for chilled food, the “booster” configuration with a mid-pressure receiver is considered as the baseline to achieve better efficiency in CO<sub>2</sub>-only systems. A scheme of the system is shown in Figure 15.7. The auxiliary compressor, sketched in dashed line, has proven to be an essential enhancement for a good performance in summer.

Due to the low critical point of CO<sub>2</sub> (31°C and 73.8 bar), the discharge of heat at outdoor conditions leads the system to operate in subcritical conditions only when the outdoor temperature is below approximately 25°C. Otherwise the system operates in transcritical conditions, the condenser is actually a ‘gas cooler’, where the CO<sub>2</sub> is cooled down from 120-140 °C to 20-40 °C, and the efficiency is much lower. This peculiarity of

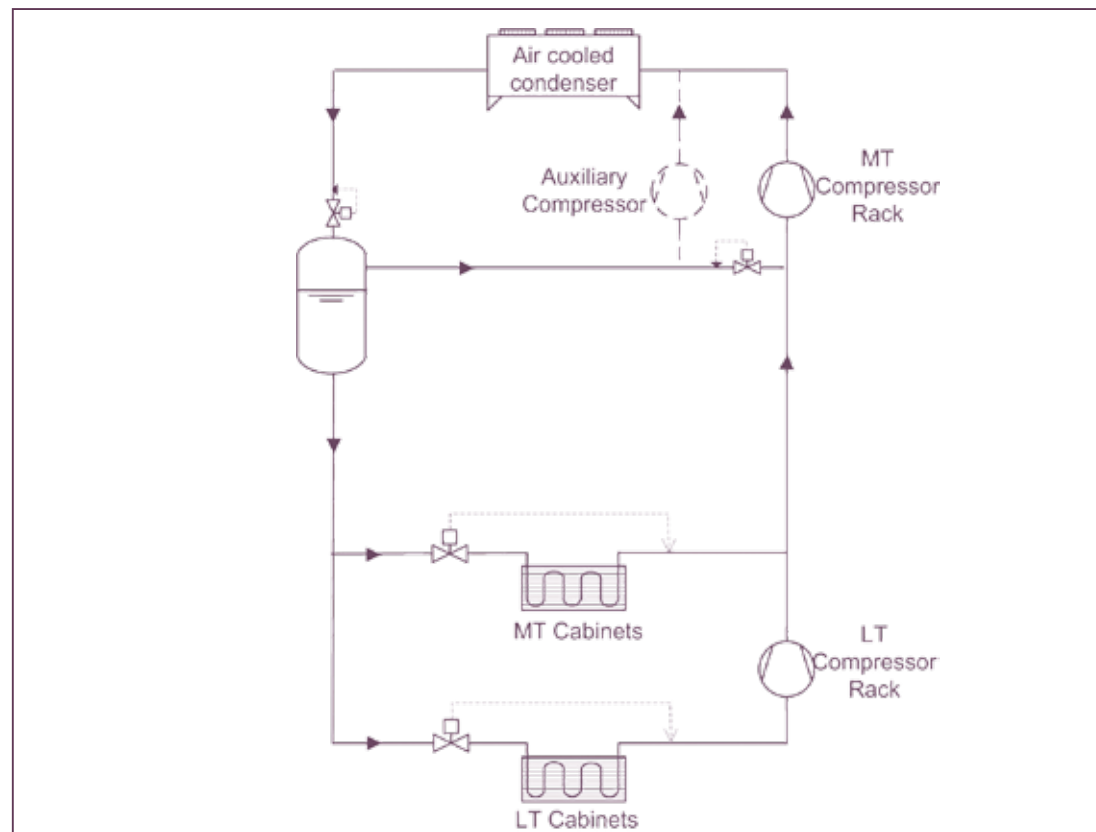
thermodynamic cycle is the reason why CO<sub>2</sub> has been chosen in a large number of supermarkets in Northern Europe<sup>83</sup>, while its diffusion in the mild/warm climates has been requiring many efforts to investigate configurations with a comparable efficiency to HFC refrigerants<sup>84-85</sup>.

Nevertheless, the high temperature reached at the compressor exit gives the chance to a useful heat recovery. Three scenarios are presented as examples here, at increasing complexity levels. They have been selected among the most effective

solutions whose components are commercially available. It should be mentioned that further solutions are being investigated which consider the effective adoption of one or more ejectors, but to date their components and control systems are not yet fully available.

Due to the extreme variability of shopping centres operating conditions and thermal load requirements, the energy savings for each specific case and climate should be estimated through the dynamic simulation of the integrated systems.

**Figure 15.7 - Sketch of a CO<sub>2</sub> booster system with mid pressure receiver and auxiliary compressor (dashed line).** Source: UNIUD.



<sup>82</sup> Cortella G., D'Agaro P. (2015). Chapter 10: Integration of air conditioning, refrigeration and energy generation in supermarkets, "Sustainable Retail Refrigeration". Ed. J. A. Evans and A. M. Foster, John Wiley & Sons. Chichester, UK.

<sup>83</sup> Masson N., Jia H., Burkel S. (January 2014). Shecco GUIDE 2014: Natural Refrigerants - Continued Growth & Innovation in Europe. Shecco Publications.

<sup>84</sup> Finckh O., Schrey R., Wozny M. (2011). Energy and efficiency comparison between standardized HFC and CO<sub>2</sub> transcritical systems for supermarket applications. International Congress of Refrigeration. Prague, Czech Republic.

<sup>85</sup> Matthiesen O., Madsen K., Mikhailov A. (2010). Evolution of CO<sub>2</sub> systems design based on practical experiences from supermarket installations in northern Europe. 9th IIR Gustav Lorentzen Conference on Natural Working Fluids. Sydney, Australia.



**THE EASIEST  
LEVEL OF  
INTEGRATION  
IS THE HEAT  
RECOVERY  
FROM THE CO<sub>2</sub> AT  
THE EXIT OF THE  
HIGH STAGE (HS)  
COMPRESSORS<sup>86</sup>.**

### 15.2.1 INTEGRATION THROUGH HEAT RECOVERY FROM THE DE-SUPERHEATER

The easiest level of integration is the heat recovery from the CO<sub>2</sub> at the exit of the High Stage (HS) compressors<sup>86</sup>.

The scheme of the system is depicted in Figure 15.8. Two heat exchangers recover heat at at least two different temperature levels. The first one (HX1) is used for the production of Domestic Hot Water (DHW) while the second one (HX2) supplies hot water for space heating purposes. When the system is running in heat recovery mode, the air-cooled gas cooler/condenser allows cooling down the refrigerant exiting the heat exchangers. Otherwise, the two heat exchangers are by-passed and the whole heat is rejected to the environment or, possibly, a third heat exchanger (HX3) can be introduced as sub-cooler for the CO<sub>2</sub> and heat source for air re-heating during the cooling season.

It is important to underline that, while the DHW request is easily covered all over the year by the refrigeration system, the heating demand could be greater than the heat rejected by the refrigeration

system at the optimum discharge pressure. In this case, this is possible to either cover just a fraction of the building heating demand or to control the refrigeration system (i.e. the discharge pressure) to increase the heat recovery, accepting a detriment in the efficiency. Furthermore, the system can be provided with an air-cooled “load evaporator” to be activated during low refrigeration duty periods, when the heat rejected by the HX2 heat exchanger is not sufficient to meet the heating demand.

As an example, in Table 15.2, the annual energy reduction has been calculated for different climate conditions assuming that the DHW demand is completely covered and the heating demand is partially covered by the heat rejected by the booster system<sup>87</sup>. In the reference case, the booster system supplies the refrigeration load and two R410a heat pumps supply the DWH and heating demands.

**Table 15.2 - Energy savings from heat recovery for different climates.**

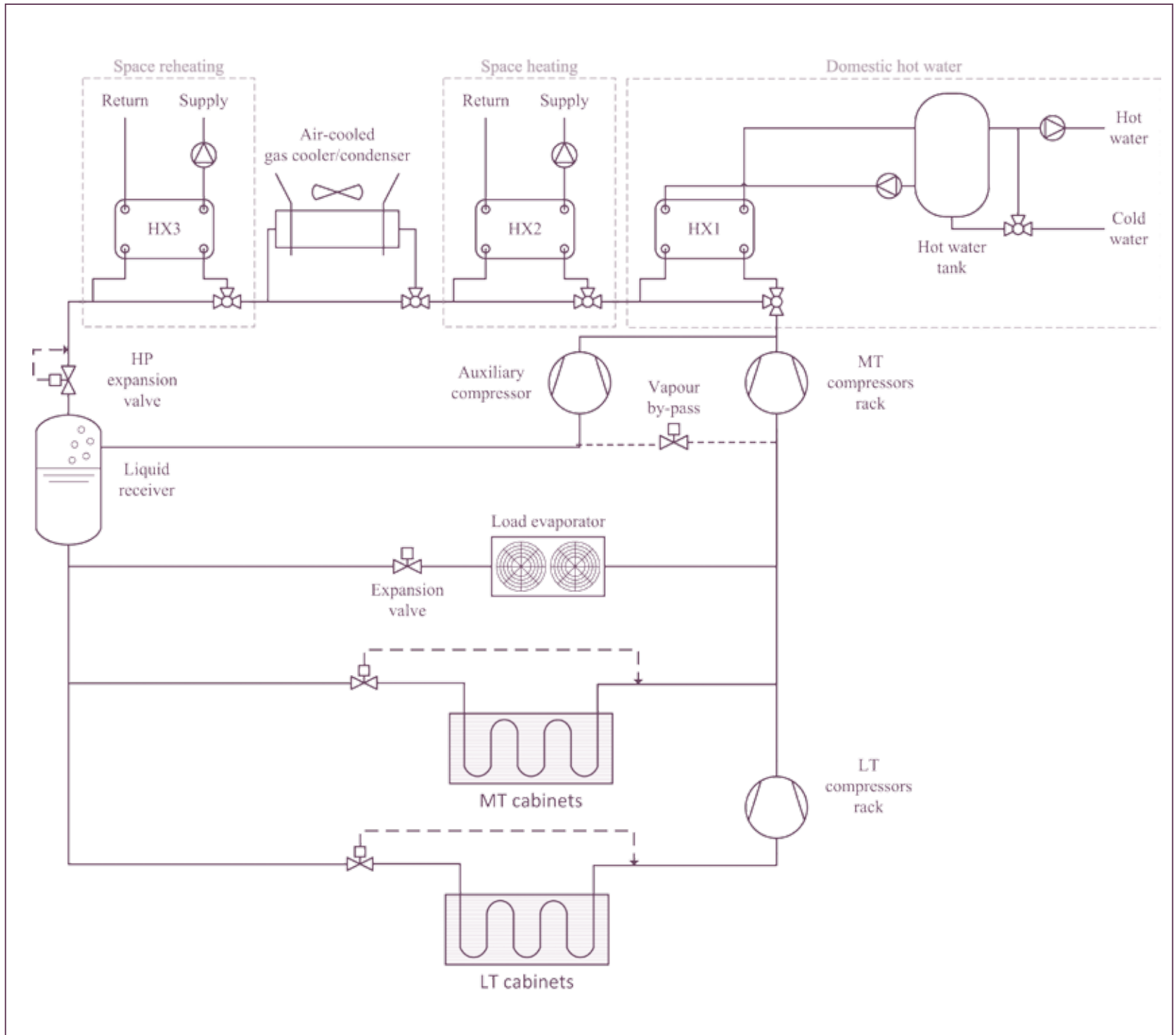
		CLIMATE A	CLIMATE B	CLIMATE C
<b>HEATING DEGREE DAYS</b>	HDD	1435	2323	2617
<b>HEATING DEMAND COVERED WITH ENERGY REJECTED BY “BOOSTER”</b>	[%]	68	50	49
<b>RELATIVE ANNUAL ENERGY CONSUMPTION</b>	[%]	-4.7%	-4.8	-4,9

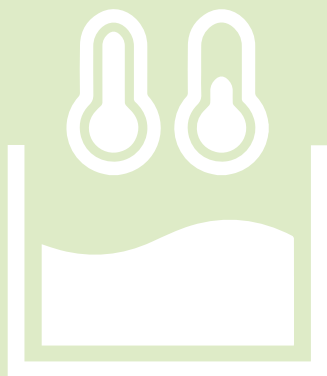
<sup>86</sup> Sawalha S., 2013, Investigation of Heat Recovery in CO<sub>2</sub> trans-critical solution for supermarket refrigeration, International Journal of Refrigeration, 36, 145-156.

<sup>87</sup> Polzot, A., Paride G., D'Agaro, P., Cortella, G. (2016). Performance Evaluation of a R744 Booster System for Supermarket Refrigeration, Heating and DHW, In: Proceedings of the 12th IIR Gustav Lorentzen Conference on Natural Refrigerants (GL2016). Edinburgh, United Kingdom. Paper 1022.

**Figure 15.8 - Sketch of a CO<sub>2</sub> booster system with two different heat recovery temperature levels and an additional air-cooled evaporator.**

Source: UNIUD.





“**THE MAIN CONCERN FOR MILD CLIMATES IS COOLING BELOW THE AMBIENT TEMPERATURE THE REFRIGERANT ON THE HIGH-PRESSURE SIDE.**”

### 15.2.2 INTEGRATION THROUGH WATER RESERVOIR

The main concern for mild climates is cooling below the ambient temperature the refrigerant on the high-pressure side. Among the different solutions, the most common are the internal heat exchanger<sup>88</sup> and the “mechanical sub-cooling” i.e. performing sub-cooling with another refrigeration unit<sup>89</sup>. Another solution, studied in the framework of CommONEnergy, is sketched in Figure 15.9. It takes advantage of a water tank for the fire prevention system by using it as a cold sink for performing sub-cooling of the Commercial Refrigeration Unit (CRU) and allowing heat recovery in favour of heat pumps (HP) for heating purposes<sup>90</sup>. The water tank acts as a large buffer and profitably disconnects heat demand and supply.

Generally, if the heat pump is operating for heating purposes, as much heat as possible is recovered from the refrigeration plant in favour of the heat pump even by-passing the gas cooler if considered worthwhile.

When the heat pump is not operating, the water tank is used as a cold storage to eventually perform further cooling of the refrigerant exiting the gas cooler/condenser. The effectiveness of such a solution should be evaluated on an annual basis, because substantial peak shaving and energy savings can be achieved by sub-cooling in summer time, but a detriment can occur in the performance when heat recovery has to be performed in winter time.

**Table 15.3 - Annual electric energy consumption in “climate B” for CRU and HP and energy saving with respect to the corresponding consumption of the baseline (same heating demand, separated systems). The three cases (H10, H20, H30) are referred to increasing thermal insulation of the building<sup>90</sup>.**

	CRU [MWH]	HP [MWH]	BASELINE [MWH]	CRU ENERGY SAVING [%]	HP ENERGY SAVING [%]	GLOBAL ENERGY SAVING [%]
<b>CASE H10</b>	188.39	119.94	325.00	4.7%	5.8%	5.1%
<b>CASE H20</b>	190.27	103.86	310.85	3.7%	8.3%	5.4%
<b>CASE H30</b>	190.63	90.24	296.69	3.5%	8.9%	5.3%

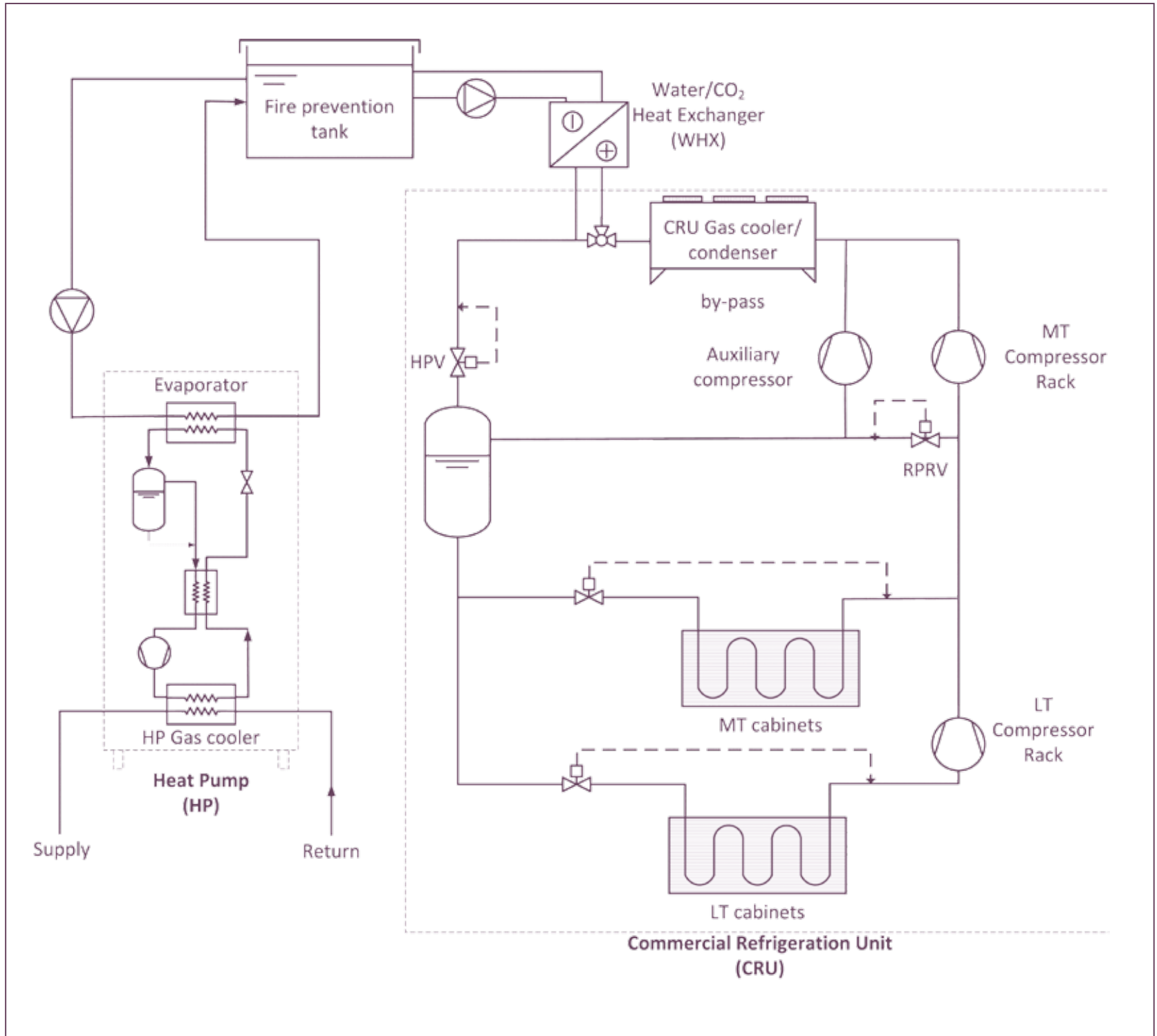
<sup>88</sup> Cavallini, A., Corradi, M., Fornasieri, E. (2007). Experimental investigation on the effect of the internal heat exchanger and intercooler effectiveness of the energy performance of a two stage transcritical carbon dioxide cycle. 22nd Int. Congress of Refrigeration. Beijing, China.

<sup>89</sup> Llopis R, Cabello R, Sanchez D, Torrella E. (2015). Energy improvement of CO<sub>2</sub> transcritical refrigeration cycles using dedicated mechanical subcooling. International Journal of Refrigeration. 55:129-141. DOI: 10.1016/j.ijrefrig.2015.03.016

<sup>90</sup> Polzot, A., D'Agaro, P., Cortella, G., Gullo, P. (2016). Supermarket refrigeration and air conditioning systems integration via a water storage. In: Proceedings of the 4th IIR International Conference on Sustainability and the Cold Chain. Auckland, New Zealand.

<sup>91</sup> Polzot, A., D'Agaro, P., Cortella, G., Gullo, P. (2016). Supermarket refrigeration and air conditioning systems integration via a water storage. In: Proceedings of the 4th IIR International Conference on Sustainability and the Cold Chain. Auckland, New Zealand.

**Figure 15.9 - Sketch of a CO<sub>2</sub> booster system (CRU) integrated to the heat pump (HP) through the fire prevention tank. Source: UNIUD.**





**IN SHOPPING CENTRES, IT OFTEN OCCURS THAT, BECAUSE OF DIFFERENT INTERNAL GAINS AND ORIENTATION, SOME SHOPS/ZONES NEED SPACE HEATING WHILE OTHERS NEED SPACE COOLING AT THE SAME TIME.**

### 15.2.3 INTEGRATION TO WATER LOOP HEAT PUMP SYSTEM

In shopping centres, it often occurs that, because of different internal gains and orientation, some shops/zones need space heating while others need space cooling at the same time. If this happens for an appreciable period in the year, a Water Loop Heat Pump system (WLHP) may be considered as HVAC solution.

A water loop is used as a heat source/sink for a number of electric reversible heat pumps which provide climate control on the different thermal zones of the building<sup>92</sup>. When cooling and heating loads are close to balance each other, the equilibrium is approached, otherwise a heater or a cooler must be activated. Thus, heat recovery from the refrigeration circuit can be profitably performed in the winter season by heating up the water loop through the high-pressure side heat exchanger of the refrigeration system as sketched in Figure 15.10. When the amount of heat available from the refrigeration system is low, the water loop temperature can be increased through an auxiliary heater. In the summer, when all the heat pumps

are operating for air cooling, a dry cooler on the water loop allows heat rejection to ambient air.

The performance of the system is obviously influenced by the temperature of the water loop and thus by the set-point values that control the activation of the heat recovery from refrigeration, the activation of the auxiliary heater or that of the dry-cooler. To give an idea of the global energy savings on annual bases, the annual electric energy consumption in “climate A” for water loop heat pump integrated with a booster (WLB) compared to the baseline i.e. a traditional direct expansion refrigeration system and several electric air to air reversible heat pumps are reported in Table 15.4. For these particular climate conditions, the achievable energy savings is equal to 4.6 % over the baseline one if the heat exchanger which matches the two systems acts as de-super-heater for the CO<sub>2</sub>. Otherwise, if it is used as condenser, the solution leads to an increase in global energy consumption in the same order of magnitude<sup>93</sup>.

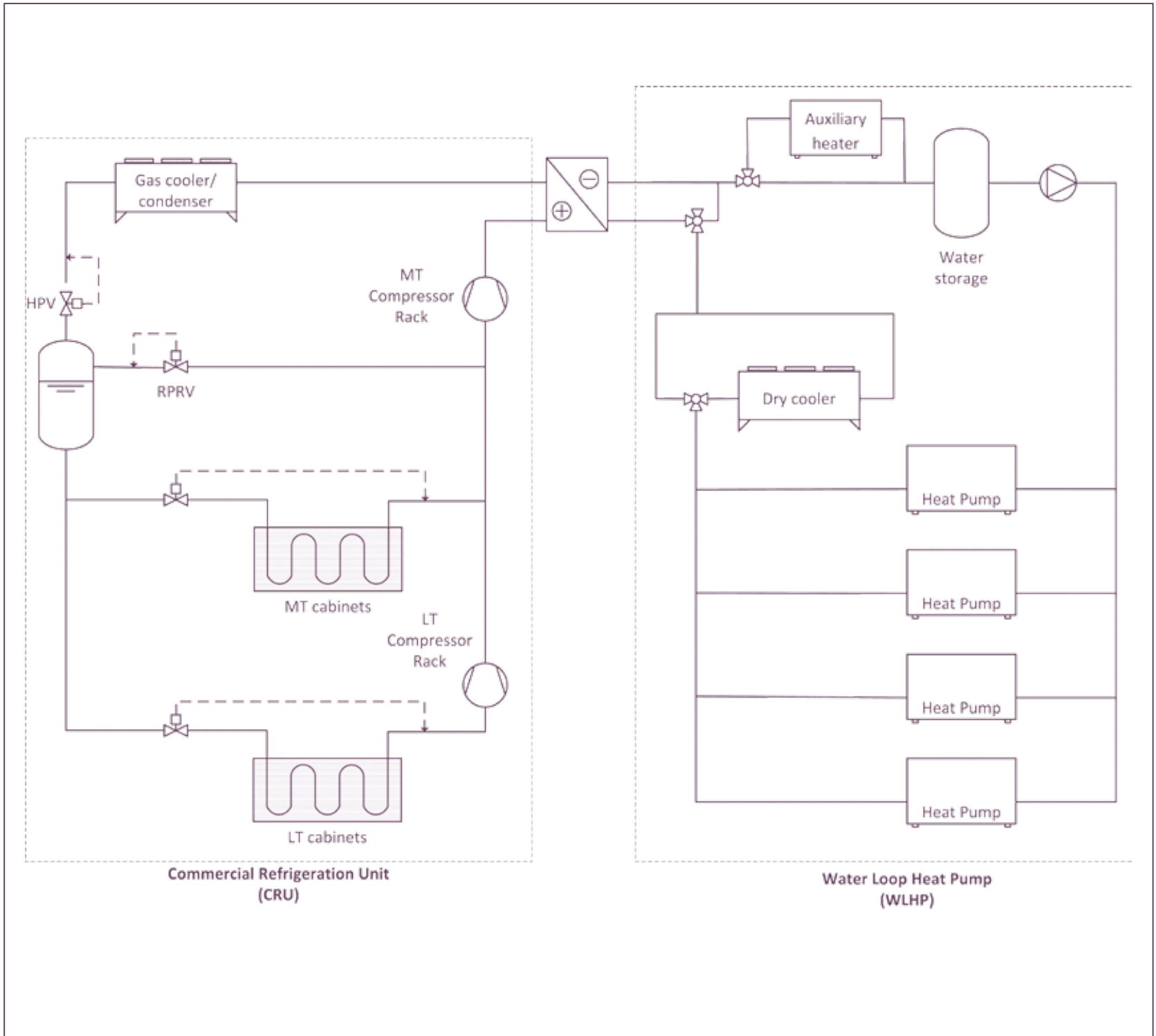
**Table 15.4 - Annual electric energy consumption in “climate A” for water loop heat pump integrated with a booster and energy saving with respect to the baseline.**

	REFRIGERATION [MWH]	HVAC [MWH]	DHW [MWH]	AUXILIARY DEVICES [MWH]	GLOBAL ENERGY SAVING [%]
<b>BASELINE</b>	425.2	142.4	16.8	-	-
<b>WLB-ONLY DE-SUPER-HEATING</b>	393.7	123.1	-	40.6	- 4.6
<b>WLB-CONDENSER</b>	449.0	112.2	-	51.0	+4.7

<sup>92</sup> Buonomano, A., Calise, F., Palombo, A. (2012). Building dynamic simulation: Water loop heat pump systems analysis for European climates. Applied Energy 91, 222-234.

<sup>93</sup> Polzot, A. (2017). Energy benefit assessment of various refrigeration systems integrated with HVAC units in shopping malls, PhD Thesis. University of Udine, Italy.

**Figure 15.10 - Sketch of a CO<sub>2</sub> booster system (CRU) integrated to the water loop heat pump (WLHP).** Source: UNIUD.





## 15.3 APPLY DEMAND-RESPONSE APPROACH FOR REFRIGERATION

About 50% of the electricity in supermarkets is used by the refrigeration system. Demand/Response (D/R) is a managing scheme created to motivate end-use customers to reduce their energy usage at critical times, when energy price or energy demand are at their highest or grid reliability is reduced. During periods when electrical energy and demand prices are high, an advanced weather forecast system is used to shut down the load on the corresponding refrigeration racks. It is based on the presence of a thermal storage system, that can supply the refrigeration during D/R events.

In this case, the thermal storage system can significantly reduce for a defined time, the refrigeration system's energy use during the daytime when the electricity is most expensive and shift this load to off-peak when electricity is less expensive (Figure 15.11).

In this mode, the cooling potential stored in the thermal storage device during the charging mode is used to maintain the desired refrigerator temperature.

Some D/R programmes offer day-ahead notification of events, based on weather and tariff forecasting, allowing facility operators to warn the supermarkets that the temperatures inside the cabinets may be higher on the day of the event.

### Foreseeable scenario and energy costs

D/R is incentive-based, that means the consumers (tenants/owners) reduce their power consumption at times of peak demand or when the system is under stress, in response to changes in electricity prices and/or incentive payments.

There are two approaches for demand-response management in smart grid: direct control and indirect control. In the case of direct control, consumers in a smart grid should follow the power reference sent by the grid in accordance with their storage and consumption limitations. On the other hand, in the indirect approach, consumers receive a real-time price signal from the grid and manage their consumption so that the operating cost in a specific time interval is minimized.

In case of D/R, the network or retail tariffs may support dynamic pricing that must be measured by final customers, such as:

- Time-of-use tariffs;
- Critical-peak pricing;
- Real-time pricing;
- Peak-time rebates.

Depending on the price signals received, the loads are managed to adjust electricity use to minimize operating costs.

### Proposed scenario

Common methods of engaging customers in demand response efforts include offering a retail electricity rate that reflects the time-varying nature of electricity costs or programmes that provide incentives to reduce load at critical times.

Customers who enrol in a programme will receive monthly payments based on the amount of energy they have pledged to reduce and additional payment for the actual load reduced. They also receive free or reduced-cost equipment to improve energy use management.

The customers who want to enrol in a programme must be able to meet its main criteria:

- Event notification period, that is the time the customer must respond to a D/R event;
- Hours per event, that is the length of time during which the customer must ensure the contracted energy consumption reduction in case of a D/R event;
- Max number of events per year;
- Maximum number of hours per year;
- Power provided by customer (MW), that is the amount of contracted power the customer agrees not to use;
- Fixed payment (€/kWyear), that is the financial

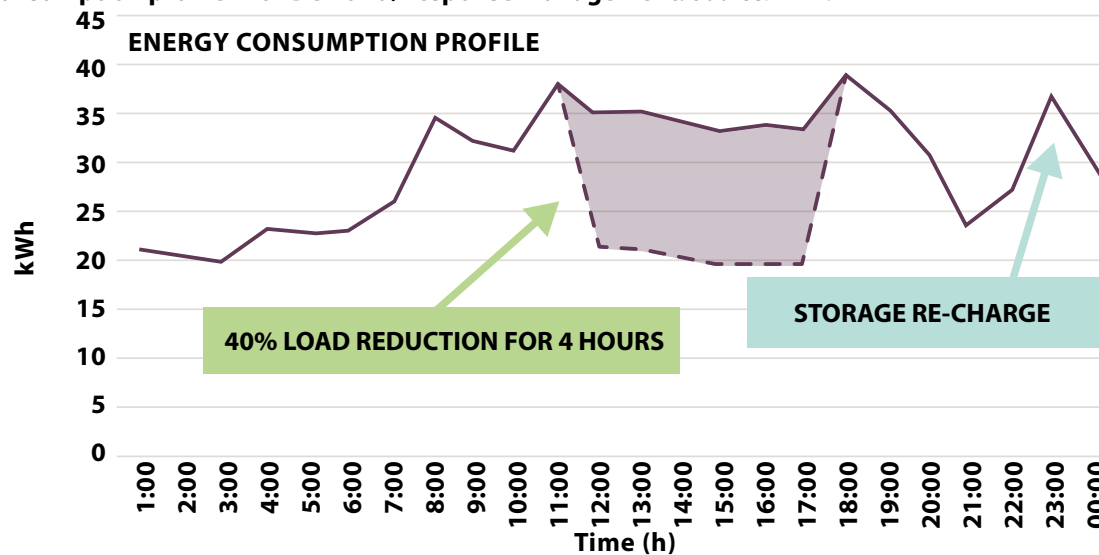
compensation the energy supplier will pay to the customers who ensure the pledged energy consumption reduction;

- Variable payment (€/kWh), that is the economic incentive the energy supplier will pay to the customers at every D/R event;
- Penalties for non-delivery;
- Contract length.



**SOME D/R PROGRAMMES OFFER DAY-AHEAD NOTIFICATION OF EVENTS, BASED ON WEATHER AND TARIFF FORECASTING, ALLOWING FACILITY OPERATORS TO WARN THE SUPERMARKETS THAT THE TEMPERATURES INSIDE THE CABINETS MAY BE HIGHER ON THE DAY OF THE EVENT.**

**Figure 15.11 - Energy consumption profile with Demand/Response management.** Source: EPTA.



## REFERENCES

- Cortella G., D'Agaro P. (2015). Chapter 10: Integration of air conditioning, refrigeration and energy generation in supermarkets, "Sustainable Retail Refrigeration". Ed. J. A. Evans and A. M. Foster, John Wiley & Sons. Chichester, UK.
- Masson N., Jia H., Burkel S. (January 2014). Shecco GUIDE 2014: Natural Refrigerants - Continued Growth & Innovation in Europe. Shecco Publications.
- Finckh O., Schrey R., Wozny M. (2011). Energy and efficiency comparison between standardized HFC and CO<sub>2</sub> transcritical systems for supermarket applications. International Congress of Refrigeration. Prague, Czech Republic.
- Matthiesen O., Madsen K., Mikhailov A. (2010). Evolution of CO<sub>2</sub> systems design based on practical experiences from supermarket installations in northern Europe. 9th IIR Gustav Lorentzen Conference on Natural Working Fluids. Sydney, Australia.
- Sawalha S. (2013). Investigation of Heat Recovery in CO<sub>2</sub> trans-critical solution for supermarket refrigeration. International Journal of Refrigeration, 36, 145-156.
- Polzot, A., Paride G., D'Agaro, P., Cortella, G. (2016). Performance Evaluation of a R744 Booster System for Supermarket Refrigeration, Heating and DHW, In: Proceedings of the 12th IIR Gustav Lorentzen Conference on Natural Refrigerants (GL2016). Edinburgh, UK. Paper 1022.
- Cavallini, A., Corradi, M., Fornasieri, E. (2007). Experimental investigation on the effect of the internal heat exchanger and intercooler effectiveness of the energy performance of a two stage transcritical carbon dioxide cycle. 22nd Int. Congress of Refrigeration. Beijing, China.
- Llopis R, Cabello R, Sanchez D, Torrella E. (2015). Energy improvement of CO<sub>2</sub> transcritical refrigeration cycles using dedicated mechanical subcooling. International Journal of Refrigeration. 55:129-141. DOI: 10.1016/j.ijrefrig.2015.03.016
- Polzot, A., D'Agaro, P., Cortella, G., Gullo, P. (2016). Supermarket refrigeration and air conditioning systems integration via a water storage. In: Proceedings of the 4th IIR International Conference on Sustainability and the Cold Chain. Auckland, New Zealand.
- Polzot, A. (2017). Energy benefit assessment of various refrigeration systems integrated with HVAC units in shopping centres, PhD Thesis. University of Udine, Italy.
- Supermarket application. CO<sub>2</sub> all-in-one transcritical energy pack for HVAC&R integration in small store. Data analysis. Sheehan J. / Mazzola D. / Orlandi M. 12th IIR Gustav Lorentzen Conference on Natural Refrigerants (GL2016). Proceedings. Édimbourg, United Kingdom, August 21st-24th 2016. 2016.08.21-24 - Paper available on <http://www.iifir.org/>
- Supermarket application. Effects of sub-cooling on real R744 based transcritical plants in warm and hot climate. Data analysis. Mazzola D. / Sheehan J. / Bortoluzzi D. / et al. 12th IIR Gustav Lorentzen Conference on Natural Refrigerants (GL2016). Proceedings. Édimbourg, United Kingdom, August 21st-24th 2016. 2016.08.21-24 - Paper available on <http://www.iifir.org/>

## FURTHER READINGS

- Buonomano, A., Calise, F., Palombo, A. (2012). Building dynamic simulation: Water loop heat pump systems analysis for European climates. Applied Energy 91, 222-234.
- Ge Y.T., Tassou S.A. 2011c. Thermodynamic analysis of transcritical CO<sub>2</sub> booster refrigeration systems in supermarket. Energy Conversion and Management 52, 1868-1875
- Hafner A., Hemmingsen A. K., Van de Ven A. (2014). R744 Refrigeration system configurations for supermarkets in warm climates, 3rd IIR International Conference on Sustainability and the Cold Chain. Twickenham, London, UK. 125-133.
- Polzot, A., D'Agaro, P., Cortella, G. (September 11-13, 2016c). Energy analysis of transcritical CO<sub>2</sub> supermarket refrigeration system with heat recovery. In: Proceedings of the 8th International Conference on Sustainability in Energy and Buildings. Turin, Italy.



**Team member working on the iBEMS in Mercado del Val, Valladolid, Spain.** Source: CommONEnergy.

# 16.

## SMART SUPERVISION AND MANAGEMENT

### 16.1 INTELLIGENT BUILDING ENERGY MANAGEMENT SYSTEM (IBEMS)

To achieve results of the retrofit solutions installed and to maintain them over the years, it is important to control the correct functions without reducing the comfort level for the users.

These targets can be obtained following different steps:

**1**

**Install a control system for guaranteeing the proper operation of the solution installed.**

Building Management Systems (BMS) provide effective control functions that allow to improve building functioning.

**2**

**Install an overall Building Management System (BMS) with all sub-systems connected.**

Using a multiple open-protocols communication is possible to integrate different systems with the relative protocols, allowing an access to all data for all sub-systems through a unique platform.

**3**

**Install an Energy monitoring system that provides a support of corrective and preventive action to improve the energy performance of buildings.**

An evolution of the BMS is the BEMS (Building Energy Management System) which integrates the energy consumption data in the building management system, allowing the correlation of the parameters affecting the energy performance.

**4**

**Implement a high-level control logic layer for maximizing the energy efficiency, taking advantage of the interoperability of the sub-systems.**

Interoperability means the ability to cooperate and exchange data with other systems for optimizing the resources. It allows creating a high-level of synergy with different systems, with the aim to offer new functionalities.

In CommONEnergy, we developed an iBEMS (Intelligent Building Energy Management System). It is a comprehensive solution that includes the management of power, lighting, HVAC and refrigeration systems for the entire shopping centre, as well as for the building-correlated services (parking, RES harvesting and local energy production, etc.), with a level of efficiency that involves system dynamics across all applications.

The iBEMS architecture consists of a centralised system which communicates with all sub-systems, which are:

- Daylight System
- Artificial lights
- Shading system
- HVAC system
- Refrigeration
- Solar thermal
- Electrical vehicles
- Hydrogen batteries
- Electrical batteries
- Natural ventilation system

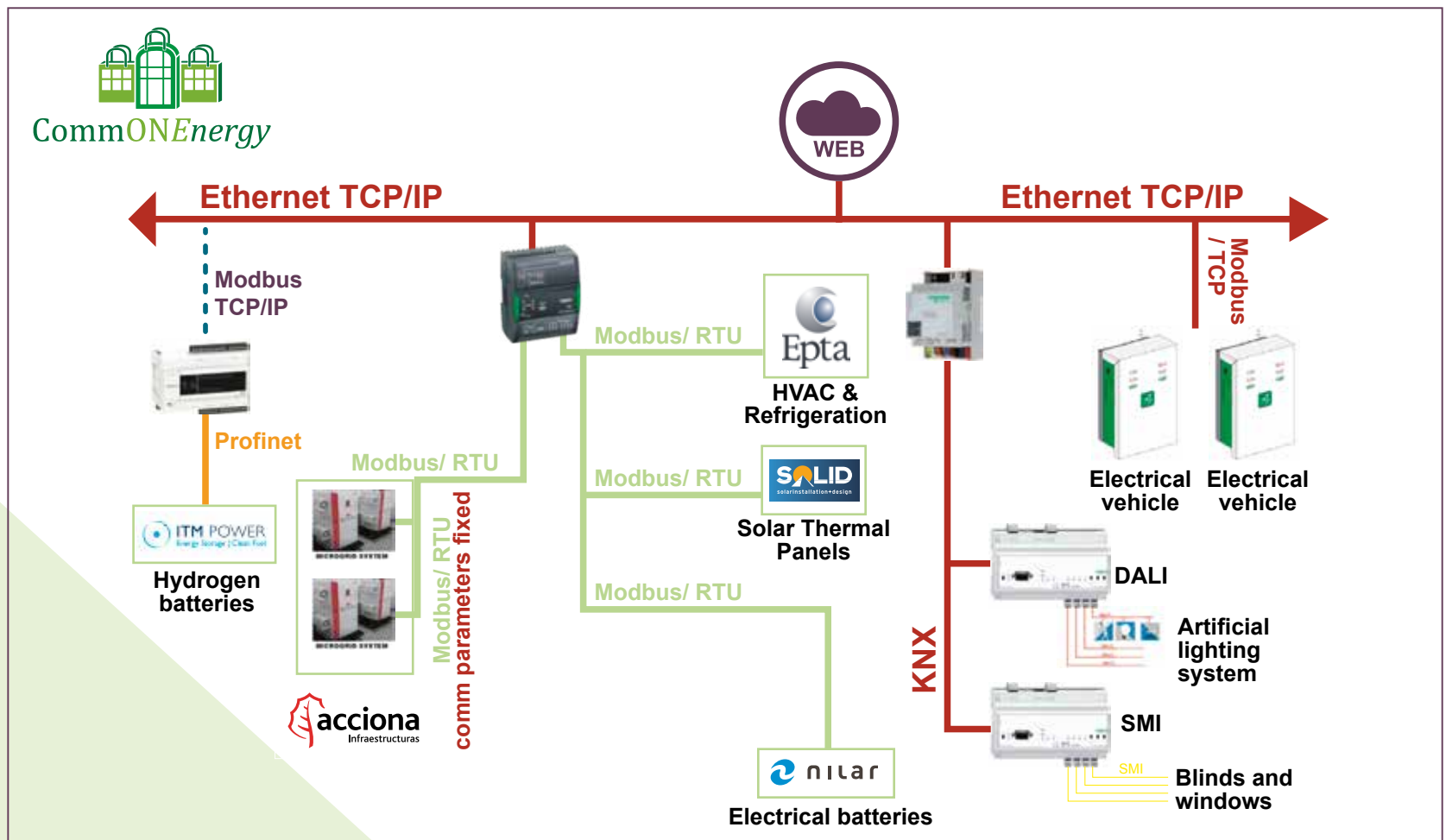
The iBEMS realises the integration of sensors, plants and sub-systems to make the information available to shopping centres' owner, facility manager, energy manager or other key-actors in their management. The solution was realized because all buildings, and especially commercial ones, require a stronger and more efficient collaboration between all the organisation's key stakeholders.

In a shopping centre, the systems' applications installed are communicating with the iBEMS. In parallel, the iBEMS working as a high-level controller allows for instance the energy exchange

between the systems' applications and using the energy losses of one system (refrigeration) as an energy source for another system (HVAC).

In the long-term, the iBEMS creates a report to demonstrate the proper operation of the systems or to identify systems' malfunctions and possible optimisations. Thanks to a continuous monitoring of all systems' operation, the required energy performance is achieved.

### THE ARCHITECTURE OF THE SOLUTION:



Technically, the iBEMS includes the following features:

1. Use of open communication protocols, for data exchange with all various systems installed in a shopping centre and with third-parties using open protocols;
2. Control algorithms as developed and verified with simulation tools to maximize energy savings while improving comfort;
3. Advanced graphical environment to effectively transform monitored data in clear and useful information to show the measurements collected through sensors and meters defined in the Monitoring and Verification Plan;
4. Reporting tool to check whether results meet expectations, that allows to verify if the system is obtaining the expected results and potentially continuously improve the control rules for adapting to the real system.

THE iBEMS SOLUTION CAN CREATE:



**Benefits for Occupants:**

- Good control of internal comfort conditions
- Effective monitoring and targeting of energy consumption
- Improved plant reliability and life
- Effective response to HVAC-related complaints
- Time and money saved during the maintenance



**Benefits for Building Owners:**

- Higher property value
- Remote monitoring of equipment and plants like plumbing pumps, electrical supply, fire pumps and more
- Increased level of comfort
- Central remote control of building
- Monitoring of building



**Benefits for Maintenance Companies:**

- Satisfied occupants
- Computerised maintenance schedules
- Effective use of staff for maintenance
- Ease of information availability

The iBEMS fulfills the requirements of the EN15232 standard allowing to reach the class A in the Building Automation energy efficiency.



IN COMMONENERGY, WE DEVELOPED AN iBEMS (INTELLIGENT BUILDING ENERGY MANAGEMENT SYSTEM) AS A COMPREHENSIVE SOLUTION THAT INCLUDES THE MANAGEMENT OF POWER, LIGHTING, HVAC AND REFRIGERATION SYSTEMS FOR THE ENTIRE SHOPPING CENTRE, AS WELL AS FOR THE BUILDING-CORRELATED SERVICES.

## 16.2 CONTINUOUS COMMISSIONING (CC) PLATFORM PROCEDURE

This procedure aims to identify a standard method to characterize the performance of the building on comfort, energy and economic aspects, using the Continuous Commissioning (CC) procedure.



THE CC IS “AN ONGOING PROCESS TO RESOLVE OPERATING PROBLEMS, IMPROVE COMFORTS, OPTIMIZE ENERGY USE, AND IDENTIFY RETROFITTING DRIVERS FOR EXISTING COMMERCIAL AND INSTITUTIONAL BUILDINGS, AND CENTRAL PLANT FACILITIES”<sup>94</sup>

It is composed by two main phases: the first one in which, after defining a project scope, an audit of the building is carried out together with a CC plan. In the second phase, the CC measures identified in the first step are implemented. The latter phase includes important points, such as conduct system measurements, developing performance baselines, implementing CC measures, documenting comfort improvements and energy/economic savings and keeping the commissioning continuous.

The determined performances of the building are compared with on one hand, the intended performances of the analysed commercial centre on the designed phase and, on the other hand, on the performances of other buildings (benchmark). Moreover, the long-term energy and comfort records are used by the energy manager or by the maintenance team to:

1. Fault detection. The measured data of thermal or electrical consumption together with a definition of proper Key Performance Indicators (KPIs) could help check possible component failures. If a marginal variation (increase, decrease) of energy consumption is showed, a problem solving should be started.
2. System optimization. Improving the control of systems if needed;
3. Calculate the real energy savings or comfort improvements.

As a first step, the process starts with a clear definition of the commissioning scope (i.e. reducing energy consumption, optimizing a specific system, improving indoor comfort, etc.) and the available budget. After this, the energy audit of the commercial building is carried out. The engineer must gather all possible information useful to document the energy performance of the heating, cooling, HVAC, refrigeration and electrical system as well as building features.

The goal of the second step is to identify the actual comfort and building energy performance and to develop a model that represents the baseline of the building energy consumption. A detailed documentation about system features is carried out, evaluating both mechanical and control system or components through the installation of a monitoring system. This should collect data

of thermal, electrical and Indoor Environmental Quality (IEQ) conditions. A detailed list of measurement points is required. The scope is to eliminate two main problems on building analysis: 1) the lack of data useful to evaluate the building performance, 2) the installation of useless sensors which data are never used for the analysis.

Concerning the resolution of data, it could change accordingly to the aim of the commissioning process. If the identification of faults is required, the time step should be lower than possible (e.g. 2,5 or 10 minutes); on the contrary, if the purposes are the evaluation of the energy savings of the whole building or documentation of indoor comfort, the resolution of data could be high (from 30 minutes to monthly).

If the aim of the commissioning is to save energy, the definition of a baseline is necessary. The measurements should follow the methodology defined both by ASHRAE guideline 14-2002<sup>95</sup> or the International Performance Measurements and Verification Protocol (IPMVP)<sup>96</sup>. In these methods, “the energy savings are determined by comparing the measured use or demand before and after the implementation of a program, making suitable adjustment for changes in condition”.

It means that the evaluation of the real energy savings could be carried out only if outside independent variables (e.g. weather, occupancy, etc.) are taken into account as normalization factor of the energy data. Typically, there are three main general approaches to assess savings:

1. Whole building: comparison of adjusted pre/post whole building consumptions, applied when more measures are implemented;
2. Retrofit/intervention isolation: uses a meter to isolate the consumption of the sub-system that received the intervention;

<sup>94</sup> Liu M., Claridge D.E., Turner W.D. (2002). Continuous CommissioningSM Guidebook.

<sup>95</sup> Haberl J.S., Culp C., Claridge D.E. (2005). ASHRAE's GUIDELINE 14-2002 for measurement of energy and demand savings: how to determine what was really saved by the retrofit.

<sup>96</sup> U.S. Department of Energy. (March 2002). International Performance Measurement and Verification Protocol Concepts and Options for Determining Energy and Water Savings - Volume I.

- Whole building calibrated simulation: using a simulation tool to create a model and to calibrate it with measures of energy use (e.g. electrical, thermal bills). The prediction from this model is then compared with the post-intervention energy consumption. This is used when pre-intervention measured data are not available.

The approaches proposed for shopping centres are the first and second ones. In those cases, the IPMVP procedure basically consists in projecting energy consumption on post-intervention (reporting) period, based on the relationship among variables estimated during the pre-intervention (baseline) period. This extrapolation requires the characterization of the relationship among consumption and independent variables previously appointed.

Finally, by subtraction from the project consumption (after implementation of Energy Conservation Measures - ECM), if no intervention occurred (estimated from the mathematical relationship derived during the baseline period) and the monitored energy consumption (before implementation of ECM), the savings associated with the intervention are quantified. Like this, energy savings can be considered as avoided energy use, since if the intervention had not taken place, the energy consumption would be as calculated (Figure 16.1).

At the basis of this task, there is data reliability. This is why, after the installation of a Data Acquisition System (DAS) based on the list of measurement points, the quality control of data is carried out. The quality control has the scope to estimate the uncertainty of the installed sensors. The sensors are highly sensitive to matrix effects, meteorological conditions, and gaseous interferences that change from site to site. Commonly, the validation performed by sensor users consists in establishing

the minimum set parameters to describe sensor sensitivity and stability. These parameters are generally defined by the sensor producer and indicated in the product datasheet<sup>97</sup>.

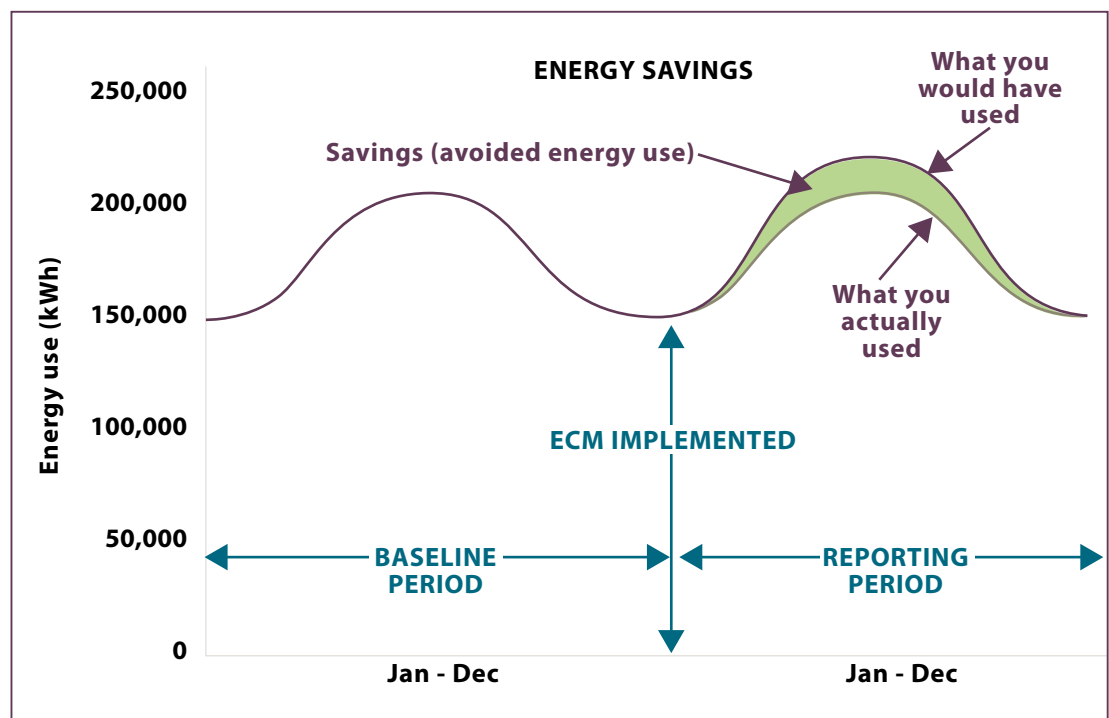
As a third step, the analysis of the monitored data is carried out. The findings are useful to :

- Identify possible faults on heating, cooling, electrical and ventilation systems;
- Define a list of possible solutions based on point 1;
- Develop or optimize control strategies;
- Identify the possible energy and economic savings as well as IEQ improvements.

As described, the data collected is related to different systems (e.g., heating and cooling system, HVAC, etc.) with a large part of them needed to be monitored and managed in real time. Different dynamic conditions, inside and outside the buildings, influence and play a role in the appropriate control settings and actuation.

Additionally, several constraints must be satisfied to guarantee a good indoor comfort together with best energy consumption. For this reason, all four points described above and particularly the development and optimization control strategies have a great impact in the building energy consumption and system performance.

**Figure 16.1 - Explanatory Diagram of energy conservation measure (ECM) savings.** Source: ASHRAE's GUIDELINE 14-2002<sup>98</sup>.



<sup>97</sup> Antonucci D., Manni A., Grottko M., Noris F. (2015). Guidelines for energy monitoring and control in public buildings - SmartBuild project.

<sup>98</sup> Haberl J.S., Culp C., Claridge D.E. (2005). ASHRAE's GUIDELINE 14-2002 for measurement of energy and demand savings: how to determine what was really saved by the retrofit.



In the fourth step, among the list of possible ECMs, the possible ones are presented to the owner and applied on the building. The ECM have to face control and comfort issues. As first solutions, the modification of system control strategies and comfort-improving measures are considered. Solving these problems increases the satisfaction of occupants and cooperation from staff, as well as leads to energy and cost savings.

In the fifth step, the comfort improvements together with energy and cost savings are documented. As indicated in step two, this task needs the definition of the baseline and, in particular, of a building model that could explain the performance of the building also in the reporting period if no

ECM would be implemented. The type of model is generally a simple equation that characterizes a specific building output, such as the energy or electrical consumption, indoor temperature, etc. At the basis of all possible models, there is a need to normalize or correlate the output data with independent variables, so that the model could be used in the reporting period to calculate the energy savings. A simple example of linear model is the regression of energy consumption with the external temperature if the annual projection derived from short-term data.

The identified model could also be used to forecast a selected output and optimize the control according to results. In the case when a

Building Management System (BMS) is installed in the commercial centre, an automated procedure of forecast and optimization could be applied.

The process illustrated so far evaluates the performance of the building before and after the implementation of the ECM. Another important approach is to compare the building performance with other similar buildings. To do this, the data need to be normalized according to several factors, such as the external temperature, occupancy, level of indoor thermal and visual comfort.

In CommONEnergy, specific KPIs were defined for each sub-system, both mechanical and electrical, taking into account all factors defined before (see example in figure 16.2).

**Figure 16.2 - Example of KPI to evaluate the heating and cooling demand.**

$$Q_t^{\text{norm}} = \begin{cases} \frac{Q_t * f_t^{\text{Occ}}}{A * f_t^{\text{HDD}} * I_t^{\text{TC(av)}} \text{ (or } I_{t_{nv}}^{\text{TC(av)}})} & \text{if heating} \\ \frac{Q_t}{A * f_t^{\text{CDD}} * f_t^{\text{Occ}} * I_t^{\text{TC(av)}} \text{ (or } I_{t_{nv}}^{\text{TC(av)}})} & \text{if cooling} \end{cases} \left[ \frac{\text{kWh}}{\text{m}^2} \right]$$

$$Q^{\text{norm}} = \sum_{t=1}^n Q_t^{\text{norm}}$$

$Q_t^{\text{norm}}$  : Normalized energy for heating and cooling at time t [kWh/m<sup>2</sup>]

$Q^{\text{norm}}$  : Total normalized energy for heating and cooling [kWh/m<sup>2</sup>]

$n$  : Number of time points

$f_t^{\text{HDD/CDD}}$  : Heating or Cooling Degree Day factor at time t [-]

$f_t^{\text{Occ}}$  : Occupancy factor at time t [-]

$A$  : Area of heated space [m<sup>2</sup>]

$I_t^{\text{TC(av)}}$  : Average value of thermal comfort indexes [0.01, 1] in case of mechanical ventilation.

Dealing with economic aspects, other factors need to be considered. Indeed, as indicated in [5] “when energy costs are compared between two buildings that have been analysed at different times or in different places, several factors may bias the comparison:

- changes in energy prices over time;
- differences in energy prices from place to place;
- general inflation that occurs during the time interval;
- exchange rates between different currency units, which vary over time.”

The last step of the CC process aims to keep the commissioning continuous, maintaining both energy and IEQ aspects at the appropriate level and monitoring all the time the performance of the building. This work could be done only if a specific tool is used.

In *CommONEnergy*, a specific tool for CC, which considers all aspects illustrated in the previous steps, is developed. More information about the tool can be found in the report “Supervision Software for Continuous Commissioning”<sup>99</sup>.



**IN COMMONENERGY, A SPECIFIC TOOL FOR CC, WHICH CONSIDERS ALL ASPECTS ILLUSTRATED IN THE PREVIOUS STEPS, IS DEVELOPED. MORE INFORMATION ABOUT THE TOOL CAN BE FOUND IN THE REPORT “SUPERVISION SOFTWARE FOR CONTINUOUS COMMISSIONING”.**

<sup>99</sup> Antonucci D., Pasut W. (2017). Supervision Software for Continuous Commissioning. [http://commonenergyproject.eu/uploads/deliverable/file/26/WP5\\_D5.5\\_20170125\\_P01\\_Supervision\\_software\\_for\\_continuous\\_commissioning\\_NotPrintable.pdf](http://commonenergyproject.eu/uploads/deliverable/file/26/WP5_D5.5_20170125_P01_Supervision_software_for_continuous_commissioning_NotPrintable.pdf)

## REFERENCES

Liu M., Claridge D.E., Turner W.D. (2002). Continuous Commissioning SM Guidebook.

Haberl J.S., Culp C., Claridge D.E. (2005). ASHRAE’s GUIDELINE 14-2002 for measurement of energy and demand savings: how to determine what was really saved by the retrofit.

US Department of Energy. (March 2002). International Performance Measurement and Verification Protocol Concepts and Options for Determining Energy and Water Savings – Volume I.

Antonucci D., Manni A., Grottko M., Noris F. (2015). Guidelines for energy monitoring and control in public buildings - SmartBuild project.

Bareley D., Deru M., Pless S., Torcellini P. (October 2005). Procedure for measuring and reporting commercial building energy performance.

Antonucci D., Pasut W. (2017). Supervision Software for Continuous Commissioning. [http://commonenergyproject.eu/uploads/deliverable/file/26/WP5\\_D5.5\\_20170125\\_P01\\_Supervision\\_software\\_for\\_continuous\\_commissioning\\_NotPrintable.pdf](http://commonenergyproject.eu/uploads/deliverable/file/26/WP5_D5.5_20170125_P01_Supervision_software_for_continuous_commissioning_NotPrintable.pdf)



**E-vehicle charging station in Grosseto Maremà, Italy.** Source: CommONEnergy.



# 17.

## LOCAL ENERGY GENERATION, GRID INTERACTION AND STORAGE

### 17.1 RES EXPLOITATION

The electricity market is changing from a centralized-passive-system to a decentralized and active network, characterized by an increase in Renewable Energy Generation (RES) and active loads, such as Energy Storage System (ESS) and Electrical Vehicles (EVs). The increase of energy prices, combined with the need to reduce CO<sub>2</sub> emissions, incentivise the penetration of RES not only at utility scale but also at building level.

In this context, the shopping centre shows favourable features for the installation of RES. Its location and the weather conditions also impact on variable renewable generators, such as wind turbine and photovoltaic (PV) systems. In order to effectively install a wind turbine, the shopping centre must have a geographical position where the wind presence is guaranteed for most of the year. In addition, it should be possibly far from an urban context, to avoid that neighbouring buildings interfere with the wind diffusion.

Differently, the PV generation has less strict requirements and results as the most scalable and applicable type of renewable energy, even the most diffuse in European buildings. The weather conditions are relevant for PV systems as well, as a certain number of solar hours need to be guaranteed. Position and integration aspects are however easier. The modular nature of PV systems allows to install the modules in different areas, like shopping centres roof, car park shave canopies, integrated on façade through BIPV (Building Integrated Photovoltaic). The

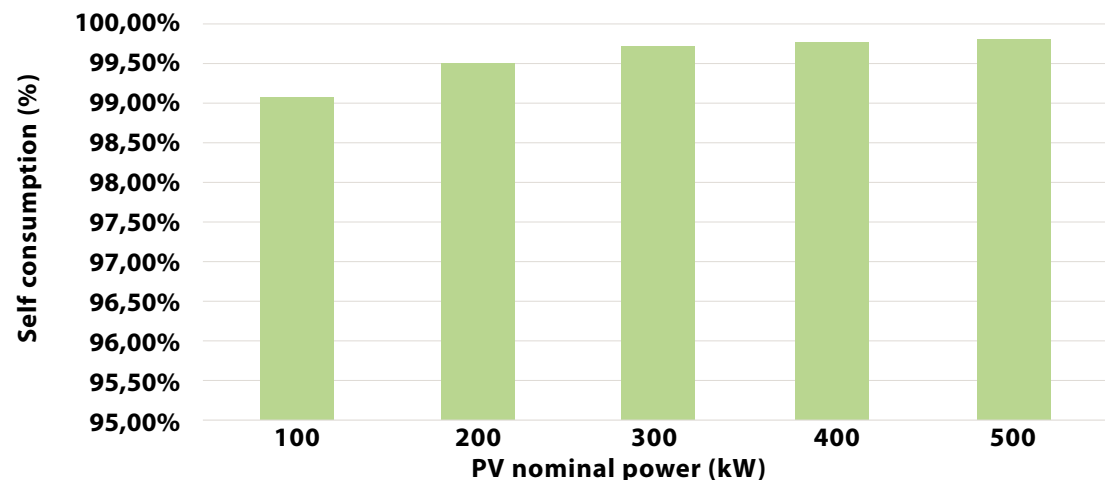
PV systems have also several advantages associated to low maintenance costs (around 1%/year), long effective life (i.e. usually >20 years), high reliability and rapid output response to incident radiation changes.

Additional RES applications for shopping centres are solar thermal and Combined Heat and Power (CHP) systems. For solar thermal systems, the most diffuse types of collectors are flat plate ones. They are used for domestic hot water and space heating, as well as process-heat applications with temperature levels up to 95°C. In addition, solar thermal heat can be used to drive a thermal cooling machine and therefore as energy source for cooling. In many applications, collectors are placed either on flat roofs or on top of pitched roofs. However, building integration of collectors are expected to become more common, either on roof or façade. Regarding the clean energy sources from CHP systems, the use of heat for

cogeneration can reach 90%, with a primary energy saving reduction of approximately 40%, compared to a separate purchase of electricity for heating coming from utility grid and gas boiler.

Considering the large electric and thermal demand of shopping centres, the biggest part of the energy produced by RES is consumed directly on-site. This is mainly because most part is used during opening hours, usually ranging between 09:00 and 21:00. The PV production, for example, is maxima during late morning and early afternoon hours. When evaluating the self-consumption index, representing the energy consumed on-site versus the energy produced by PV, it reaches about 100%. Figure 17.1 reports an example of self-consumption behaviour for the CommONEnergy reference case in Genova (Italy) over different PV nominal power.

**Figure 17.1 - Self-consumption behaviour over PV nominal power of Genova supermarket (Italy).** Source: EURAC.



The energy demand combined with the available surface determines use and installation of a PV system. If the PV production covers a lower energy demand than the whole shopping centre consumption, an ESS can be installed to maximally exploit the RES generation. Battery Energy Storage System (BESS) can store the surplus of PV generation, as previously mentioned, or charge from the grid during night hours (when the electricity price is lower) and use the energy for different applications:

- Increase self-consumption;
- Shave peak consumption;
- Electrical load matching;
- Support grid operations.

A proper PV and BESS management is operated by the intelligent Building Energy Management Systems (iBEMS). Parametric simulations performed in CommONEnergy and presented in the EUPVSEC

exhibition<sup>100</sup> show how the use of BESS combined with PVs increase the self-consumption and self-production of PV generation proportionally with the size of installed battery, leading also to a CO<sub>2</sub> emission reduction. Figure 17.2 reports a typical trend of self-consumption, self-production and CO<sub>2</sub> emissions, considering a shopping centre with reduced energy consumption.

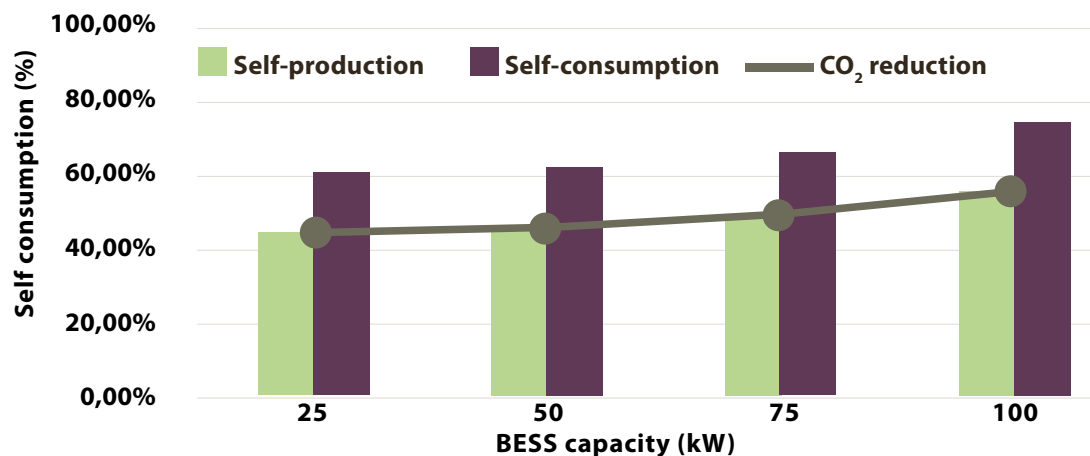
From an economic point of view, the advantages of PV-BESS strictly depend on the country and electricity price. In Italy, the electricity price varies during the day, usually over three different tariffs not showing a big difference among them. Moreover, currently (2017), for PV system with nominal power lower than 500 kWp, there is a net-billing scheme which consists in monetarising the PV energy injected into the grid. These two aspects, together with the large energy consumption, make the use of BESS for self-consumption only, not so advantageous in Italy. However, the BESS installation becomes

economically competitive when the energy demand is lower, the consumption and generation are not simultaneous, or in absence of the net-billing rule<sup>101</sup>.

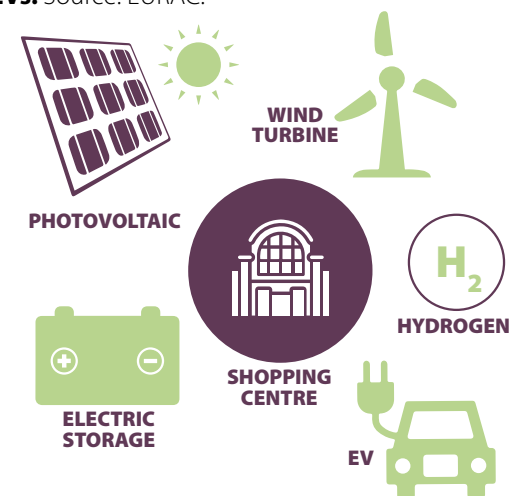
The BESS can also be applied also to shave the consumption peak during hours when the energy demand or the electricity cost is high. This leads to save money and support stability and quality of the electricity service<sup>102</sup>. An interesting application of PV-BESS to supply electric mobility is described in the next chapter.

Beyond battery, the hydrogen technology should have interesting application in shopping centres. The large available space can be used to install a hydrogen electrolyser, which, supplied by PV overproduction, produces hydrogen for different applications, such as refuel for hydrogen car or fork lift or for heating<sup>103</sup>. More details and a feasibility study are reported in "Batteries with management control system"<sup>104</sup>.

**Figure 17.2 - Typical trend for self-consumption, self-production and CO<sub>2</sub> reduction in presence of PVs and BES covering the lighting consumption of a supermarket.** Source: EURAC.



**Figure 17.3 - Possible RES exploitation in shopping centres considering storage and EVs.** Source: EURAC.



<sup>100</sup> Barchi G, Lollini R, Moser D. (June 2016). Photovoltaic and Battery Energy Storage Systems in Shopping Malls: Energy and Cost Analysis of an Italian Case Study. European PV Solar Energy and Exhibition (EUPVSEC 2016). Munich, Germany. 20-14.

<sup>101</sup> Barchi G, Lollini R, Moser D. (June 2016). Photovoltaic and Battery Energy Storage Systems in Shopping Malls: Energy and Cost Analysis of an Italian Case Study. European PV Solar Energy and Exhibition (EUPVSEC 2016). Munich, Germany. 20-14.

<sup>102</sup> <http://www.nilar.com/>

<sup>103</sup> <http://www.itm-power.com/>

<sup>104</sup> Batteries with management control system. EU FP7 CommONEnergy project. [Online] <http://commonenergyproject.eu/resources/deliverables>

## 17.2 ELECTRIC MOBILITY

Electric-powered vehicles (EVs) offer a significant potential in efficiency improvements and CO<sub>2</sub> reductions for the transport sector. EVs are particularly relevant in shopping centres, where the Green House Gas (GHG) emissions are high due to the carbon footprint of the shopping centre itself and the transports involved in reaching them.

There are mainly two types of EVs: Battery Electric Vehicles (BEVs) or Fuel Cell Electric Vehicles (FCEVs). A further difference depends on their charging method or whether they have an external range extender. Plug-in hybrid electric vehicles (PHEVs) contain rechargeable batteries, charged using common power sockets. BEVs exploit the energy stored in the battery chemical compartments to give power to the electric engines. Although power is provided to the car by the electric engine, the main barrier is the limited range of battery capacity<sup>105</sup>.

The driving experience with BEVs or FCEVs is similar; however, the refuelling experience is distinct: the BEVs require a long period to fully recharge (usually hours) while the FCEVs are designed to be completely refuelled in few minutes in order to equal the refuelling time of petrol/diesel cars. Either cases show opportunities to provide shopping centres with green mobility options. For both types of electric vehicles, the energy source can be the electricity grid, with BEV

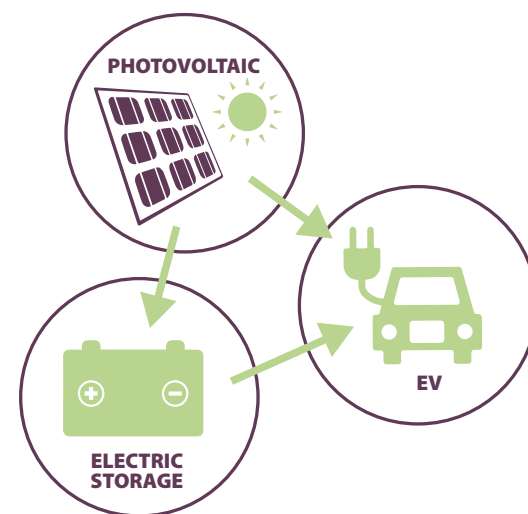
recharging points and hydrogen refuelling stations based on electrolyzers located at the centre. In many countries, the refuelling of petrol/diesel cars is commonplace in shopping centres, so these relatively new green mobility options may be considered as additional to conventional practice in the early years but ultimately the solutions for future transport. Note that while both BEVs and FCEVs have zero emissions at the tail pipe, the overall emissions are based heavily on the carbon intensity of the electricity used. This varies both on country and on any renewable source used.

Related to the last point, using a renewable and sustainable system composed of photovoltaics and battery (PV-BES) is a great opportunity for shopping centres to provide electricity for EVs. Several European countries are encouraging the EV diffusion thanks to EV-link installation. In this context, shopping centres, usually consisting of large parking areas, become relevant sites.

Assuming to have forecasts or statistics of daily access to Electrical Vehicle link (EV-link), it is possible to measure the size of the PV system and the battery storage capacity in order to cover most part of the demand by the PV-BES system. Different electrical configurations could be adopted, but, since it is necessary to guarantee the supply service, it is recommended to have the PV-BES connected to the grid. The iBEMS manage the energy flows produced by PVs and stored into the

battery through proper control rules. The system gives priority to the EV demand that can be directly covered by PVs (in presence of sunny day) or by BES charged with PV production. The image below summarizes the concept.

**Figure 17.4 - Simplified representation of PV-BES for electric mobility.** Source: EURAC.



A pilot case was developed by CommONEnergy and installed in the Marema' shopping centre in Grosseto (Italy), where a nickel metal-hybrid (NiMH) battery designed by Nilar<sup>106</sup> was installed. The NiMH technology has several advantages, like being sustainable and environmentally friendly.



ELECTRIC-POWERED VEHICLES (EVs) OFFER A SIGNIFICANT POTENTIAL IN EFFICIENCY IMPROVEMENTS AND CO<sub>2</sub> REDUCTIONS FOR THE TRANSPORT SECTOR.

<sup>105</sup> Scenarios and solutions for shopping mall energy grid. (2017). CommONEnergy project. [http://commonenergyproject.eu/uploads/deliverable/file/54/WP4\\_D4.5\\_20170120\\_P03\\_Scenarios\\_and\\_solutions\\_for\\_shopping\\_mall\\_energy\\_grid\\_NotPrintable.pdf](http://commonenergyproject.eu/uploads/deliverable/file/54/WP4_D4.5_20170120_P03_Scenarios_and_solutions_for_shopping_mall_energy_grid_NotPrintable.pdf)

<sup>106</sup> <http://www.nilar.com/>



Lifecycle of a building. Source: Fraunhofer IBP.

# 18.

## IMPACT ASSESSMENT

CommONEnergy focuses on reducing the energy consumption of EU shopping centres by developing smart retrofitting strategies and solutions. The big challenge is to provide sustainable options that are also cost-effective, with an acceptable payback period. In order to gain an understanding of the cost-effectiveness of retrofitting measures in shopping centres in the EU28 and Norway, an economic assessment tool<sup>107</sup> was developed.

The Economic Assessment Tool aims at showing the costs and benefits of investing in the retrofitting solutions and contributing to the achievements of the EU and national environmental and energy goals. The Economic Assessment Tool is a convenient and useful instrument to estimate the energy saving potential and economic benefits of retrofitting shopping centres.

The main features of the tool are:

- It provides quick information on the energy consumption and options to reduce energy demand, CO<sub>2</sub>-emissions and environmental impact, and provides an economic assessment of the investments;
- It gives information on the retrofit solutions developed by the project industry partners and their implementation;
- It works as online-tool with the possibility to get the results in pdf format;
- It can be applied to shopping centres located in the EU28 and Norway;
- It targets construction managers and owners of the shopping centre.

Several retrofitting solutions show potential areas of improvement, benefits and energy savings. However, the tool does not replace a detailed analysis made by an expert.

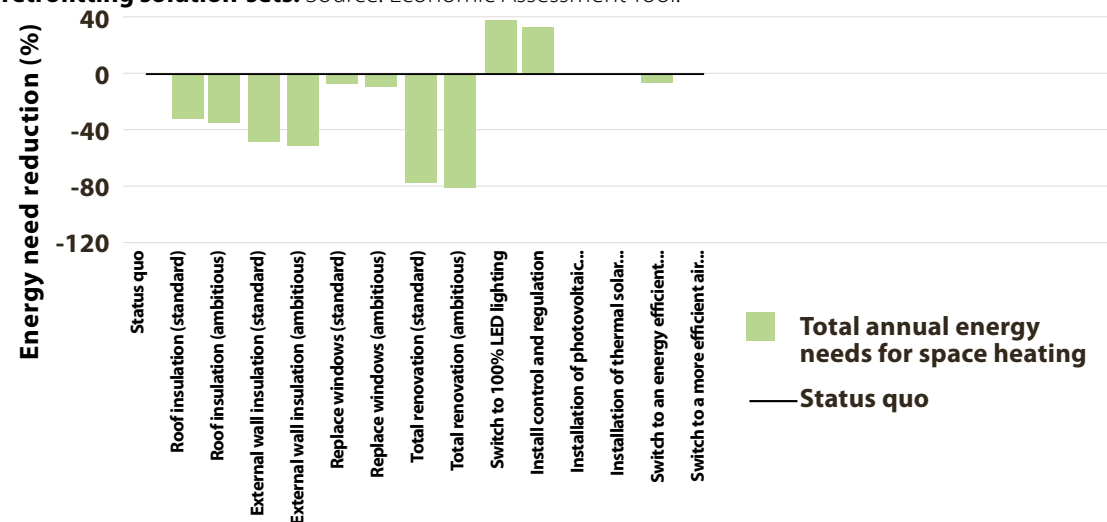
The model can be applied for a specific shopping centre building, described by the user. Building description covers several technical parameters such as geometry, construction period, HVAC parameters and location. The calculation of the economic feasibility of the solutions is based on a disaggregated level of data. The data is provided partly by the user (directly in the tool) and partly by the model from the database.

The model consists of the user interface (including database) and method modules. The first one requires the user to describe building-specific data (through mandatory input and drop-down menu) and evaluate model outcomes on energy and financial performance of retrofit packages. The output field gives the results

on energy and financial performance of the retrofit packages, presented in the form of bar charts and table sheets. The analysis is made and presented for 10 retrofit solutions covering insulation of the building elements (roof, windows, external walls), LED lighting installation, control and regulation systems for lighting, installation of photovoltaic system, installation of thermal solar system, installation of energy efficiency refrigeration system and finally more efficient air conditioning systems. All solutions are compared and ranked according to energy and financial performances (see Figure 18.1). Techno-economic calculation is carried out by using the building simulation tool Invert-EE/Lab. Energy demand for space heating, cooling and lighting is calculated using a monthly-based energy balance approach, according to EN13790.

The building stock retrofitting in terms of energy supply and efficiency is one of the major challenges

**Figure 18.1 - Model results showing energy need reduction by implementing different retrofitting solution-sets.** Source: Economic Assessment Tool.<sup>108</sup>



<sup>107</sup> [http://commonenergyproject.eu/eco\\_assessment\\_tool.html](http://commonenergyproject.eu/eco_assessment_tool.html)

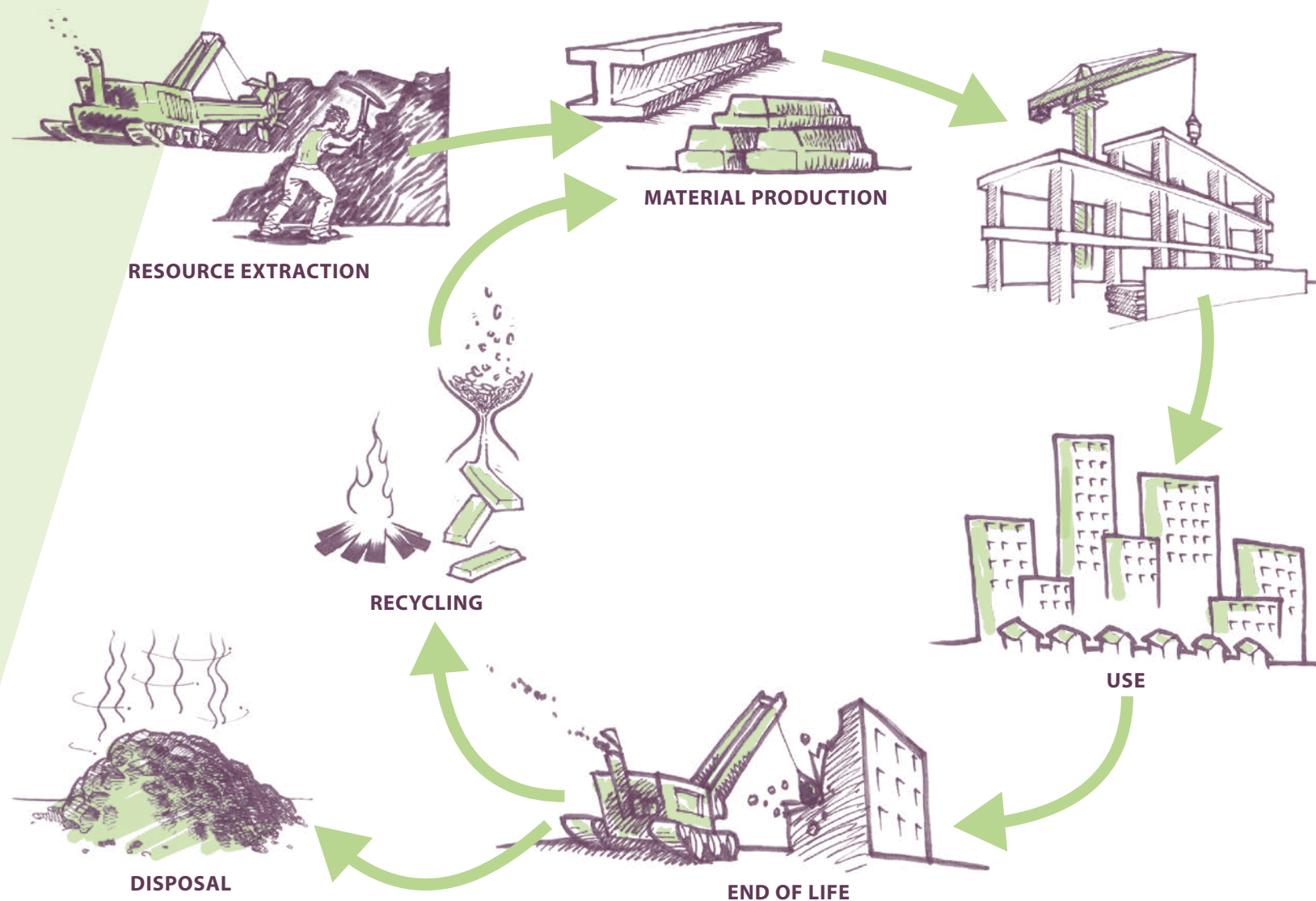
<sup>108</sup> [http://eeg.tuwien.ac.at/commonenergy\\_economic\\_assessment\\_tool/#page=input\\_group1&reload=false](http://eeg.tuwien.ac.at/commonenergy_economic_assessment_tool/#page=input_group1&reload=false)



## 18.1 ASSESSMENT OF THE ENVIRONMENTAL IMPACT

in Europe. The environmental impact of the energy supply systems is not the sole focus of interest in the optimisation of the whole system. In addition, the environmental impact of the production of materials e.g. insulation and End-of-Life (EOL) are also important. In order to assess the environmental impact over the entire lifecycle of a building, the standardized method of the Life Cycle Assessment serves as basis for calculation [ISO14040<sup>109</sup>] [ISO14044<sup>110</sup>] [EN15978<sup>111</sup>] [EN15804<sup>112</sup>] [ILCD Handbook<sup>113</sup>].

**Figure 18.2 - Lifecycle of a building.** Source: Fraunhofer IBP.



<sup>109</sup> ISO 14040 Environmental management – Life cycle assessment – Principles and framework.

<sup>110</sup> ISO 14044 Environmental management – Life cycle assessment – Requirements and guidelines

<sup>111</sup> EN 15978: Sustainability of construction works – Sustainability assessment of buildings – calculation method. CEN – European Committee for Standardization. Brussels: CEN – CENELEC 2010.

<sup>112</sup> EN 15804: Sustainability of construction works – Environmental product declarations – Core rules for the product category of building products. CEN – European Committee for Standardization. Brussels: CEN – CENELEC 2011.

<sup>113</sup> European Commission – Joint Research Centre – Institute for Environment and Sustainability (Ed.). (2010). ILCD Handbook. General guide for life cycle assessment: detailed guidance. First edition. Luxembourg: Publications Office of the European Union. ISBN: 978-92-79-19092-6.

Within CommONEnergy, the environmental impact of 9 shopping centres was analysed in detail (e.g. global warming potential). The Life Cycle Assessment of the shopping centres shows the highest impact results from the energy consumption for space conditioning (heating, cooling, ventilation), lighting, refrigeration and appliances. Hence, the utilization phase of shopping centres represents in most cases the lifecycle stage with the highest impacts and, therefore, with the biggest optimization potential.

The internal loads of waste heat from lighting, refrigeration and appliances are especially critical, as they need to be removed with cooling. In these cases, the shares of environmental impact emerging from the production and End-of-Life (EOL) phases of the retrofitting materials are of minor interest.

In order to reduce the environmental impact of shopping centres with retrofitting measures, the following important aspects should be considered.

### **18.1.1 OPTIMIZATION OF THE USE PHASE**

The environmental impact, including global warming potential and non-renewable primary energy demand is mainly influenced by shopping centres energy consumption. The first optimization shall therefore address the use phase and thereby the energy production and demand of the shopping centre. The following issues should be considered:

#### **Reducing energy demand by use of passive strategies**

Passive technologies like natural ventilation are beneficial for the reduction of the overall environmental impact, as well as the optimization of controls (e.g. prevention of inefficiencies). Thus, without any additional material, huge energy savings can be achieved regarding lighting, heating and cooling. Due to the minimal amount of material and resource consumption and the major impact of environmental savings, these solutions should be immediately implemented.

#### **Adaptation of the comfort levels**

The detailed analysis of comfort (thermal and visual) and its adaptation, in contrast to the conditions mentioned in the standards, can lead to large energy savings (e.g. adapted temperature level in common areas). Especially lighting adaptation regarding can lead to huge energy savings and, consequently, to a reduction of the environmental impact.

#### **Increase the efficiency of active components (e.g. technical equipment)**

Depending on the age of the Heating, Ventilation and Air Conditioning (HVAC) system, improvements in terms of energy efficiency can be achieved with little and uncritical materials (e.g. new more efficient boiler). These retrofits are highly beneficial.

#### **Energy production and storage on site**

“High tech” solutions, such as the use of battery systems for stationary energy storage, should be defined in detail due to the relatively high environmental impact of battery manufacturing.

Depending on the specific, local boundary conditions of the shopping centre, the use of combined photovoltaic panel (PV) and battery can – but do not necessary - lead to environmental benefits over the whole lifecycle. For instance, influencing factors are the constitution of electricity grids, the overall energy storage capabilities and the shares of renewable energy sources in the local electricity mix.

Solutions producing electricity on site (e.g. PVs or wind turbines) have overall positive environmental effects. In case of PVs, the environmental payback times – the timespan that PV plants need to operate in order to compensate the production and end-of-life of the photovoltaic module – vary depending on the solar irradiation and the technology (e.g. polycrystalline, monocrystalline, thin film, etc.). In Norway, with a solar radiation of around 650 kWh/m<sup>2</sup>/year, the environmental payback time of PVs in case of primary energy

demand (non-renewable) is around 4 years. In Italy, with an irradiation of 1900 kWh/m<sup>2</sup>/year, the same PV module has an energy payback time of around 1.5 years.

#### **Retrofitting of the building envelope**

Solutions with a relatively high material consumption (e.g. wall insulation) and relatively low energy savings should be carefully considered. The envelope retrofitting makes sense depending on its quality, country and heating and cooling supply. The environmental payback time can be around 5 years or even higher, but further analyses are needed.

### **18.1.2 OPTIMIZATION OF THE PRODUCTION AND END OF LIFE (EOL) PHASE**

Besides the use phase, the environmental impact of the production and EOL phases can also be important. If the optimizations mentioned above have already been undertaken or the energy demand for the use phase is already optimized or based on renewable energy carriers, the materials used for the retrofitting gain importance.

#### **Reduction of the materials used**

Usually the environmental impact of the construction materials and the retrofitting measures are in correlation with the weight of the material. The heavier a non-renewable material is, the bigger is usually the environmental impact (e.g. concrete, bricks, steel, etc.). These heavy non-renewable materials should be avoided if possible, but this is just a rule of thumb. If there are interdependences between material properties and the energy consumption of the building, these effects have to be carefully analysed (e.g. thermal storage capacity of concrete and its effect on the building’s heating and cooling demand). In addition, multifunctional materials offering several functions (e.g. enhanced thermal conductivity, wall ending) with one single material prevent the use of extra products.

### Use of renewable materials

The use of renewable materials can help reducing the environmental impact. Special care has to be given to those that have an effect on the energy demand of the building. For instance, wooden materials help reducing the environmental impact (e.g. global warming potential, GWP) of the lifecycle stages “production” and “end-of-life” but due to the – in contrast to concrete – low thermal conductivity these materials can lead to a higher cooling demand and therefore a higher electricity demand with a higher overall environmental impact. These possible negative effects should be carefully considered.

### Optimization of building materials end-of-life

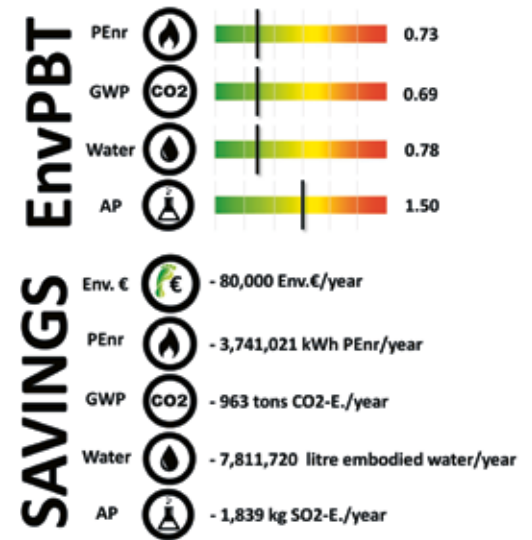
Special care should also be given to the EOL of retrofitting measures, as, usually, construction materials are treated in the end-of-life phases (e.g. recycling, incineration, landfill). Especially in

the case of shopping centres considered historic monuments, reversible and maybe even reusable materials can be of great interest. These materials can be easily deconstructed while not interfering with the building structure, and can be reused afterwards.

If the share of renewable energy carriers is very high, decisions on retrofitting measures should be made case by case and with the support of Life Cycle Assessment experts, because the boundary conditions, model assumptions and systems under evaluation are crucial in these cases.

Summarizing, it's important to consider the environmental effects of the retrofitting measures of shopping centres. Especially when investigating energy-efficient shopping centres, a deeper look at the material side allows avoiding a potential shift of burdens and an overall negative impact.

**Figure 18.3 - Communication of the retrofitting solution-set for the shopping centre Katané.** Source: Fraunhofer IBP.



THIS IS IMPORTANT TO CONSIDER THE ENVIRONMENTAL EFFECTS OF THE RETROFITTING MEASURES OF SHOPPING CENTRES. ESPECIALLY WHEN INVESTIGATING ENERGY-EFFICIENT SHOPPING CENTRES, A DEEPER LOOK AT THE MATERIAL SIDE ALLOWS AVOIDING A POTENTIAL SHIFT OF BURDENS AND AN OVERALL NEGATIVE IMPACT.

## 18.2 ASSESSMENT OF SOCIO-CULTURAL IMPACT

Besides assessing the environmental and economic impacts of CommONEnergy retrofitting measures, it is important to also consider social aspects to get a full overview on sustainability.

First, social and functional indicators developed by the EU FP7 Open House<sup>114</sup> project for the sustainability assessment of buildings are introduced. Next, the use phases of CommONEnergy solution-sets are assessed qualitatively using the Open House indicators as a basis. Some of them not applicable in the CommONEnergy framework are excluded from further considerations.

This first assessment shows that most retrofitting measures are positively influencing thermal comfort. Retrofitting measures related to lighting also positively influence visual comfort and personal safety and security of users; measures dealing with ventilation have an additional impact on indoor air quality. Most retrofitting measures influence more than one indicator. Those positively influencing most indicators and therefore rating best are modular multifunctional climate adaptive façade systems, green integration, thermo-acoustic envelopes and intelligent Building Energy Management System (iBEMS) and control strategies.

In addition to socio-functional aspects of retrofitting that relate to the shopping centre user, a variety of social implications are linked to the value chain of the products used for the retrofitting measures and energy consumption in the use phase. Most of them are directly related to the workers participating in the value chain, regarding for example wages, labour laws or health and safety. Others rather perceive workers as inhabitants of countries or regions characterized

by their behaviour towards human rights. Assessing a lifecycle with regards to such social issues is not yet a state-of-the art procedure widely used but rather an innovative way to bring transparency to value chains and to identify social shifts of burden. To what extent do we rely or depend on instable countries? Do we benefit of other people's misery? How can we improve the social performance of our products? And, regarding the retrofitting of shopping centres, in which way do they improve the social characteristics of their lifecycles?

One possible method to assess the social aspect is the Life Cycle Working Environment (LCWE)<sup>115-116</sup> which uses environmental Life Cycle Assessment models as a basis from which the added value is calculated for every process along the value chain. Relating processes to different industry branches, locating them on a country level, the method enables to characterize process working seconds along the value chain regarding different social indicators. CommONEnergy uses social indicators as provided by the Social Hotspots Database (SoHo)<sup>117</sup> which classifies working time at different risk levels for each indicator. Results then show the characteristic risk distribution of the value chain, either displayed by single indicators, or condensed into one.

When presenting the results, the LCWE-SoHo risk distributions for the reference cases are first shown, giving insights into the social risk profile of the energy consumption in the different case study countries. For example, a country like Austria that uses high shares of renewables in its power grid mix receives good results for Health and Safety in comparison with countries that purchase a great part of their energy resources globally. Most case-study country grid mixes show low risks for human rights violations or risks related to bad governance.

Both methods, LCWE-SoHo and the adapted Open House indicators, are combined in the CommONEnergy socio-functional and cultural assessment. The combined method is used for every shopping centre and for each rehabilitation measure. For this method, an index displaying LCWE-SoHo results was developed, which includes both the mean risk variation and the reduction of high-risk work for the indicator categories Labour Laws and Decent Work, Human Health, Human Rights and Governance.



**ONE POSSIBLE METHOD TO ASSESS THE SOCIAL ASPECT IS THE LIFE CYCLE WORKING ENVIRONMENT (LCWE)<sup>115-116</sup> WHICH USES ENVIRONMENTAL LIFE CYCLE ASSESSMENT MODELS AS A BASIS FROM WHICH THE ADDED VALUE IS CALCULATED FOR EVERY PROCESS ALONG THE VALUE CHAIN.**

<sup>114</sup> <http://www.openhouse-fp7.eu/>

<sup>115</sup> Bos, U., Beck T. (2011). The Life Cycle Working Environment Method (LCWE) - integration of social aspects in Life Cycle Assessment.

<sup>116</sup> Barthel, L. (2015). Methode zur Abschätzung sozialer Aspekte in Lebenszyklusuntersuchungen auf Basis statistischer Daten / Leif-Patrik Barthel - Stuttgart: Fraunhofer-Verl. - 129 S., graph. Darst.(Forschungsergebnisse aus der Bauphysik; 21) Zugl.: Stuttgart, Univ., Diss., 2014 Hauptberichter: Sedlbauer, Klaus ISBN 978-3-8396-0849-4 and ISBN 3-8396-0849-X.

<sup>117</sup> <https://socialhotspot.org/>

Results show that the reduction of a shopping centre's energy demand leads to an overall reduction of high-risk work. Slight shifts in risk distribution are caused by global or EU-produced processes - to which are assigned global or EU risk averages - and lead to higher mean risk values than those directly assigned to highly industrialised countries. Furthermore, where the upstream chain information of the products applied in the retrofitting measures is of sufficient relevance and spatial information is available, a shift towards higher mean risk values can be identified. This happens because the negative working conditions in terms of the assessed categories show higher risks in the resource originating and primary product producing countries.

The highest indicator value is reached in the indicator Health and Safety in the case study City Syd for retrofitting measure 4.3, including the preceding measures. Negative impacts occurred especially concerning the Open House indicators Conversion Feasibility and Area Efficiency, which can be reduced by measures promoting energy efficiency.

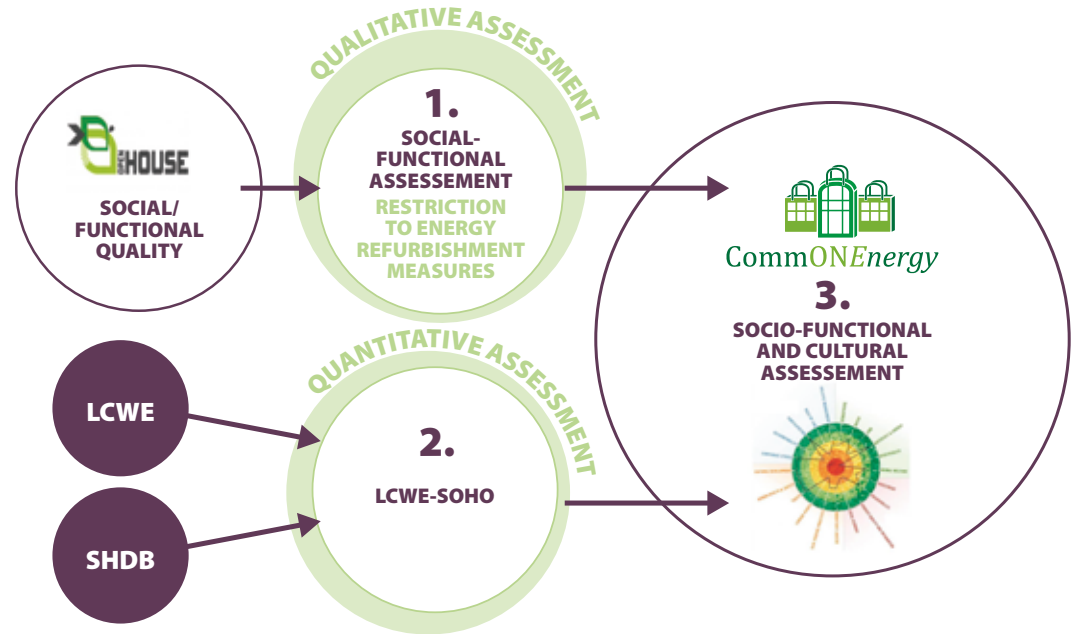
To summarize the results of all the indicators into one diagram, all the values for the last retrofitting measure of each case study are added without weighting. Also, the results are depicted in a slider diagram showing how the case study performs compared to the best possible assessment (full score for all indicators). Best overall ratings in the socio-functional and cultural assessment are identified for City Syd and Modena Canaletto.

**Figure 18.6 - Summarizing slider diagram for case study Katané.** Source: Fraunhofer IBP.

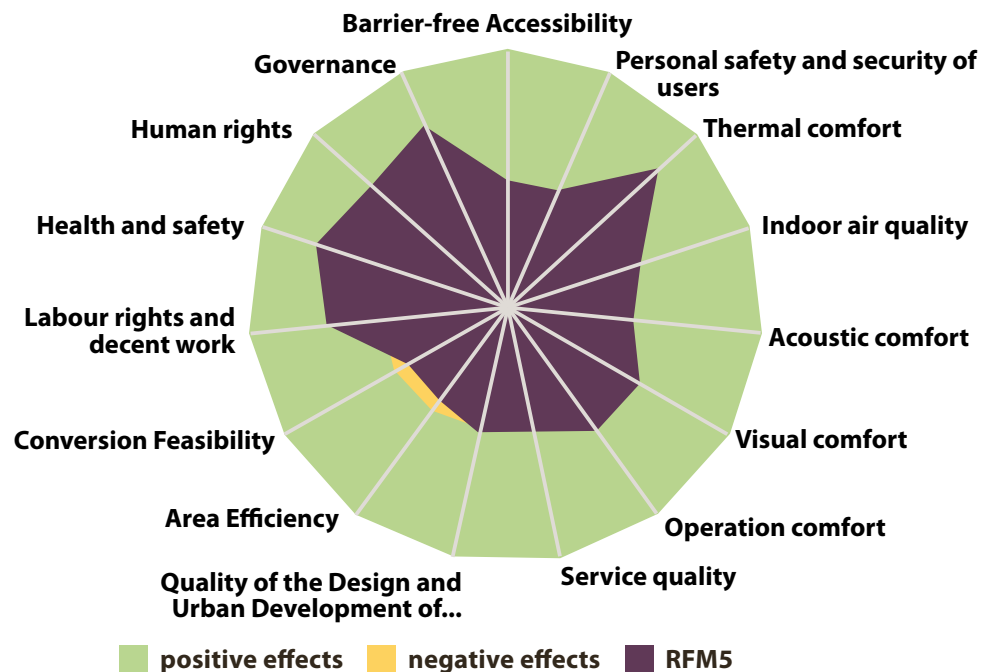


**Figure 18.4 – Elements of the CommONEnergy socio-functional and cultural assessment.**

Source: Fraunhofer IBP.



**Figure 18.5 - Socio-functional and cultural assessment of one among the hypothesized retrofitting measures (in particular: RFM5) for case study Katané.** Source: Fraunhofer IBP.



Possible indicators are:

- Indicator Wages: It is a well-known premise that much of the world's working population does not earn sufficiently to support themselves and a family with food, shelter and health care. The indicator assesses the risk of sector average wages being lower than a country's non-poverty guideline.
- Indicator Child Labour: Child labour refers to work for children under the age of 18 that is mentally, physically, socially and/or morally dangerous or harmful and interferes with their schooling. United Nations Children's Fund (UNICEF) defines child labour as work that exceeds a minimum number of hours, depending on the age of a child and on the type of work, for example for ages 12-14:
  - at least 14 hours of economic or 28 hours of domestic work per week. The indicator assesses the risk of child labour in sector.
- Indicators Fatal / Non-Fatal Injuries: According to the International Labour Organization (ILO), the definition of an occupational injury is that resulting from an accident arising out of or in the course of employment, including commuting, that may result in death, personal injury, or disease involving loss of working time. The indicators assess the risk for fatal / non-fatal injuries.
- Indicator Indigenous Rights: The situation of indigenous peoples in many parts of the world continues to be critical. They are often severely disadvantaged, faced by systemic discrimination at all levels of society, excluded from access to natural resources, displaced, entrenched in extreme poverty and more. The indicator assesses the risk that indigenous people are negatively impacted at sector level.
- Indicator Corruption: Corruption can occur in both public and private sector. And it has the ability to cripple not only a country's social health, but its economic health as well. Forms and definitions of corruption vary, but they typically include bribery, extortion, cronyism, bias, patronage and embezzlement. The indicator assesses the overall risk of corruption.

In order to communicate the results for municipalities or visitors of the shopping centre within CommONEnergy, social and socio-functional rating and explanation icons were developed (see Figure 18.6).

## REFERENCES

---

ISO 14040 Environmental management – Life cycle assessment – Principles and framework.

ISO 14044 Environmental management – Life cycle assessment – Requirements and guidelines

EN 15978: Sustainability of construction works – Sustainability assessment of buildings – calculation method. CEN – European Committee for Standardization. Brussels: CEN – CENELEC 2010.

EN 15804: Sustainability of construction works – Environmental product declarations – Core rules for the product category of building products. CEN – European Committee for Standardization. Brussels: CEN – CENELEC 2011.

European Commission – Joint Research Centre – Institute for Environment and Sustainability (Ed.): ILCD Handbook. General guide for life cycle assessment: detailed guidance. First edition. Luxembourg: Publications Office of the European Union 2010. ISBN: 978-92-79-19092-6.

European Commission – Joint Research Centre – Institute for Environment and Sustainability (Ed.): ILCD Handbook. Analysis of existing Environmental Impact Assessment methodologies for use in Life Cycle Assessment. First edition. Luxembourg: Publications Office of the European Union 2010.

European Commission – Joint Research Centre – Institute for Environment and Sustainability (Ed.): ILCD Handbook. Framework and requirements for Life Cycle Impact Assessment models and indicators. First edition. Luxembourg: Publications Office of the European Union 2010.

European Commission – Joint Research Centre – Institute for Environment and Sustainability (Ed.): ILCD Handbook. Recommendations for Life Cycle Impact Assessment in the European context – based on existing environmental impact assessment models and factors. First edition. Luxembourg: Publications Office of the European Union 2011. ISBN: 978-92-79-17451-3.

European Commission – Joint Research Centre – Institute for Environment and Sustainability (Ed.): ILCD Handbook. Characterization Factors of the ILCD, Recommended Life Cycle Impact Assessment methods, database and supporting information. First edition. Luxembourg: Publications Office of the European Union 2012. ISBN: 978-92-79-22727-1.



# 19.

## DEVELOPMENT OF RETROFITTING SOLUTION-SETS

The solution-set is a combination of energy conservation (passive solutions, heat recovery systems, and strategies for exploiting local climatic conditions) and energy efficiency measures (active solutions and control ones). The measures are integrated by looking for and exploiting synergies among HVAC, lighting, refrigeration, energy use as well as for building correlated services (parking, renewable energy harvesting and local energy production etc.). The retrofitting solution-sets aim at reducing building energy needs, enhancing the overall energy efficiency to provide appropriate Indoor Environmental Quality (IEQ) and exploiting Renewable Energy Sources (RES).

Energy simulation models of reference buildings allow quantifying the energy saving potential of the developed solution-sets. The building energy simulation models enable us to predict energy consumption and loads on an hourly-basis, as well as indoor conditions and interactions among solutions, and they can be also used for defining management strategies.

The building energy simulation models are validated by:

- Comparing model results with utility bills;
- Interviewing the facility managers;
- Benchmarking against standard percentage of energy use to break down aggregated data;
- Benchmarking against standard daily profiles.

The Integrated Modelling Environment (IME) supports all the shopping centre retrofitting

phases by gathering in the same simulation model (i) building (ii) HVAC, refrigeration systems and components (iii) daylighting/shading/lighting (iv) storage technologies (v) RES technologies (vi) natural ventilation and infiltration (vii) non-conventional envelope solutions (vegetation, multi-functional coating and materials, etc.).

The retrofit strategy of each reference building was defined starting from the identification of inefficiencies and the general needs of the facility management.

Table 19.1 compares the energy conservation and energy efficiency measures considered in the analysed solution-sets.

Table A-1 depicts the best conditions for the application of the technologies developed within the project.



---

THE SOLUTION-SET IS A COMBINATION OF ENERGY CONSERVATION AND ENERGY EFFICIENCY MEASURES.

---



**Table 19.1 - Energy conservation and energy efficiency measures**

	<b>ENERGY EFFICIENCY MEASURES (INDIVIDUAL SOLUTIONS)</b>	<b>DESCRIPTION</b>	<b>EXPECTED IMPACT FOR HVAC CONSUMPTION</b>	<b>EXPECTED IMPACT FOR COMFORT</b>
1	<b>GEOHERMAL HEAT PUMP (GHP)</b>	Installation of a new GHP replacing an old one in the building.	Increase in the performance of the new heat pumps.	Improvement in comfort conditions due to the new distribution systems.
2	<b>EFFICIENT LIGHTING</b>	Installation of a more efficient lighting system (LED) and advanced control management.	Reduction in electricity and cooling consumption. Increase of heating demand.	Visual comfort and perception are more stable and natural. The reduced internal heat gains will reduce surface and air temperatures. In summer this will increase comfort, in winter it will reduce it.
3	<b>RENEWABLE ENERGY SOURCE (RES) INTEGRATION – PHOTOVOLTAIC (PV) PANELS</b>	On-site RES installation to produce electricity increases self-consumption and self-production and thus reduces the amount extracted from the grid. If the PV is combined with a battery energy storage system, it is an advantageous situation for supplying a dedicated load (e.g. lighting system) or shave the peak (only to smooth the energy profile and not strictly related to the energy prices during the day).	Generation of electricity production.	If PV panels are installed in canopies, it will create shaded parking lots, which are preferred especially during the summer period.
4	<b>EFFICIENT APPLIANCES</b>	Exploiting existing systems and replacement of new more efficient appliances, if possible.	Reduction in electricity and cooling consumption. Increase of heating demand.	The reduced internal heat gains will reduce surface and air temperatures. In summer, this will increase comfort, while in winter it will have the opposite effect.
5	<b>NATURAL VENTILATION</b>	Installation of natural ventilation through openable windows and advanced control strategies.	Reduction in cooling and ventilation needs.	Lower ceiling surface temperature improve thermal comfort in summer. Increasing the air velocity within the indoor environment improves the comfort sensation of customers at high indoor temperatures. The use of ventilative cooling could have a positive impact on indoor temperature, especially during mid-season and summer.
6	<b>HEAT RECOVERY SYSTEM</b>	Installation of heat recovery system and advanced control strategies.	Reduction in heating demand.	-
7	<b>REFRIGERATION</b>	Installation of new refrigeration units using Carbon Dioxide (CO <sub>2</sub> ) as refrigeration fluid. Installation of closed cabinets.	Reduction in refrigeration and heating demand.	More uniform temperature distribution between cabinet corridors and the rest of the supermarket.

8	<b>INSULATION</b>	Installation of new insulation in construction walls/floors/roofs.	Reduction in heating and cooling demand.	Softening of comfort condition in both summer and winter periods.
9	<b>REFLECTIVE COATING</b>	Application of reflective coatings (70-90% reflectivity) in external walls.	Small reduction in cooling demand.	Indoor surface roof temperature will be lower or higher depending on the season resulting in a more uniform temperature inside the zone.
10	<b>FREE COOLING</b>	Mechanical free cooling.	Reduction of cooling demand.	Reduction of the peak temperature during day especially during mid-season; lower temperature during the first opening hours.
11	<b>HEAT PUMPS WATER LOOP</b>	A water loop acts as source for several electric reversible heat pumps which provide climate control on the various thermal zones. Heat recovery is performed by collecting heat from the condenser/gas cooler of the refrigeration system in the cold season and transferring it to the heat pumps water loop to maintain a certain temperature.	Reduction of heat pumps and auxiliary heater electricity consumption in the cold season.	-
12	<b>HEATING &amp; COOLING SET POINT MANAGEMENT</b>	To set more relaxed comfort temperature ranges.	Reduction in heating and cooling demand.	Impact on thermal comfort can be monitored by means of measurement and interview campaigns.
13	<b>DEMAND CONTROL VENTILATION</b>	The amount of outdoor ventilation is adjusted depending on the inflow of people and/or the level of CO <sub>2</sub> .	Reduction in ventilation consumption.	Even though the amount of outdoor ventilation might be lower than the baseline solution, no impact on indoor air quality is expected because air changes are delivered just when they are needed.
14	<b>REVOLVING DOORS</b>	Installation of revolving doors at the main entrances.	Reduction in heating demand and infiltration losses.	The impact on thermal comfort is expected especially near the entrances, where the possibilities of cold draughts, especially during the winter season, are consistently limited.
15	<b>SHADINGS</b>	Installation of shadings in south façade glazing.	Reduction of cooling demand.	Improvement of comfort during the occupied hours. Softening discomfort due to overheating especially in summer and mid-season periods.
16	<b>GREEN INTEGRATION</b>	Installation of exterior wall covered with climbing vegetation (foliage fixed with wiring).	Small energy savings during summer conditions by solar shading and thermal energy savings by reduced air infiltration rates because of the vegetation.	Improvement of thermal comfort inside the building and "green" visual impact. Improvement of microclimate in the neighbourhood of shopping centre by humidity and dust particulate matter (PMs). Improved rainfall water management.

Once the solution-set is defined, it can be implemented in the simulation model to assess its energy saving potential.

The energy savings related to each single measure can be barely broken down since the energy used in a shopping centre is dynamic and based on interactions among HVAC equipment and internal/external loads. Complex and often unexpected interactions might occur between systems and various heat transfer and operation modes. Thanks to the Integrated Modelling Environment (IME), we can test and quantify the potential savings determined by energy conservation and efficiency measures.

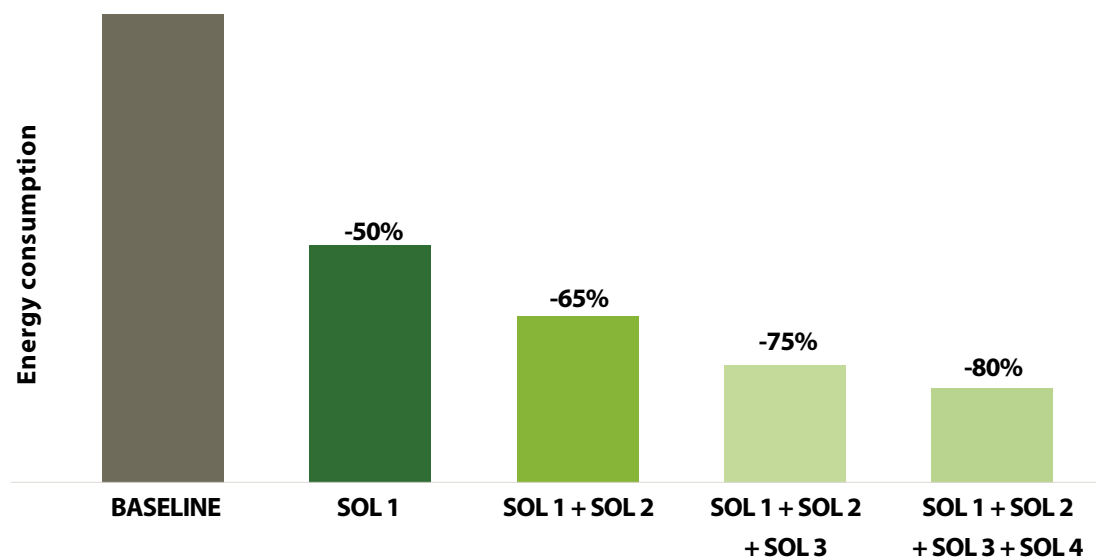
Therefore, we applied the measure stacking analysis method to evaluate the energy saving related to each measure proposed. This analysis method includes changes from previous measures in order to avoid double-counting energy savings. In this framework, the order in which the measures are evaluated plays an important role.

To avoid double-counting energy savings we proceeded by evaluating first energy efficient measures affecting internal loads (i.e. efficient lighting, schedules etc..) and then measures affecting air systems, central heating and cooling plant as well as heat rejection.

Furthermore, the energy efficiency measures are also analysed from an economic point of view by calculating the Return of Investment (ROI), the payback time and the Net Present Value.

It is an iterative process, therefore whenever the energy and/or the economic results are not successful, the solution-set proposed is reviewed until it reaches satisfying energy and cost savings.

**Figure 19.1 - Energy efficient measures stacking method.** Source: EURAC.



**IT IS AN ITERATIVE PROCESS, THEREFORE WHENEVER THE ENERGY AND/OR THE ECONOMIC RESULTS ARE NOT SUCCESSFUL, THE SOLUTION-SET PROPOSED IS REVIEWED UNTIL IT REACHES SATISFYING ENERGY AND COST SAVINGS.**

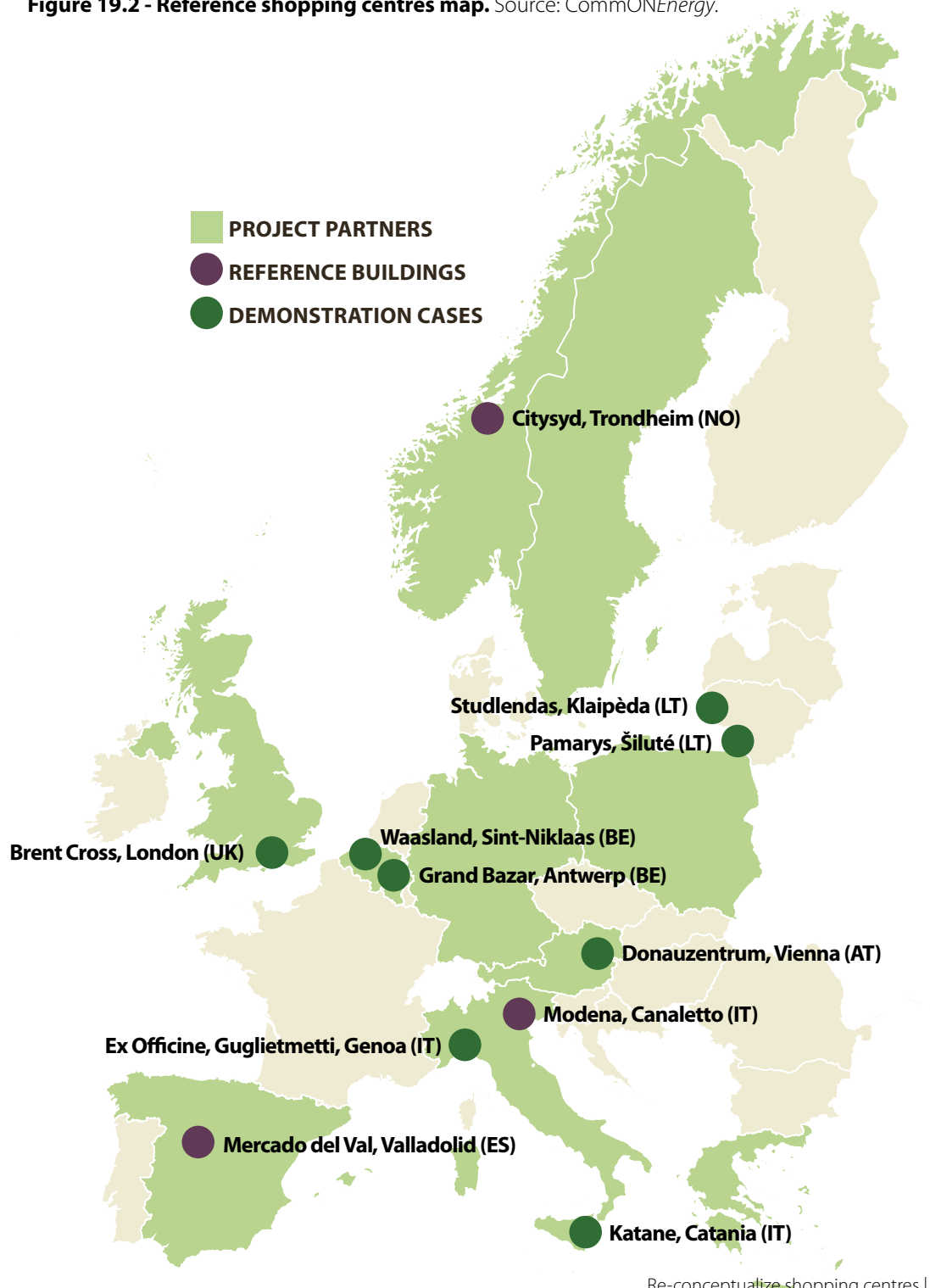
## 19.1 CASE STUDIES: LESSON LEARNT AND STANDARD REPORTING

The reference buildings studied are listed in Table 19.2 (the first three buildings correspond with the three demo-cases, where specific retrofitting packages were actually implemented).

**Table 19.2 - Demo cases and reference buildings.** Source: CommONEnergy.

BUILDING	MANAGER	LOCATION
Mercado del Val	Municipality of Valladolid	Valladolid (Spain)
City Syd	Storebrand	Trondheim (Norway)
Coop Canaletto	Coop Estense	Modena (Italy)
Coop Valbisagno	Coop Liguria	Geneva (Italy)
Brent Cross	Hammerson	London (UK)
Katané	Ipercoop Sicilia	Catania (Italy)
Donauzentrum	Unibail Rodamco	Wien (Austria)
Pamarys	Baltisches Haus	Silute (Lithuania)
Studlendas	Baltisches Haus	Klaipeda (Lithuania)
Waasland Shopping centre	Devimo	Sint-Niklaas (Belgium)
Grand Bazar	Devimo	Antwerp (Belgium)

**Figure 19.2 - Reference shopping centres map.** Source: CommONEnergy.

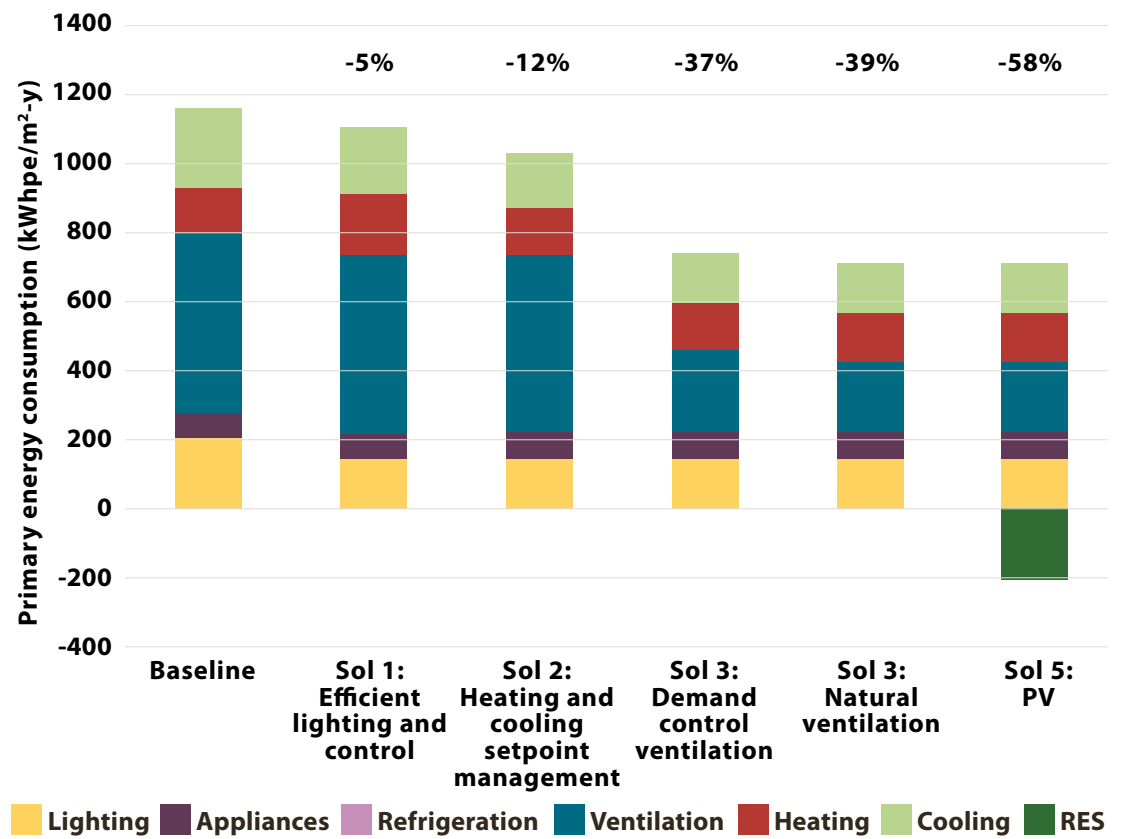


The solution-sets have been evaluated by means of comfort, energy, environmental and economic indicators.

The graph in Figure 19.3 shows the outcomes in terms of primary energy consumption by progressively stacking energy retrofit measures. The graphs in Figure 19.4 and Figure 19.5 showcase example of the economic analysis outcomes. The cash inflows are due to the operating costs savings following the implementation of the retrofit solution-sets.

In Table 19.3, solution-sets are identified. Analysing all the solution-sets, it can be noticed that not all of them reach the 75% of primary energy reduction. Within the task group (extended to reference buildings representative people) the initial investment as well as the return of investment, are considered more important than high energy savings. The economic impact of the retrofit and the improvement of customers' experience related to indoor environmental quality seem to be "more important" for owners, energy managers, and retail developers. In general, the solution-sets fulfil the 7-year payback, with a meaningful reduction of primary energy consumption and increasing rate of renewable sources.

**Figure 19.3 - Primary energy savings.** Source: EURAC.



**Figure 19.4 - Cash inflows and outflows.** Source: EURAC.

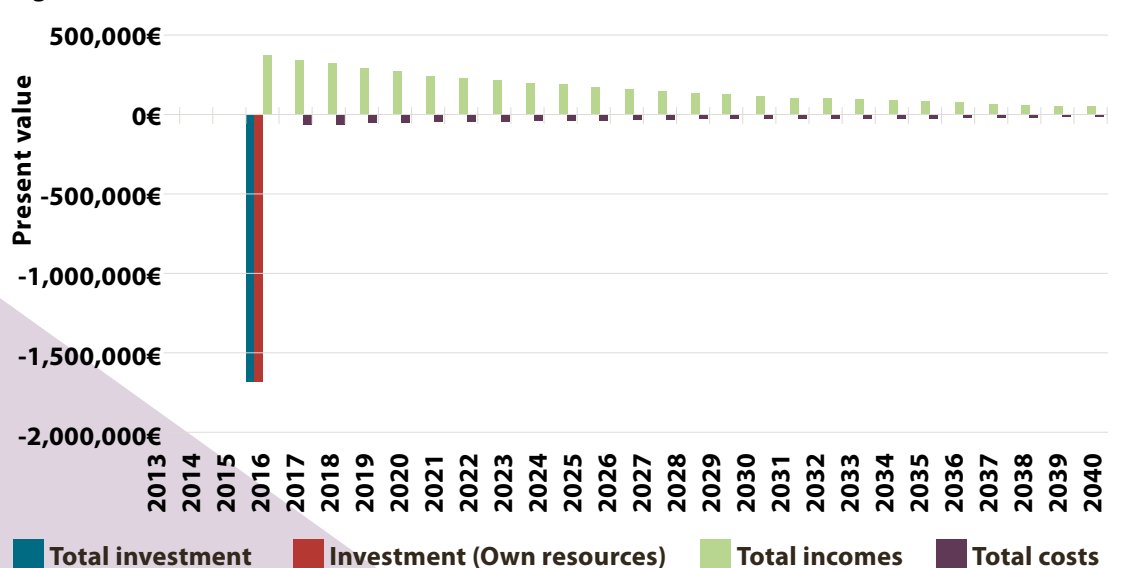
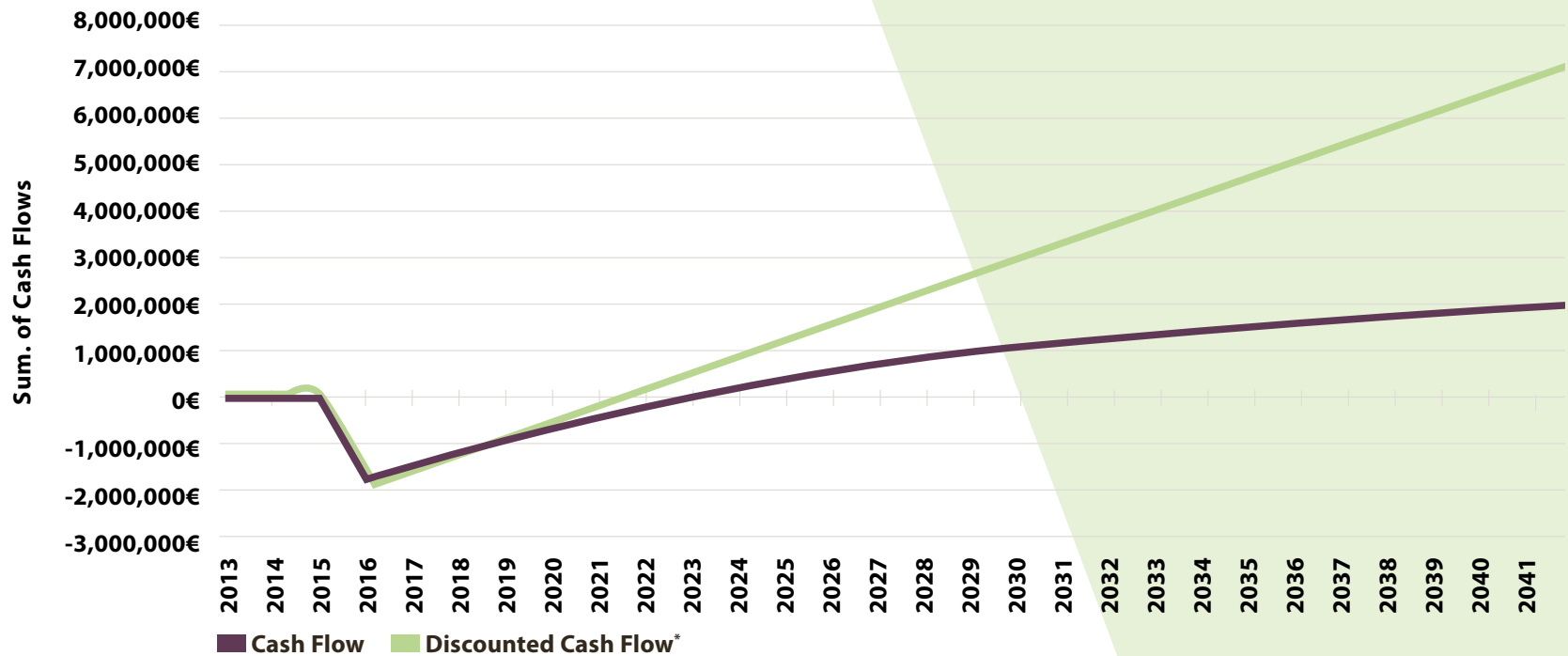


Figure 19.5- Cash flow diagram. Source: EURAC.



(\*)Cash flow that takes into account the time-value of the money

Also, considering the feedback collected during the stakeholder workshops, the identified solution-sets have a high replication potential, and the structured methodological framework enables to adjust them to different contexts, presenting, through standardised key performance indicators, energy, indoor environmental quality and economic achievable results. This way, investors, facility managers and designers can start a process for planning a shopping centre retrofit with consistent figures of possible technology solutions and overall achievable performance targets. Then, the first retrofitting concept must be detailed with dedicated modelling and simulation activity, by using tools as the ones developed within the CommONEnergy project.



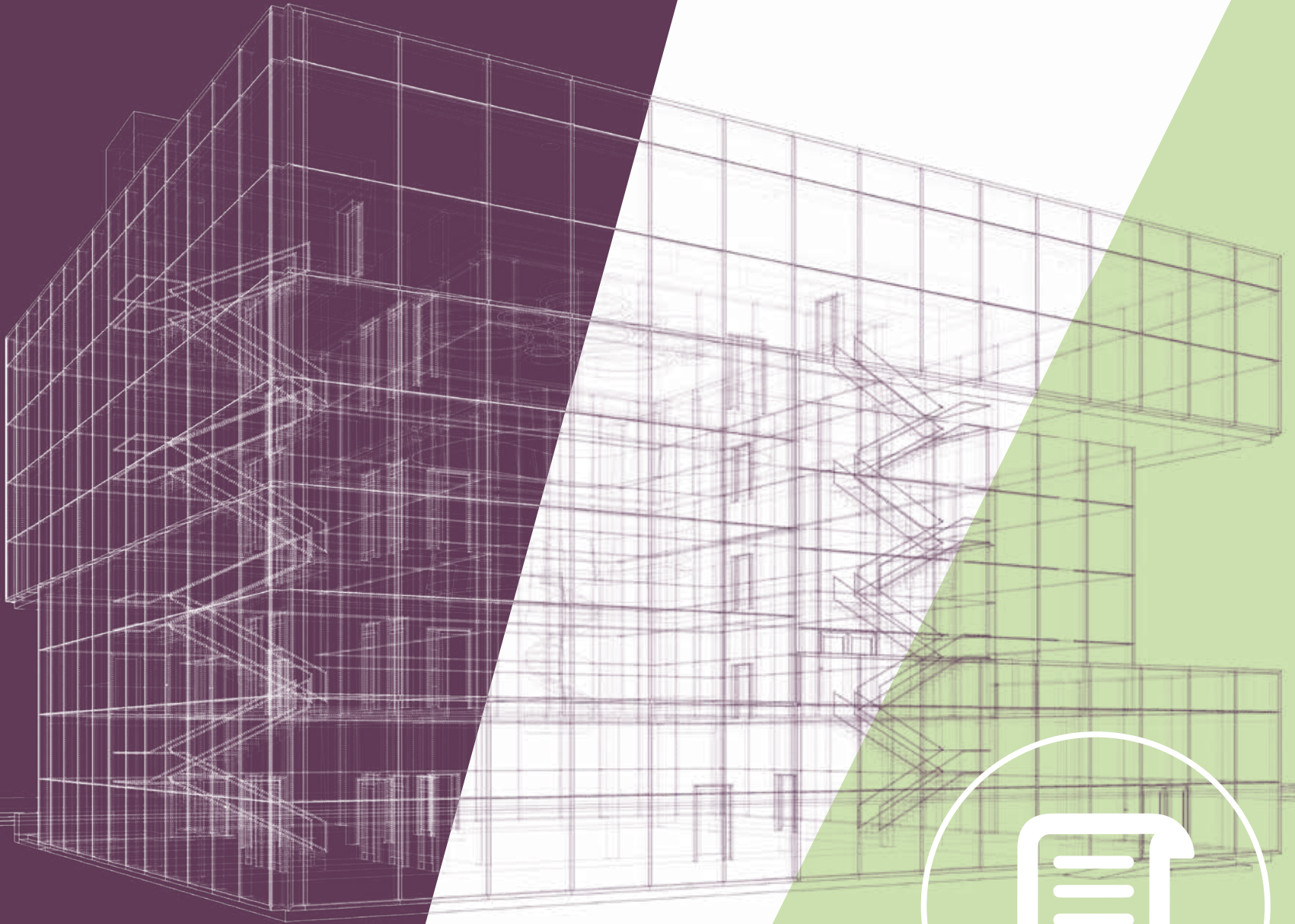
THE SOLUTION-SETS HAVE BEEN EVALUATED BY MEANS OF COMFORT, ENERGY, ENVIRONMENTAL AND ECONOMIC INDICATORS.

**Table 19.3 - Identified solution-sets.**

	<b>SOLUTION - SET</b>	<b>REFERENCE BUILDING</b>	<b>EXPECTED SAVINGS/ PAYBACK</b>	<b>REPLICATION POTENTIAL</b>
1	<ul style="list-style-type: none"> <li>• <b>Geothermal heat pump</b></li> <li>• <b>Modular climate adaptive multifunctional façade</b></li> <li>• <b>Effective artificial lighting equipment + control strategies</b></li> </ul>	Mercado del Val (Valladolid – Spain)	70% PE / 6.8 years	Energy efficient measure implemented and the façade system could be applied to other shopping centres with large glazed façades.
2	<ul style="list-style-type: none"> <li>• <b>Efficient lighting system and controls</b></li> <li>• <b>Efficient appliances</b></li> <li>• <b>Natural ventilation</b></li> <li>• <b>Insulation</b></li> </ul>	City Syd (Trondheim – Norway)	61-66% PE / <7 years	There is a high replication potential for this solution-set for shopping centres with intensive heating demands and with openable windows.
3	<ul style="list-style-type: none"> <li>• <b>Efficient lighting system and controls</b></li> <li>• <b>Efficient appliances</b></li> <li>• <b>Natural ventilation</b></li> <li>• <b>Insulation</b></li> <li>• <b>Photovoltaic plant</b></li> </ul>	City Syd (Trondheim – Norway)	75% PE / 12-13 years	This solution-set should be analysed more deeply in order to study if the economic analysis satisfies the requirements of the investment from the owner. On the other hand, since a PV system is taken into account, the location of the shopping centre should show good perspectives for this installation (enough renewable resource and/or good economic conditions from grants or subsidies).
4	<ul style="list-style-type: none"> <li>• <b>Efficient lighting system and controls</b></li> <li>• <b>Replacement of refrigeration cabinets</b></li> <li>• <b>Building envelope thermal improvement</b></li> <li>• <b>Reflective coating</b></li> <li>• <b>Improving HVAC efficiency</b></li> <li>• <b>Coupling HVAC and refrigeration</b></li> </ul>	Coop Canaletto (Modena – Italy)	55% PE / 7.3-11 years	The solution-set is focused on HVAC and refrigeration plant integration. Because of the small size of the supermarket, recovered waste heat can significantly contribute to reduce the supermarket energy use for heating if combined with other energy-conservation measures (i.e. closed refrigeration cabinets, envelope insulation). This solution-set can potentially be replicated in small size supermarkets where energy consumption is mainly due to refrigeration.
5	<ul style="list-style-type: none"> <li>• <b>Efficient lighting system and controls</b></li> <li>• <b>Refrigeration – CO<sub>2</sub></b></li> <li>• <b>Heat pumps water loop</b></li> <li>• <b>Natural ventilation</b></li> <li>• <b>PV plant</b></li> </ul>	Coop Valbisagno (Genoa – Italy)	40% PE / 7.2 – 11.1 years	This solution-set proposed a heat pump water loop and it is suitable for major retrofits of shopping centres which need HVAC system replacement. The measure selected for the refrigeration systems could be also generalised for systems based on a cascade system with CO <sub>2</sub> as refrigerant for the direct expansion of LT (Low Temperature) equipment, and R134a as refrigerant for the MT (Medium Temperature) portion of the system; however, the advantage of this technology mainly relates to environmental aspects rather than energy savings.
6	<ul style="list-style-type: none"> <li>• <b>Efficient lighting system and controls</b></li> <li>• <b>Appliances replacement</b></li> <li>• <b>PV system</b></li> </ul>	Brent Cross (-UK)	55% PE / 7 years or 75% PE / 19.4 years	The replicability of this solution-set would be high for those locations where the installation of a PV system is cost-effective, because the ambient conditions are favourable or the installation of a renewable system could receive subsidies from the government.

7	<ul style="list-style-type: none"> <li>• <b>Efficient lighting system and controls</b></li> <li>• <b>Heating and cooling set point management</b></li> <li>• <b>Demand control ventilation (DCV)</b></li> <li>• <b>Natural ventilation</b></li> <li>• <b>PV plant on gallery roof and parking canopies</b></li> </ul>	Katané shopping centre (Katania – Italy)	58% PE / 5.1–6.8 years	This solution-set has a high retrofitting potential since it is mainly focused on the management of existing installations. Apart from the PV system, the energy-efficient measures applied require a low investment, therefore, from an economic point of view it is really convenient when the shopping centre management has a low budget for retrofit purposes.
8	<ul style="list-style-type: none"> <li>• <b>Efficient lighting system and controls</b></li> <li>• <b>Efficient appliances</b></li> <li>• <b>Cooling set point control</b></li> <li>• <b>Natural Ventilation</b></li> <li>• <b>Photovoltaic plant</b></li> <li>• <b>Revolving doors</b></li> </ul>	Donauzentrum (Vienna – Austria)	26% PE / 3.2-3.8 years	Although it has a high replication potential, this solution-set does not offer improvements in terms of lowering energy consumption for buildings with existing good practices in energy sustainability. Although, it is possible to reduce by 25% the primary energy consumption thanks to an investment with a very short payback-time.
9	<ul style="list-style-type: none"> <li>• <b>Effective artificial lighting equipment + control strategies</b></li> <li>• <b>Building envelope thermal improvement</b></li> <li>• <b>Heat recovery and heating set point management</b></li> <li>• <b>RES integration (PV panels + Wind turbine)</b></li> </ul>	Pamarys (Lithuania)	63% PE / 6.3 years	The measures proposed are easily replicable in other shopping centres in areas with a high-heating demand. The replication potential is, therefore, limited to the reduction of heating needs (apart from the PV system). This solution-set would only be interesting for locations with favourable conditions for a PV installation.
10	<ul style="list-style-type: none"> <li>• <b>Effective artificial lighting equipment + control strategies</b></li> </ul>	Studlendas (Lithuania)	50% PE / 5.7 years	The measures proposed are easily replicable in other shopping centres in areas with a high-heating demand. The replication potential is, therefore, limited to improvements in heating needs (apart from the shading for the south façade, which is an energy measure for reducing cooling needs).
11	<ul style="list-style-type: none"> <li>• <b>Building envelope thermal improvement</b></li> <li>• <b>Heat recovery and heating set point management</b></li> <li>• <b>Façade shadings for solar control</b></li> </ul>	Waesland (Sint-Niklaas – Belgium)	60% PE / 6 years	All the individual measures have a high replication potential in shopping centres for both heating and cooling needs.
12	<ul style="list-style-type: none"> <li>• <b>RES integration (PV panels + Wind turbine)</b></li> </ul>	Waesland (Sint-Niklaas – Belgium)	60% PE / 6 years	This solution-set is focused mainly on cooling dominated shopping centres. The integration of batteries means an increase of the investment which in many scenarios makes the installation not viable from an economic point of view. Nowadays, the price of batteries is decreasing, nevertheless it is necessary to study different scenarios because, depending on the country regulation, their installation could be economically feasible or not.
13	<ul style="list-style-type: none"> <li>• <b>Efficient lighting and control</b></li> <li>• <b>Appliances replacement</b></li> <li>• <b>Cooling set point management</b></li> <li>• <b>Heat recovery system</b></li> <li>• <b>Photovoltaic plant</b></li> </ul>	Grand Bazar (Antwerp – Belgium)	40% PE / 5 years	All the individual measures have a high replication potential in shopping centres in heating and cooling dominated climates.
14	<ul style="list-style-type: none"> <li>• <b>Efficient lighting and control</b></li> <li>• <b>Appliances replacement</b></li> <li>• <b>Cooling set point management</b></li> <li>• <b>Heat recovery system</b></li> </ul>	Grand Bazar (Antwerp – Belgium)	36% PE / 4.9 years	The solution-set proposed would be replicable for those buildings without external surfaces for RES integration.



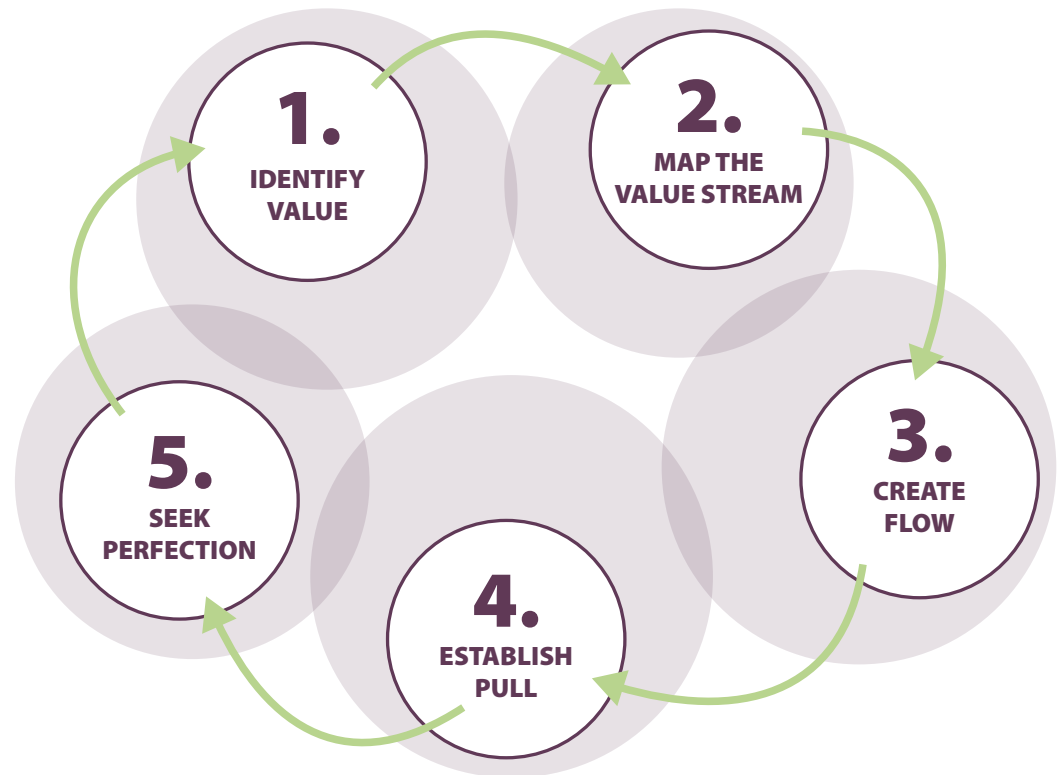


# 20.

## CONCLUSIONS

Shopping centres are a very peculiar kind of buildings due to the specific final energy uses (mainly related to lighting, ventilation, cooling and refrigeration in presence of food supermarkets) and the complexity of the overall system. The need to ensure a certain sales volume, and the state of constant transformation (addressed by marketing reasons) drive the energy retrofiting actions.

Principles of lean thinking can be very helpful for managing retrofiting actions in a shopping centre, identifying the customer satisfaction and experience as the goal pulling the constant change, and seeking for improvement (towards perfection).



(source: <https://www.lean.org/WhatsLean/Principles.cfm>)



INDEED, THE FACILITY MANAGEMENT IS OFTEN CHALLENGING, REQUIRING A CONTINUOUS ADJUSTMENT/IMPROVEMENT PROCESS, COUPLING A COMPLEX OPERATIONAL ORGANIZATION OF VERY DIFFERENT WORKING AND SELLING AREAS WITH THE ENHANCEMENT OF ENERGY EFFICIENCY AND INDOOR ENVIRONMENTAL QUALITY, MARKETING DEMAND TO IMPROVE THE CUSTOMERS' EXPERIENCE AND THE REDUCTION OF ENVIRONMENTAL AND SOCIAL IMPACT BOTH IN CASE OF A SIMPLE SUPERMARKET AND A BIG CENTRE.

The need to reduce non-renewable energy use in shopping centres is itself a driver for retrofitting, bringing to a reduction of operational and overhead costs. However, investment costs associated with retrofitting could be a barrier that needs to be carefully evaluated in terms of Return Of Investment (ROI) and Net Present Value (NPV). Such economic indicators enable to measure the profitability of the investment, but should not be evaluated in absolute terms, rather considering the extra costs related to energy efficiency on top of the budget allocated for the mentioned constant retrofitting. Also, technology solution-sets must be easily integrated in the retrofitting process from the technical and organizational point of view, as they can create value as well.

The need to have easier but still reliable and accurate monitoring and control systems is a driver, especially considering the higher energy flexibility that could lead to important economic benefits, by exploiting the energy storage systems and the interactions with urban infrastructures.

The lack of knowledge at all stakeholder levels is a barrier to energy use reductions. The increase of awareness of owners, managers, tenants, customers and the whole community could be a driver for implementing actions to enhance energy efficiency at urban level, and indoor environmental quality.

The current trends in the shopping centre industry is on one hand to reduce the size and move back towards the city centre and, on the other hand, to add new functions (and associated complexity) for leisure and pleasure. Finally, there is an even bigger attention to green retail, able to attract both tenants and customers because of the higher sensibility towards sustainability.

The described complexity needs effective and viable energy efficient measures and support tools to ensure the optimal definition of the retrofitting concept, its design, implementation and continuous tuning during the operational phase.

Smart tools for managing energy systems, continuous commissioning, training on technologies and methodological approaches, specifically targeting owners, managers, tenants, and customers, increase the overall awareness on the building behaviour, its inefficiencies and potential improvements, making the communication among the stakeholders involved in the retrofitting process easier, while enhancing their ability to contribute to energy savings.

Future developments in the field of shopping centres retrofitting require considering energy efficiency and architectural qualities at the same time. Buildings should be adaptable and spaces flexible both in terms of usage and energy uses. Functionality and technology, however, should not be allowed to dominate at the cost of aesthetic and architectural quality. One of the *CommONEnergy* project survey suggests that the sustainable shopping centres of the future will have high architectural quality while focusing on legibility, durability and energy use. Considering a shopping centre as an energy system the focus will be even more on integration, from both technology and control strategy points of view, and including the exploitation of local climate conditions, and synergies with the urban contexts and energy grids.

*CommONEnergy* highlights the important role shopping centres could have to reach the European sustainability goals, if properly included in the EU Directives. Shopping centres are the only building sector with a retrofitting rate higher than EU 3% target (about 4.4% per year). Therefore, more than 60% of the shopping centre building stock will be upgraded by 2030, representing a unique trigger point to realise sustainable energy-savings solutions along the planned aesthetic retrofittings.

Besides technologies and methodologies, the project developed policy recommendations grouped under four main themes:

- Engaging stakeholders,
- Communicating the benefits of retrofitting,
- Promoting energy efficient technology packages, and
- Supporting the energy transition.

Building on the project's demo cases, and giving concrete examples of the benefits coming from the retrofitting of shopping centres, the recommendations presented in the policy paper<sup>118</sup> can serve as an important basis for the tabling of amendments to Bendtsen's draft, catching the opportunity of a more ambitious revision of the EPBD and a better recognition of the strong role shopping centres can play in achieving the EU energy efficiency targets.

<sup>118</sup> <http://www.commonenergyproject.eu/news/articles/68>



---

FUTURE DEVELOPMENTS IN THE FIELD OF SHOPPING CENTRES RETROFITTING REQUIRE CONSIDERING ENERGY EFFICIENCY AND ARCHITECTURAL QUALITIES AT THE SAME TIME. BUILDINGS SHOULD BE ADAPTABLE AND SPACES FLEXIBLE BOTH IN TERMS OF USAGE AND ENERGY USES. FUNCTIONALITY AND TECHNOLOGY, HOWEVER, SHOULD NOT BE ALLOWED TO DOMINATE AT THE COST OF AESTHETIC AND ARCHITECTURAL QUALITY.

---



# 21.

## ADDITIONAL SOURCES OF INFORMATION ON THE TOPIC

### MEDIA, PLATFORMS AND PROJECTS – EU AND GLOBAL

- Across Magazine
- Architects Council of Europe – ACE CAE
- BREEAM: report „Delivering Sustainable Buildings: Value of BREEAM to Retail in the UK“
- Build UP – information database
- The Consumer Goods Forum
- Construction 21 – information database
- Energy efficient buildings association – E2BA
- Eurobuild CEE - magazine
- Europa Property – news and events
- European Construction Technology Platform – ECTP
- European Consumer Organisation - BEUC
- European Council for Construction Research, Development and Innovation – ECCREDI
- European Network of Construction Companies for Research and Development - ENCORD
- European Public Real Estate Association – EPRA
- European Real Estate Forum – EREF
- European shopping centre trust
- Europe Real Estate – Media, news, publishing
- Images Retailme - News
- International Council of Shopping Centres (ICSC, global) and the ICSC Scorecard
- Landlord Tenant Partnership (US)
- National Retail Federation
- Planet Retail
- Property EU info
- Regio Data Shopping Center Explorer – database
- Retail Forum for sustainability
- Retail Industry Leaders Association – RILA and report „Sustainability becoming core part of retail industry identity“
- Retail Property Analyst
- Retail SEE – Network, news, research
- Retail Update - Magazine
- Retail Week - News
- Shopping centres Index – European directory
- Shopping Mall Expert – magazine
- Tactics – Global online news source for shopping centres
- World Retail Awards

### MEDIA, PLATFORMS AND PROJECTS – COUNTRY LEVEL

#### BELGIUM AND FRANCE

- Bativox (Belgium)
- Batiweb (France)
- EuroCommerce – resource centre (Belgium)
- Tendances (Belgium)

#### GERMANY

- Focus
- German Retail Blog

#### ITALY

- Largo Consumo
- Retail food
- Il quotidiano immobiliare
- Casa e Clima
- Monitor Immobiliare

#### ROMANIA

- Bursa Constructiilor

#### SWITZERLAND

- Baublatt
- Immbolien Business - news

#### UK

- Modern Builder - Magazine
- Shopping centre UK – magazine

In addition, most countries have national councils of shopping centres: <https://www.icsc.org/affiliates-directory>

# ABBREVIATIONS

<b>3D</b>	Three-dimensional space
<b>A/C</b>	Air Conditioning
<b>AHU</b>	Air Handling Unit
<b>BEMS</b>	Building Energy Management System
<b>BESS</b>	Battery Energy Storage System
<b>BEV</b>	Battery Electric Vehicles
<b>BIPV</b>	Building-Integrated Photovoltaic
<b>BMS</b>	Building Management System
<b>BREEAM</b>	Building Research Establishment Environmental Assessment Method
<b>CC</b>	Continuous Commissioning
<b>CFD</b>	Computational Fluid Dynamics
<b>CFL</b>	Compact Fluorescent Light
<b>CHP</b>	Combined Heat and Power
<b>CLO</b>	Constant Light Output
<b>CMA</b>	Common Area, entrances
<b>COP</b>	Coefficient Of Performance
<b>CO<sub>2</sub></b>	Carbon dioxide
<b>CRI</b>	Colour Rendering Index
<b>CRU</b>	Commercial Refrigeration Unit
<b>€/m<sup>2</sup>, €/kWh, €/kWyear</b>	Euro per square meter, euro per kilowatthour, kilowattyear
<b>DALI</b>	Digital Adressable Lighting Interface
<b>DAS</b>	Data Acquisition System
<b>DHW</b>	Domestic Hot Water
<b>DR</b>	Draught Rate
<b>D/R</b>	Demand/Response
<b>EBC</b>	Energy in Buildings and Communities Programme
<b>ECM</b>	Energy Conservation Measures
<b>EOL</b>	End-of-Life
<b>ESS</b>	Energy Storage System
<b>EU</b>	European Union
<b>EV</b>	Electric Vehicle
<b>EV-link</b>	Electric Vehicle link
<b>FCEV</b>	Fuel Cell Electric Vehicles

<b>FDP</b>	Food Department, refrigeration rooms, food processing area
<b>FDS</b>	Food store (vending area only)
<b>GBC</b>	Green Building Council
<b>GDP</b>	Gross domestic product
<b>GHG</b>	Green House Gas
<b>GLA</b>	Gross Leasable Area
<b>GRL</b>	General Retail Lighting
<b>GWP</b>	Global Warming Potential
<b>HDD</b>	Heating Degree Days
<b>HFCs</b>	Hydro-Chlorofluorocarbons
<b>HP</b>	Heat Pumps
<b>HVAC</b>	Heating Ventilation Air Conditioning
<b>iBEMS</b>	intelligent Building Energy Management System
<b>IDP</b>	Integrated Design Process
<b>IEA</b>	International Energy Agency
<b>IEQ</b>	Indoor Environmental Quality
<b>ILO</b>	International Labour Organization
<b>IME</b>	Integrative Modelling Environment
<b>IPMVP</b>	International Performance Measurements and Verification Protocol
<b>IR</b>	Infrared
<b>KPIs</b>	Key Performance Indicators
<b>kWh/m<sup>2</sup>/year</b>	Kilo Watt hours per square meters per year
<b>LCWE-SoHo</b>	Life Cycle Working Environment Social Hotspots Database
<b>LCWE</b>	Life Cycle Working Environment
<b>LED</b>	Light Emitting Diode
<b>LT</b>	Low Temperature
<b>m<sup>2</sup> or sqm</b>	Square meter
<b>MDS</b>	Medium Store, big size stores, anchor stores
<b>M-pack</b>	Test package as for EN23953
<b>MT</b>	Medium Temperature
<b>MW</b>	MegaWatt

<b>NE</b>	North-East
<b>NiMH</b>	nickel methal-hydrid
<b>NT</b>	Normal Temperature
<b>NW</b>	North-West
<b>OFF</b>	Office
<b>PD</b>	Percentage of Dissatisfied
<b>PHEV</b>	Plug-in hybrid electric vehicles
<b>PMV</b>	Predicted Mean Vote
<b>PPD</b>	Predicted Percentage of Dissatisfied
<b>PRK</b>	Parking
<b>PV</b>	Photovoltaic
<b>PVC</b>	Polyvinyl Chloride
<b>R134</b>	tetrafluoroethane: a new mix of substances, not-ozone depleting, used in food refrigeration system with a low global warming potential
<b>R404a</b>	A colourless, odourless mixture of three hydrofluorocarbon compounds in near-azeotropic proportions
<b>R407C</b>	HFC Refrigerant fluid R407C
<b>R410A</b>	HFC Refrigerant fluid R410A
<b>RES</b>	Renewable Energy Sources
<b>ROI</b>	Return of Investment
<b>RST</b>	Restaurant, cafes, food courts
<b>SE</b>	South-East
<b>SHP</b>	Shops, retail stores
<b>SVC</b>	Service room, toilets, changing rooms
<b>SW</b>	South-West
<b>TCR</b>	Technical Room
<b>TRNSYS</b>	Transient System Simulation Tool
<b>TWh</b>	Tera Watt hours (1 000 000 000 kWh)
<b>UNICEF</b>	United Nations Children's Fund
<b>VOC</b>	Volatile Organic Compound
<b>W/m<sup>2</sup></b>	Watt per square meters
<b>WLB</b>	Water Loop Booster
<b>WLHP</b>	Water Loop Heat Pump
<b>WRH</b>	Warehouse

# ANNEX I.

## Application Guideline of multifunctional coating additive

**General information:** This additive is a high-quality product ready to be integrated in any water-based paint and it is applicable for both interior and exterior, providing excellent homogenization with any commercially-available paint.

**Preparation procedure:** Prior to the application, the product should be stirred (at least 10 min with mechanical stirrer) to ensure that the additive is mixed with the paint until a uniform consistency and to break down excess structure.

**Surface preparation:** The primer surface should be dry and free from all contaminations. Do not apply paint when dust is present. Areas of breakdown, damage should be repaired prior to the application of the product.

**Storage:** Must be stored at a temperature of 4°C-35°C, in tightly sealed containers out of direct sunlight.

### **Method of application:**

The product could be applied according to the guidelines of the paint manufacturer and it is compatible with all possible methods, brush, roller and spray application, as it does not affect the characteristics of the carrier matrix of the commercial paint. The coating should be applied in two layers with a drying time between the layers of at least 24 hours or more according to the guidelines of the paint manufacturer. The application should be scheduled so that coating has 3-4 hours to dry before nightfall and the second coat should be laid at the right angles of the first coat.

**Prevention:** Wash thoroughly after handling. Avoid breathing mists and sprays.

### **Response:**

*If on skin:* Wash with plenty of soap and water. If skin irritation occurs: Get medical advice or attention. Take off contaminated clothing and wash it before reuse.

*If in eyes:* Rinse cautiously with water for several minutes. Remove contact lenses, if present and easy to do. Continue rinsing. If eye irritation persists: Get medical advice or attention.

*If inhaled:* Remove person to fresh air and keep comfortable for breathing. Call a poison center or doctor if you feel unwell.



# ANNEX II. Repository of technologies

Innovative technologies for an advance retrofit developed within the EU FP7 CommONEnergy project are collected in Table A-1.

**Table A-1 - Repository of technologies developed within EU FP7 CommONEnergy project.**

TECHNOLOGY	LIST	BRIEF DESCRIPTION	APPLICATION	EXPECTED ENERGY SAVINGS
<b>Ventilative cooling</b>	Enhanced stack ventilation	Automated openings located in the skylights to enhance stack ventilation	Common areas with skylights and openable parts at lower levels	Cooling needs reduction, energy consumption for ventilation reduction
	Wind catcher	Wind catcher integrated into light tubes to naturally ventilate shops	Shops at the last floor with no parking on the roof	Cooling needs reduction, energy consumption for ventilation reduction
	Single-sided ventilation	Automated openings located in the façade to exploit natural ventilation	Common areas/shops with external façade	Cooling needs reduction, energy consumption for ventilation reduction
	Fan-assisted ventilation	Increased mechanical ventilation rates to reduce cooling needs	Common areas/shops/food stores	Cooling needs reduction
<b>Thermal zoning optimization</b>	Radiant panels	Air conditioning in the refrigeration cabinets zones by means of radiant panels	Supermarkets with closed refrigeration cabinets	Energy needs reduction and improved comfort
	Full air with air-supply diffusers against mist formation	Use of specific air diffusers to prevent mist formation on cabinet doors supported by a control system for the activation of electric resistances	Supermarkets with closed refrigeration cabinets	Demisting energy reduction
<b>Modular multifunctional climate adaptive façade</b>	Configuration 1	Bottom and top openings with integrated PVs in the bottom part and shading system	Shops, supermarket, food court in cold/mild climates with envelope air tightness constraints	Cooling & heating needs reduction, energy consumption for ventilation reduction, PV is providing electricity for automation
	Configuration 2	Ventilator louvres with integrated PVs and shading	Atrium, transitional spaces in warm climates with no air tightness constraints	Cooling & heating needs reduction, energy consumption for ventilation reduction, PV is providing electricity for automation

TECHNOLOGY	LIST	BRIEF DESCRIPTION	APPLICATION	EXPECTED ENERGY SAVINGS
<b>Green integration</b>	Surrounding trees, bush, pavement/lawn proportion	Change microclimate characteristics (temperature, humidity, oxygenation etc) in building's surroundings up to 1000m extends	Building's exterior unbuilt areas like parkings, lawns, ect.	Cooling needs reduction
	Intensive/active vegetated roof	Bigger plants, higher initial and exploitation costs, weight-up to 1300kg/m <sup>2</sup> , soil substratum thickness min. 30cm; microclimate change, building heat balance improvement	Common areas/ common green spaces	Cooling & heating needs reduction
	Extensive/passive vegetated roof	Smaller plants, lower costs, weight-50-300kg/m <sup>2</sup> , climbing plants rooted in ground directly or in pots, microclimate change, rain water management improvement, building heat balance improvement	Horizontal shading systems e.g. parking sheds	Cooling needs reduction
	Direct-vegetated wall	The greening system uses the façade as a growing guide; microclimate change, rain water management improvement, building heat balance improvement	East-, south- and west-oriented exterior façades	Cooling & heating needs reduction
	Indirect-vegetated wall	The greening system and the façade are separated by an air cavity; microclimate change, rain water management improvement, building heat balance improvement	East-, south- and west-oriented exterior façades	Cooling & heating needs reduction
<b>Smart coatings</b>	IR-reflective/ absorbing	All possible combinations from these characteristics may be selected	All substrates of roof or façade that could be painted with a conventional paint	Cooling or heating needs reduction, less maintenance
	Self-cleaning			
	Insulating			
	Anti-mold			

TECHNOLOGY	LIST	BRIEF DESCRIPTION	APPLICATION	EXPECTED ENERGY SAVINGS
<b>Daylight strategies</b>	External solar lamellas	Static opaque lamella, adjustable to climate and indoor requirements by different distances of the lamellas	In front of vertical glass areas of the common centre zone, like restaurants, etc.	Energy savings in cooling, simultaneously reasonable energy demand for artificial light
	Modular roof, solar-harvesting grid	Grid structure that harvests direct sun while redirecting it in uncritical directions (avoiding glare); part of an overall concept, called modular roof, which can react to project-specific conditions (e.g. position of sale area, climate, etc.)	Main atria in common centre area	Direct sun might be used for heating in winter or in cold regions, not blocking, but redirecting the sun. Modular roof concept allows to design the roof according to its lighting demand and passive heat gains
	Light-tube	Daylight system which guides daylight from the roof into the room with excellent light transmission properties; improvement in visual comfort and benefits for higher turnover	Shops, common centre area	Savings by reduced use of artificial light
<b>Thermo-acoustic envelope components</b>	Flexible mat without finish			
	Flexible mat with additional sound absorbing layer			
	Flexible mat with additional finish			
	Flexible mat with additional sound absorbing layer and with additional finish			
<b>iBEMS (intelligent Building Energy Management System)</b>	HVAC + shading + artificial lights + natural ventilation + energy and environmental conditions monitoring + refrigeration system	The iBEMS allows communication between the installed systems and the respective sensors. It incorporates control rules (higher and lower level) for the optimisation of the system; in parallel, it measures the energy consumption of the connected systems to calculate their efficiency	All areas of demo case and reference buildings	The iBEMS maximises the energy saving by monitoring the performance and consumption of all the connected subsystems while guaranteeing their efficiency; the expected energy savings is related to the managed systems
<b>Electrical Energy storage</b>	PV + battery	Use of PV + battery storage to increase self-consumption of the shopping centre or to cover dedicated load or EV-charger	PVs on the roof of the shopping centre or in the parking area on the roof platform. Suitable area for battery (space, ventilation, temperature)	Increase of self-produced and self-consumed energy
	PV + H2	H2 for hydrogen car mobility or with FC for electricity consumption	Suitable area for H2 (space, ventilation, temperature, security issues)	possibility to offer H2 gas station to cars using PV-generated power
	PV + storage + electromobility	Use the storage for EV-charger	Possible station in the shopping centre parking area (open or close)	Possibility to offer recharge for e-cars using PV-generated power

TECHNOLOGY	LIST	BRIEF DESCRIPTION	APPLICATION	EXPECTED ENERGY SAVINGS
Refrigeration system	Transcritical system for warm climate	Transcritical system able to manage high external temperatures in an efficient way	Warm climates	No significant energy savings but lower environmental impact due to the use of a natural refrigerant instead of a synthetic one
	Transcritical system with HVAC Integration	The refrigeration system actively recovers the waste heat of the condensing side to satisfy heating and cooling demand	Small supermarkets in warm climates	Enhancement of the overall efficiency recovering waste heat from refrigeration
	Transcritical system with solar Integration	Solar and refrigeration systems work together to maximize the heat production and run the adsorption machine in stable conditions; excessive solar thermal power used for refrigeration to sub-cool itself	Supermarkets in warm climates	Integration with solar technology, reducing pay-back time
	Transcritical heat pump for Heating and/or Domestic Hot Water (DHW)	Heat pump with natural refrigerant producing heat and DHW	Supermarkets	Natural solution for heating and DHW system
	Thermal storage to manage refrigeration load peak	Fire-prevention tanks used to shave cooling peak request; inertia principle	Shopping centres with fire-prevention tanks	Thermal peak-shave
	Integral refrigeration based on a water loop within the refrigeration system	Integral cabinet with water-condensed system and a water loop able to remove the heat outside the store	Supermarkets	Easy division of the energy consumed between final users; limited refrigerant charge; independent behaviour of each cooling device maximising efficiency in presence of different types of load
	HVAC&R water loop distribution inside the building	Water loop system linked with w/a heat pump, balanced to maintain stable temperature during year	Supermarkets	Easy division of the energy consumed between final users; limited refrigerant charge; independent behaviour of each cooling device

TECHNOLOGY	LIST	BRIEF DESCRIPTION	APPLICATION	EXPECTED ENERGY SAVINGS
<b>Artificial lighting systems</b>	General Retail Lighting (GRL)	Energy-efficient light source: LED, precise distribution by 7 downlights, backlit area to prevent glare, 3 light colours, constant light-output control	Common centre area, main traffic zones in larger shops	Dependent on technologies replaced and on iBEMS features (like light colours or cleaning schedules)
	Projector/mirror system	Energy-efficient light source: LED, improved maintenance (longer life time, easy-accessible luminaires), pleasant "architectural" light, glass roof visually closed at night by mirrors	Main atria in common shopping centre area	Dependent on technologies replaced
	LED wall washer	Energy-efficient light source: LED, precise illumination for wall-arranged merchandise, longitudinal glare protection	In shops, wall-arranged merchandise	Dependent on technologies replaced and on iBEMS features (like light colours or cleaning schedules)
	Integration of LED artificial light in a light tube	Supplement of artificial light to daylight via 24 micro LED luminaires at the upper rim of the light tube, using its distribution body	Shops, common shopping centre area	Energy-efficient daylight dependent control
	Green lighting box	Turn-key ready control solution for shops that implement high-quality lighting scenes for retail applications, energy-saving strategies and monitoring possibilities	Devices (control unit, shop control panel, DALI gateways) quickly installed in shops, possible connection to central iBEMS	Key instruments (algorithm plus device) to control energy-efficient lighting scenes, e.g. schedules, daylight-dependent control of artificial light etc.
<b>Building Integrated Electric Mobility system</b>	Charging stations	The charging station provides a refuelling point for Electric Vehicles (EVs). The required power can be provided by either the grid, or a storage system (hydrogen or chemical); the electric vehicles can be customers' or shopping centre employees'	Parking area; the number of plugs and the power are related to the diffusion of the BEV (Battery Electric Vehicle), mainly driven by national incentives	The savings depend on the number of cars charged and the type of energy used (e.g. renewable energy); due to the BIEM, it is possible to manage the flux of power in order to maximise the usage of RES
	Electrolyser and storage	The hydrogen storage system transforms the available power in gas and stores it for future use; the inverse transformation provides base power for charging EVs	Parking area with a natural gas grid connection to store hydrogen	The energy savings are related to the type of energy used in the electrolyser
	Hydrogen mobility	Parallel to the previous description, the stored hydrogen can be used to refuel hydrogen cars, owned by customers or shopping centre employees	Parking areas in countries with possibility of hydrogen mobility diffusion	The energy savings are related to the type of energy used in the electrolyser
	Battery for industrial vehicles	The chemical storage system using batteries is applied to store excessive energy from the renewable energy system or low-cost energy from the grid. When needed, the energy is transferred back to the grid or to EVs.	Parking area	

	 Ayuntamiento de Valladolid		INRES	 Alleanza 3.0
	 ITM POWER Energy Storage   Clean Fuel			
				
	 DS CONSULTING PROCESS & ORGANIZATION	 TU WIEN TECHNISCHE UNIVERSITÄT WIEN Vienna University of Technology	 SOLID solarinstallation+design	
				 ams ADVANCED MANAGEMENT SOLUTIONS

The project **CommONEnergy** (2013-2017) focuses on transforming shopping centres into energy efficient and high-indoor-environmental-quality buildings, by developing smart renovation strategies and solutions, supporting their implementation, and assessing their environmental and social impact.

**CommONEnergy** in numbers:

- 3 demo cases, 8 reference buildings & 23 partners from across Europe
- 25 technologies developed and installed in 4 years
- Up to 75% reduction of energy demand, leading to costs reduction
- A target payback time up to 7 years



**CommONEnergy**

The research leading to these results has received funding from the European Community's Seventh Framework Programme (FP7/2007-2013) under grant agreement n. 608678. The content of this document does not reflect the official opinion of the European Union. Responsibility for the information and views expressed in the document lies entirely with the authors.

