

Åse Lekang Sørensen, Mads Mysen, Inger Andresen, Bjarte Hårklau  
and Arild Lunde

# The Visund office building, Haakonsvern, Bergen As Built Report



SINTEF Academic Press

Åse Lekang Sørensen, Mads Mysen, Inger Andresen, Bjarte Hårklau and Arild Lunde

# **The Visund office building, Haakonsvern, Bergen**

As-built report



ZEB Project report 38 – 2017

ZEB Project report no 36

Åse Lekang Sørensen <sup>2)</sup>, Mads Mysen <sup>2)</sup>, Inger Andresen <sup>1)</sup>, Bjarte Hårklau <sup>3)</sup>, Arild Lunde <sup>4)</sup>

**The Visund office building, Håkonsvern, Bergen**

**As-built report**

Keywords:

Zero Emission Buildings, Case Study, Evaluation

Photo/illustration on front page: Cover illustration is from Forsvarsbygg / Hundven-Clements Photography.

ISSN 1893-157X (online)

ISSN 1893-1561

ISBN 978-82-536-1557-8 (pdf)

© Copyright SINTEF Academic Press and Norwegian University of Science and Technology 2017

The material in this publication is covered by the provisions of the Norwegian Copyright Act. Without any special agreement with SINTEF Academic Press and Norwegian University of Science and Technology, any copying and making available of the material is only allowed to the extent that this is permitted by law or allowed through an agreement with Kopinor, the Reproduction Rights Organisation for Norway. Any use contrary to legislation or an agreement may lead to a liability for damages and confiscation, and may be punished by fines or imprisonment.

**Norwegian University of Science and Technology <sup>1)</sup>**

N-7491 Trondheim

Tel: +47 73 59 50 00

[www.ntnu.no](http://www.ntnu.no)

[www.zeb.no](http://www.zeb.no)

**Veidekke <sup>3)</sup>**

Skabos vei 4, 0278 Oslo

Tel: +47 21 05 50 00

[www.veidekke.no](http://www.veidekke.no)

**SINTEF Building and Infrastructure Trondheim <sup>2)</sup>**

Høgskoleringen 7 b, Postbox 4760 Sluppen, N-7465 Trondheim

Tel: +47 73 59 30 00

[www.sintef.no/byggforsk](http://www.sintef.no/byggforsk)

[www.zeb.no](http://www.zeb.no)

**Forsvarsbygg <sup>4)</sup>**

Postboks 405 Sentrum, 0103 Oslo

Tel: +47 815 70 400

[www.forsvarsbygg.no](http://www.forsvarsbygg.no)

**SINTEF Academic Press**

c/o SINTEF Building and Infrastructure Oslo

Forskningsveien 3 B, Postbox 124 Blindern, N-0314 Oslo

Tel: +47 73 59 30 00, Fax: +47 22 69 94 38

[www.sintef.no/byggforsk](http://www.sintef.no/byggforsk)

[www.sintefbok.no](http://www.sintefbok.no)

## Acknowledgement

---

This report has been written within the *Research Centre on Zero Emission Buildings (ZEB)*. The authors gratefully acknowledge the support from the Research Council of Norway, BNL – Federation of construction industries, Brødrene Dahl, ByBo, DiBK – Norwegian Building Authority, Caverion Norge AS, DuPont, Entra, Forsvarsbygg, Glava, Husbanken, Isola, Multiconsult, NorDan, Norsk Teknologi, Protan, SAPA Building Systems, Skanska, Snøhetta, Statsbygg, Sør-Trøndelag Fylkeskommune, and Weber.

## Abstract

---

The Visund office building is a pilot project within the Research Centre on Zero Emission Buildings (ZEB) in Norway. The building has 2031 m<sup>2</sup> of heated floor area and is located at Haakonsværn, about 15 km from the centre of Bergen, Norway. The building is owned by the Norwegian Defence Estates Agency (Forsvarsbygg) and the main contractor was Veidekke. The building has been in operation since January 2016.

The design aimed at meeting the ZEB-criterion of net zero emission balance, excluding energy for appliances. The compact and simple building form has been carefully planned, giving an energy efficient and airtight building envelope with good daylight conditions. Heating and cooling is provided by a local seawater-based heat pump. The temperature, as well as the ventilation and lighting systems are demand controlled. A photovoltaic system installed on the roof is generating electricity.

The energy performance has been closely monitored and the energy measurements during the first year corresponds well with the predicted energy use and required indoor climate performance. Energy need for lighting is an exception and was higher than predicted in 2016. Improvements have been made during the year to reduce this energy post. The indoor temperature has been higher than estimated in the calculations, with an average of 22.9°C in 2016, compared with estimated 21°C. The energy generation from the PV plant corresponds well to the predicted energy generation.

To satisfy the ZEB-goal, the PV plant has to generate as much electricity as the energy delivered to the building, except the energy needed for appliances. In 2016, the delivered energy during the year was 45.1 kWh/m<sup>2</sup> and energy generation from the PV plant was 27.5 kWh/m<sup>2</sup>, giving a net delivered energy of 17.6 kWh/m<sup>2</sup>; 4.1 kWh/m<sup>2</sup> more than the energy need for appliances during the same year. The ZEB-goal was therefore not completely achieved during the first year of operation. Delivered energy was 7% higher than the predicted value, achieving the contract requirement of maximum 20%.

Given that this was the initial operational year, with a number of improvements, it seems likely that the Visund office building later will achieve the ZEB-goal of net zero emission balance for building operation during a year.

The Visund office building project shows that it is possible to build a net zero emission office building in Bergen with commercially available products and traditional design and construction process. A high focus on clear and shared goals, contract based economic incentives, robust building design and technology choices, energy monitoring, and follow-up measures have been key factors to achieve the goals.

## Contents

---

<b>1. INTRODUCTION</b>	<b>6</b>
<b>2. BUILDING DESIGN</b>	<b>7</b>
2.1 BUILDING LOCATION AND FORM	7
2.2 BUILDING ENVELOPE	10
2.3 BUILDING DETAILS	12
<b>3. BUILDING SERVICES</b>	<b>15</b>
3.1 VENTILATION	15
3.2 LIGHTING AND SUN SHADING SYSTEM	16
3.2.1 Daylight calculations	16
3.2.2 The lighting system	17
3.2.3 Sun shading system	17
3.3 ELEVATOR	18
<b>4. ENERGY SUPPLY SYSTEMS</b>	<b>19</b>
4.1 ENERGY SYSTEM DESIGN	19
4.2 ENERGY BUDGET	22
4.3 THE PHOTOVOLTAIC SYSTEM	23
4.4 CONTROL SYSTEM	24
<b>5. OPERATIONAL BUILDING PERFORMANCE</b>	<b>26</b>
5.1 ENERGY MEASUREMENTS	26
5.1.1 Introduction to the energy measurements	26
5.1.2 Energy performance	27
5.1.3 Produced electricity	29
5.2 INDOOR CLIMATE PERFORMANCE	29
<b>6. THE ZEB BALANCE</b>	<b>31</b>
<b>7. DESIGN AND CONSTRUCTION PROCESS</b>	<b>32</b>
7.1 THE DESIGN PROCESS	32
7.2 THE CONSTRUCTION PROCESS	32
<b>8. DESIGN AND CONSTRUCTION COSTS</b>	<b>35</b>
<b>9. SUMMARY AND CONCLUSIONS</b>	<b>36</b>
<b>10. REFERENCES</b>	<b>37</b>

## 1. Introduction

Visund is a new office building of 2031 m<sup>2</sup> heated floor area owned by the Norwegian Defence Estates Agency (Forsvarsbygg). The building is located at Haakonsvern, about 15 km from the centre of Bergen, Norway, as illustrated in Figure 2.3.

The building design aimed at meeting the ZEB criterion of net zero energy and GHG emission balance for building operation during a year (ZEB-O±EQ), as described by Fufa et al. (2016). The energy for operation of appliances (computers, printers, etc.) is not included in the balance.



Figure 1.1 The south (long) and west (short) façade of the building. Photo: Forsvarsbygg / Hundven-Clements Photography.

### Key Data

<i>Name and address</i>	Visund, Haakonsvern, 5173 Bergen, Norway.
<i>Location data</i>	Latitude 60.38°N, Longitude 5.33°E.
<i>Building type</i>	A three storey office block.
<i>Heated floor area</i>	2031 m <sup>2</sup>
<i>Project type and ambition level</i>	New construction
<i>Building owner / Tenant</i>	Norwegian Defence Estate Agency (Forsvarsbygg) / Defense Logistics Organization
<i>Design team</i>	Norwegian Defenc Estate Agency (client), LINK Arkitektur (architect preliminary project), ABO Architects (detailed design), Multiconsult (consultants preliminary project), COWI and Rambøll (consultants detailed design), Veidekke (contractor), ZEB centre (energy specialists).
<i>Design phase / Construction phase</i>	2012-2013 / 2014-2015
<i>Opening</i>	December 2015

## 2. Building Design

---

### 2.1 Building location and form

The project site Haakonsvern is located at the west coast of Norway. The yearly mean ambient temperature is 7.5°C, and the yearly total solar horizontal radiation is 815 kWh/m<sup>2</sup>. Winter design temperature is -11.7°C and summer design temperature is 18.9°C.

The Visund office building has three floors and a heated floor area of 2031m<sup>2</sup>. The south façade faces the sea, while on the north side of the building there is a small hill. A compact and simple building form was chosen in order to minimize heat losses, avoiding air leakages and minimizing costs (Andresen et al., 2012). The work space (around 100 work places) is organized as a mix of open space offices and cell offices.

Good daylight conditions in the occupied spaces were obtained by placing offices and primary rooms along the facades, while secondary rooms were placed in the interior. Windows were designed to maximize daylight conditions.



Figure 2.1 Left: Offices in Visund. Photo: Å. V. Sjørusen, Forsvarsbygg. Right: The entrance of the Visund office building. Photo: Forsvarsbygg / Hundven-Clements Photography.



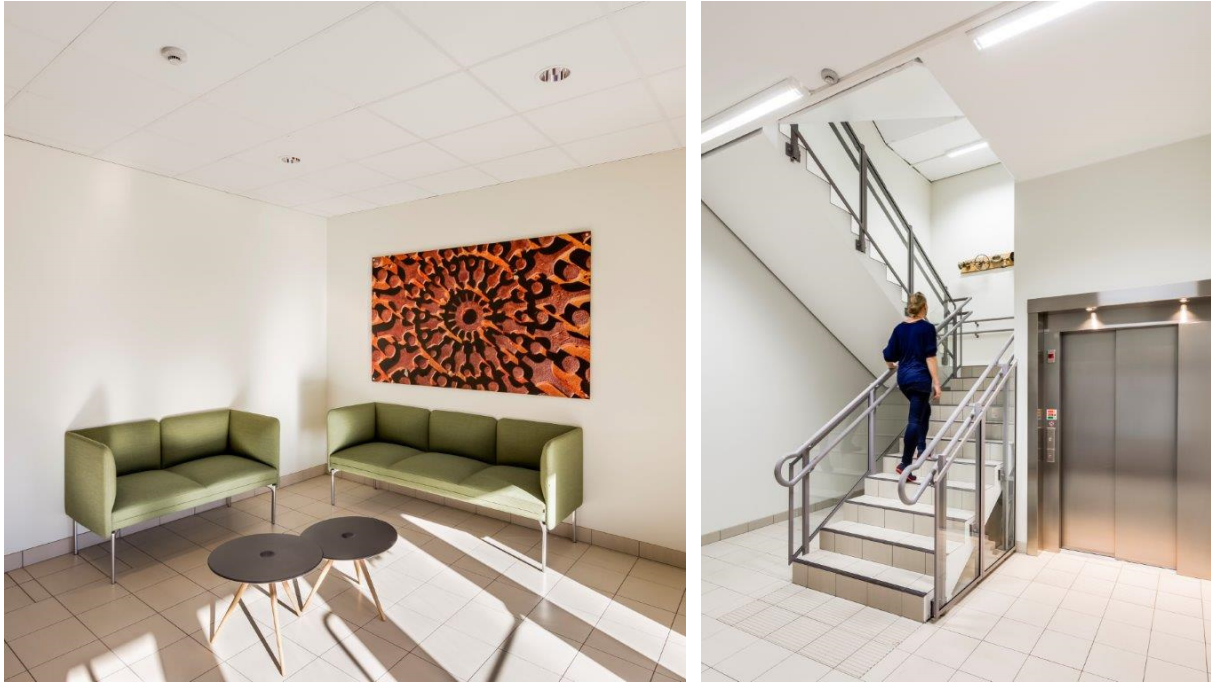

Figure 2.2 The Visund office building. Photo: Forsvarsbygg / Hundven-Clements Photography.

Figure 2.3 shows the location of the Visund office building. Figure 2.4 to Figure 2.7 illustrates the floor plans and the section of the office building.

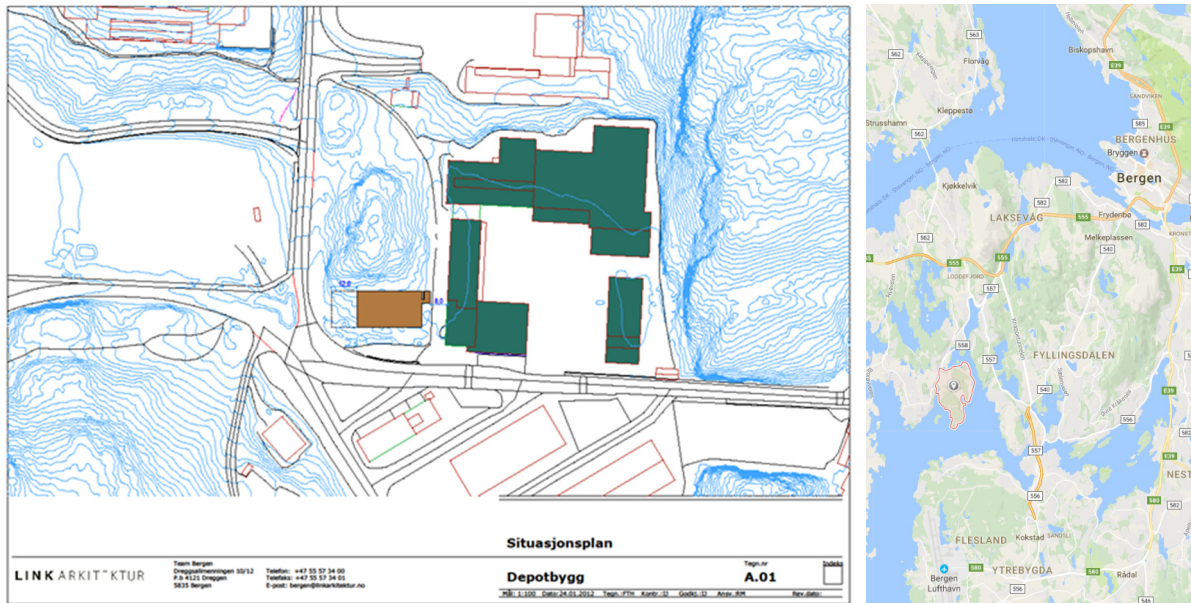

Figure 2.3 Site plan indicating the footprint of the Visund building in orange. Illustration: LINK Arkitektur (left), Google maps (right).

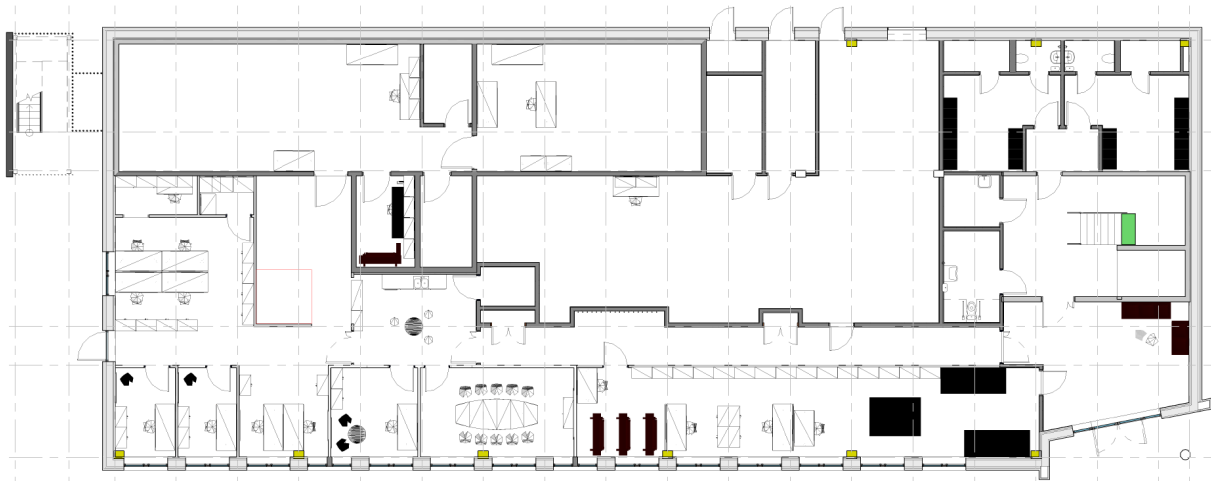

Figure 2.4 Floor plan, 1<sup>st</sup> floor. Illustration: ABO Plan og Arkitektur.

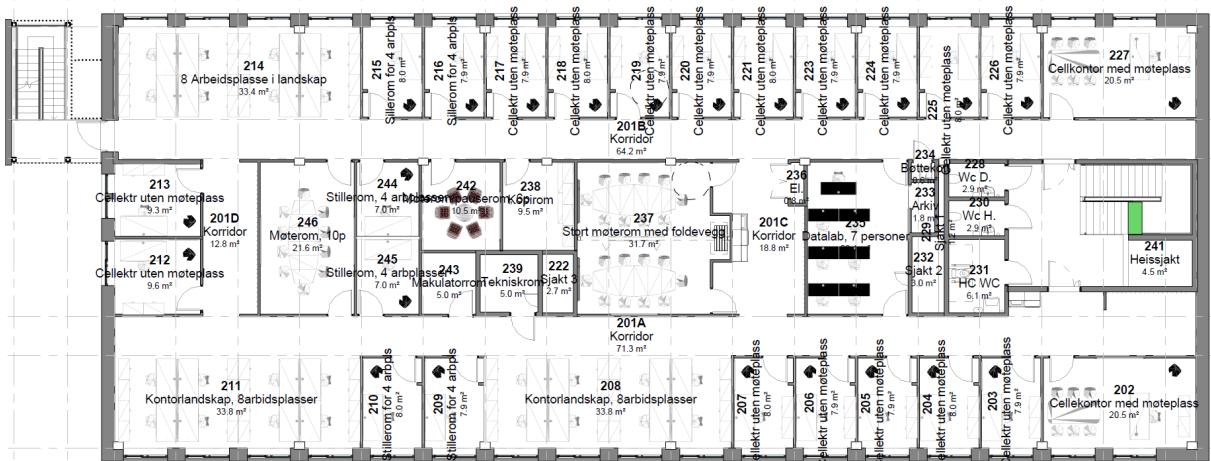

Figure 2.5 Floor plan, 2<sup>nd</sup> floor. Illustration: ABO Plan og Arkitektur.

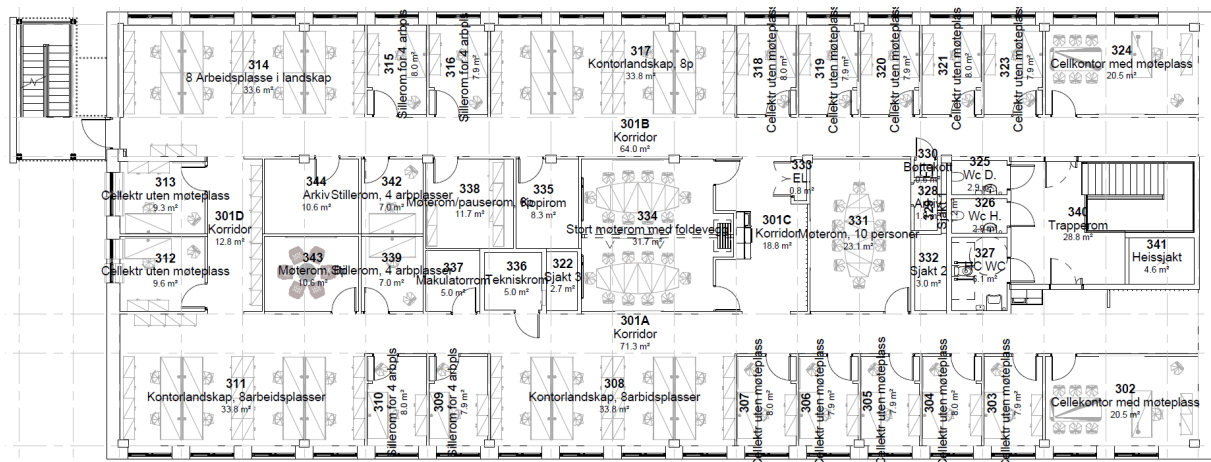

Figure 2.6 Floor plan, 3<sup>rd</sup> floor. Illustration: ABO Plan og Arkitektur.

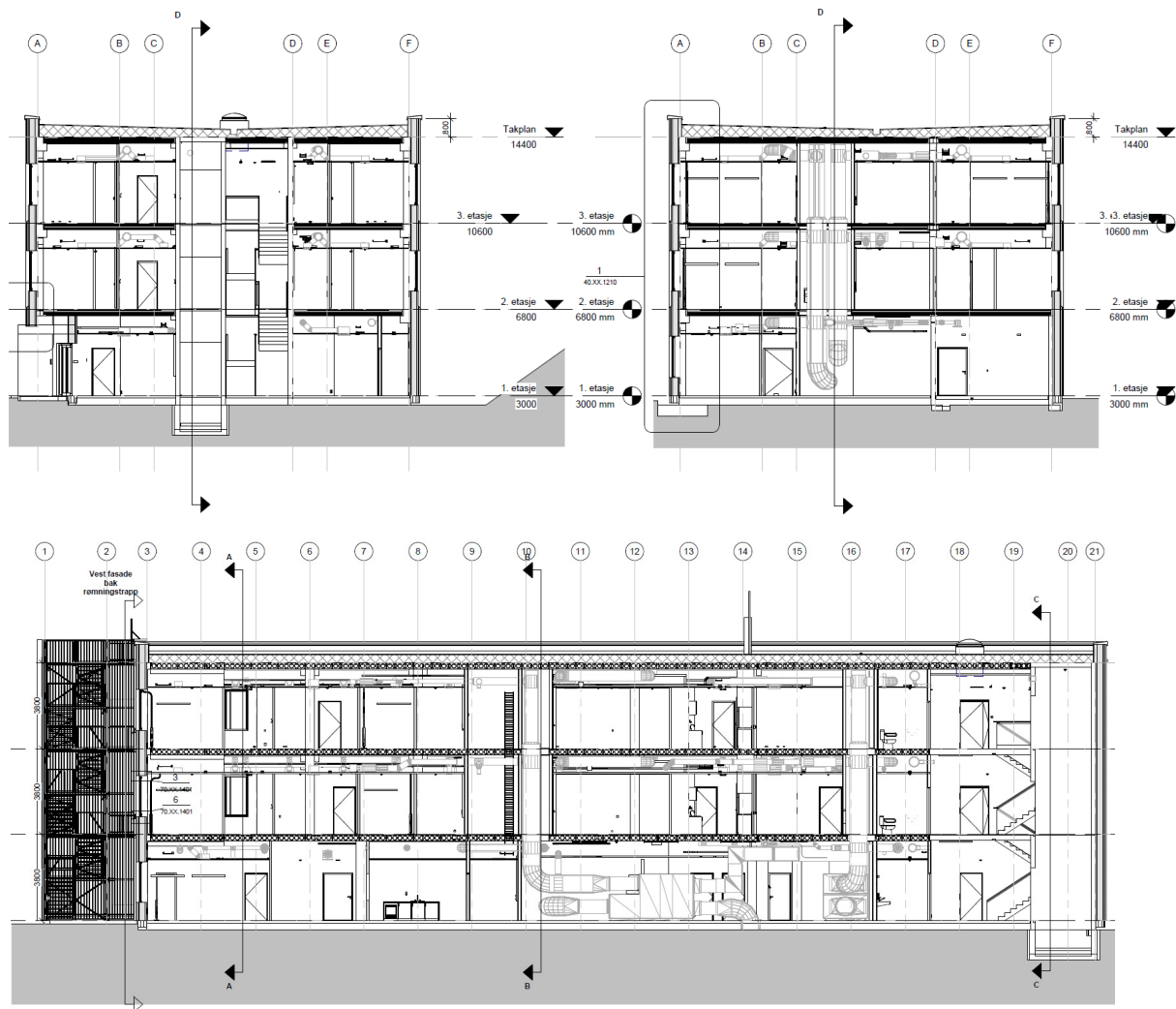

Figure 2.7 Section illustrations of the office building. Illustration: ABO Plan og Arkitektur.

## 2.2 Building envelope

The structural system of the building was designed to use hollow core concrete slabs and steel columns. The columns were placed on the interior side of the continuous thermal insulation layer to minimize thermal bridges. The exterior walls have 200 mm of rigid mineral wool insulation ( $\lambda = 0,033$ ) on the outside and 100 mm of insulation between wooden studs on the interior side (see Figure 2.8 and building details in Chapter 2.3). The windows have exterior automatically controlled shading towards south, east and west.

The technical specification of the building envelope and structure is shown in Table 2.1. The air leakage number was measured to 0.11 ACH as built at 50 Pa difference, which is extremely low, see Figure 2.9.

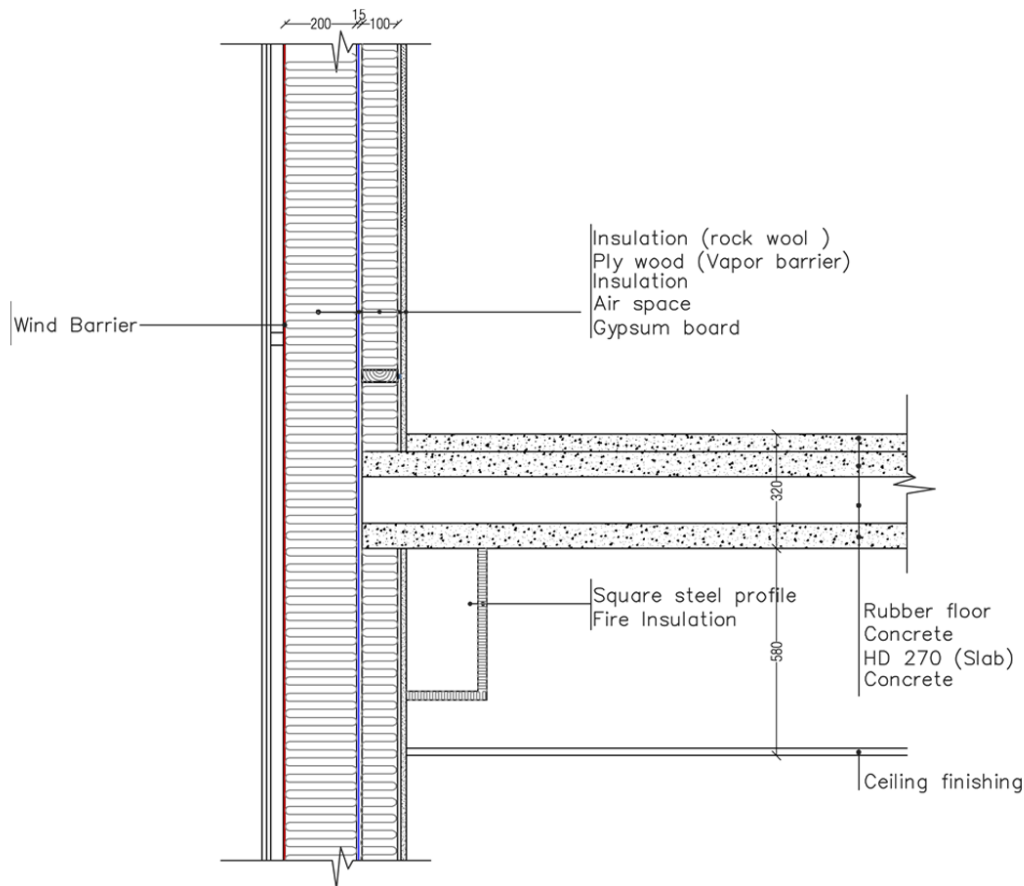

Figure 2.8 Cross section showing the structural system and the thermal insulation and wind barrier of the exterior walls. Illustration: Shabnam Arbab.

Table 2.1 Specification of the thermal characteristics of the building envelope and structure.

Exterior walls	$U = 0.12 \text{ W}/(\text{m}^2\text{K})$	~ 200 + 100 mm mineral wool
Roof	$U = 0.09 \text{ W}/(\text{m}^2\text{K})$	~ 450 mm mineral wool
Slab on ground	$U = 0.08 \text{ W}/(\text{m}^2\text{K})$	~ 300 mm mineral wool, included heat resistance of ground
Windows and doors	$U = 0.85 \text{ W}/(\text{m}^2\text{K})$	Average value. Triple glazing with 2 LE-layers and argon gas filling, insulated frame and sash. G-value 0.5, Lt-value 0.7. Window type: Nordan N-tech Passiv
Normalized U-value for thermal bridges	$0.03 \text{ W}/(\text{m}^2\text{K})$	Simple building envelope, carefully planned details, quality control of construction
Air leakage number at 50 Pa	0.4 ACH (design), 0.1 ACH (measured)	Simple building envelope, carefully planned details, quality control of construction

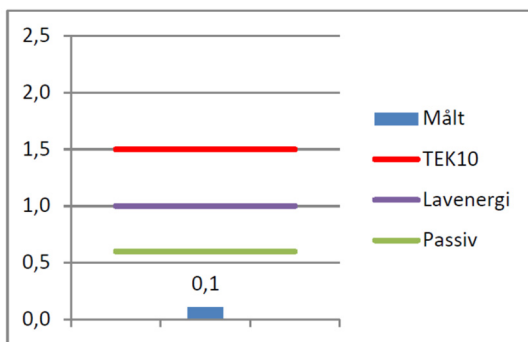

Figure 2.9 Measured air leakage number compared to the values in the national building code (TEK) and the low energy and passive house buildings standards (Grimnes, 2015)

## 2.3 Building details

Figure 2.10 to Figure 2.13 show building details of the windows, door, exterior walls and parapet.

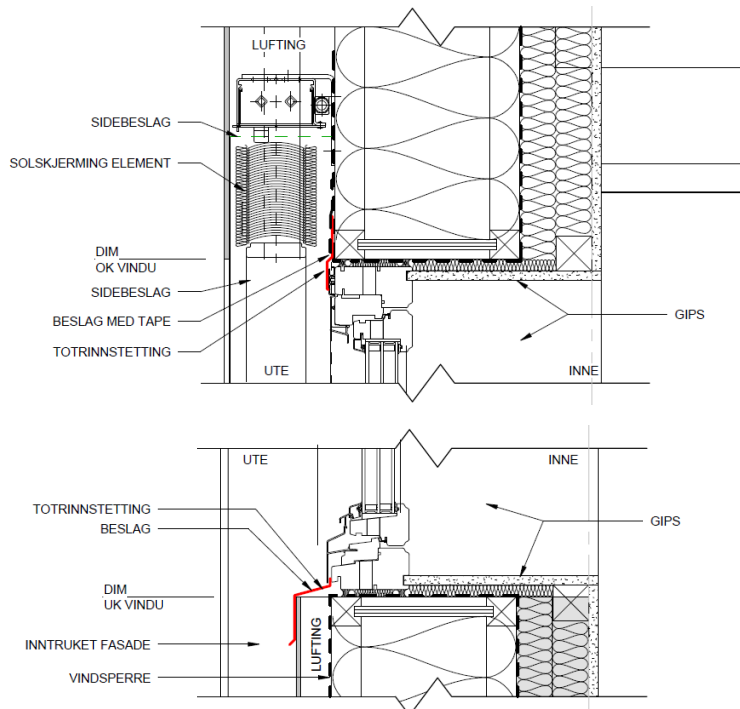

Figure 2.10 Details of the windows on the south wall, with sun shading. Illustration: ABO Plan og Arkitektur.

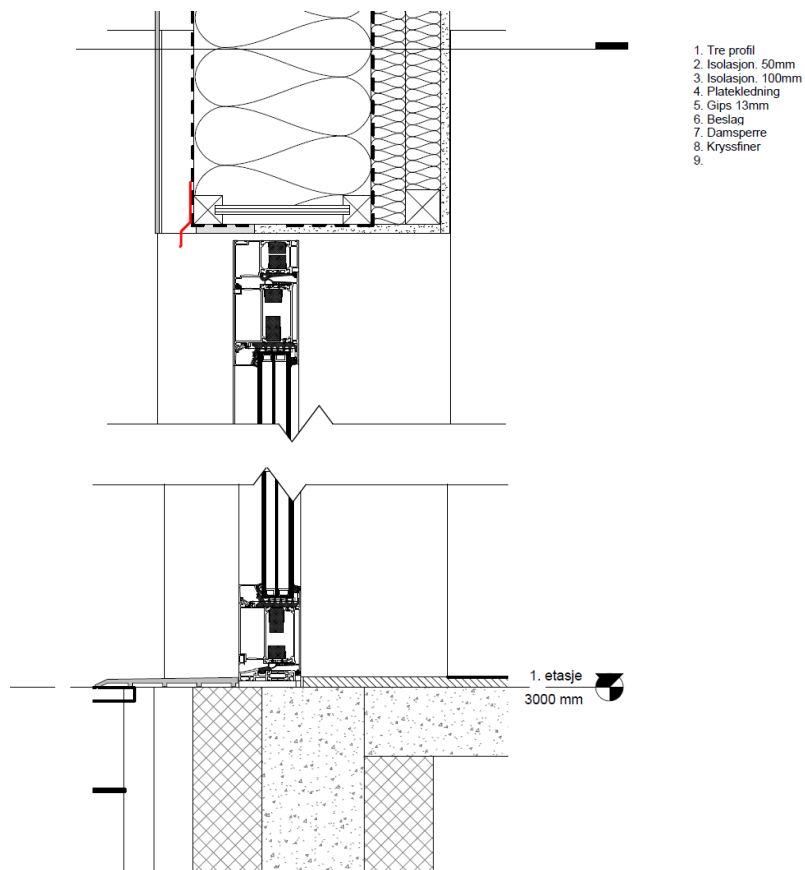

Figure 2.11 Details of the exterior door. Illustration: ABO Plan og Arkitektur.

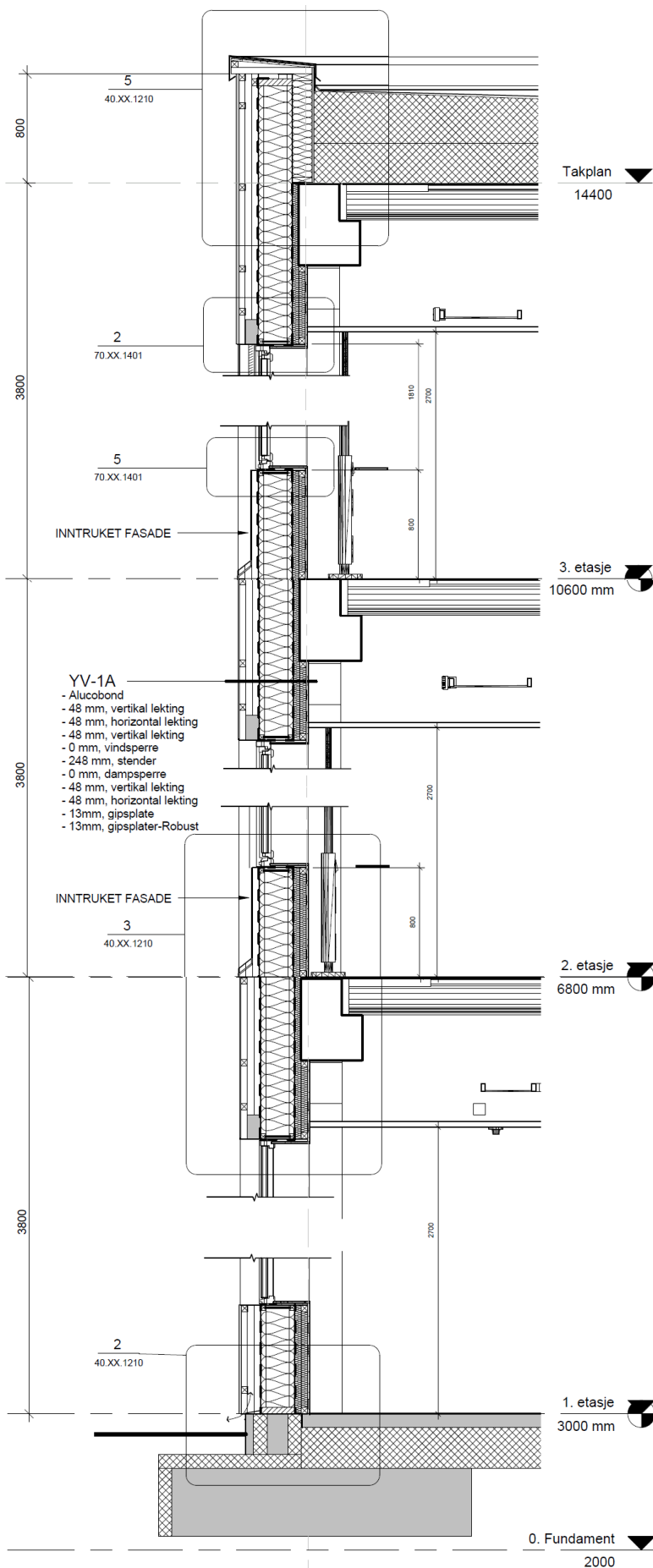

Figure 2.12 Cross section showing the exterior walls. Illustration: ABO Plan og Arkitektur.

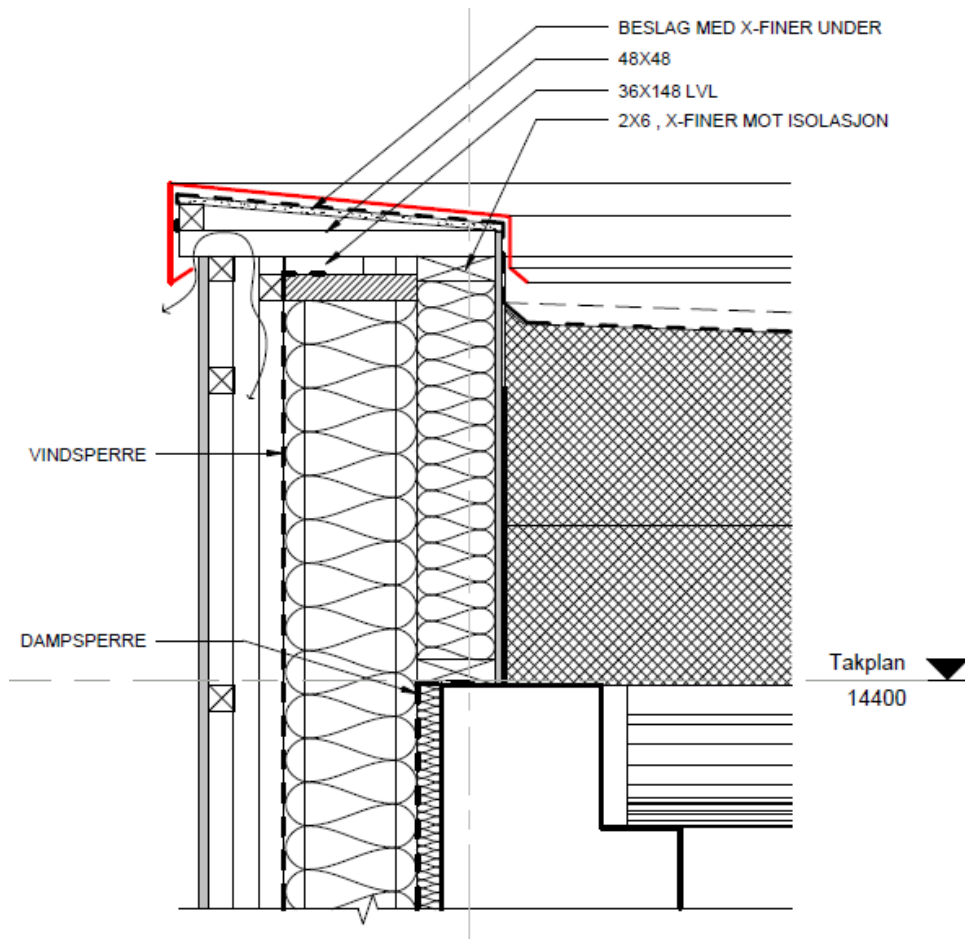

Figure 2.13 Details of the parapet. Illustration: ABO Plan og Arkitektur.

## 3. Building Services

### 3.1 Ventilation

Different ventilation concepts were discussed during the early phases of design. A main goal was to be able to minimize the energy use for fans, heating, and cooling by passive strategies and effective demand control. Natural ventilation by automatically controlled window opening was considered, but was not chosen due to cost, maintenance, and security reasons. However, the possibility for the users to open the windows was considered important for user satisfaction. It is a requirement according to the Norwegian building code and was recommended for the rooms without special security restrictions.

The ventilation system had to be designed for the given room layout with many small offices with suspended ceilings. Maximum flexibility and controllability were important design goals. Hence, the chosen ventilation strategy was based on VAV with *active supply air diffusers* (Maripuu, 2009). The diffusers (Lindinvent) contain temperature sensors and motion detectors and may be coupled to CO<sub>2</sub>-sensors. The active air diffusers have built-in controls that automatically measure and control the air volumes according to human presence or temperature below the diffuser. The air volume is controlled by a small motor in the diffuser; it adjusts the lamella openings, making the air volumes change while the air velocity in the opening remains quite constant. This enables precise demand control and consequently a minimization of energy use for heating, cooling and ventilation fans. Three separate air-handling-units were selected to serve north, south, and interior zone, respectively.

The ventilation was designed for an average ventilation rate of 6 m<sup>3</sup>/(m<sup>2</sup>h) during operating hours, but the real average was 8.3 m<sup>3</sup>/(m<sup>2</sup>h) the first operating year. Design value of the Specific Fan Power was 1.0 kW/m<sup>3</sup>/s during operating hours, while the real value was 0.49 in average during the first year of operation. Design temperature efficiency of the heat exchanger was 85%.

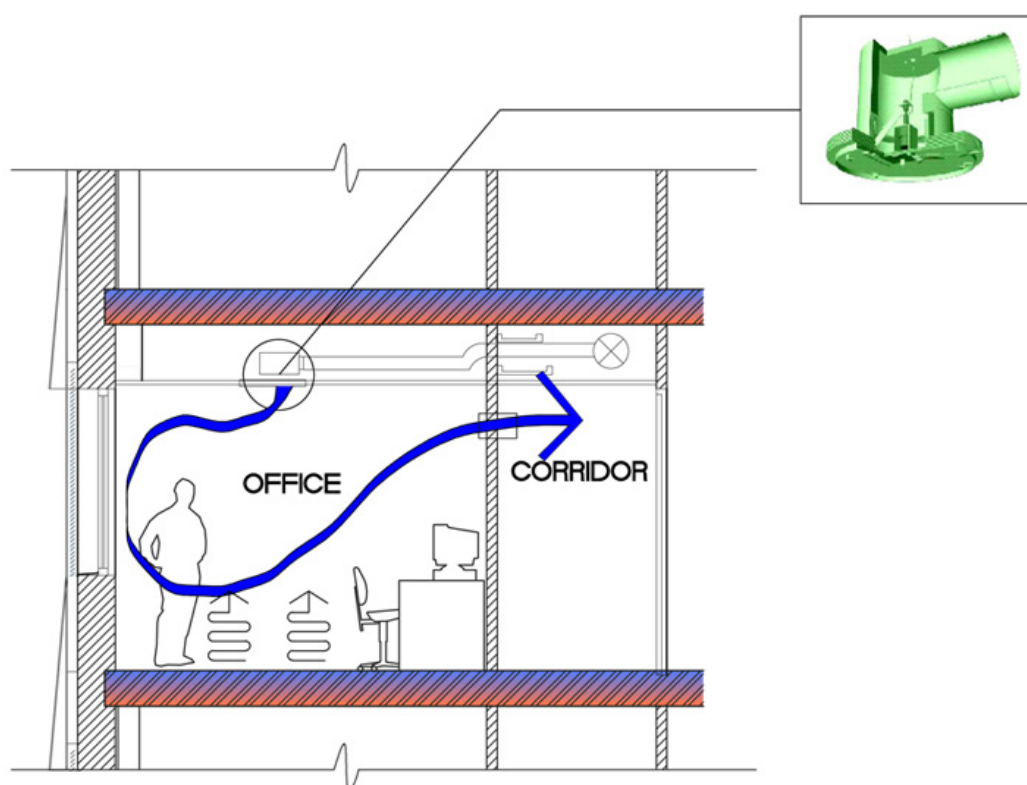

Figure 3.1 Ventilation principle. Illustration: Shabnam Arbab.



## 3.2 Lighting and sun shading system

### 3.2.1 Daylight calculations

During the concept design phase, daylight calculations were carried out for different window configurations in order to maximize the daylight penetration and reduce the need for electric lighting. Due to the shallow depth of the occupied zones, the daylight conditions within the space are potentially very good. Figure 3.2 shows the result of daylight calculations for the final window design. A section of the 1<sup>st</sup> floor of the building was modelled. The section has dimensions 7.2 m x 17 m, and consists of 3 offices along the north and south facades. Each of the offices has a window opening of 1.79 m x 1.74 m, of which the frame and sash comprises 20%. The windows have triple glazing with two low-E coatings and argon gas filling, with a light transmission of 70%. Between the offices and the corridors, there are single glazed interior walls almost from floor to ceiling, i.e. with a parapet of 20 cm.

The north facing windows receive some shading from the terrain. The south facing windows are not shaded by the terrain but have been modelled with fixed horizontal lamellas in the upper part of the window to allow for daylight penetration into the room when the exterior movable blinds are activated in the lower part of the window. Interior walls and ceilings have been modelled with a light reflection of 70%, while the floor has a light reflection of 30%. The daylight calculations were carried out by the program DIAL+ Lighting ([www.estia.ch](http://www.estia.ch)). The program does not have the possibility of modelling interior transparent walls, thus the interior glass walls were omitted in the model. However, an approximate estimate of the effect of the interior glass walls may be obtained by multiplying the resulting daylight factors behind the walls by 0.9.

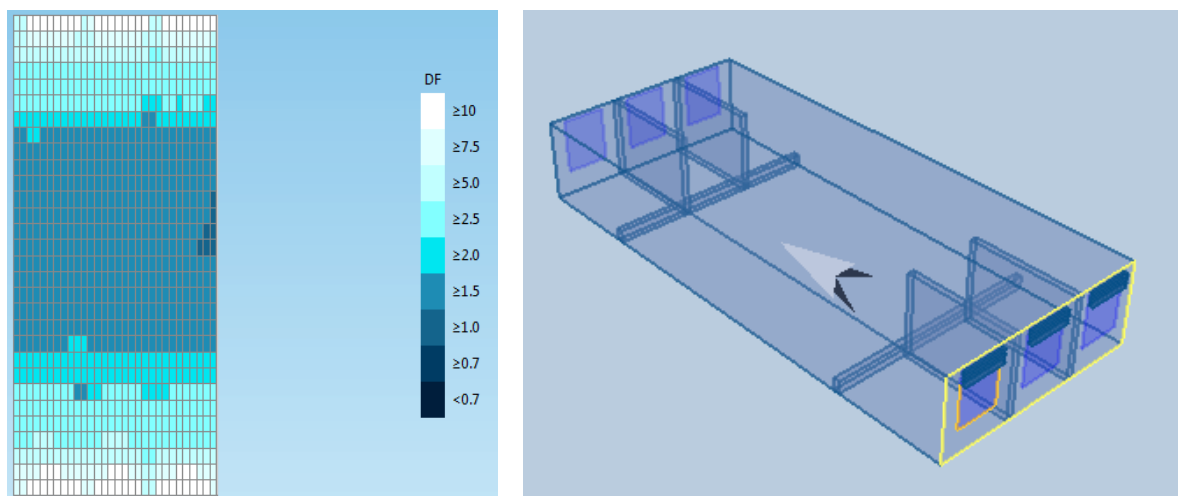

Figure 3.2 Left: The calculated daylight distribution (DF) on the work plane (North direction is up). Right: The modeled building section, the arrow showing direction north. Source: (Andresen et al., 2012)

The daylight autonomy has been calculated to get an estimate of the potential energy savings by dimming of the electric lighting. Daylight autonomy is defined as the fraction of the occupied times per year, when the required minimum illuminance level can be maintained by daylight alone. In contrast to the daylight factor, the daylight autonomy considers all sky conditions throughout the year. For example, a daylight autonomy of 70% means that the occupant can potentially work 70% of the year by daylight alone. The daylight autonomy calculation done by DIAL+ includes only overcast days (diffuse illumination), since it is assumed that the movable solar shading is activated in direct sun.

Figure 3.3 shows the results of daylight autonomy calculations for the offices and corridors. The required illuminance level is set to 500 lux for the offices and 150 lux for the corridors. The figures show that electric lighting can potentially be switched off for at least 60% of the time. This indicates that by

installing a daylight control system for the electric lighting, this may reduce the energy use for lighting by more than 60%, and even more if a continuous dimming system is installed.

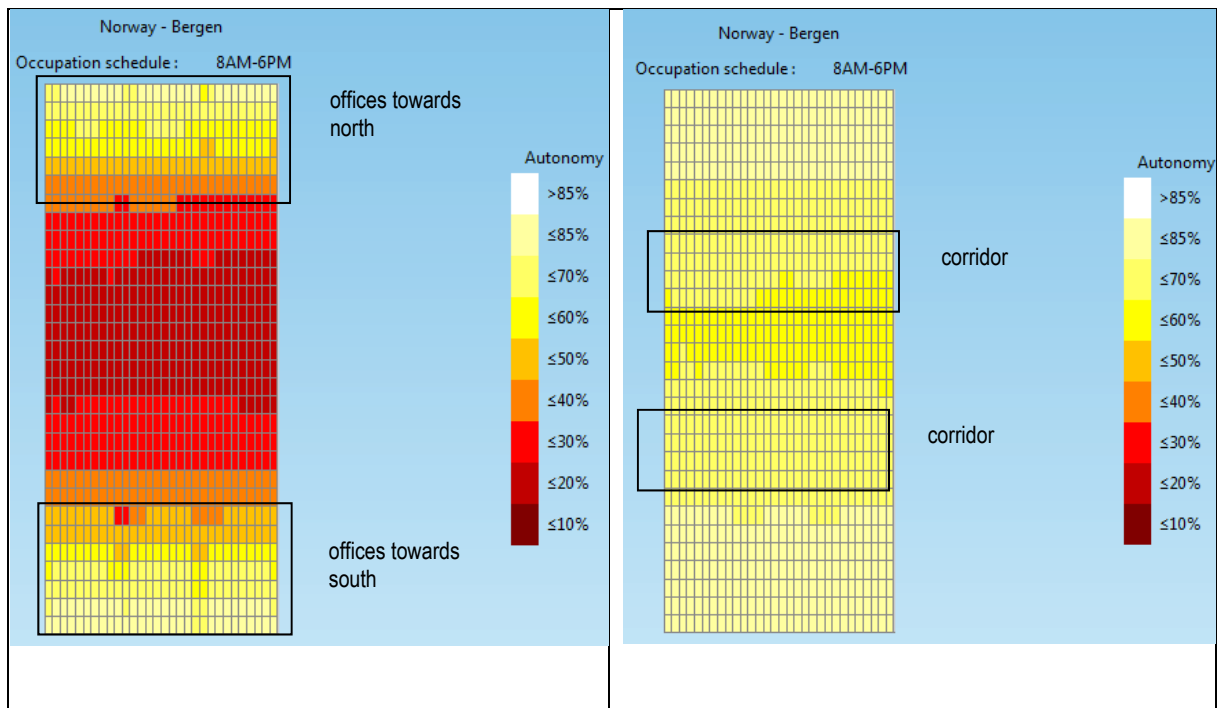

Figure 3.3 Left: Daylight autonomy in offices, with required illumination 500 lux. Right: Daylight autonomy in corridors, with required illumination 150 lux. Source: (Andresen et al., 2012)

### 3.2.2 The lighting system

The installed lighting system is controlled by DALI (Digital Addressable Lighting Interface), according to occupancy and daylight level.

The lighting system is based on a combination of T5 fluorescent tubes (in offices) and LEDs (in hallways, meeting rooms and technical rooms). The general lighting level in the office areas is kept relatively low, at 300 lux, while desk lamps is provided for individual task lighting.

During the first operational year there has been challenges with visual comfort and the daylight sensor controlled lighting system. The challenges appear to result from glare from a neighbouring building, reflecting interior surfaces and influence of foreign light sources. The situation was improved by installing a higher number of sensors and by fine-tuning the control system.

### 3.2.3 Sun shading system

The windows are equipped with an exterior automatically controlled shading system towards south, east, and west. It is a twofold blind system enabling managing of the upper part independently of the lower part. This enables control of sunlight penetration in the lower part while keeping the upper part open.

After some initial challenges of controlling the system, it now functions acceptable. Due to glare, there was a need to also install shading on the inside of the windows, even though this was not planned initially.



Figure 3.4 The exterior sun shading system. Photo: Forsvarsbygg / Hundven-Clements Photography.

### **3.3 Elevator**

The elevator is of the type OTIS Gen2 ReGen, which can return energy to a building's electrical grid for reuse under the right conditions. Electricity is generated when the elevator travels up with a light load, travels down with a heavy load, and during the elevator system deceleration. According to the manufacturer, the energy usage is reduced by up to 75% compared to non-generative drives (Otis, 2017).

## 4. Energy Supply Systems

---

### 4.1 Energy system design

A local seawater-based heat pump provides thermal energy to the building through a local district heating system. The heat pump is defined within the system border of the office building, with set values for the seasonal coefficient of performance (SCOP). It was predicted that the heat pump will deliver 90% of the heating and domestic hot water (DHW) need with a SCOP of 3. The predicted efficiency of the 10% heating and DHW need delivered by electricity is 88%. All the cooling need will be covered by the sea water pump, with a predicted SCOP of 10. The thermal energy losses in the waterborne circuits are included in the SCOP-values.

Figure 4.1 illustrates the thermal heating system at the Visund office. Heating is provided from the local district heating system through a 70 kW heat exchanger in the technical room. The heating is distributed in radiators, the floor heating system, and the ventilation system. A total of 86 radiators (Rio) are installed, under each of the windows at the three floors. Floor heating is provided in the cloak rooms and the entrance area of the 1<sup>st</sup> floor, through 20 mm PEX pipes. The heating system is controlled on the basis of thermostats in the rooms. In the initial calculation, the room air temperature for heating was set to 21°C within operating hours, but this was increased to 22.5°C after agreement with the users.

DHW is provided through a 130 kW heat exchanger (Alfa Laval) in the technical room. There is a DHW tank of 100 litres (OSO 5OR100), before a mixing valve where the temperature is regulated to 55°C. The DHW is disinfected in Apurgo facilities in the technical room to prevent legionella. DHW is also provided to dish washers and cleaning facilities, to reduce the energy use.

The cold water pipes are insulated with neoprene rubber (Armaflex), while the DHW and the heat circulation system is insulated with mineral wool (rockwool) with aluminium foil. Insulation of the DHW is dimensioned according to EN12828. Exterior pipes are also insulated, since the pipes could not be placed in frost-proof depth due to the terrain (depth is approximately 80 cm).

Cooling is also provided by the seawater-based heat pump, through a 100 kW heat exchanger in the technical room. Cooling is delivered to the building through fan coils on the 1<sup>st</sup> and 2<sup>nd</sup> floors and through the ventilation system. The cooling system is illustrated in Figure 4.2.

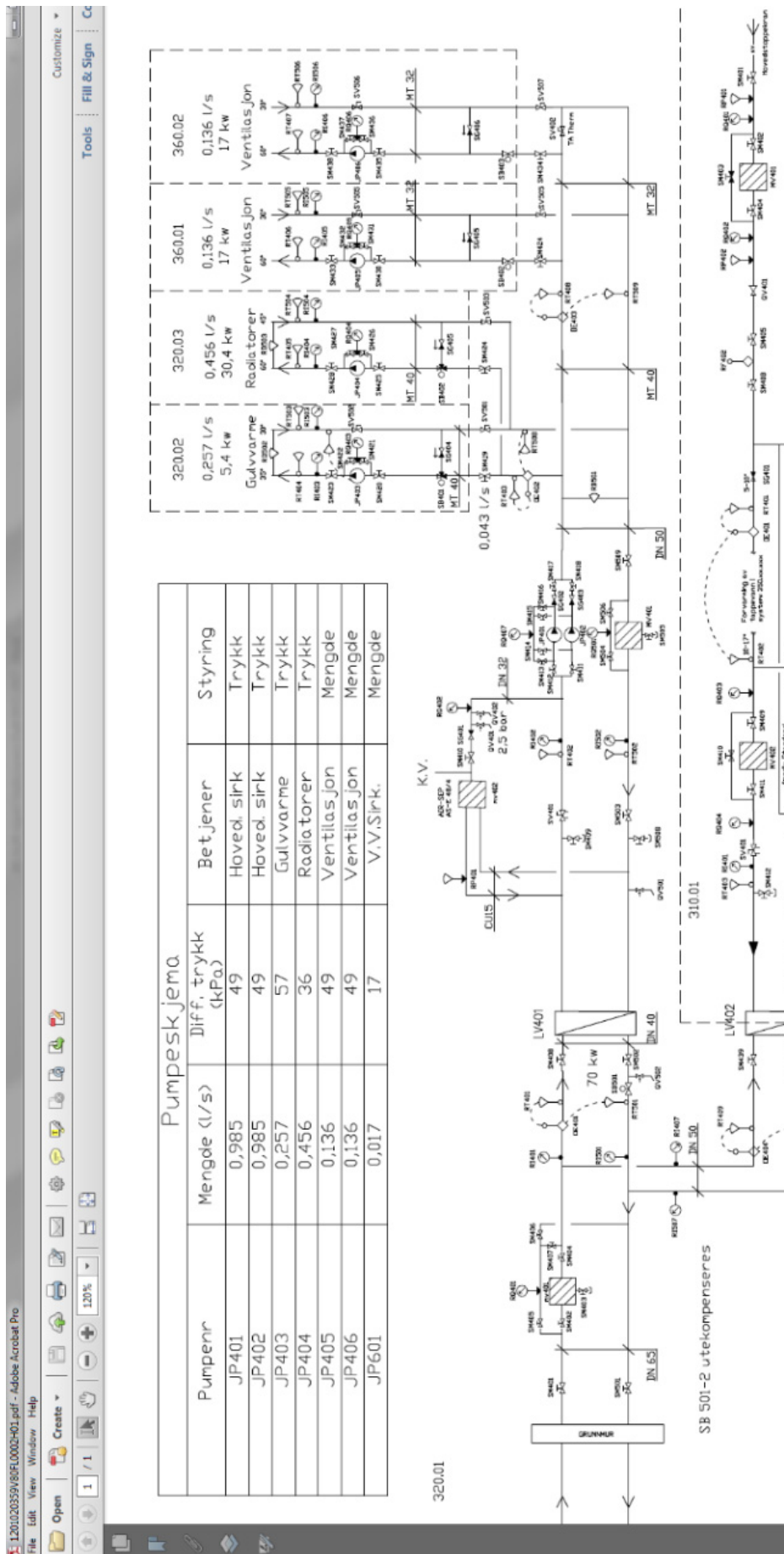

Figure 4.1 The thermal heating system at the Visund office. Illustration: Rambøll.

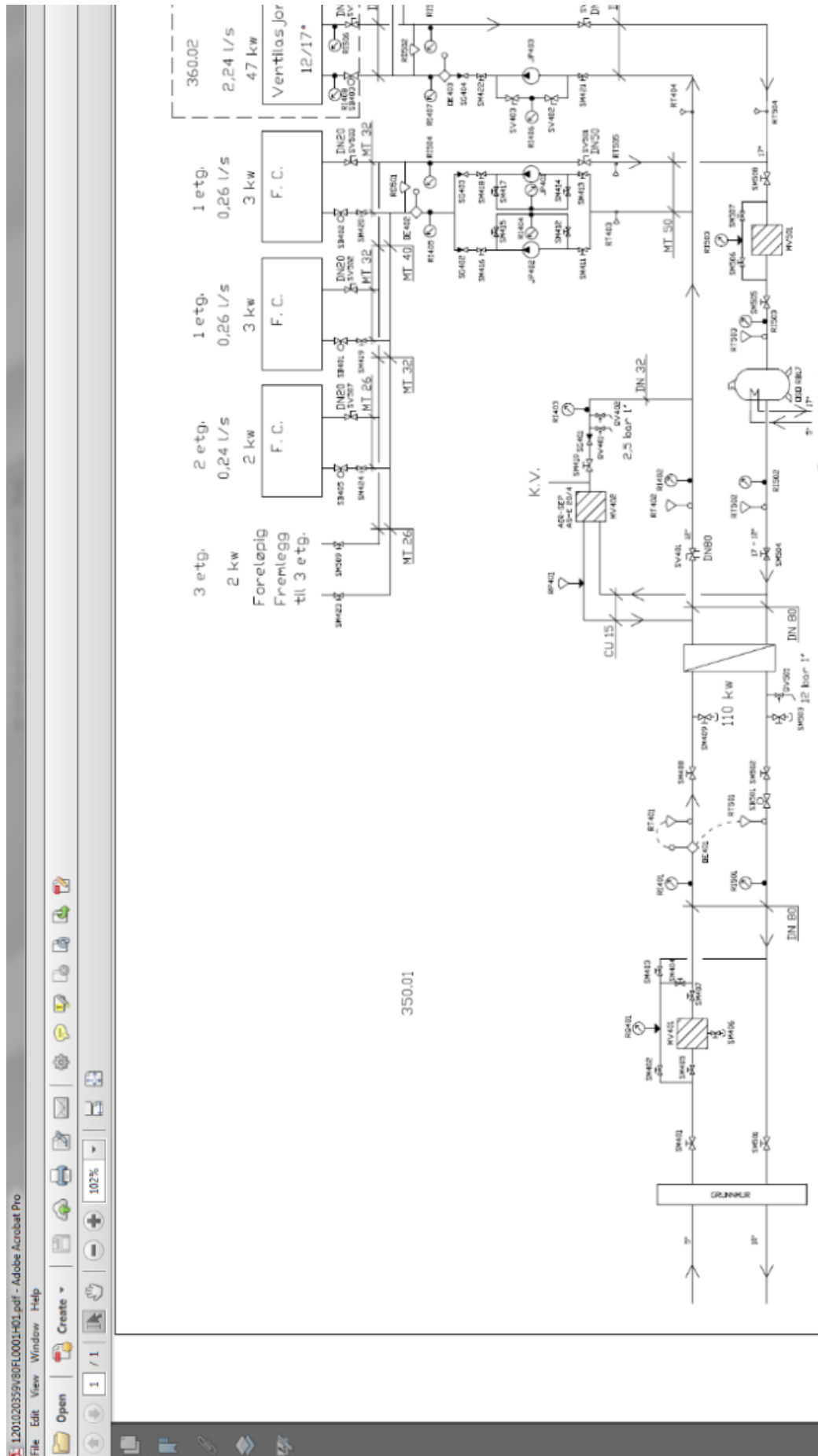

Figure 4.2 The cooling system at the Visund office. Illustration: Rambøll.

## 4.2 Energy budget

The predicted net energy need and delivered energy is shown in Table 4.1 (Forsvarsbygg, 2012), using terms from prEN 15603 (European committee for standardization, 2013) and NS3031. The total net energy need of the office building is 54.1 kWh/m<sup>2</sup> and the required delivered energy is 42.1 kWh/m<sup>2</sup> electricity. Excluding appliances of 15.7 kWh/m<sup>2</sup>, a photovoltaic (PV) system has to generate a minimum of 26.4 kWh/m<sup>2</sup> of solar electricity to satisfy the ZEB-criterion.

Predicted energy demand was calculated using the computer program SIMIEN (programbyggerne.no). The calculations were based on statistical weather data for Bergen, and according to the Norwegian standard 3031 (NS3031).

Table 4.1. Predicted yearly net energy need and delivered energy for the building, per net heated floor area. Calculations are based on statistical weather data for Bergen and according to NS3031, using the computer program SIMIEN ([www.programbyggerne.no](http://www.programbyggerne.no)).

	Net energy demand	Delivered electricity demand
Space heating	8.4 kWh/m <sup>2</sup>	3.5 kWh/m <sup>2</sup>
Ventilation heating	2.8 kWh/m <sup>2</sup>	1.1 kWh/m <sup>2</sup>
Domestic hot water	5.0 kWh/m <sup>2</sup>	2.1 kWh/m <sup>2</sup>
Fans	6.0 kWh/m <sup>2</sup>	6.0 kWh/m <sup>2</sup>
Pumps	1.0 kWh/m <sup>2</sup>	1.0 kWh/m <sup>2</sup>
Lighting	12.5 kWh/m <sup>2</sup>	12.5 kWh/m <sup>2</sup>
Appliances	15.7 kWh/m <sup>2</sup>	15.7 kWh/m <sup>2</sup>
Space cooling	2.8 kWh/m <sup>2</sup>	0.3 kWh/m <sup>2</sup>
Total	54.1 kWh/m <sup>2</sup>	42.1 kWh/m <sup>2</sup>

To satisfy the ZEB-criterion, a PV system has to generate at least 26.4 kWh/m<sup>2</sup>, or 53,000 kWh/yr. The predicted energy production from the PV-system was 55,320 kWh/yr or 27.2 kWh/m<sup>2</sup> heated floor area, providing a margin of 0.8 kWh/m<sup>2</sup>. Predicted energy production from the solar cells was calculated using the software PVSyst ([www.pvsyst.com](http://www.pvsyst.com)) and climate data from Meteonorm 7 (Multiconsult, 2014).

### 4.3 The Photovoltaic System

The photovoltaic panels were placed on the roof with a tilt angle of 10, facing east/west, as shown in Figure 4.3. The system consists of 254 panels of the type BenQ SolPower (a 333 kW<sub>p</sub>), with a total panel area of 414 m<sup>2</sup> and installed power 84.58 kW<sub>p</sub>. The inverter type is Sunny Tripower.



Figure 4.3 The installation of the PV panels on the roof. Source: Veidekke.



Figure 4.4 PV panels on the roof of Visund. Photo: Forsvarsbygg / Hundven-Clements Photography.



## 4.4 Control system

A web-based control system (LINDINSPECT) was chosen to monitor and optimize the indoor climate of the building. The interface is intuitive and specially designed for demand-controlled ventilation (Figure 4.5). It is adapted to fit on tablets and larger smartphones.



Figure 4.5 Room system with clickable floor- and room-interface that enables easy set-point adjustments and default detection.

The control system includes a wide-range of functionalities like:

- Instrument panel on the start page
- Current weather
- Overview in 4D (3D + time as a parameter)
- Plan views for easy overview - with filters and thresholds
- Node popups with values, set points, alarms, notes, etc.
- Smartphone Custom node manager
- Graphs in the form of plots, histograms, and duration charts
- Set point history
- Alarm management with dynamic alarm limits and various alarm levels, sent via e-mail
- Visualization of values from other protocols such as Modbus and KNX for example heater and solar shading

Energy meters are installed in the office building, according to the different energy uses. In total there are about 30 meters for electrical or thermal energy. The electricity meters are mainly placed in the main distribution board in the building, while the meters for thermal energy are placed in the relevant waterborne circuits. Figure 4.6 shows a screen shot of the monitoring system, showing the energy meters installed.

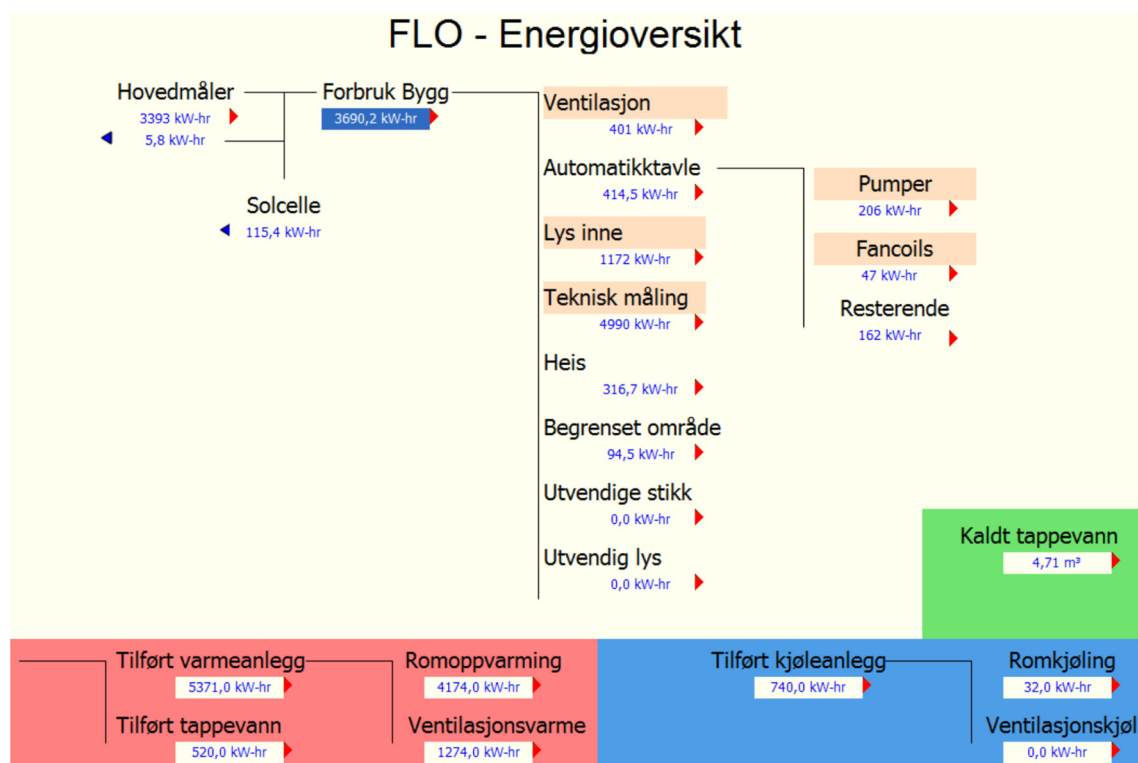

Figure 4.6 Screen shot showing the energy meters installed in the Visund office building. Illustration: Forsvarsbygg.

---

## 5. Operational Building Performance

---

Operational building performance from the first year of operation is partly described already; For ventilation in Chapter 3.1 and for the lighting and sun shading system in Chapter 3.2.

In this Chapter, Chapter 5.1 presents the energy measurements from the first year of operation. Chapter 5.2 presents information on indoor climate performance, based on interviews done by Moum et al. (2017 (to be published)-b).

### 5.1 Energy measurements

#### 5.1.1 Introduction to the energy measurements

During the two-year trial period, the contractor Veidekke needs to verify the energy goals.

This is based on collection of the following data on a monthly basis, starting from January 2016:

- Temperatures and solar radiation: Outdoor temperature (average weekly and monthly) and indoor temperatures on each floor (average weekly) from temperature sensors. The global solar radiation data is measured by a national weather station located at Flesland, about 4 km from Haakonsværn.
- Energy measurements according to the different energy uses, e.g. heating, DHW, fans, pumps, lighting, appliances, and cooling, as well as energy delivered from the electricity grid and from the local seawater-based heat pump central.
- Electricity generated by the PV-system. The measurements are based on an electricity meter, placed in the main distribution board in the building.

The energy measurements are rather complete, with few missing data. The collected data are added to an excel-based energy management system. The energy measurements for the different energy uses are summarized to get the net energy need. The delivered energy is calculated based on the net energy need, using conversion values from the energy predictions for SCOP values, system efficiencies, and distribution between electricity and waterborne heating.

The heating need is temperature corrected monthly, by calculating a correcting factor described by Dokka and Grini (2013), where the base temperature is set to 9°C. No other operational factors are currently corrected.

In the energy management system, the monthly net energy need, delivered energy, and electricity generation are compared with predicted values. Further, the deviations are highlighted, divided on the different energy uses. Energy use/outdoor temperature (ET) charts are also created, based on weekly heating/cooling/electricity consumption and average outside temperatures.

If the need for delivered energy becomes 20% higher than calculated or more, 4% of the building contract price is deducted as a compensation for increased energy costs. The purpose is to give the contractor incentives to closely follow-up energy use from start of operation like handling deviations and to close them quickly if expedient. The building owner, contractor, and ZEB-researchers had meetings to follow-up the monitored energy performance.

### 5.1.2 Energy performance

The temperature corrected net energy need according to the different energy uses is shown in Figure 5.1. The net energy need during the first year of operation corresponds well with the predictions. The total net energy need in 2016 is 57.4 kWh/m<sup>2</sup>, 6% higher than the calculated value of 54.1 kWh/m<sup>2</sup>.

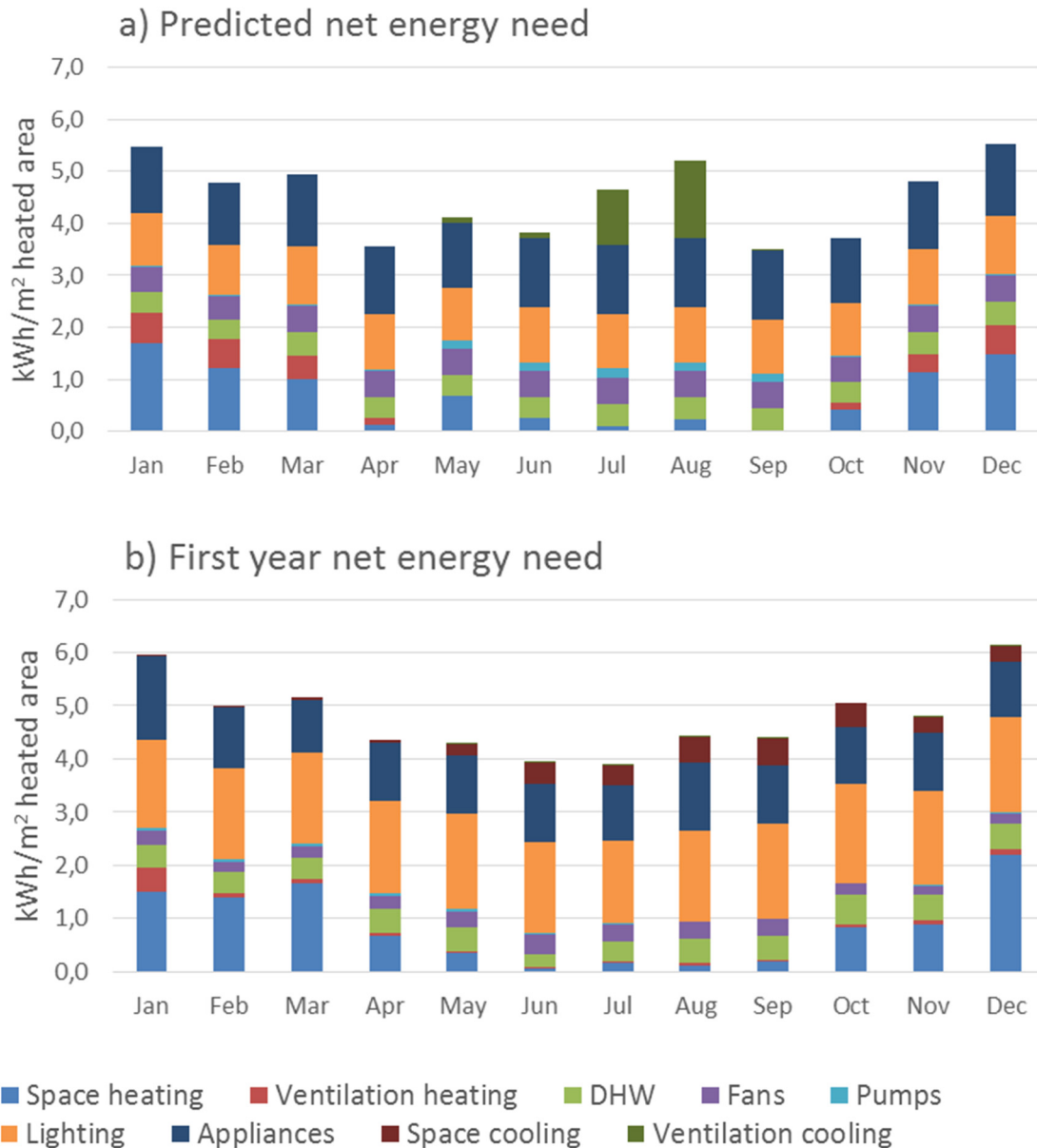

Figure 5.1 Net energy need based on a) predictions and b) first year measurements in the Visund office building, according to the different energy uses. The heating need is temperature corrected

When looking at the space and ventilation heating added together, the measurements correspond to the predicted heating need. Compared to the predictions, space heating is higher and ventilation heating is lower than calculated. Also the need for domestic hot water corresponds to the predicted need. Fans and pumps used only about half of the energy need predicted.

The energy need for lighting is 66% higher than predicted; 20.8 kWh/m<sup>2</sup> compared to calculated 12.5 kWh/m<sup>2</sup>. When appliances are excluded, energy for lighting represents a rather large share of the final energy use during the first year, 47% of the net energy need and 66% of the delivered energy.

The project group has a focus on reducing this energy use. Automatic control of lighting and sun shading screens has been a challenge during the first operational year. During the year, improvements have been done on the occupancy and daylight system. The lighting system is a combination of LEDs and T5 fluorescent tubes. According to Forsvarsbygg, the use of only LEDs could reduce the energy use for lighting to below the estimated values.

Even though the energy need for appliances is not a part of the energy goal, also this energy use is monitored closely. In 2016, the energy need was 14% lower than predicted, or 13.5 kWh/m<sup>2</sup>.

Energy for space and ventilation cooling was 3.2 kWh/m<sup>2</sup> in 2016, 15% higher than predicted.

Also the delivered energy to the building corresponds well with the calculations. In total, delivered electricity to cover the buildings energy need was 45.1 kWh/m<sup>2</sup> in 2016, 7% higher than the predicted value of 42.1 kWh/m<sup>2</sup>. The delivered energy is calculated using the conversion values from the energy predictions, as described in Chapter 4.1. If using an alternative method of summarizing the delivered electricity and thermal energy, and using the same SCOP for thermal energy, delivered electricity was 46.4 kWh/m<sup>2</sup> in 2016, 11% higher than the predicted value. This alternative result is not temperature corrected, but the temperature correction changed the initial result with less than 0.5%. The reason for the difference between the two methods is that the real efficiencies and other conversion factors varies from the predictions.

The relationships between temperatures and heating / cooling energy consumption in a building can be simplified using a linear model (Kissock et al., 1998). ET charts were used for the office building when evaluating the monitored data, showing weekly heating / cooling / electricity consumption and average outside temperatures. The ET curve for the weekly heating need in 2016 is shown in Figure 5.2. The ET chart evaluation can detect exceptional situations or faults.

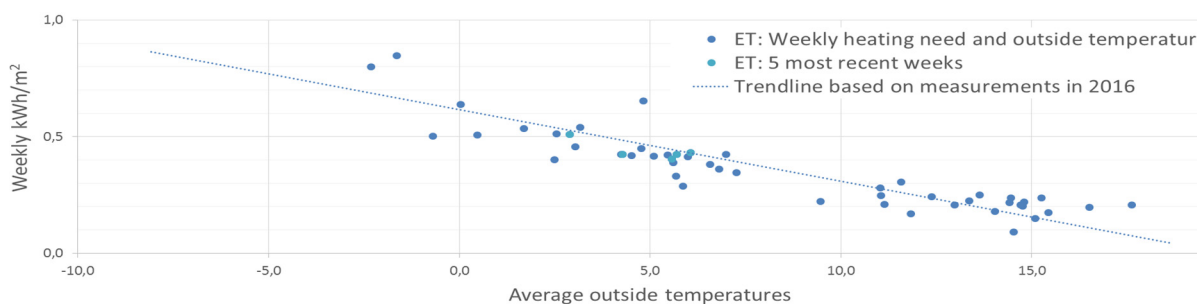

Figure 5.2 ET chart showing the relationship between weekly energy use for heating and average outside temperatures.

In general, the predictions have provided a good basis for the energy monitoring; both the calculated energy need using SIMIEN and the calculated energy production using PVsyst. Except for the heat need, which is temperature corrected, no other measurements were modified. If correcting other operational parameters or weather parameters, the results would change. For example, the average indoor temperature was 22.9°C in 2016, while the predicted temperature was 21°C (19°C) within (and outside) operating hours. If recalculating the predicted heating need and delivered energy using the indoor temperatures of 22.5°C (20.5°C), the energy need would increase with 19% to 64.2 kWh/m<sup>2</sup> and the delivered energy would increase with 10% to 46.3 kWh/m<sup>2</sup>. During the initial year 2016, both the energy need and the delivered energy were lower than these recalculated values.

The building owner and the contractor have had a high focus on energy monitoring and the subsequent need for improvements. During the two-year trial period, the contractor needs to verify the energy goals defined in the contract. If the need for delivered energy proves to be more than 20% higher than calculated, 4% of the building contract price is deducted. This gave the contractor incentives to closely follow-up energy use from the first day of operation. The follow-up required detailed monitoring with the purpose to reveal deviations caused by not optimal operation or energy related failures. The interaction between goals, contract, and monitoring is rated as a success factor for achieving the project goals for energy (Moum et al., 2017 (to be published)-a). The monitoring has provided a valuable generic knowledge on how the technology solutions actually work when the building is in use.

### 5.1.3 Produced electricity

The energy generation from the PV plant is shown in Figure 5.3, together with the solar radiation. The total electricity generation in 2016 was 55,770 kWh/year or 27.5 kWh/m<sup>2</sup>, which corresponds well to the predicted energy generation.

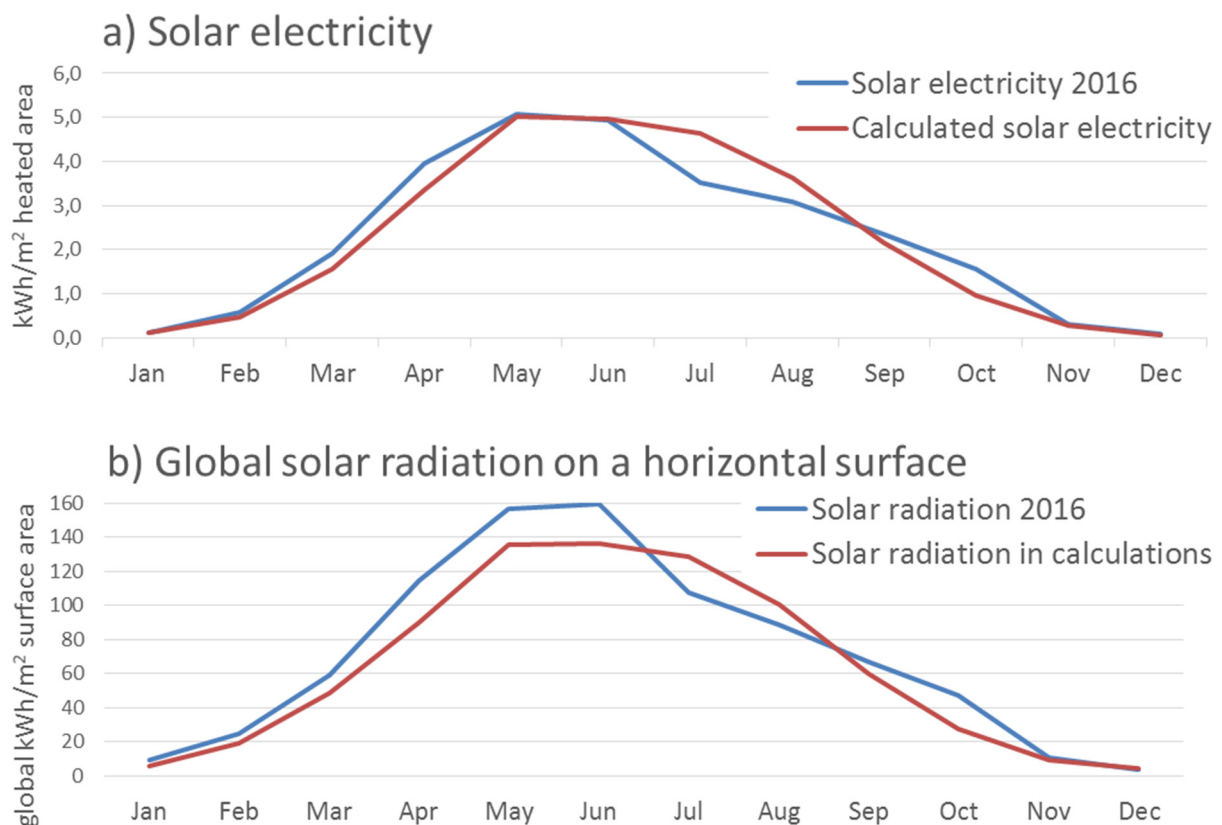

Figure 5.3 (a) Predicted and first year measurements of solar electricity; (b) Predicted and first year measurements of the solar radiation.

## 5.2 Indoor Climate Performance

(Moum et al., 2017 (to be published)-b) interviewed a user representative four to five months after hand-over.

After the hand-over, the users criticized the temperature (too cold) and the amount of dust in some of the office areas. The temperature was adjusted from the standard 21 degrees to 22.2 degrees, and

improved cleaning routines helped minimizing the dust. The outdoor solar shielding did not work properly due to reflections from a roof in the neighbourhood. Therefore, the system had to be complemented with individual indoor daylight shielding solutions. There have also been problems with the daylight-controlled lighting system, which uses more energy than estimated. A better control strategy and some individual adjustments have improved the situation. The users have criticized the noise and lack of privacy in the new, open office solutions. The installation of glass walls have helped reducing such acoustic conflicts.

All in all, after the first months of handling "childhood diseases" and simply getting used to the new building, most problems are solved and the users seem satisfied with the ZEB solutions.

## 6. The ZEB balance

The ZEB ambition level of the building design is ZEB-O+EQ, where emissions related to all energy use in operation "O" except energy use for equipment/appliances (EQ) shall be compensated with on-site renewable energy generation (Fufa et al., 2016).

To satisfy the ZEB-goal, the PV plant has to generate as much electricity as the energy delivered to the building, except the energy needed for appliances. In 2016, the energy need for appliances was 13.5 kWh/m<sup>2</sup>. The delivered energy during the year was 45.1 kWh/m<sup>2</sup>, and energy generation from the PV plant was 27.5 kWh/m<sup>2</sup>, giving a net delivered energy of 17.6 kWh/m<sup>2</sup>; 4.1 kWh/m<sup>2</sup> more than the energy need for appliances. The ZEB-goal was therefore not completely achieved during the first year of operation. Figure 6.1 shows the delivered energy monthly, when excluding appliances.

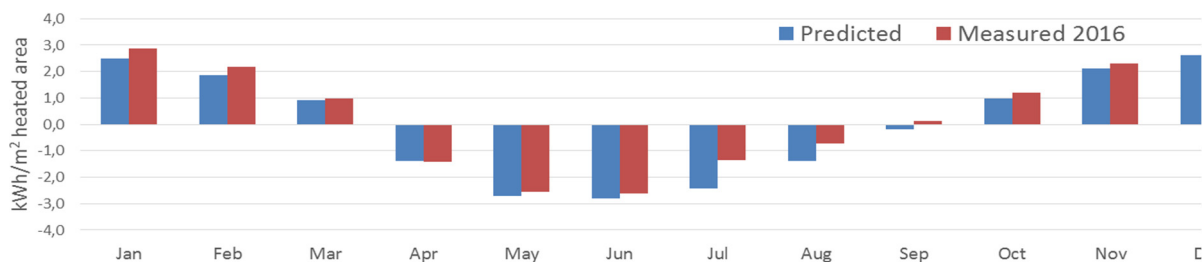

Figure 6.1 Net delivered energy during the first year of operation.

In 2016, delivered energy was 7% higher than the predicted value, achieving the contract requirement of maximum 20%. Given that this was the initial operational year, with a number of improvements, it seems possible to later achieve the ZEB-goal of net zero emission balance for building operation during a year, not including the energy for appliances. This can e.g. be achieved by reducing the energy use for lighting, or by reducing the indoor air temperature closer to design temperature. The energy for lighting was 8.3 kWh/m<sup>2</sup> than predicted in 2016, exceeding the needed reduction of 4.1 kWh/m<sup>2</sup> to achieve the goal in 2016.



## 7. Design and Construction Process

---

This as-built report gives a brief description of the design and construction process. Experiences from the building project is described in more detail in case study reports (Moum et al., 2017 (to be published)-a), (Moum et al., 2017 (to be published)-b). The reports are based on semi-structured interviews with eight informers. The interviews were done in April and May 2016, four to five months after the building was taken into use.

### 7.1 The Design Process

The target of the government is that all new buildings will be nearly zero-energy by the end of 2020. The Ministry of Defence referred to this target in their implementation assignment for Visund. The new building should be constructed as a zero energy building, to gain experiences towards the national target.

In January 2010, the project team consisting of LINK Arkitektur (architects) and Multiconsult (engineers), started the design of the new office building with 97 work places at the Haakonsvern naval base. Before the design started, a kick-off workshop was arranged to define the specific goals for the project: "The building should be calculated to be zero energy with respect to heating, hot water, ventilation, fans and pumps, lighting, and cooling according to Norwegian Standard 3031 (NS 3031). Appliance energy was excluded, but should also be documented and calculated". The definition of the zero emission building was proposed and explained by representatives from the ZEB Centre.

Forsvarsbygg and the hired consultants, (Multiconsult and LINK Arkitektur) prepared the bidding documents. The design of the zero energy building was carried out in cooperation with the ZEB Centre. A functional performance requirement to reach the zero energy ambition was included in the bidding documents (Forsvarsbygg, 2012).

No special challenges were identified in the design phase.

### 7.2 The Construction Process

Veidekke AS won the regular bidding process, as the main contractor. They involved the following subcontractors:

Consultants: Rambøll (Technical disciplines)

Contractors: GK AS (ventilation), Bravida (electricity), Solenergi FUSen AS (PV-systems)

The detailed planning finished in December 2014. Veidekke started with the building pit in August 2014. The building structure was ready January 2015 and the building envelope was sealed March 2015. The take-over proceeding were completed in December 2015. The test period will last until June 2017.

The Building process was completed in accordance with the initial plans and milestones. No special challenges were identified in the construction process. The following small changes were implemented during the construction phase:

- Façade-based ventilation zones were removed. Shorter ventilation ducts were prioritized.
- Heat pipes with "turned return" were removed. ("Turned return" means pipe solutions that lead to similar pipe length and corresponding similar pressure drop to each radiator).

- The air separations from heating- and cooling-systems were simplified. Air separation is solved by the AIR\_SEP vacuum separator.
- Blinds are not controlled by room temperature or persons.
- Individual room temperature control of  $\pm 3^{\circ}\text{C}$ . (Room temperature is controlled by the active terminal device. The set-point can be changed through the BMS.)

After the first year of operation, the Visund office building appears like a success story. The case study report (Moum et al., 2017 (to be published)-a) describes a number of factors contributing to this result. Clear communication of the energy ambitions is one of these factors. The building contract and its economic consequences commits the contractor to follow up the energy performance for a 2-year period. Lastly, a positive project culture, good cooperation, and personal commitment towards the environment and the energy targets are factors which have contributed to the project achievements.

Figure 7.1 to Figure 7.3 show pictures from the building process.



Figure 7.1 The building site February 2015. Photo: Forsvarsbygg.



Figure 7.2 Thermal insulation on external walls. Photo: Forsvarsbygg.



Figure 7.3 Building of air tight walls. Photo: Forsvarsbygg.

## 8. Design and Construction Costs

---

The total cost for the 2031 m<sup>2</sup> office building is just below 108 million Norwegian kroner, or about 53 000 kr/m<sup>2</sup> heated floor area. The added costs for building a ZEB and a pilot is estimated to about 5.5 million Norwegian kroner or 2 700 kr/m<sup>2</sup>. This included the solar cell system, with a cost of about 2 million kroner.

Since this is a pilot building, the costs are higher than the costs will be if building a similar ZEB-O÷EQ building later. This is due to the additional and rather comprehensive monitoring of the energy use.

Enova supported the project with 2.5 million kroner, or 1230 kr/m<sup>2</sup>, based on the good totality of building solutions.

## 9. Summary and Conclusions

---

The Visund office building is a pilot project within the Research Centre on Zero Emission Buildings (ZEB) in Norway. The building has 2031 m<sup>2</sup> of heated floor area and is located at Haakonsværn, about 15 km from the centre of Bergen, Norway. The building is owned by the Norwegian Defence Estates Agency (Forsvarsbygg) and the main contractor was Veidekke. The building has been in operation since January 2016.

The design aimed at meeting the ZEB-criterion of net zero emission balance, excluding energy for appliances. The compact and simple building form has been carefully planned, giving an energy efficient and airtight building envelope with good daylight conditions. Heating and cooling is provided by a local seawater-based heat pump. The temperature, as well as the ventilation and lighting systems are demand controlled. A photovoltaic system installed on the roof is generating electricity.

The energy performance has been closely monitored, and the energy measurements during the first year corresponds well with the predicted energy use and required indoor climate performance. Energy need for lighting is an exception and was higher than predicted in 2016. Improvements have been done during the year to reduce this energy use. The indoor temperature has been higher than estimated in the calculations, with an average of 22.9°C in 2016, compared with estimated 21°C. The energy generation from the PV plant corresponds well to the predicted energy generation.

To satisfy the ZEB-goal, the PV plant has to generate as much electricity as the energy delivered to the building, except the energy needed for appliances. In 2016, the delivered energy during the year was 45.1 kWh/m<sup>2</sup>, and energy generation from the PV plant was 27.5 kWh/m<sup>2</sup>, giving a net delivered energy of 17.6 kWh/m<sup>2</sup>; 4.1 kWh/m<sup>2</sup> more than the energy need for appliances during the same year. The ZEB-goal was therefore not completely achieved during the first year of operation. Delivered energy was 7% higher than the predicted value, achieving the contract requirement of maximum 20%.

Given that this was the initial operational year, with a number of improvements, it seems likely that the Visund office building will later achieve the ZEB-goal of net zero emission balance for building operation during a year.

The Visund office building project shows that it is possible to build a net zero emission office building in Bergen, with commercially available products and traditional design and construction process. A high focus on clear and shared goals, contract based economic incentives, robust building design and technology choices, energy monitoring and follow-up measures have been key factors to achieve the goals.

## 10. References

---

- Andresen, I., Haanshuus, F. T., Hoel, J., Jonassen, I., Nilsen, N. I., Mysen, M., Nytræ, S. and Time, B. (2012) 'Design of a Zero Energy Office Building at Haakonsvern, Bergen', *Paper Passivhus Norden 2012*.
- Dokka, T. H. and Grini, C. (2013) 'Etterprøving av bygningers energibruk', *SINTEF fag 6*.
- European committee for standardization (2013) 'prEN 15603, Energy performance of buildings - Overarching standard EPBD'.
- Forsvarsbygg (2012) 'Haakonsvern procurement description: Funksjonsbeskrivelse Del III-E2.01 Nullenergikrav'.
- Fufa, S. M., Schlanbusch, R. D., Sørnes, K., Inman, M. and Andresen, I. (2016) 'A Norwegian ZEB Definition Guideline', *ZEB Project Report 29*.
- Grimnes, K. H. (2015) 'Termografiinspeksjon Bygg Haakonsvern'.
- Kissock, J. K., Reddy, T. A. and Claridge, D. E. (1998) 'Ambient-Temperature Regression Analysis for Estimating Retrofit Savings in Commercial Buildings', *ASME Journal of Solar Energy Engineering, Vol. 120(3): 168- 176*.
- Maripuu, M. (2009) 'Demand Controlled Ventilation (DCV) Systems in Commercial Buildings Functional Requirements on Systems and Components', *Thesis For The Degree Of Doctor Of Philosophy, Building Services Engineering Department of Energy and Environment Chalmers University of Technology Göteborg, Sweden*.
- Moum, A., Hauge, Å. L. and Thomsen, J. (2017) 'Casebeskrivelser av fire norske ZEB pilotbygg - byggeprosess og brukerevaluering'. *ZEB Project Report 31-2017*.
- Moum, A., Hauge, Å. L. and Thomsen, J. (2017) 'Four Norwegian Zero Emission Pilot Buildings – Building Process and User Evaluation', *ZEB Project Report 30-2017*.
- Multiconsult (2014) 'Notat: Design og simulering solcelleanlegg Haakonsvern'.
- Otis (2017) *Fact sheet: Otis Regenerative Drives*. Available at:  
[http://www.otis.com/site/eg/OT\\_DL\\_Documents/OT\\_DL\\_DownloadCenter/ReGen@%20-%20Product%20Information/Regen\\_FactSheet.pdf](http://www.otis.com/site/eg/OT_DL_Documents/OT_DL_DownloadCenter/ReGen@%20-%20Product%20Information/Regen_FactSheet.pdf).

## The Research Centre on Zero emission Buildings (ZEB)

The main objective of ZEB is to develop competitive products and solutions for existing and new buildings that will lead to market penetration of buildings that have zero emissions of greenhouse gases related to their production, operation and demolition. The Centre will encompass both residential and commercial buildings, as well as public buildings.



### Partners

#### NTNU

[www.ntnu.no](http://www.ntnu.no)

#### SINTEF

[www.sintef.no](http://www.sintef.no)

#### Skanska

[www.skanska.no](http://www.skanska.no)

#### Weber

[www.weber-norge.no](http://www.weber-norge.no)

#### Isola

[www.isola.no](http://www.isola.no)

#### Glava

[www.glava.no](http://www.glava.no)

#### Protan

[www.protan.no](http://www.protan.no)

#### Caverion Norge

[www.caverion.no](http://www.caverion.no)

#### ByBo

[www.bybo.no](http://www.bybo.no)

#### Multiconsult

[www.multiconsult.no](http://www.multiconsult.no)

#### Brødrene Dahl

[www.dahl.no](http://www.dahl.no)

#### Snøhetta

[www.snoarc.no](http://www.snoarc.no)

#### Forsvarsbygg

[www.forsvarsbygg.no](http://www.forsvarsbygg.no)

#### Statsbygg

[www.statsbygg.no](http://www.statsbygg.no)

#### Husbanken

[www.husbanken.no](http://www.husbanken.no)

#### Byggenæringens Landsforening

[www.bnl.no](http://www.bnl.no)

#### Direktoratet for byggkvalitet

[www.dibk.no](http://www.dibk.no)

#### DuPont

[www.dupont.com](http://www.dupont.com)

#### NorDan AS

[www.nordan.no](http://www.nordan.no)

#### Enova

[www.enova.no](http://www.enova.no)

#### SAPA Building system

[www.sapagroup.com](http://www.sapagroup.com)

#### Sør-Trøndelag fylkeskommune

[www.stfk.no](http://www.stfk.no)

#### Entrå Eiendom AS

[www.entra.no](http://www.entra.no)