

Energy efficient distillation

Ivar J. Halvorsen, Maryam Ghadrhan,
Deeptanshu Dwivedi, Mohammad Shamsuzzoha and
Sigurd Skogestad

**1st Trondheim Gas Technology
Conference,
21 - 22 October 2009**

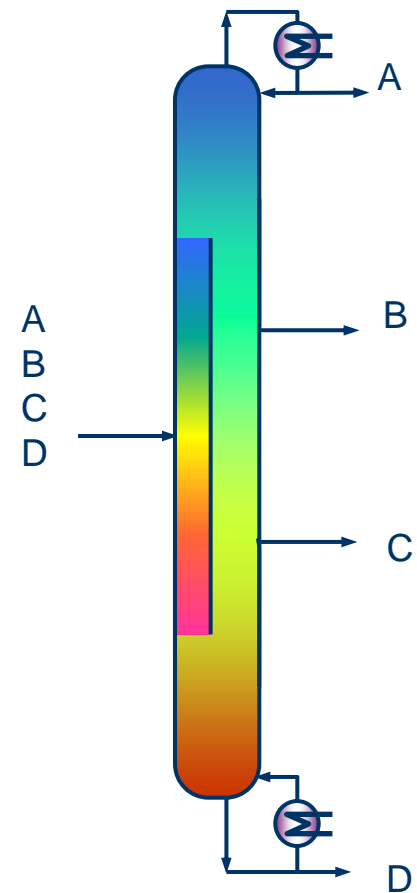

Distillation in the gas value chain

- Distillation plays an important role in splitting raw production streams into more useful product streams with specified compositions

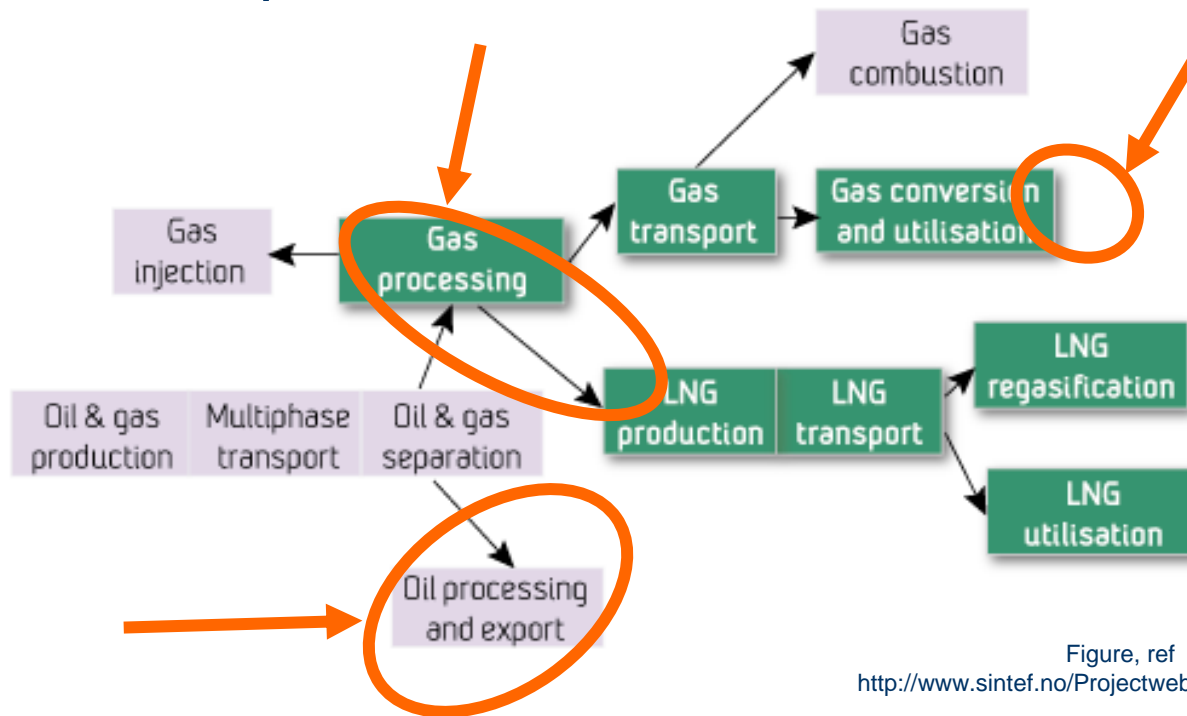

Figure, ref
http://www.sintef.no/Projectweb/Trondheim_GTS/

Distillation consumes energy

- 2-5% of the world industry heat consumption
- There is a potential for more energy efficient solutions
- Picture: Fractionation columns at the Snøhvit LNG-plant in Hammerfest

Foto: I.Halvorsen 21.09.2005



BEEDIST (Basic Energy Efficient Distillation Technology)

- Founded by the Norwegian Research Council through the GASSMAKS program
- SINTEF/NTNU 2008-2012
- Objectives
 - Study new integrated distillation arrangements
 - For reduction of capital cost and energy consumption (+ CO₂-emission related to the energy).
 - 20-40% savings in reach.
 - Evaluate application in natural gas processing and conversion.
 - Design and operation
 - Develop laboratory
 - 2 PhD + post doc

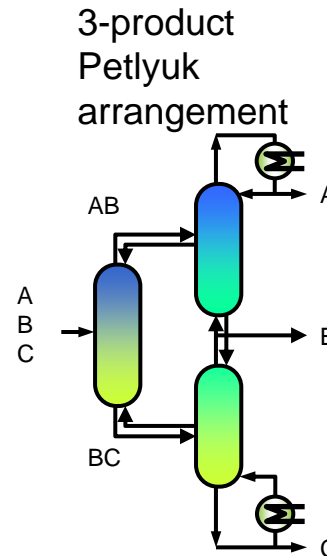

4-product Kaibel-column with a dividing wall

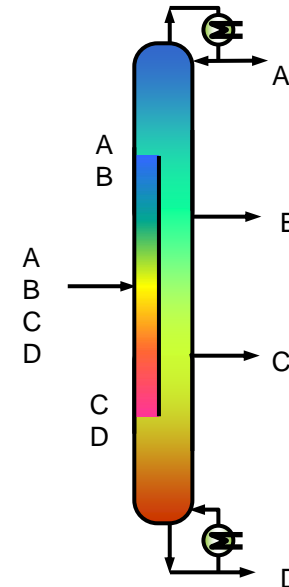

NTNU
lab



Theoretical minimum energy

An ideal reversible process requires:

$$Q_{\min} = \frac{-\Delta S T_C}{1 - \frac{T_C}{T_H}}$$

Where entropy of mixing is

$$\Delta S = -\sum_i R x_i \ln(x_i)$$

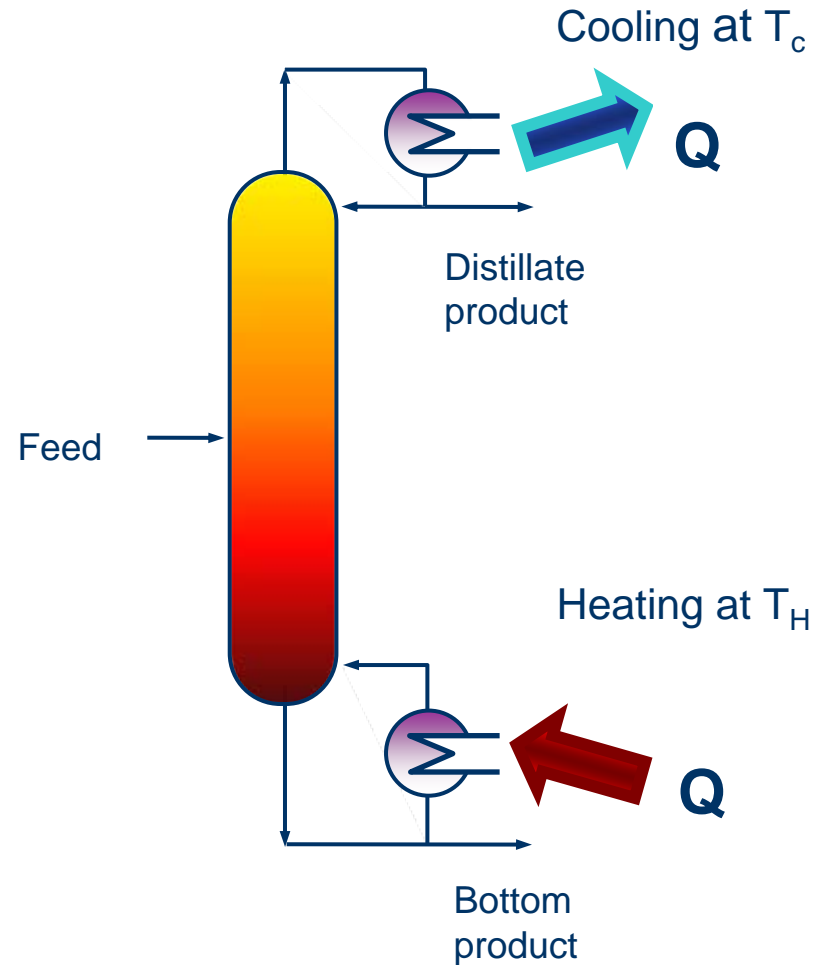

Increasing purity require energy- Mixing gives irreversible loss

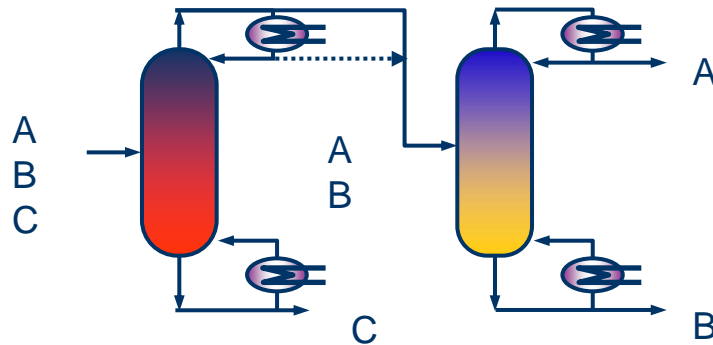

A-composition

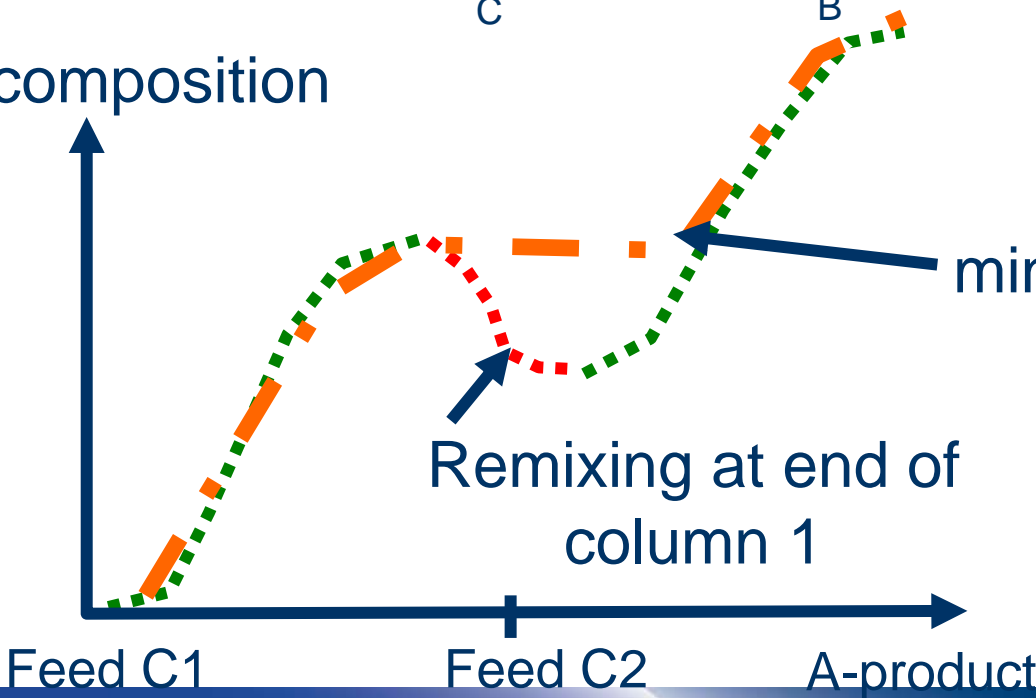

Can we find a
minimum energy route
to pure A?

Position along path
from feed to A outlet

Minimum energy path to the mountain top

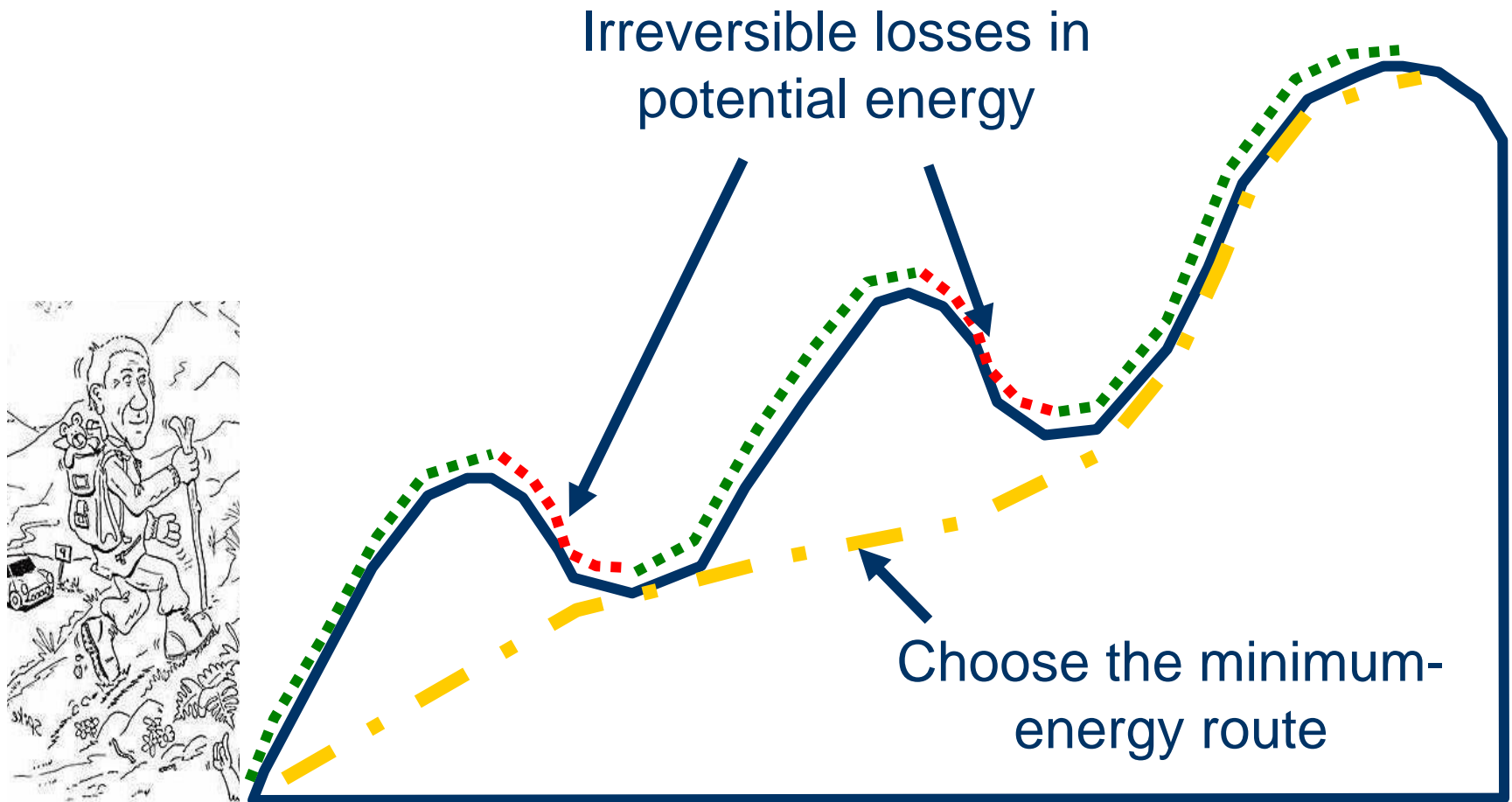

Conventional alternatives for 3-product separation: Sequence of binary columns

Direct Split: DS

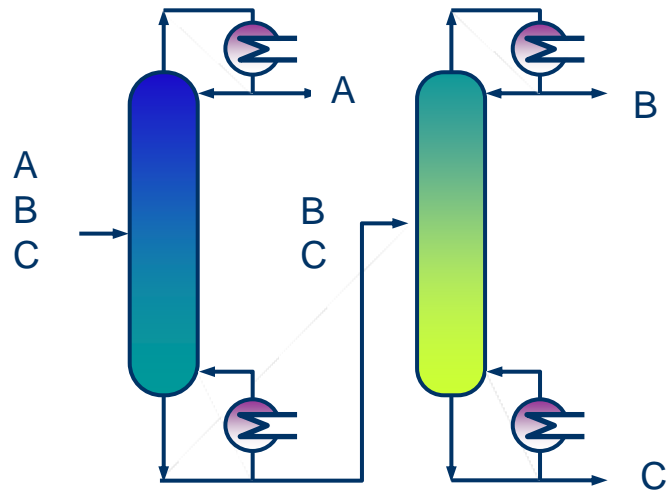

Indirect split: IS

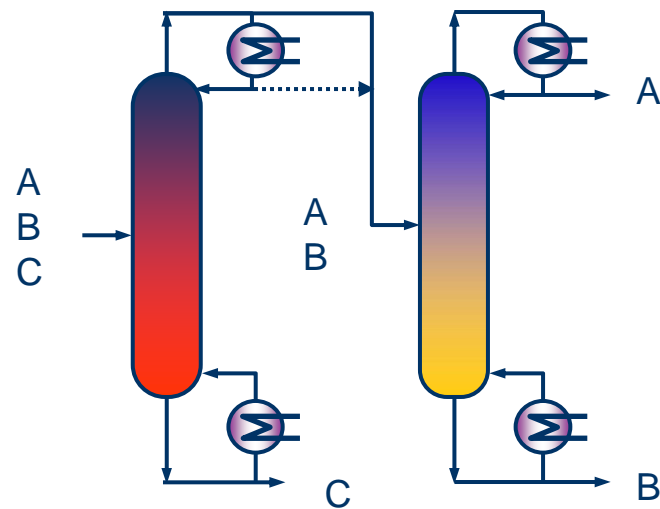

Alternatives for 3-product separation...

Prefractionator arrangement

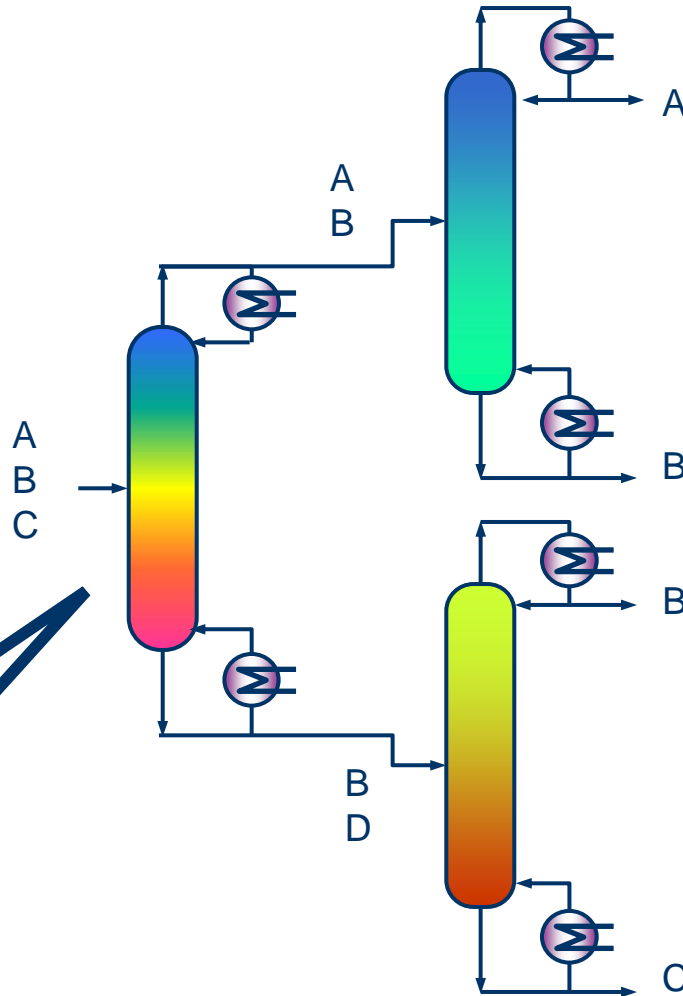

The prefractionator does the simple A/C split

Conventional Prefractionator arrangement with a single main column

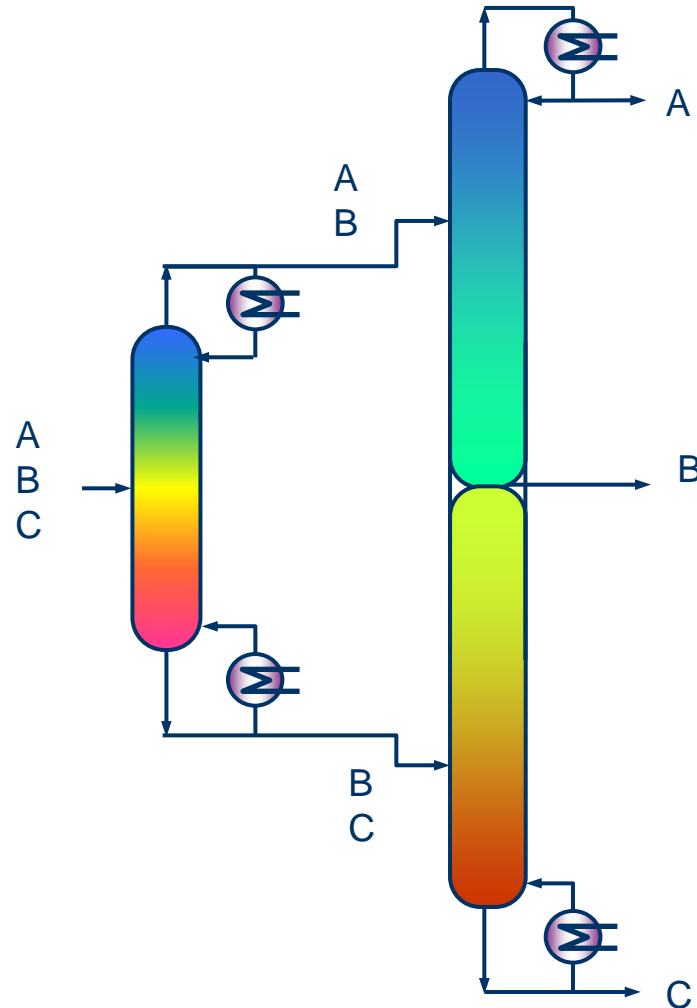

Apply full thermal coupling

The Petlyuk column removes mixing loss at the interconnections

Saves 20-30% energy

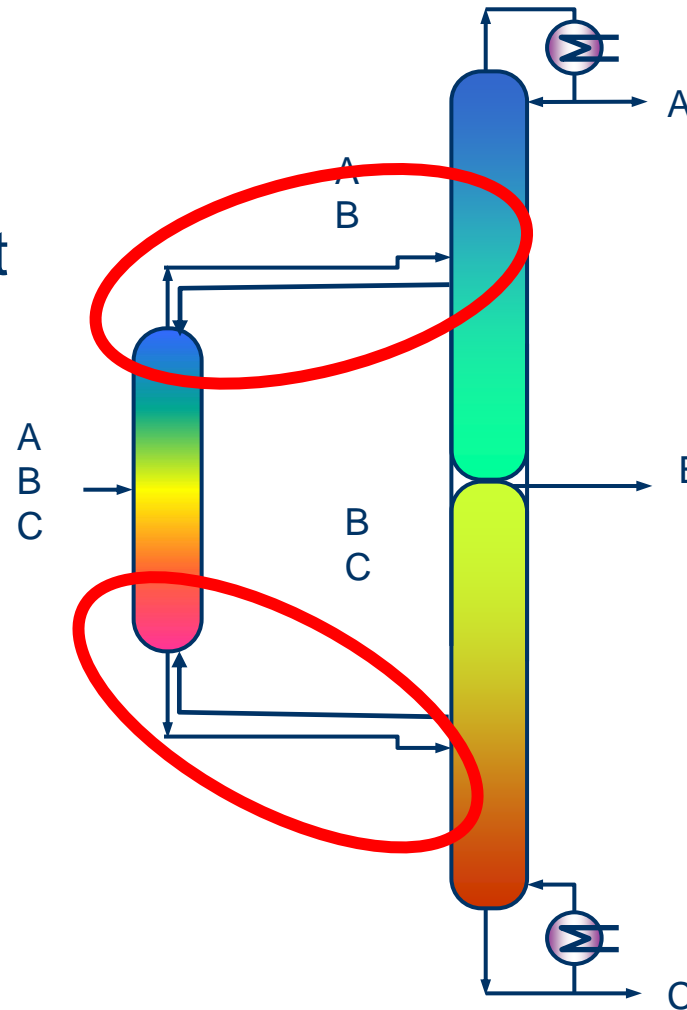

The Petlyuk path

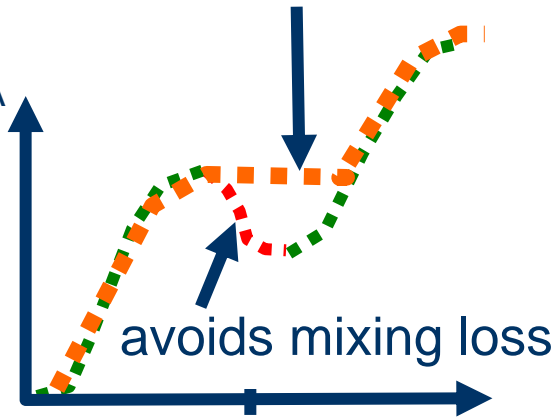

The dividing wall column (DWC)

- The Petlyuk arrangement in a single shell
- Separates a single feed into three separate products in one column
- Just a single reboiler and condenser
- Saves 20-30% in both energy and capital

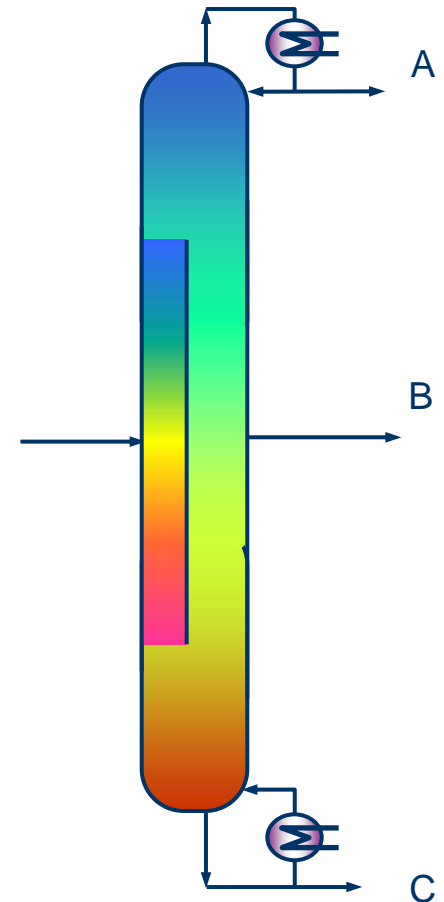

The V_{min} -diagram – for simple energy assessment

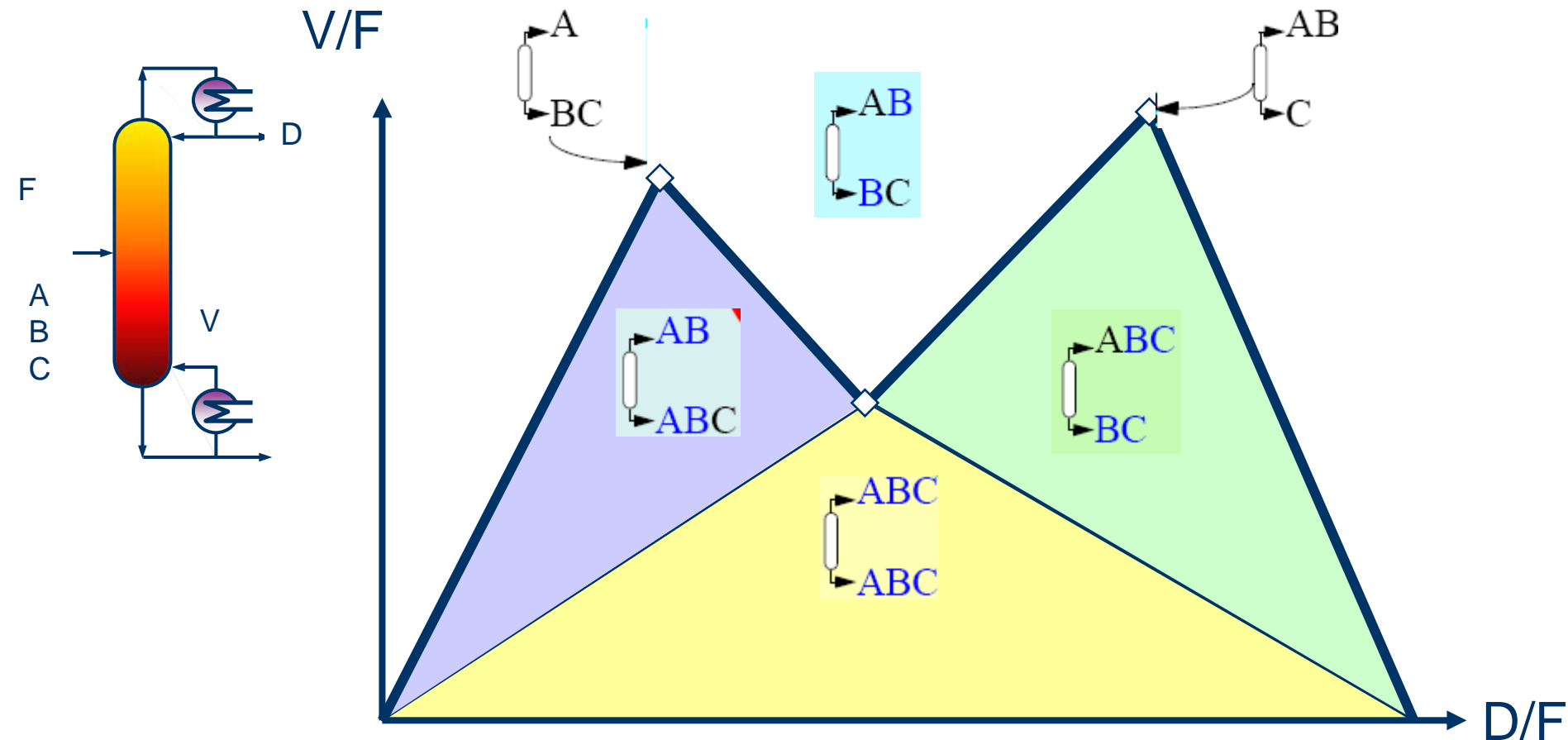

V_{min} for the Petlyuk column:
The highest peak:

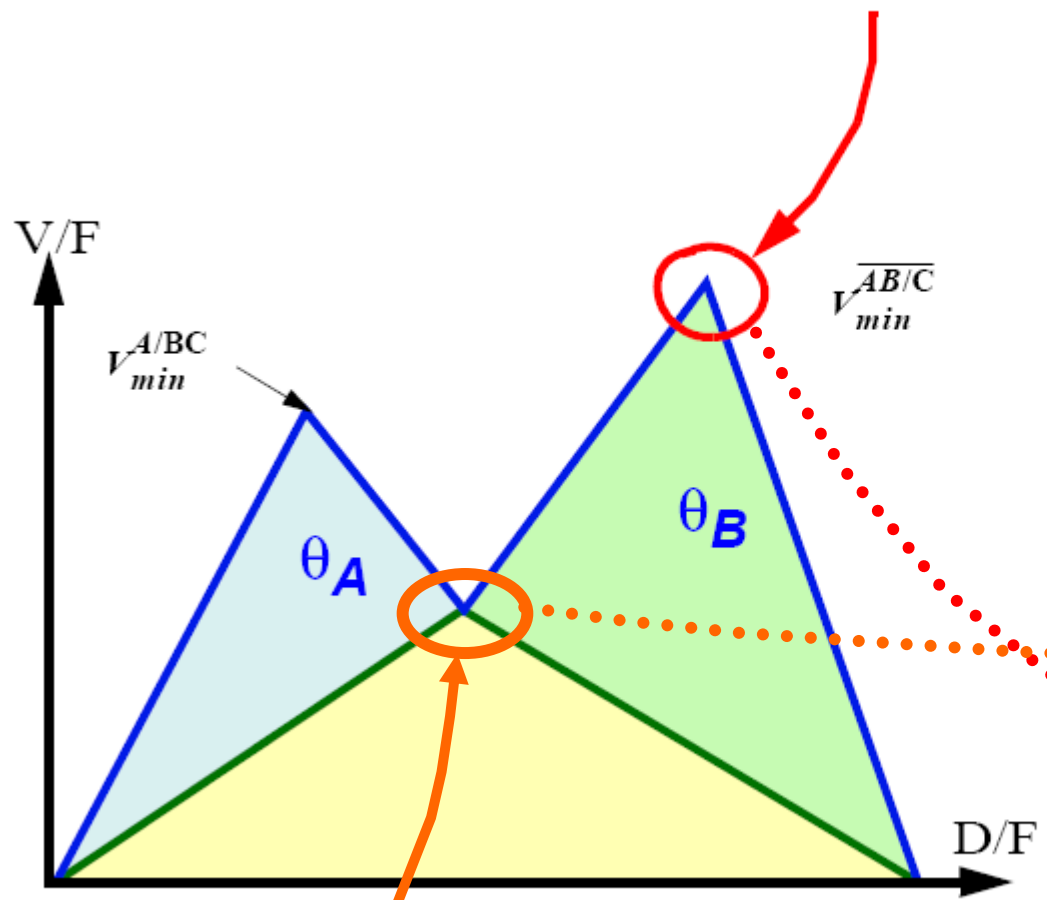

V for the prefractionator from the preferred A/C-split

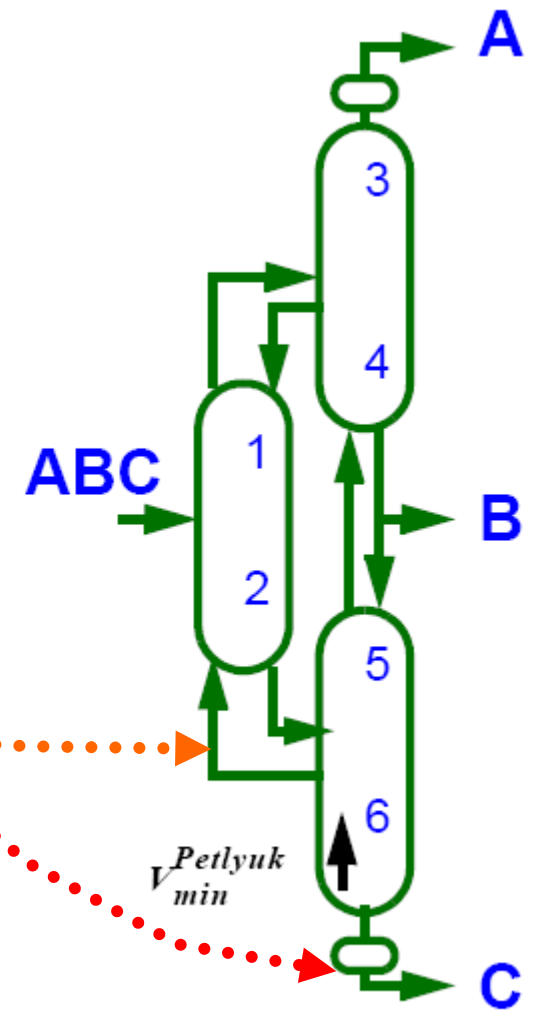

Petlyuk column: V_{\min} = the most difficult binary split

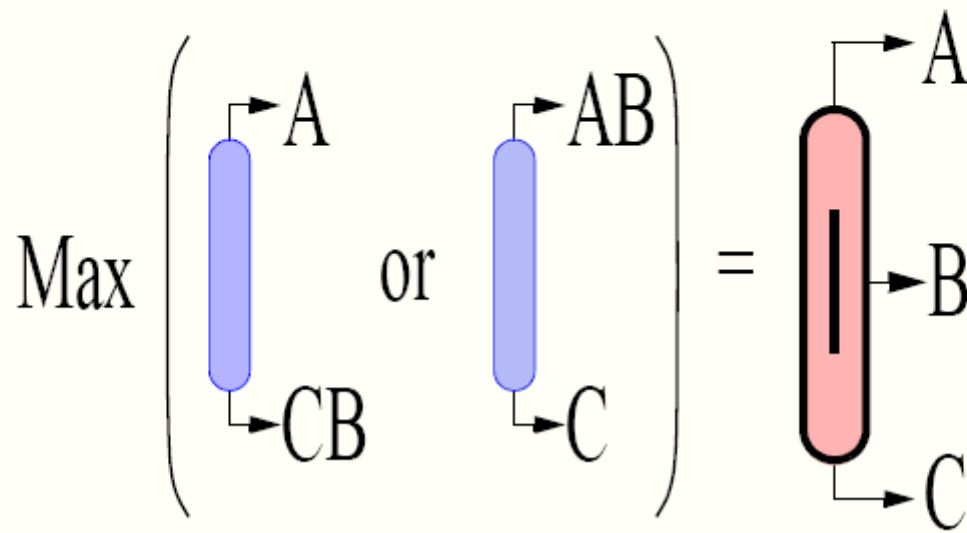

Industrial DWC/Petlyuk applications

German-speaking community dominates

- BASF: > 70 DWCs in operation. Increasing. **G. Kaibel pioner**
- Monz – main vendor for BASF
- Krupp-Uhde
- Sulzer
- Rashig
- Linde

Others

- MW Kellogg (UK)
- UOP (USA)
- UK, Japan, Indonesia, South Africa

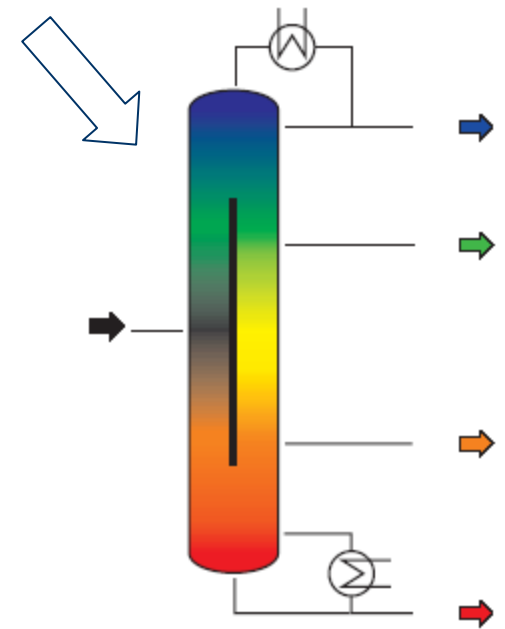

The Kaibel-column
4-product DWC!

Why consider a Petlyuk arrangement

- Large potential energy savings compared to conventional columns (20-30%)
 - Or – increase production and/or purity for given energy supply
- Capital cost savings due to more compact equipment => smaller footprint and removal of reboiler/condenser units
- Usage:
 - In theory: Anywhere (almost) where distillation is a suitable separation technology and more than 2 products are produced.
 - In practice: Some cases may be unsuitable due to required temperature/pressure range, height, or if liquid/vapor load in different sections are very different.
 - Practical variations can be made, e.g. side-strippers/rectifiers
 - Revamping of existing conventional columns may have significant potential

Critical for obtaining the teoretical savings in practice: How to control the splits

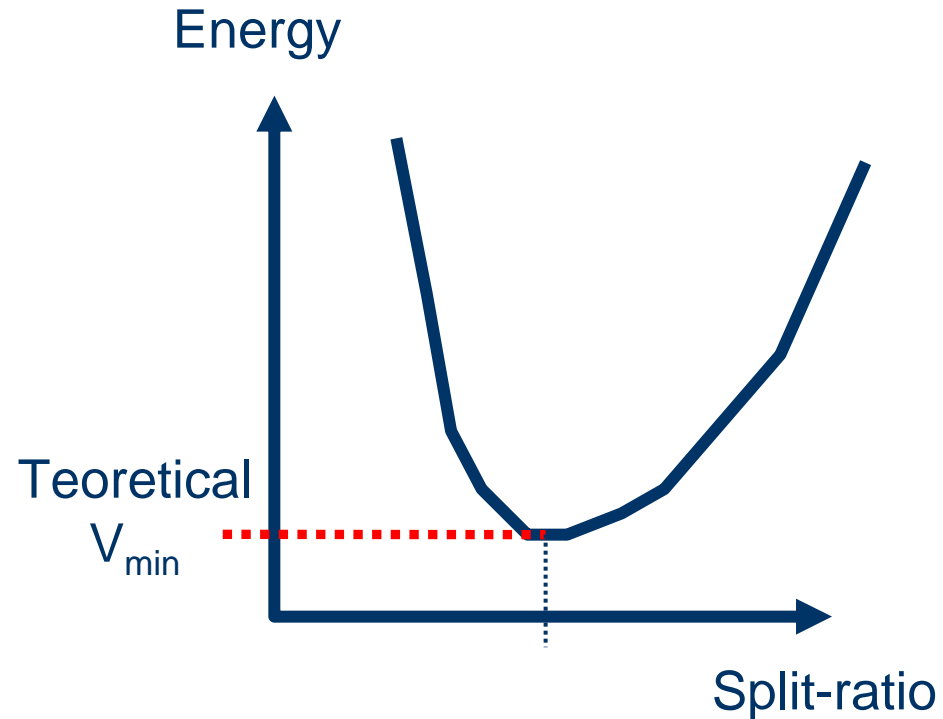
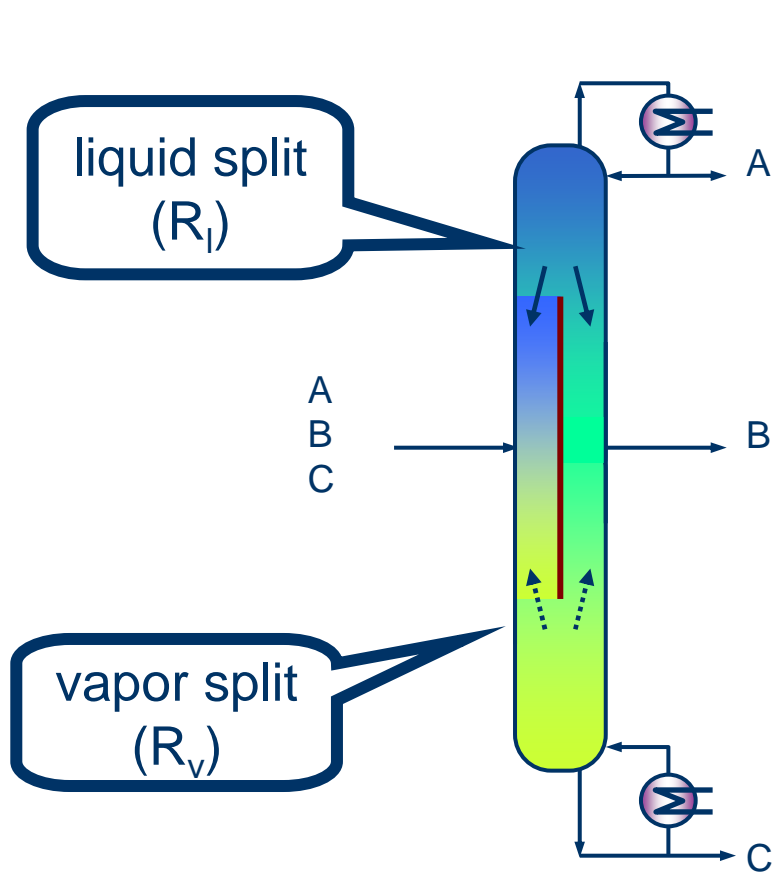

Tool: Self optimizing control

Extend to 4-product DWC: The Kaibel column – (1987)

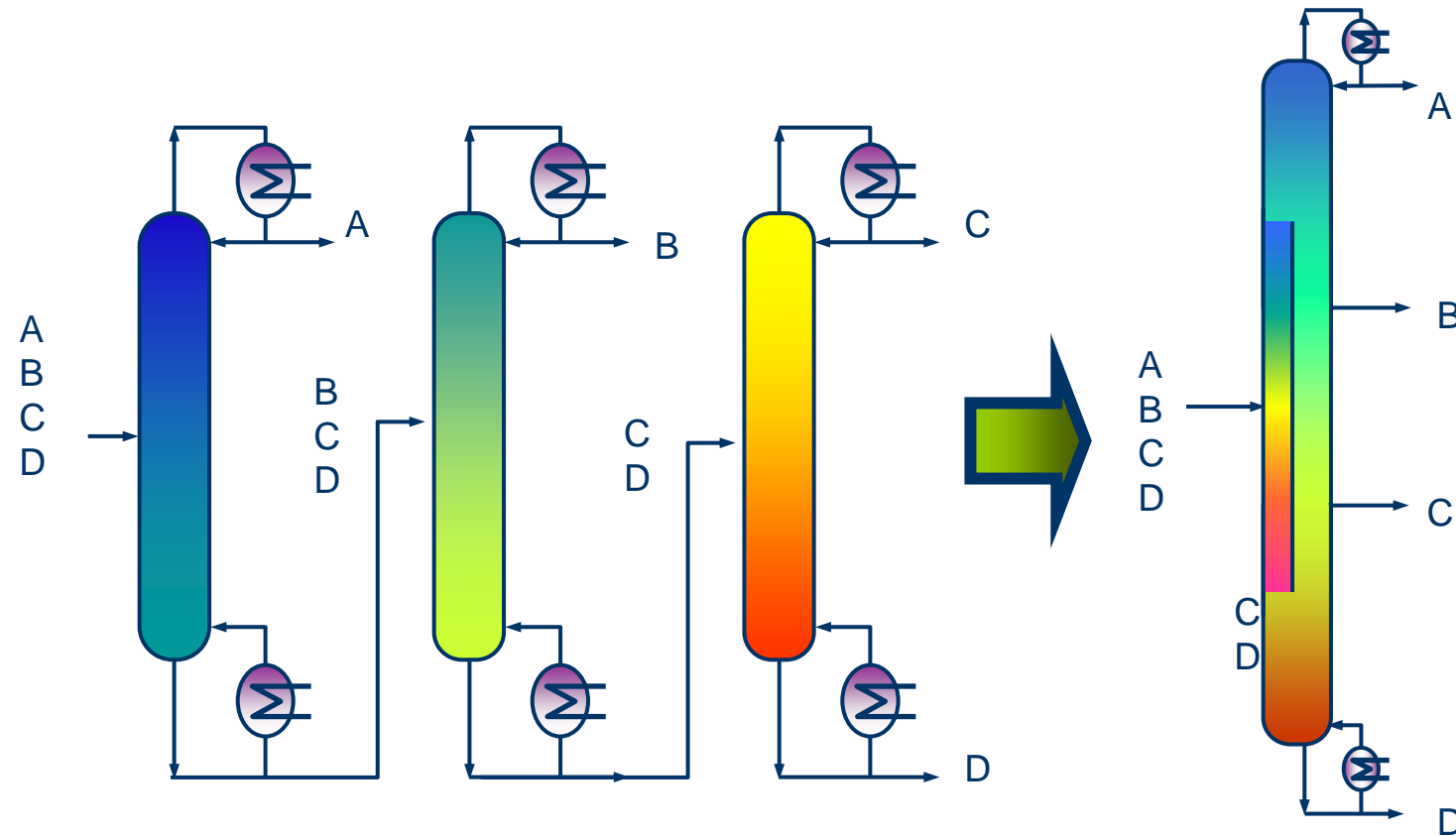

**4 products
in a single
shell!**

Saves 30-40 %

The Kaibel column at NTNU

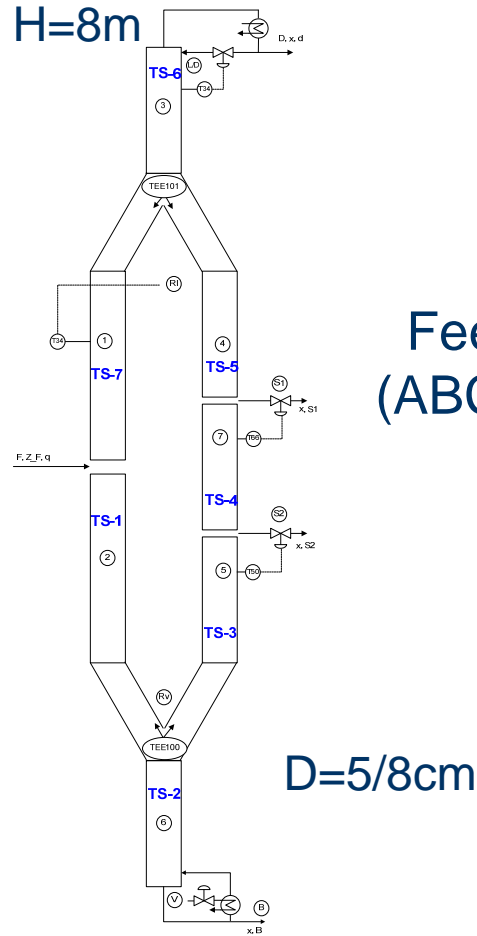
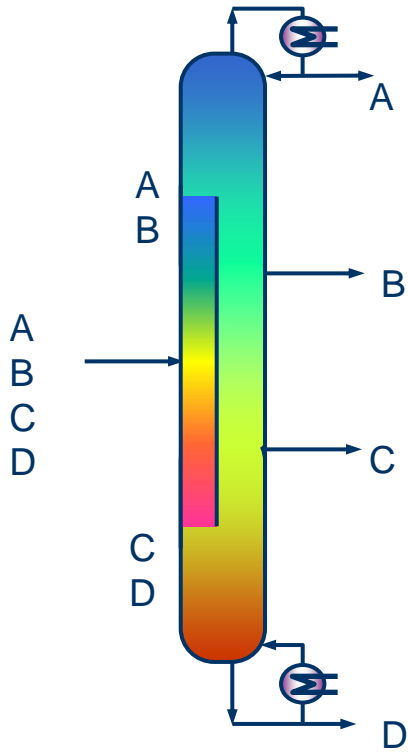

Feed
(ABCD)

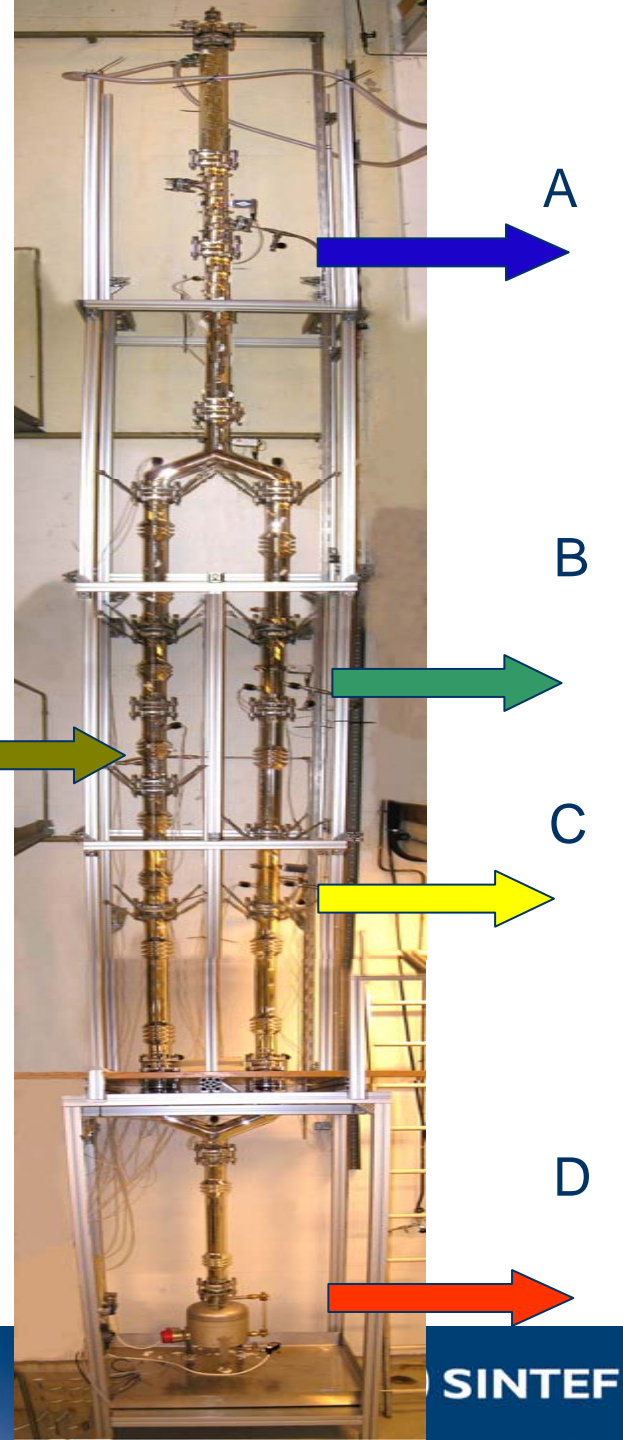

First really big 4-product DWC

Kaibel column

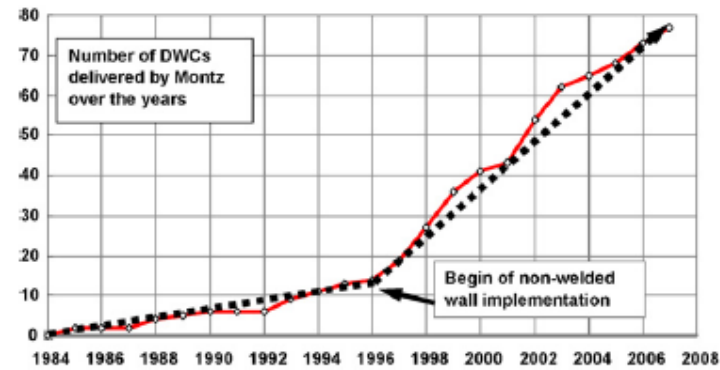

Fig. 2. The number of the dividing wall columns delivered by J. Montz over the years.

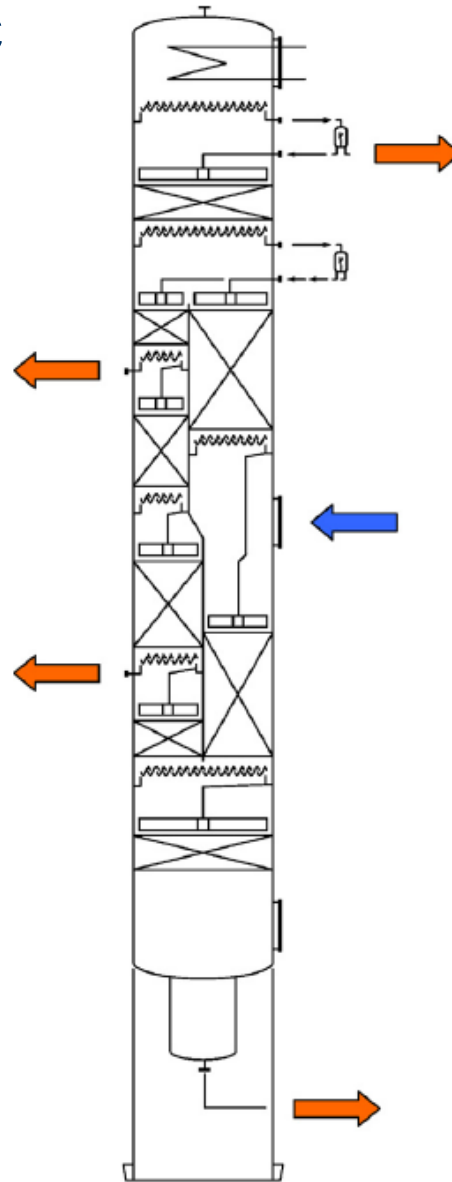
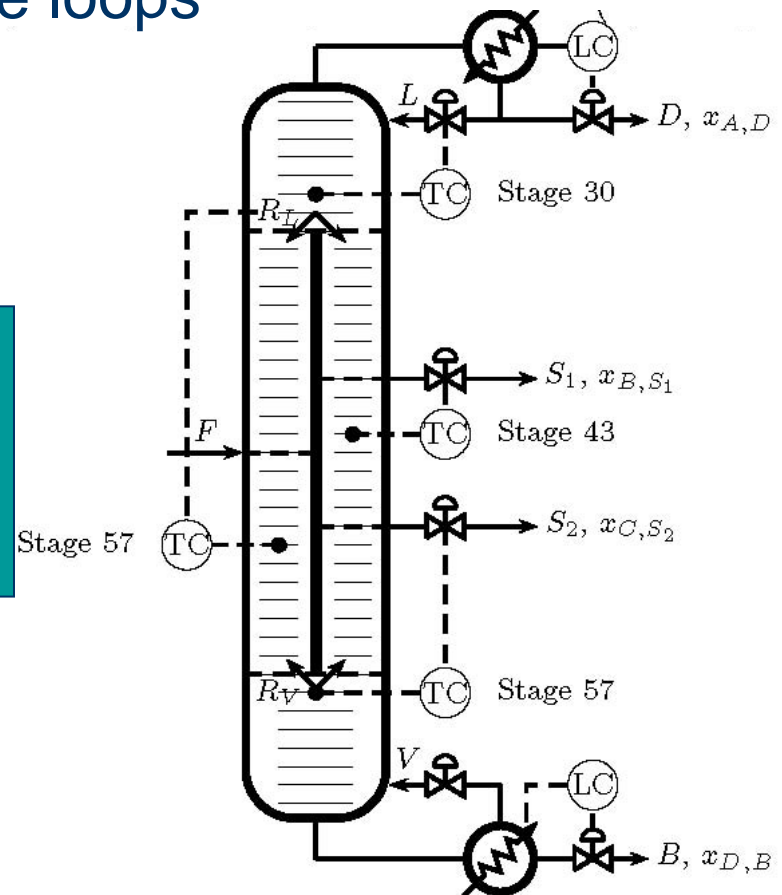

Fig. 3. A photograph of the shell and a drawing illustrating internal configuration of a DWC for separation of a four component feed into pure products.

Control study (Strandberg 2009)

Stabilizing Control by 4 temperature loops

Need to adjust liquid split online in order to stabilize prefractionator



Step response test on pilot column

Prefractionator temperature below feed controlled by adjusting the liquid split

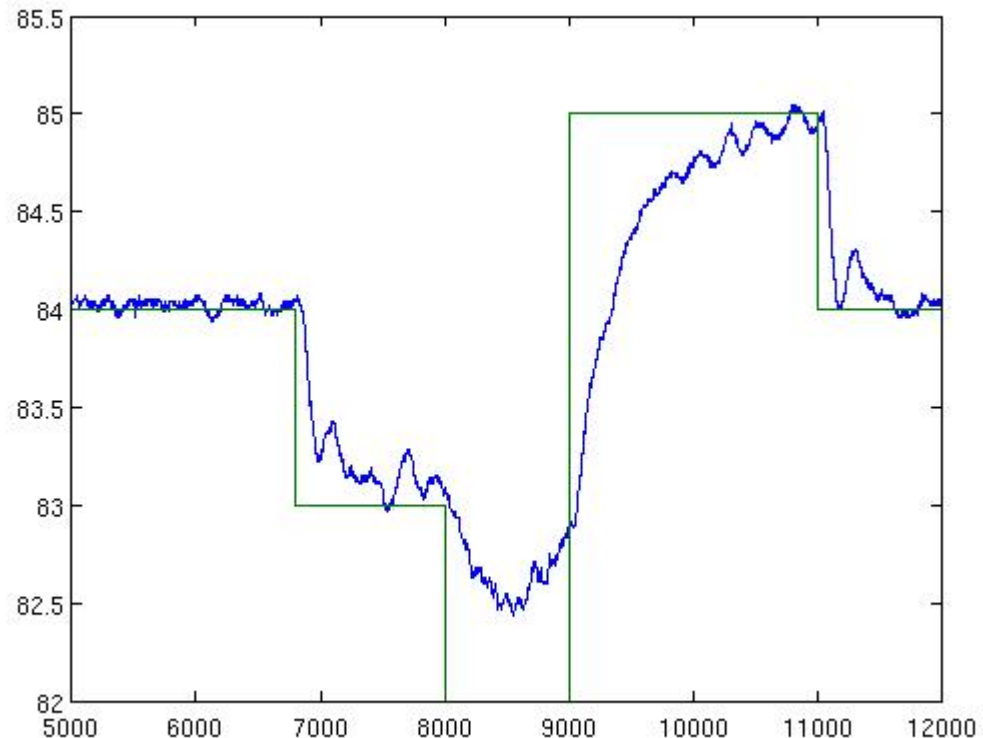

More results:

- Master thesis by Martin Kvernland 2009
- Matlab model extension includes heat loss and vapor bypass for stage inefficiency
- Implemented a 4x4 MPC with a reduced linear state space model (reduced from original >200 to 15 states)
- The MPC controller in Matlab can be interfaced to Labview via OPC

UniSim Simulation for Kaibel Column

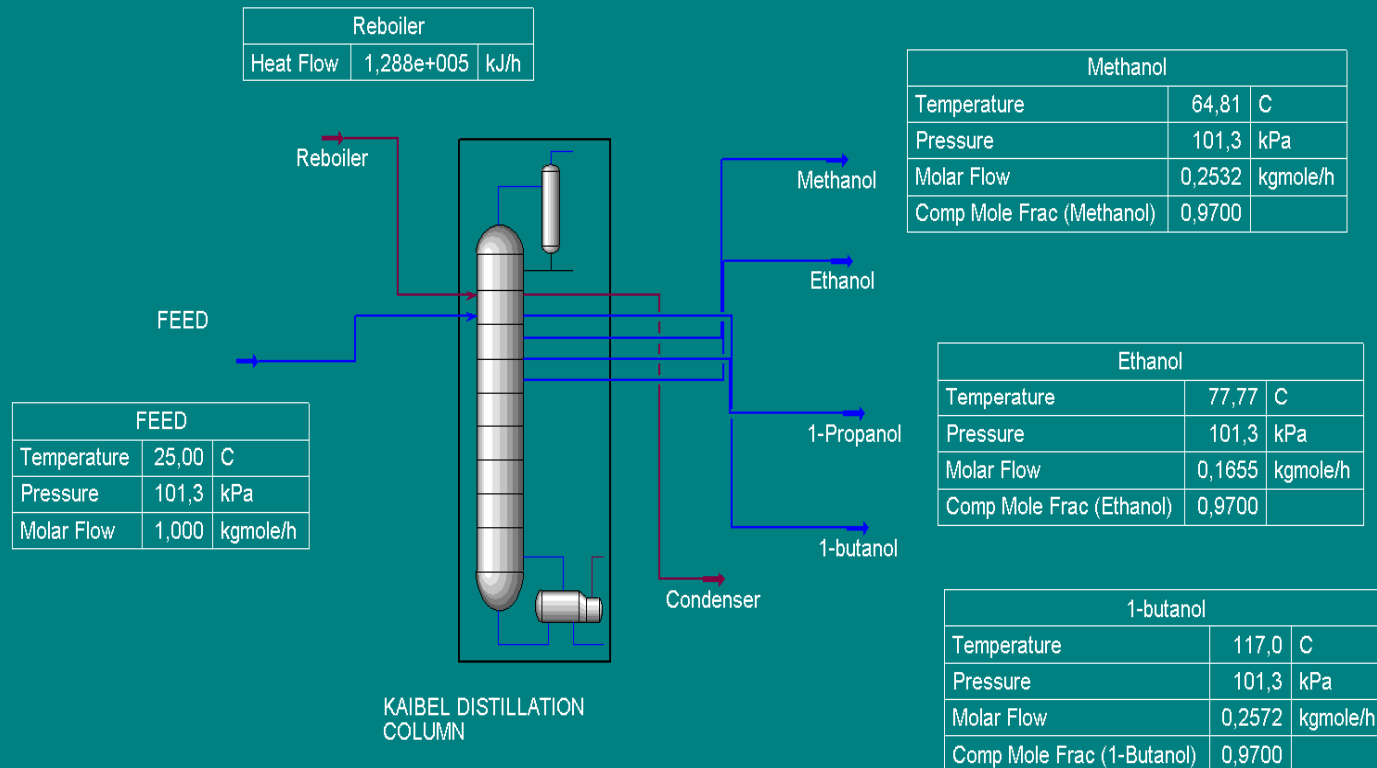

Toolbox for rigorous simulations

by Maryam Ghadrddan

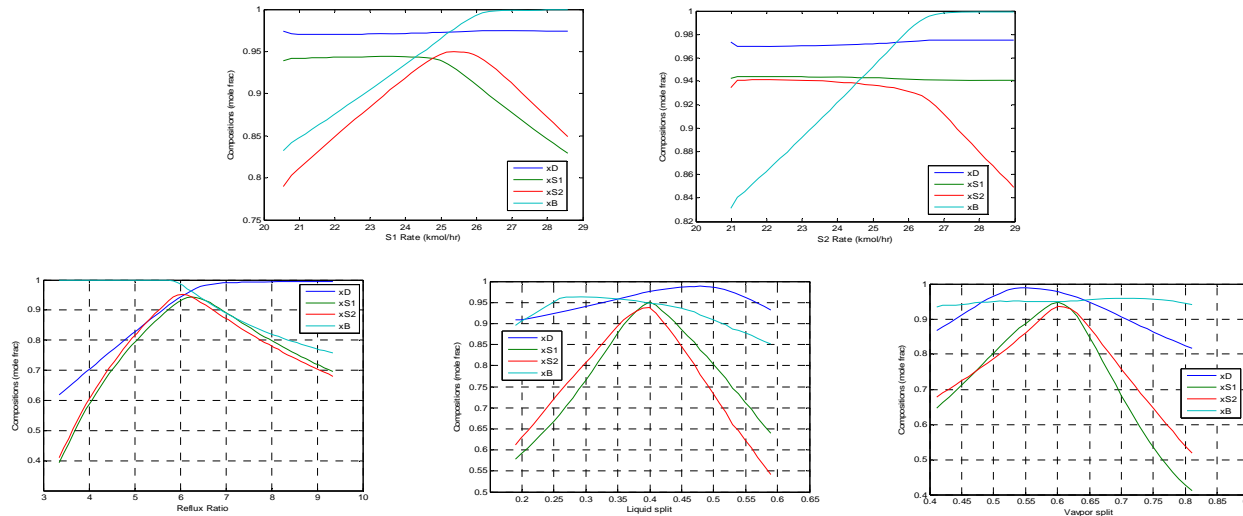
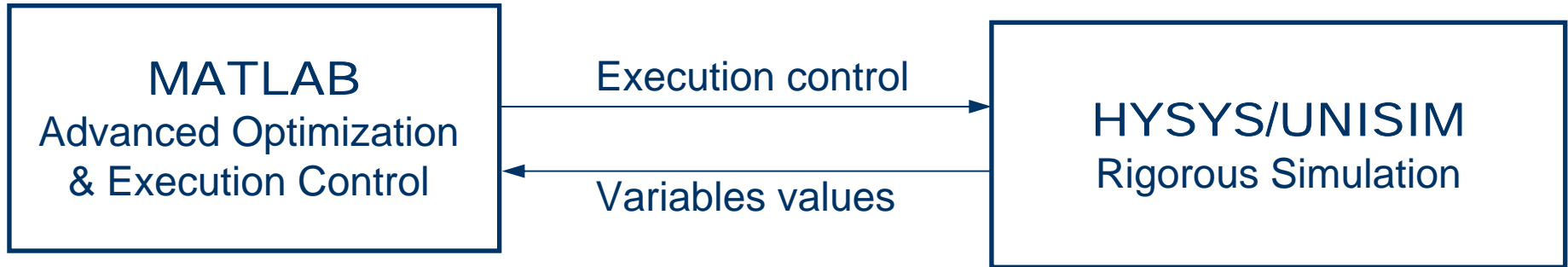

Further work

- Model development and refinement
Both in Matlab and Unisim/Hysys
- Lab column experiments
- Control structure design
(including selfoptimising control)
- Optimizing control / minimum energy control
- Optimal process design
- Extended Petlyuk arrangements
- Alternative structures like HIDiC, Heat integrated and other energy efficient arrangements

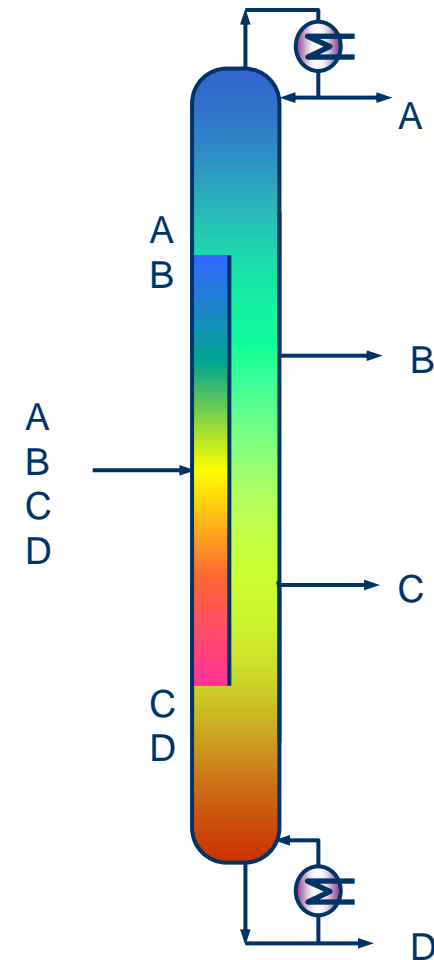

Extended 4-product Petlyuk DWC with multiple dividing walls

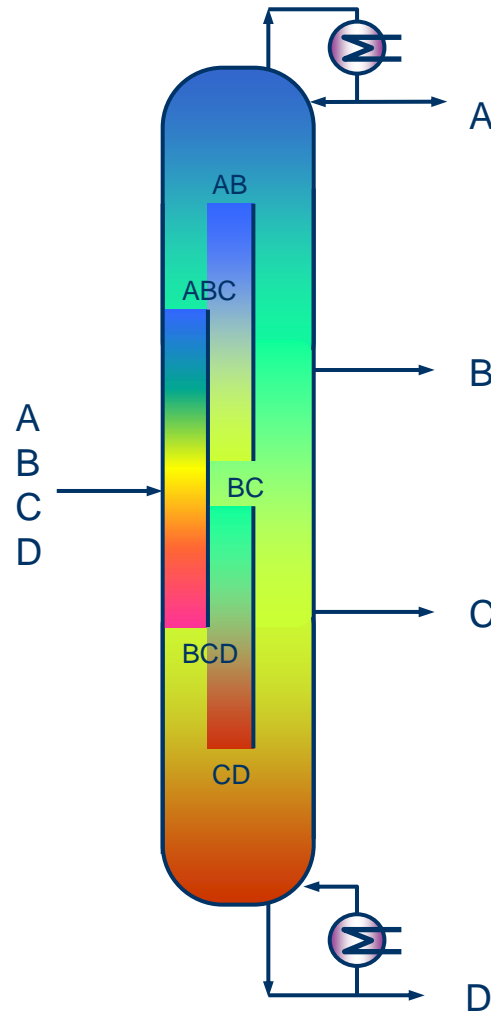

Theoretical savings up to 50%

What about complexity in design and operation?

What about revamp?

- A Butane case (butane/C5+) and butane splitter (iC4/nC4):

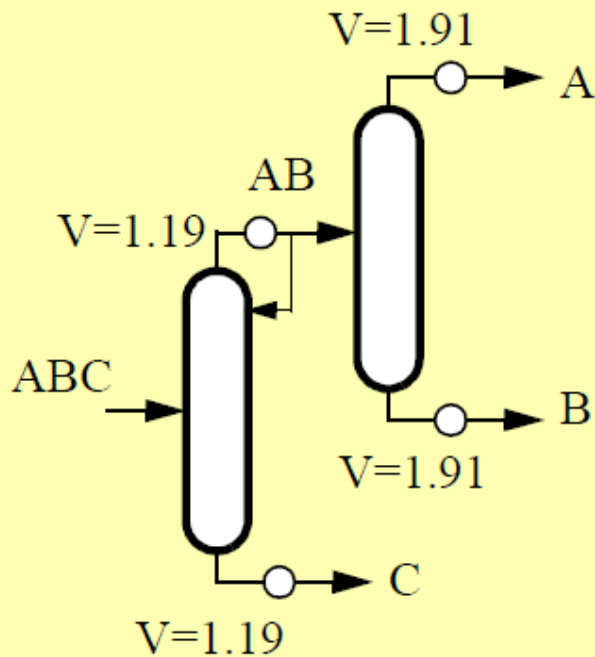

Total reboiler boilup = $3.10 \times F$

V_{min} -diagram

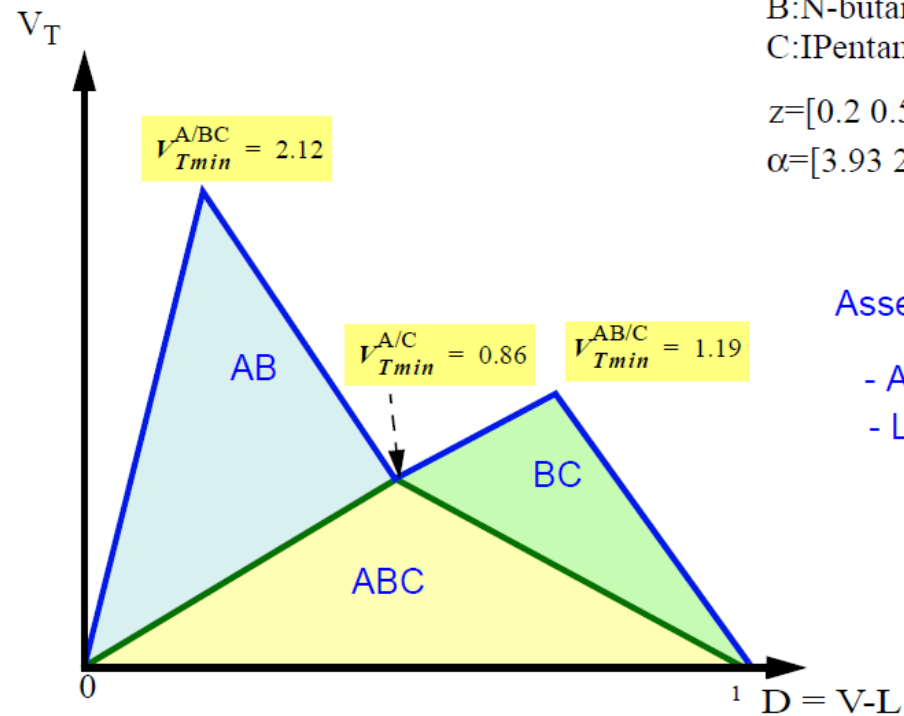

Feed: A:Isobutane
 B:N-butane
 C:IPentane and heavier
 $z = [0.2 \ 0.5 \ 0.3]$ $q=1$ $F=1$
 $\alpha = [3.93 \ 2.85 \ 1]$

Assessment:

- A/B split dominates
- Large $\Delta V = 0.93$

Add direct coupling and save 32 %

Simple revamp of existing columns is equivalent to the full Petlyuk arrangement

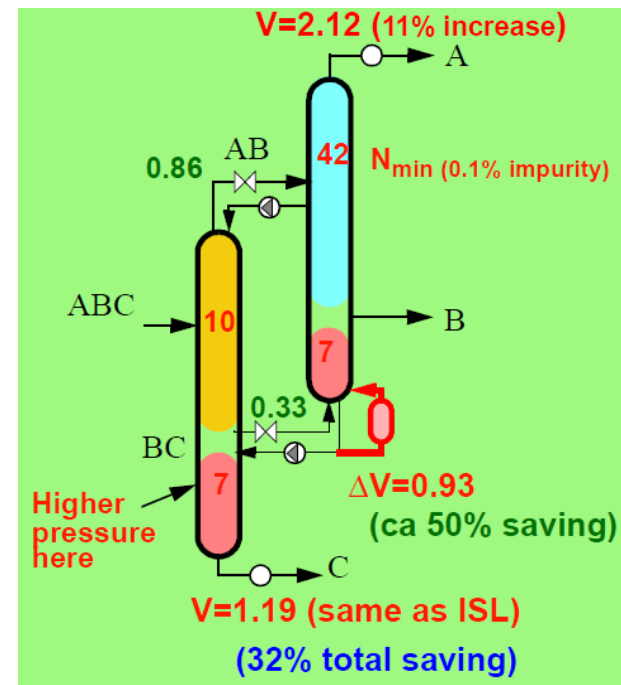
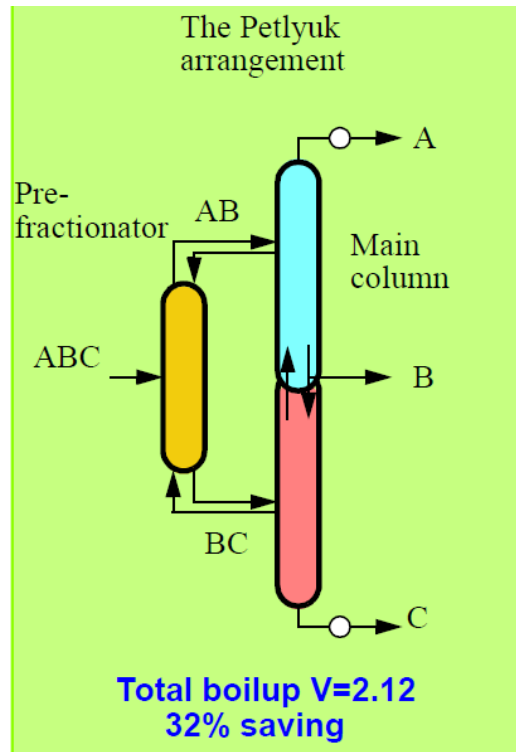

Energy Efficient Distillation

■ We can do it!