

Report

Effect of maintenance on particulate emissions from residential woodstoves

Literature review and test results from particulate matter measurements based on Norwegian Standard NS3058-59 coupled with EC and OC analyses on an artificially aged woodstove

Commissioned by the Norwegian Environment Agency

Authors

Alexis Sevault (SINTEF Energy Research), Morten Seljeskog (SINTEF Energy Research), Line Rydså (SINTEF Energy Research), Asbjørn Østnor (SP Fire Research Norway), Birger Rønning (SP Fire Research Norway), Magnus Rishaug (SP Fire Research Norway)



Address:

SINTEF Energy Research
Postboks 4761 Sluppen
7465 Trondheim
NORWAY

Enterprise /VAT No:
939 350 675

Report

Effect of maintenance on particulate emissions from residential woodstoves

Literature review and test results from particulate matter measurements based on Norwegian Standard NS3058-59 coupled with EC and OC analyses on an artificially aged woodstove

VERSION 1.0	DATE 2015-12-22
KEYWORDS: <i>Woodstove, TSP, Particulate emissions, Maintenance, Elementary Carbon, Organic Carbon, NS3058-59, Aging woodstove</i>	AUTHORS Alexis Sevault (SINTEF Energy Research), Morten Seljeskog (SINTEF Energy Research), Line Rydså (SINTEF Energy Research), Asbjørn Østnor (SP Fire Research Norway), Birger Rønning (SP Fire Research Norway), Magnus Rishaug (SP Fire Research Norway)
CLIENT Miljødirektoratet, ref. M-518 2016	CLIENT'S REF. Vigdis Vestreng
PROJECT NO. 502001164	NUMBER OF PAGES: 30

ABSTRACT

The present report focuses on the effects of maintenance of residential woodstoves on the emissions of particulate matter (TSP). The report encompasses the findings of a literature review and the experimental results from particulate measurements performed by SP Fire Research Norway in cooperation with SINTEF Energy Research, as part of a project funded by the Norwegian Environment Agency (Miljødirektoratet). The work has been motivated by the proposed action plan for Norwegian emissions of short-lived climate forcers (M89/2013) concentrating on improved combustion technology, control and maintenance of new wood stoves as a measure to reduce short-lived climate forcers from wood-fired appliances. Tests were carried out on an artificially aged woodstove. The filter setup consisted of two double filter holders with a quartz-quartz and teflon-quartz configuration. The suction probe diameter was reduced from 10 to 5.9 mm to decrease the withdrawn volume through the filters, this to avoid particle saturation of the filters related to the Sunset OCEC laboratory instrument used for the analyses. Standard procedures were used for handling the filters, i.e. baking and drying. The University of Eastern Finland analysed the filters for Elementary- (EC) and Organic Carbon (OC) components. Experimental tests followed the Norwegian Standard NS3058-59 FFD (Full-Flow Dilution Tunnel) method relying on measured particulate matter TSP collected gravimetrically on standard filters supported in standardized filter holders.

The literature review indicates that non-maintained woodstoves are usually associated with higher TSP emission factors, since any accumulating soot overtime, or for instance air leakages, will certainly alter the combustion conditions compared to the original design.

From the tests carried out within this project, TSP measurements have shown an increase after removing the seal gasket from the woodstove door, compared to similar burn rate conditions with the door gasket: twice more TSP than at nominal conditions and 28-30% higher than at equivalent, high burnrates. EC emission factors are also found 2-4 times higher than at nominal conditions. The measurements indicate that a large leakage of non-preheated air into the combustion chamber shall be avoided with regards to TSP and EC emissions.

PREPARED BY Alexis Sevault	SIGNATURE		
CHECKED BY Øyvind Skreiberg	SIGNATURE		
APPROVED BY Petter Røkke	SIGNATURE		
REPORT NO. TR A7538	ISBN 978-82-594-3649-8	CLASSIFICATION Unrestricted	CLASSIFICATION THIS PAGE Unrestricted

Document history

VERSION	DATE	VERSION DESCRIPTION
0.1	2015-11-16	Draft report sent to Miljødirektoratet for preliminary review
0.2	2015-11-27	Draft report sent to Miljødirektoratet after addressing Client's reviews, completing the literature review and adding further argumentation based on results and literature
0.3	2015-12-03	Draft report – addition of summary in Norwegian, administrative details and minor corrections
0.4	2015-12-22	Addressed reviews from Miljødirektoratet – addition of extra results (tests at high burnrate with EC/OC analysis) to strengthen conclusions – Ready for final internal QA

SAMMENDRAG

I forslag til handlingsplan for norske utslipp av kortlevde klimadrivere (M89/2013) skisseres bedret fyringsteknikk, og ettersyn og vedlikehold av nye vedovner som tiltak for å redusere utslipp av kortlevde klimadrivere fra vedfyring. Denne rapporten fokuserer på effekten av vedlikehold av vedovner på utslipp av svevestøv, elementært karbon (EC) og organisk karbon (OC). Rapporten omfatter funn fra en litteraturgjennomgang og resultater fra eksperimentelle partikkelmålinger utført av SP Fire Research Norge i samarbeid med SINTEF Energi AS. Arbeidet har vært en del av et prosjekt finansiert av Miljødirektoratet, Norge. Tester ble utført på en kunstig aldret vedovn.

Oppsett av filtertog er basert på anerkjent metode som benyttes ved måling av luftkvalitet. To doble filterholdere satt opp med kvarts-kvarts og teflon-kvarts konfigurasjon ble benyttet. For å unngå overbelastning av partikler på filtrene ble sonediameteren redusert fra 10 mm til 5.9 mm, noe som reduserer avsugd mengde røykgass med rundt en tredjedel. Dette gjør at man får avsatt en redusert mengde partikler på filtrene og dermed betraktelig øker sannsynligheten for at disse kan analyseres i Sunset lab's OCEC instrument uten at signalene går i metning. Hastigheten i uttynningstunellen holdes på 4.4 m/s som beskrevet i Norsk standard for å sikre isokinetisk prøvetaking.

Analysen av EC og OC på filtrene ble utført av University of Eastern Finland. I de eksperimentelle testene ble metoden Norsk Standard NS3058-59 FFDT (Full-Flow Dilution Tunnel) fulgt, som baserer seg på å måle svevestøv (total partikkelmasse, TSP) som blir samlet gravimetrisk på vanlig filtre som settes i standardiserte filterholdere. Litteraturgjennomgangen viste at vedovner som ikke er vedlikeholdt vanligvis er forbundet med høyere utslippsfaktorer for TSP. Dette kommer av at akkumulert sot, eller luftlekkasjer for eksempel, over tid med sikkerhet vil endre forbrenningsforholdene sammenlignet med det opprinnelige designet. Fra de testene som har blitt utført i dette prosjektet, har målinger vist at TSP øker etter fjerning forseglingen (pakningen) fra vedovnsdøren, sammenlignet med lignende forbrenningshastighetsforhold. Målingene viste dobbelt så mye TSP her, enn ved optimal vedomsetning (oppgitt av produsent i kW), og 28-30% mer TSP enn ved tilsvarende, høy forbrenningshastighet. Utslippsfaktorer for EC er også funnet til å være 2-4 ganger høyere enn ved nominelle forhold. Målingene indikerer at en stor lekkasje av ikke-forvarmet luft inn i forbrenningskammeret, bør unngås med hensyn til utslipp av TSP og EC.

Table of contents

1	Introduction	4
2	Literature review on influence of maintenance on particulate emissions.....	5
3	Experimental investigation on influence of air leakage on particulate emissions	10
3.1	Experimental setup	10
3.2	TSP emissions measurements.....	16
3.2.1	Experimental results	16
3.2.2	Observations during the tests	16
3.2.3	Analysis of TSP emissions results.....	20
3.3	EC/OC analysis.....	23
4	Conclusions and recommendations	26

Table of Abbreviations

AES	Automated emission sampler
TSP	Total suspended particulate mass. Also expressed as PMt, Particulate Matter Total.
BC	Black Carbon
EC	Elementary Carbon
EPA	Environment Protection Agency
FFDT	Full-Flow Dilution Tunnel
HF	Heated Filter
OC	Organic Carbon
ESP	Electrostatic precipitator
PTFE	Teflon filters - polytetrafluorethylene
EAD	Emissions ADjusted (due to particle losses in the dilution tunnel), $EAD = 1.82 \times E^{0.83}$
E	Particulate part of emissions, (g/h)

1 Introduction

The present report focuses on the effects of maintenance of residential woodstove on the emissions of particulate matter. The report encompasses the findings of a literature review and the experimental results from particulate measurements performed by SP Fire Research Norway in cooperation with SINTEF Energy Research, as part of a project funded by the Norwegian Environment Agency (Miljødirektoratet). The work has been motivated by the proposed action plan for Norwegian emissions of short-lived climate forcers (M89/2013) concentrating on improved combustion technology, control and maintenance of new wood stoves as a measure to reduce short-lived climate forcers from wood-fired appliances. The University of Eastern Finland performed the analysis of EC and OC components on the filters. Experimental tests followed the Norwegian Standard NS3058-59^{1,2} FFDT (Full-Flow Dilution Tunnel) method relying on measured particulate matter (TSP) collected gravimetrically on standard 90-100 mm filters supported in typical filter holders. Additional simultaneous TSP measurements on heated filters set up in a similar way to the one described in the measurement standard EN13240 DIN+³ were performed to complement the results.

The work and results described in the present report constitutes the second part of a project funded by the Norwegian Environment Agency (Miljødirektoratet). The first part focused on highlighting the influence of some of the most important variables, inherent to standards EN13240 DIN+³ relying on HF (Heated Filter) and method and NS3058-59^{1,2} relying on a FFDT method, regarding the amount of measured particulate matter TSP collected gravimetrically on standard filters supported in standardized filter holders. The tested variables were the nature of the test fuel, the fuel load, the burn rate and the test duration, applying simultaneous measurements on tests performed following each of the two standards for comparison. Both methods and the results from the first part of the project are described in an independent report⁴.

Residential woodstoves have been identified as significant sources for particulate emissions to air, i.e. TSP (28%) and PM10 (46%) of the total Norwegian emissions⁵. Hence, several countries have introduced emissions control requirements for domestic wood-based heating appliances. Woodstoves entering the European market must at least be approved according to the common EU standard EN 13240, often with the addition of the DIN+, regulating the particulate emissions. This standard sets regulations for safety, efficiency and CO emissions, though currently not for particulate emissions. Some countries have established emission limits for particulate emissions and developed measuring methods. The European Committee for Standardization, CEN/TC 295, has for several years worked on a common method for particulate matter (TSP) measurement. By the end of 2015, three established methods are described in the technical specification CEN/TS15883⁶, i.e. the Heated Filter (13240 DIN+), the Dilution tunnel NS 3058 (The Norwegian method) and the ESP (Electrostatic precipitator or the English method). The two most commonly used measurement methods for particles in Europe are the Norwegian Standard for Enclosed wood heaters using particle sampling in a dilution tunnel^{1,2} and the DIN+³ certification scheme with hot flue gas particle sampling directly in the chimney. The use of these two methods will result in variation in measured emission levels, mainly due to variation in the mass of condensable matter due to differences in the test procedures. In the present report, the TSP measurements were performed simultaneously combining both methods, following thoroughly the

¹ NORSK STANDARD, NS-3058 (1994), "Enclosed wood heaters, Smoke emission"

² NORSK STANDARD, NS-3059 (1994), "Enclosed wood heaters, Smoke emission – Requirements"

³ DIN+ certification scheme: "Room Heaters (Solid Fuel Stoves) with low-pollution combustion according to DIN EN 13240"

⁴ Seljeskog, Sevault, Østnor, Rønning and Rishaug, *Factors affecting emissions measurements from residential wood combustion*, SINTEF Energy research, Report, 2016

⁵ <http://ssb.no/milgiftn/>

⁶ CEN/TS 15883:2009, "Residential solid fuel burning appliances – Emissions tests methods"

test procedures and setup given in NS3058-59^{1,2} and HF (above 70 °C) to allow comparison of measured TSP for any given tests.

Several recent studies^{7,8} have emphasized that beyond the initial certification performed on residential woodstoves, the maintenance of the appliance itself may have significant consequences on the combustion processes, and consequently, the emissions from aging clean-burning stoves. However, a quantification of the effect of maintenance on TSP emissions and EC/OC concentrations is still missing in the literature regarding the newer models of low emissions wood stoves.

The goal of the present report is to bridge the aforementioned gap, with a special focus on the Norwegian context. The results shall lay off recommendations for the best practice of maintenance of aging modern residential woodstove in Norway to avoid increased particulate emissions due to stove wearing.

The current emission requirements for non-catalyst wood heaters, as provided by the aforementioned Norwegian Standard, are:

- 20 g/kg for the maximum allowable emission for one test
- 10 g/kg for the maximum weighted mean value

The appliance selected for the current project was carefully chosen on the premises of being a modern, highly efficient low-emission stove with a reasonably low nominal effect of 5 kW. It has previously been certified according to NS3058-59^{1,2} with weighted emissions of 2.1 g TSP/kg dry wood.

Despite the relatively low TSP emissions recorded for the selected appliance, the EC/OC analysis can be jeopardized by an overload of EC on the filter if NS3058-59^{1,2} for TSP emission measurement is strictly followed, as highlighted by the BlackOut project⁷. A successful method circumventing this issue is described in Chapter 3.1.

The first part of the report focuses on the literature findings about the most significant effects of maintenance on TSP emissions. The second part of the report focuses on a comparison of TSP, EC and OC emissions from experimental tests realized on an artificially aged modern woodstoves, before and after alteration.

2 Literature review on influence of maintenance on particulate emissions

The literature treating maintenance of residential woodstoves generally starts by distinguishing catalytic models and non-catalytic models. This is especially linked to a wave of American projects funded by the Environment Protection Agency and focusing essentially on maintenance. Unlike the USA, Norway counts only a relatively low share of catalytic woodstoves among all residential woodstoves. Consequently, the catalytic models are treated in the next paragraph and only non-catalytic woodstoves are considered in the remaining of the report, since they better represent the Norwegian context.

⁷ Seljeskog M., Goile F., Sevault A., Lamberg H., "[Particle emission factors for wood stove firing in Norway](#)", Black-Out project report (2013), ISBN 978-82-594-3607-8

⁸ ACAPWOOD report: "[Reduction of Black Carbon Emissions from Residential Wood Combustion in the Arctic](#)", 2015

The catalytic models are, by definition, relying on the catalyst to reduce the amount of particulate emissions, while non-catalytic models rely instead on mechanical features, e.g. baffles and secondary combustion chambers. Several studies^{9,10,11,12,13,14} clearly highlight that the catalyst degrades with the number and intensity of heating cycles. As it degrades, the TSP emission rates increase and the wood heater efficiency decreases. Since their design does not usually include any other major features for TSP reduction, when the catalyst is fully degraded, catalyst woodstoves can generally emit as much TSP as uncertified conventional heaters. Therefore, the degradation of catalytic woodstoves and its impact on TSP emissions can be more significant than with non-catalytic woodstoves. This fact is known and forms the reasoning requiring catalytic residential woodstoves to emit less than 50% of the maximum requirements applicable to the non-catalytic appliances, as found in the Norwegian Standard NS3059². Renewing the catalyst every 5 years is generally recommended as a good practice to avoid dramatic impacts on TSP emissions and efficiency.

Beyond the specific case of the catalytic woodstoves, recommended maintenance of any residential woodstoves^{7,8,15,16,17,18} often refers to a well-defined set of actions onto the whole wood-based heating system, namely:

- Remove soot from the fireplace glass, as it blocks direct radiation from the flame.
- Empty the ashes, though not too often. The ash insulates and protects the bottom and the grate underneath the fire.
- Inspect and replace if necessary, the door gaskets and adjust air-tightness of the door.
- Annual maintenance: remove the top baffle plate and burn plates (detachable inner plates) for inspection to ensure they are in good shape. Remove any ash accumulated between the outer walls and the burn plates. Replace any worn internal parts.
- Contact a professional regularly to sweep the chimney (in Norway a minimum of every four years).

These actions are mostly linked to the ways in which particulate matter (TSP) can be emitted from wood combustion processes. Thorough reviews found in the literature^{19,20} form the basis of the next paragraphs,

⁹ Houck J.E., Pitzman L.Y. and Tiegs P., "[Emissions Factors for New Certified Residential Wood Heaters](#)"

¹⁰ Bighouse, R.D., Barnett, S. G., Houck, J.E., and Tiegs, P.E., "[Woodstove Durability Testing Protocol](#)", Prepared for the U.S. Environmental Protection Agency by OMNI Environmental Services, Inc., Beaverton, OR, 1994, EPA-600/R-94-193 (NTIS PB95-136164)

¹¹ Bighouse, R.D., Houck, J.E., Barnett, S.G., and McCrillis, R.C., "[Stress Testing of Woodstoves](#)" In Proceedings of the Air and Waste Management Association 86th Annual Meeting, Denver, CO, June 14-18, 1993, paper 93-RP-136.05

¹² Fisher, L.H., Houck, J.E., and Tiegs, P.E., "[Long-Term Performance of EPA-Certified Phase 2 Woodstoves, Klamath Falls and Portland, Oregon: 1998/1999](#)", Prepared for the U.S. Environmental Protection Agency by OMNI Environmental Services Inc., Beaverton, OR, 2000, EPA-600/R-00-100

¹³ Champion, M. and Jaasma, D.R., "[Degradation of Emissions Control Performance of Wood Stoves in Crested Butte, CO](#)", Prepared for the U.S. Environmental Protection Agency by Virginia Polytechnic Institute and State University, Blacksburg, VA, 1998, EPA-600/R-98-158 (NTIS PB99-127995)

¹⁴ Barnett, S.G. and Fesperman, J., "[Field Performance of Advanced Technology Woodstoves in Their Second Season of Use in Glens Falls, New York, 1990](#)", Prepared for Canada Centre for Minerals and Energy Technology; Energy, Mines, and Resources by OMNI Environmental Services, Inc., Beaverton, OR, 1990

¹⁵ Jøtul AS, Website – www.jotul.com (Visited: 02.11.2015)

¹⁶ Website: <http://www.chimneysweepnews.com/epasays.htm> (Visited:04.11.2015)

¹⁷ Environment Protection Agency (EPA), "[Federal Register, Standards of Performance for New Residential Wood Heaters, New Residential Hydronic Heaters and Forced-Air Furnaces; Final Rule](#)", March 2015

¹⁸ Houck J.E. and Tiegs P.E. "[Residential Wood Combustion Technology Review, Vol. 1](#)". Technical Report (Dec. 1998)

¹⁹ Bond T.C., et al., "[A technology-based global inventory of black and organic carbon emissions from combustion](#)", Journal of Geophysical Research, VOL. 109, D14203, doi:10.1029/2003JD003697, 2004

²⁰ Lighty, J. S., J. M. Veranth, and A. F. Sarofim, "[Combustion aerosols: Factors governing their size and composition and implications to human health](#)", J. Air Waste Manage. Assoc., 50, 1565 – 1618, 2000

though it should be kept in mind that the formation of "soot" is an area with many unresolved questions. Fine particles (inferior to 2.5 μm , also known as PM_{2.5}) have different sources than the coarser particles in combustion. The fine particles (dust in suspension) are generally of higher interest as they have both longer atmospheric lifetimes and greater scattering and absorption efficiencies than coarse particles. Like PM₁₀, they can be inhaled and accumulate in the respiratory system. However, PM_{2.5} also represent a more severe health hazard^{21,22} due to their small size, since they can lodge deeply into the lungs, penetrate arteries and lead to cardiovascular diseases²³. They origin from the combustion processes itself and are generally composed of Black Carbon (BC) and OC. BC is generally used to account for both EC and Graphitic Carbon (graphite-like micro-crystalline structures) and is the component of the soot highly absorbing in the visible range.

BC usually forms under fuel-rich conditions, where oxygen is insufficient to complete the oxidation of carbon-fuel to CO₂. Such fuel-rich zones inherently exist in diffusion flames where the combustion reactions are limited by the local mixing of air and fuel. Consequently, the formation and destruction of BC cannot be predicted from overall stoichiometry (overall balance between air and fuel) but is rather limited by reaction kinetics and small-scale processes. It is therefore nearly impossible to have a general correlation between the main combustion products, such as CO₂ or CO for instance, and BC levels. It is also known that soot may burn out in a post flame zone provided that oxygen is present (as in secondary combustion zone of modern woodstoves) and this process is enhanced at higher temperature. This fact alone suggests that, for instance, cold air leaking into the combustion chamber of non-maintained modern woodstove would alter the efficiency of the secondary combustion zone and eventually yield higher BC levels than expected.

OC is also emitted through the combustion processes. It origins from organic vapours which can condense onto existing particles, or form particles by nucleation provided a sufficiently high concentration. Organic vapours may origin from incomplete combustion or from, for instance, low-temperature wood pyrolysis releasing organic material, which condenses quickly after emission. Incomplete combustion and pyrolysis phase (charcoal phase) are typically found in low burnrate combustion, suggesting higher OC levels than in nominal conditions. Inorganic compounds may also be found within the fine particles after they form by vaporization of mineral and then condensate again. They may as well come from bursting of mineral inclusion from the wood. Although inorganic compounds might represent a significant part of the TSP emissions, they cannot be taken away through oxidation mechanisms within the combustion processes.

Several studies^{10,12,24} have also demonstrated how the degradation of (non-catalytic) woodstoves would significantly affect the combustion conditions, up to a point where one would expect increased TSP emissions. The degradation of the woodstoves is seen to be especially dramatic when a woodstove is allowed to operate at exceptionally high temperatures. Bighouse^{10,11} reported on woodstove field studies during seven heating seasons and highlighted that new technology woodstoves designed to have low particulate emissions have frequently shown rapid degradation in emission control. This degradation has been documented both by measurement of particulate emission factors with an in-home automated emission sampler and by observable physical damage to the woodstove components. Fisher¹² reported of particulate emissions from low-emission certified woodstoves installed in homes and used regularly for home heating since the 1992/1993 heating season or earlier. Sixteen stoves were evaluated in the study. An extensive database from 43 weeklong test

²¹ Miljødirektoratet, "[Forslag til handlingsplan for norske utslipp av kortlevde klimadrivere](#)", Report M-89 (2014)

²² Janssen, N. A. H., m. fl., "[Black Carbon as an Additional Indicator of the Adverse Health Effects of Airborne Particles Compared with PM10 and PM2.5](#)", Environmental Health Perspectives, 119(12), 1691-1699 (2011)

²³ Aaron J. Cohen, H. Ross Anderson, Bart Ostro; Ross Anderson, H; Ostro, B; Pandey, K. D.; Krzyzanowski, M; Künzli, N; Gutschmidt, K; Pope, A; Romieu, I; Samet, J. M.; Smith, K. "[The Global Burden of Disease Due to Outdoor Air Pollution](#)". *Journal of Toxicology and Environmental Health, Part A*: **68** (13–14): 1301–7 (2005)

²⁴ Burnet, "[Particulate, Carbon Monoxide and acid emission factors for residential wood burning stoves](#)", Journal of the Air Pollution Control Association, 36 (9), 1986

runs was developed. The particulate emission factors of the certified low-emission stoves evaluated in this study appear to have increased with use, though on average, after about 7 years, still have lower emissions than uncertified conventional stoves.

Most of the cited studies pointed out that modern woodstoves might require more frequent maintenance and special attention than the previous technologies, to keep up their performance and their benefits. A modern low-emission woodstove generally relies on an airtight combustion chamber where the flow rate of incoming air is controlled. Without proper maintenance, such stoves might have a tendency to start leaking after a number of years, especially around the door gasket. The cold air entering the combustion chamber at uncontrolled locations leads to a degradation of the combustion conditions and TSP emissions a priori up to the same range as old-type stoves where air inlets were not fully controlled.

It was mentioned several times in the reviewed literature that the state of the chimney itself matters, especially in terms of potential leakages. A modern woodstove operating with an old leaking chimney would not be able to achieve the expected low TSP emissions.

Trondheim Feiervesen (Chimney Sweeps' organisation in Trondheim, Norway) carried out a project^{25,26} in 2009 on the effect from sweeping the inner side of woodstoves and compared the temperature of the wall of the woodstoves before and after the sweeping, using a thermal camera. Soot is highly insulating, and in most of the experiments, higher surface temperatures were measured after the woodstove had been internally swept to remove soot (see Figure 1). They also measured the wall temperature at regular intervals for the first 15-20 minutes after ignition and captured a significantly higher temperature gradient over time after the sweeping (see one example in Figure 2). This resulted in higher heat release over the first 15-20 minutes, which is generally the effect sought after when igniting a woodstove.

They observed a similar behaviour on 21 of the 23 different woodstoves they tested. For two thirds of them the temperature increase of the wall was in the range 5-30 °C, while the remaining third was around 31- 76 °C, within 15-20 minutes after ignition. To illustrate that with a rough calculation, take a cast iron woodstove of around 80 kg, an increase of its wall temperature by 30 °C within the first 20 minutes represents up to an extra 1 kW of heat release to the room through its walls over that period. Beyond the consequently 5-20 % higher efficiency, this means also that fewer wood logs need to be burnt to achieve a sought heating effect, leading in turns to less TSP emitted. Trondheim Feiervesen concluded the study by recommending regular sweeping of woodstoves to keep both a high energy efficiency and low particulate emissions.

²⁵ [Gode råd om feiing og effektiv energibruk](#), Trondheim Kommunale Feiervesen, 2009

²⁶ [Feiing og effektiv energibruk](#), Trondheim Kommunale Feiervesen, 2009

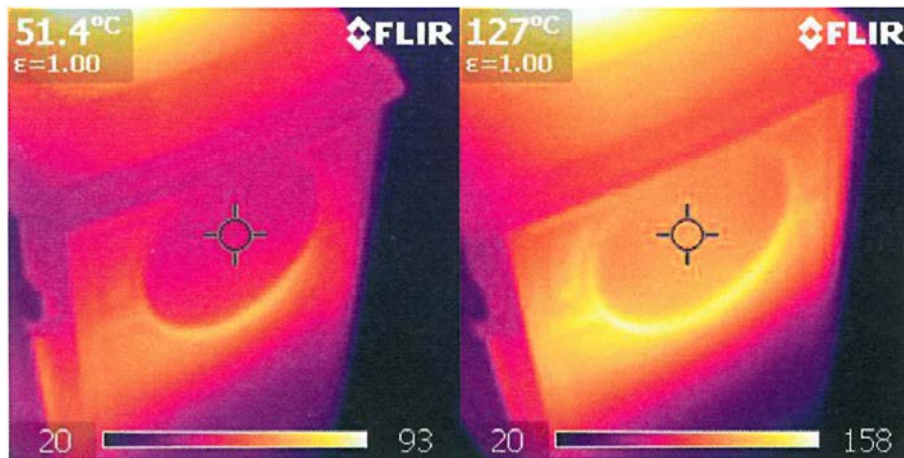

Figure 1: Left: before sweeping, 15 minutes after ignition. Right: after sweeping, 15 minutes after ignition. The temperature scale at the bottom of the figure is given in degree Celsius.

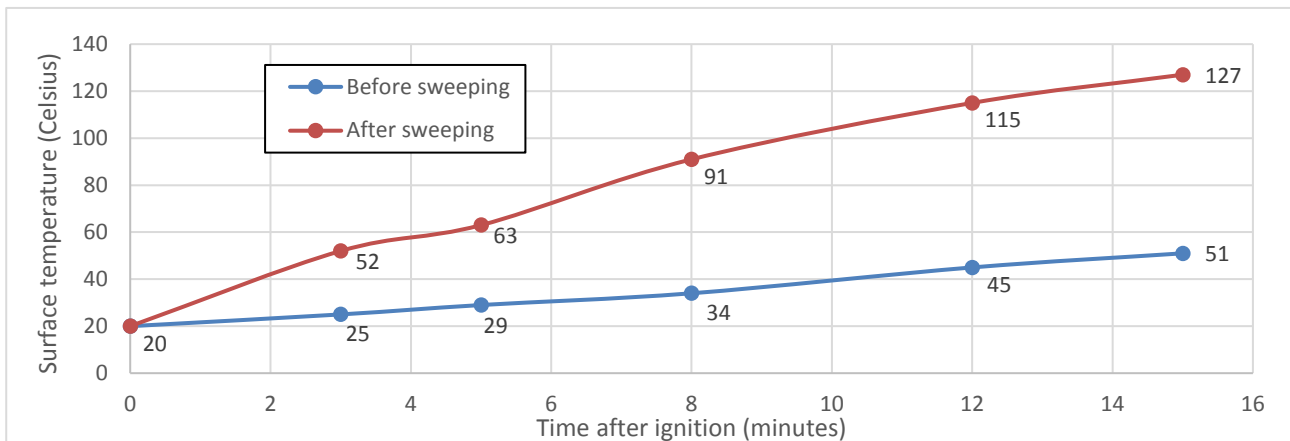

Figure 2: Example of temperature measurements by thermal camera of right side of Dovre woodstove before and after sweeping. Adapted from [9].

In Norway²⁷, the cities have the obligation by law to implement a scheme for chimney sweeps in their jurisdictions for every household at least every four years, while the chimney owners are obliged by law to enable access to the professional chimney sweeps to their facilities. Since 2002, chimney sweeps are also to inspect the state of residential fired-heaters besides the chimney, and provide advice regarding the proper functioning and maintenance of the appliances. They can also decide on having more frequent sweeps than once every four years if need be. In various Norwegian cities, chimney sweeps provide as well on-demand cleaning of fired-heaters, similar to the actions described in the report from Trondheim Feiervesen²⁶. Though first implemented for fire-safety due to fires initiated by chimney fire, such measures also serve the purpose of reducing the TSP emissions from aging residential woodstoves.

²⁷ FOR-2002-06-26-847 "*Forskrift om brannforebyggende tiltak og tilsyn*", Justis- og beredskapsdepartementet, 2002.

Other recommended measures for maintenance of wood-fired appliances are up to the users. Interventions from woodstove experts in the Norwegian media^{28,29,30} are being performed on a regular basis to remind the Norwegian users of some simple rules to keep their appliances clean and functional. The emission levels of the most recent woodstoves have become so low (1-3 g/kg versus legal limitation of 10 g/kg^{1.2}) that they can only be kept at so low levels if the appliance remains like new and if the user strictly operates it as described by the manufacturer. Any accumulating soot over time or air leakages for instance, will certainly alter the combustion conditions compared to the original design.

It should be noted that no information was found in the literature regarding the effect of maintenance and aging of woodstoves onto the EC and OC distributions in measured particulate emissions.

3 Experimental investigation on influence of air leakage on particulate emissions

3.1 Experimental setup

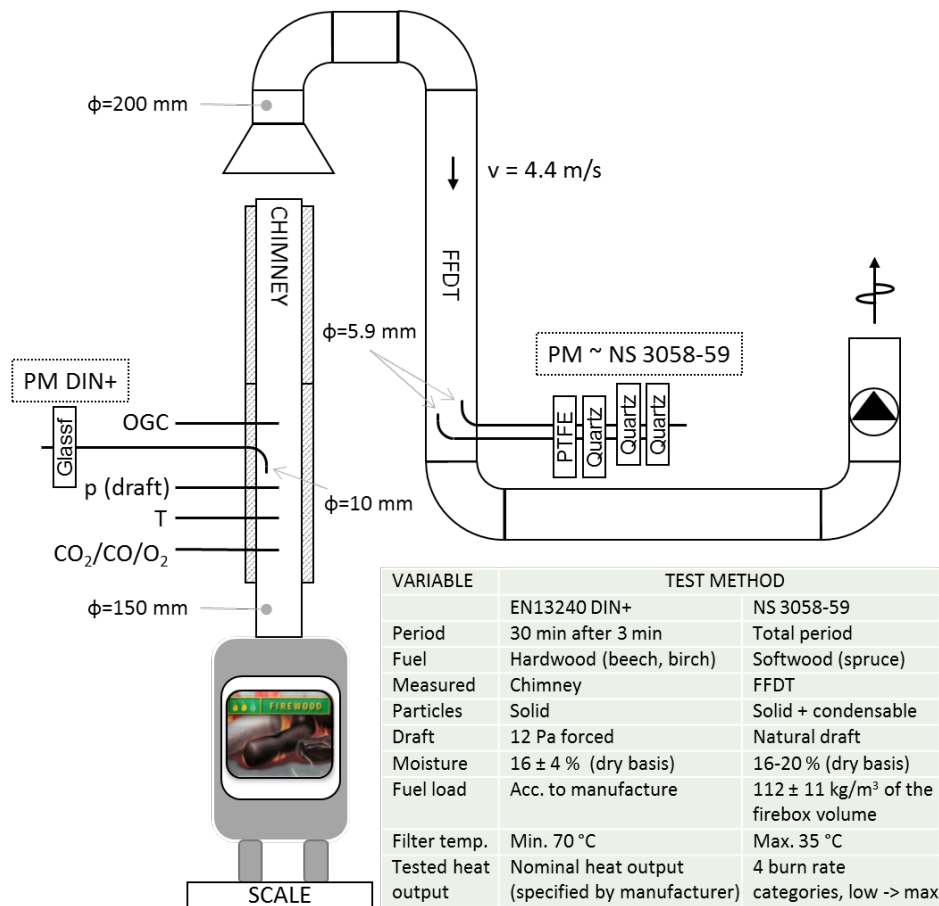

Figure 3: The combined experimental setup, simultaneous sampling on HF and in FFDT.

²⁸ "Disse tingene må du huske å gjøre før du fyrer i peisen", Vebenstad M.A., Seljeskog M., Halvorsrød M.S., klikk.no, 21.11.2015

²⁹ "Sjekk om du bør ha feier på besøk", Vebenstad M.A., Seljeskog M., Halvorsrød M.S., klikk.no, 20.10.2015

³⁰ Films, brochures and articles hosted on the Norwegian Environment Agency website:

<http://www.miljodirektoratet.no/no/?query=vedfyring&q=vedfyring>

The experimental setup in the current project is illustrated in Figure 3, including a table showing the most relevant properties of the measurements standards EN13240 DIN+³ and NS3058-59^{1,2}. During all experiments, particulate matter was simultaneously sampled both on a HF and in the FFDT. The setup was run in accordance with Norwegian Standard NS 3058-59^{1,2}. The mass of the test fuel is given by the dimensions of the combustion chamber as $112 \pm 11 \text{ kg/m}^3$ of the firebox volume.

The appliance selected for the current project was carefully chosen on the premises of being a modern, highly-efficient low-emission stove with a reasonably low nominal effect of 5 kW. Note that, unlike in the BlackOut project⁷, it is not meant to represent the average new (meaning "sold after 1998") stoves sold in Norway, but rather an example of the modern upcoming generation of woodstoves yielding very low emissions. The stove has a typical modern insulated combustion chamber using two-stage combustion, air pre-heating and window flushing from the top. It has been certified according to NS with weighted emissions of 2.1 g TSP/kg dry wood. According to EN13240 it has an efficiency of around 80%. Leakage at 25 Pa is about 10.5 m³ per hour. However, it has a small peculiarity compared to average certified woodstoves available in the Norwegian market⁷, i.e. its TSP emissions slightly increase as the heat output increases above the nominal value. This is a phenomenon expected on highly efficient low emissions woodstoves, since they are optimized for a specific and narrow range of burnrate. Note that, above the nominal output, the measured TSP levels are still generally lower than with an average certified woodstove at nominal output.



Figure 4: Experimental setup for measurements of particulate emissions with HF above the woodstove (left). The flue gas is diluted further upstream, through the hood (centre), for simultaneous FFDT sampling (right). *Note that the selected woodstove has been intentionally masked, as requested by the manufacturer.*

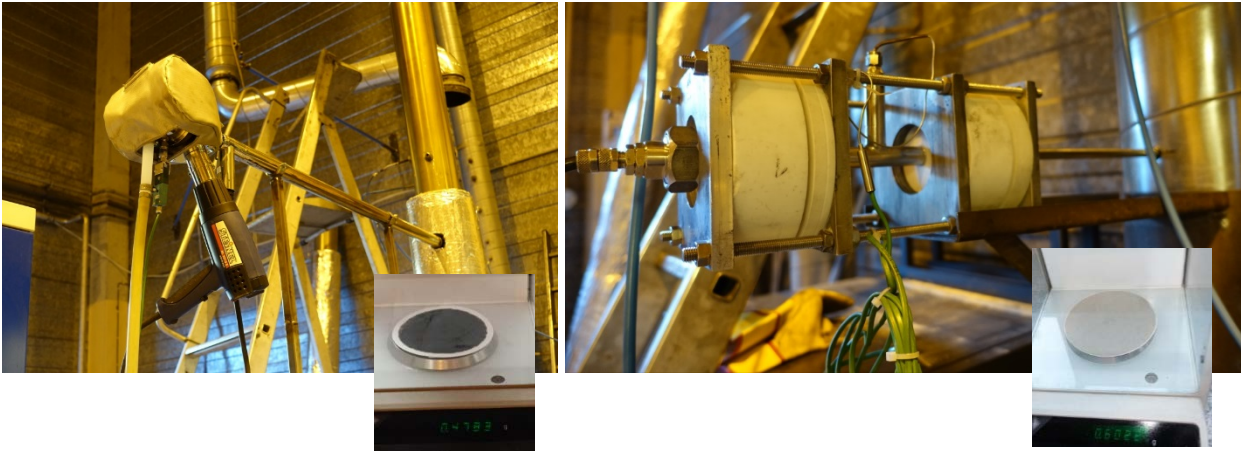

Figure 5: Experimental setup: close-up of HF (left) and one of the two double-filter holders for FFDT (right). Pictures were added to illustrate the typical filter colorization inherent to each method.

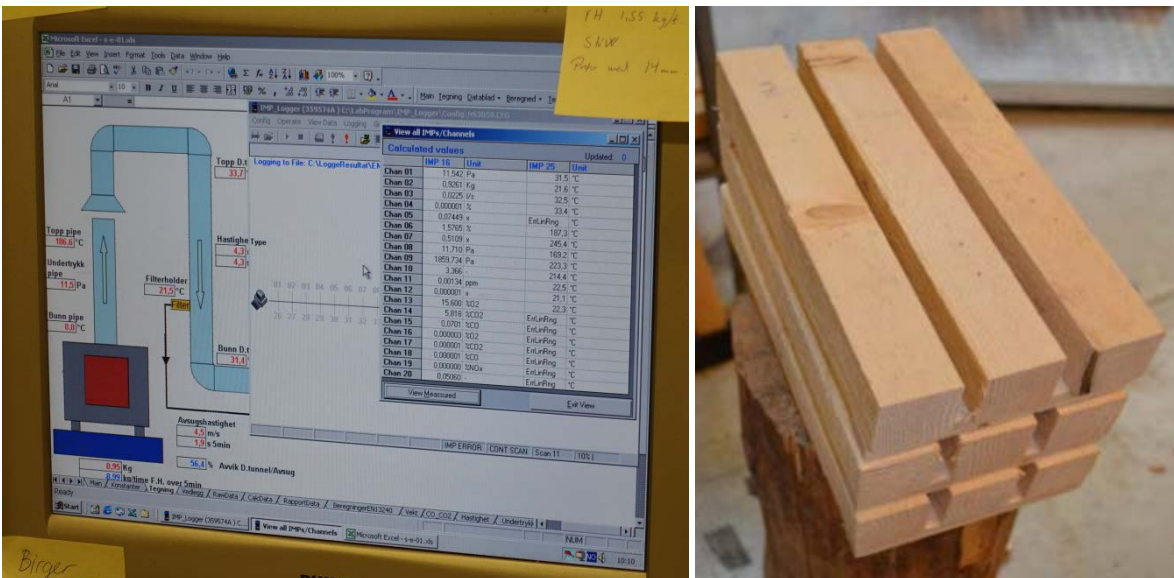

Figure 6: Experimental setup; software for data logging (top-left), spruce according to NS 3058-59 (top-right), manual handling of filters for gravimetric analyses (bottom).

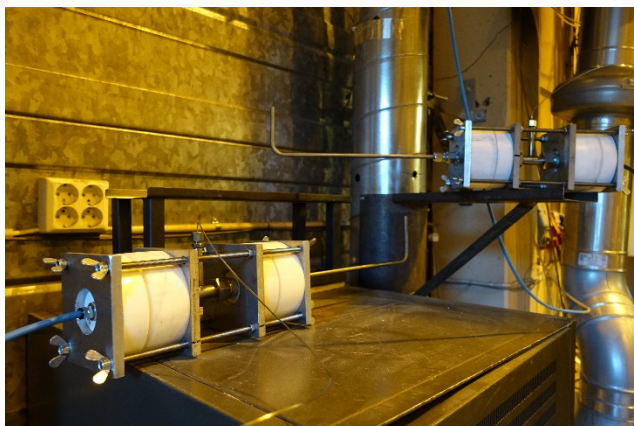

Figure 7: Double-filter holders: One with PTFE (Teflon filters - polytetrafluorethylene) and Quartz fiber filters (left), and the other with two Quartz filters (right)

The measurement of EC and OC requires a second double-filter holder with a combination of quartz fiber filters and Teflon filter, which differs from the regular Norwegian Standard requiring only one sampling line with two Glass fiber filters (one for sampling and one for backup). Quartz fiber filters enable measurements of EC/OC whose thermal processes reach temperatures up to 850 °C that Glass fiber filters would not be able to hold. However, it shall be noted that TSP weighted using a double-filter holder with quartz + PFTE or quartz + quartz will yield similar results to a combination of two Glass fiber filters. The main reason why NS 3058-59 relies on Glass fiber filters is because their unit price is much lower than the quartz fiber filters and they are much more available from commercial suppliers.

Thus, two identical double-filter holders were set up in parallel (see Figure 7), having their intake at the same height in the dilution tunnel, and each of them connected to an air pump calibrated to draw gas from the dilution tunnel at the exact same flow rate. As illustrated in Figure 8, the difference between the two double-filter holders was that one used two quartz fiber filters in a row ("1.1" for sampling and "1.2" for backup), while the other used one Teflon filter and quartz fiber filter in a row ("2.1" for sampling and "2.2" for backup). 1.1 collects both particulate EC and OC, and gaseous OC, while 2.1 collects only particulate EC and OC, leaving gaseous OC being collected on 2.2, since 2.1 in Teflon is more inert than quartz fiber to adsorption of gaseous hydrocarbons. By sending 1.1 and 2.2 for EC/OC analysis, and subtracting the OC found on 2.2 from the OC found on 1.1, accurate levels of particulate EC and OC can be determined.

In order to avoid overloading the filters with EC or OC, which would lead to excessively high uncertainties in the EC/OC analysis, recommendations issued from the BlackOut project⁷ have been followed to significantly reduce the amount of flue gas flowing through the filters. To that respect, the flue gas flow rate through the filters was reduced to 33% of the usual recommended flow (390 NI/h versus 1170 NI/h) and a probe nozzle of 5.9 mm was used instead of the regular 10 mm probe to keep the method isokinetic with regards to the dilution tunnel. This reduced by a factor 3 the amount of TSP collected on the filters, and allowed EC/OC analysis within acceptably low uncertainties.

Teflon and quartz fiber filters were systematically stored for 24 hours in a desiccator before and after the tests. The quartz fiber filters were oven baked at 800 °C for 4 hours beforehand to remove any traces of organic material to lower the uncertainties from the low quantities of EC and OC measured in the present experiments. They were stored in acid-washed petri dishes, themselves oven baked at 450 °C beforehand. After the tests, the filters 1.1 and 2.2 were sent to the University of Eastern Finland for EC and OC analysis.

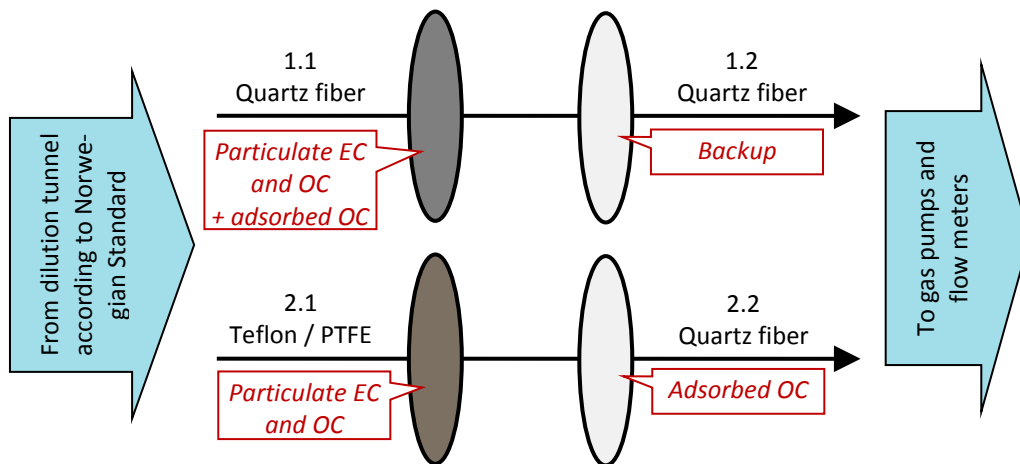

Figure 8: Schematic of the two double-filter holders used to measure particulate emissions from woodstoves allowing further analysis of EC and OC components.

To best assess experimentally the effect of aging of the woodstove, it had to be modified punctually so that measurements could be performed before and after modification. From discussions with research partners and observations from the literature, it was concluded that creating a significant artificial air leak through the door was the best solution to simulate aging of the woodstove. The modification was performed by simply removing the sealing gasket originally set all around the door of the woodstove (see Figure 9). The subsequent presence of non-preheated air at undesired locations is expected to affect dramatically the combustion conditions and eventually the resulting particulate emissions. Though this measure represents a rather extreme case, it will illustrate a worst case scenario regarding air leakage into a woodstove.



Figure 9: Woodstove door after removal of the gasket.

Two extra tests have been performed after those without gasket, to compare the emissions measurements at similar high burnrates. In this case, a new door gasket was installed and a new leakage test was performed to ensure the air-tightness of the tested woodstove was similar to the original tests. The leakage tests are performed with an applied difference of pressure of 25 Pa and with the main regulator closed. Results of the leakage tests are shown in Table 1. Note that a leakage test shall never provide zero at 25 Pa for safety reasons to ensure that a minimum flow of air passes through the air inlet when the air regulator is closed and avoid pressure build-up.

Table 1: Results from leakage tests (at 25 Pa) performed at key stages of the test campaign to ensure reproducibility.

Certification test	Before door gasket removal	Without door gasket	With new door gasket
10.5 m ³ air /h	12.5 m ³ air /h	51 m ³ air /h	11 m ³ air /h

3.2 TSP emissions measurements

3.2.1 Experimental results

The quantitative tests results for the TSP measurements on HF and FFDT filters are shown in Table 2.

- By "LOW", it is meant relatively low burnrate compared to the burnrate yielding nominal heat output (~5 kW according to manufacturer).
- "W/O GASKET" corresponds to the tests realized after removal of the door gasket, where relatively high burnrates were achieved.
- "W/O GASKET" and "LOW" were realized with the same settings for the air regulator (3mm opening) giving 3.16 kg dry wood /h and 1.19 kg dry wood /h, respectively.
- "LOW-NOM" represents a burnrate slightly lower than the burnrate yielding nominal heat output with a 6-mm opening of the air regulator, and is a supplementary case, closer to realistic nominal operations, for comparison with the two other tested cases.
- "HIGH" corresponds to tests realized after re-setting the door gasket and where the air regulator was set to an opening yielding a burnrate comparable to the one achieved without door gasket.

TSP weighted from FFDT filters are converted and adjusted into [g/h] and [g/kg dry wood] according to the set of equations given in NS3058-59². In Table 2, the HF results are highlighted in pink and burnrate in green. The remaining of Table 2 displays experimental parameters measured during the tests and relevant for reproducibility of the results. Note that the results of TSP measured on HF for test #30 are missing because of a singular leak in the gas pumping system, leading to unreliable results.

It shall be noted that the measured TSP emission factors can vary from one test to another (e.g., tests #26 versus #27), for the same given burnrate. This is especially seen outside of the nominal conditions. Despite all the efforts to keep the variables as similar as possible from one test to another, random events within the combustion cycle may occur, yielding different fractions of inorganic compounds or PM₁₀ for example. This is the main reason why several tests are made for each tested burnrate, resulting into a more reliable averaged TSP emission factor for each burnrate.

The analysis of results is presented in Chapter 3.2.3

3.2.2 Observations during the tests

As a first observation during the tests, after removal of the door gasket, the flames inside the woodstoves, usually located above the firewood, were also seen anchored nearby by the contour of the door, highlighting the air leaks artificially created. Such anchored flames are indicated by red arrows in Figure 10. As the excess air penetrating the combustion chamber was not controlled, the flames were particularly intense, yielding a relatively high burnrate for a 3-mm opening of the air regulator, which usually yields a low burn rate (3.16 kg dry wood /h versus 1.19 kg dry wood /h). This phenomenon results in producing a larger amount of heat than expected (10 kW versus 5.4 kW), though, over a shorter time period.

After removal of the door gasket, flames occupied a large volume of the combustion chamber, more than in usual low or nominal heat outputs, and similarly to combustion at high heat output, except for the additional flames anchored next to the door contour. This large volume occupied by the flames certainly collides with the regular secondary combustion zone usually settling above the regular fire, fed by the secondary air supply.

Table 2: Results from tests #26 to #34 carried under NS3058-59, with and without door gasket, yielding TSP (expressed as PMt, Particulate Matter Total, below) emissions factors for both HF (when applicable) and FFDT filters.

Burnrate category Test carried out acc. to NS3058-59	LOW			LOW-NOM			HIGH			W/O GASKET			
	#28	#29	Average	#26	#27	Average	#33	#34	Average	#30	#31	#32	Average
Test fuel	1.7 kg Spruce			1.7 kg Spruce			1.7 kg spruce			1.7 kg Spruce			
CO, measured average vol%	0.62	1.01	0.81	0.25	0.58	0.41	0.08	0.26	0.17	0.182	0.14	0.159	0.16
CO, measured average vol% at 13 % O2 adjusted	0.89	1.30	1.10	0.34	0.92	0.63	0.09	0.23	0.16	0.207	0.2	0.197	0.20
Heat output kW	6.05	4.72	5.39	5.89	5.44	5.67	10.01	13.28	11.65	12.23	8.17	9.8	10.07
Moisture content wet basis	17	17	17	17	17	17	16	16	16.00	17	18	18	17.67
PMt adjusted acc. to NS3058-59 (EAD) g/h	12.25	4.38	8.31	7.60	1.35	4.47	6.13	11.20	8.67	20.09	10.26	7.04	12.46
PMt adjusted acc. to NS3058-59 (EAD) g/kg dry wood	10.27	3.69	6.98	5.35	0.96	3.15	2.50	3.37	2.94	5.46	3.71	2.31	3.83
Total sampling period min	70	73	71.5	57	58	57.5	34	25	29.50	22	32	28	27.33
Total mass test fuel consumed kg dry wood	1.39	1.44	1.42	1.35	1.36	1.36	1.39	1.38	1.39	1.35	1.47	1.42	1.42
Burnrate kg dry wood /h	1.19	1.19	1.19	1.42	1.41	1.42	2.46	3.32	2.89	3.68	2.76	3.05	3.16
HF PMt mg	22.80	18.30	20.55	23.60	19.00	21.30	x	x	x	X	20.2	19.4	19.80
HF Suction volume Nm3	0.68	0.71	0.70	0.54	0.55	0.55	x	x	x	X	0.259	0.218	0.24
HF PMt mg/Nm3	33.38	25.63	29.51	43.40	34.42	38.91	x	x	x	X	77.99	88.99	83.49
Air regulator	3 mm opening			6 mm opening			34 mm opening			3 mm opening, w/o door gasket			
PMt measured on HF g/GJ	19.53	15	17.27	25.39	20.14	22.77	x	x	x	X	45.63	52.07	48.85
PMt measured on FFDT, based on EAD g/GJ	506.71	182.06	344.39	263.96	47.37	155.67	123.35	166.27	144.81	269.39	183.05	113.97	188.80



Figure 10: Pictures of test fuel burning in the woodstove burning after removal of door gasket.

Pictures of the filters after the tests have been arranged for visual comparison in Figure 11. Note that the filters from test #32 are not shown because they have not been sent to EC/OC due to a contamination after the

tests, yielding potentially unreliable results for EC and OC concentrations. All filters were exposed to a similar diluted flue gas volume flow rate and the camera settings were similar for all pictures to allow visual comparison.

The backup filters (1.2 and 2.2) look relatively pale and similar from one experiment to another. The filters 2.2 from tests #28 and #30 display a slightly darker pattern denoting a punctual leak of the Teflon filters 2.1, though this is marginal and induced added weight on the backup filters is accounted for in the TSP emissions measurements. The potential uncertainty associated to the EC and OC analysis due to the punctual leak is commented in the corresponding Chapter 3.3. The backup filter from test #33 appears corrupted by a stronger leak and its EC-OC analysis has been discussed (see Chapter 3.3, Uncertainties in EC/OC analysis).

The main filters (1.1 and 2.1) display a more striking difference between tests #26 to #29 and the tests without door gasket (#30 and #31) and the tests at high burnrate. The main filters in tests #30, #31, #33 and #34 were blackened from the soot, while the others are rather brown. This suggests a relatively higher concentration of EC for the tests performed without door gasket.

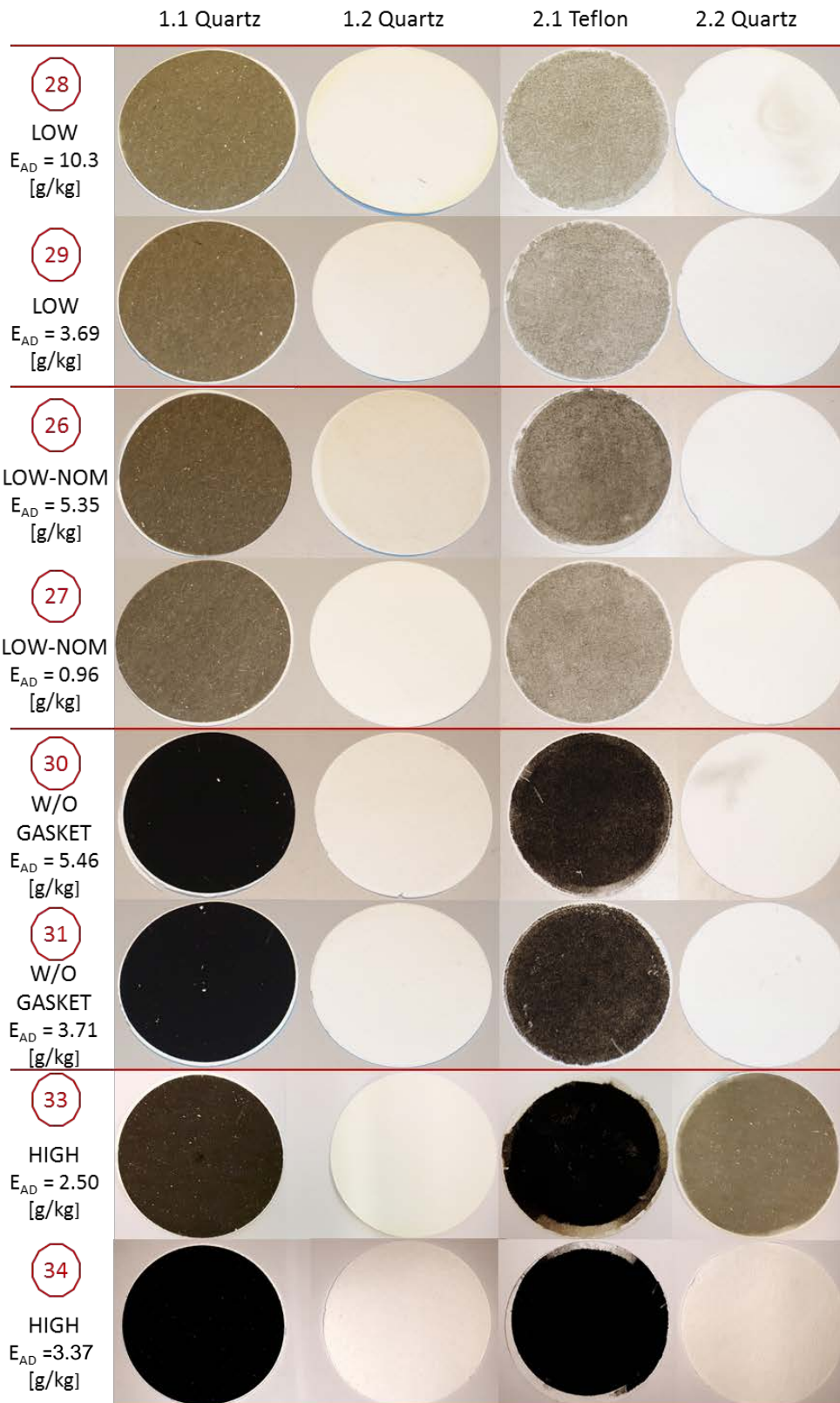

Figure 11: Filters after the tests, camera settings were similar for all pictures to allow visual comparison (except for Tests #33 and #34, taken with another camera).

3.2.3 Analysis of TSP emissions results

The present results have been compared to results of TSP emissions measurements previously performed under similar conditions (same woodstove, same test fuel, under NS3058-59 as well, but without EC/OC analysis) in order to set the results in a wider context. These aforementioned tests have been realized prior to the removal of the door gasket and are detailed in [4]. They are indicated by a "*" character in Figure 12. It shall be noted that, the FFDT results in [4] relied on TSP measurement from FFDT using Glass fibre filters, while the present results relied on TSP measurement from FFDT using quartz fiber filters instead. As explained in Chapter 3.1, quartz filters and Glass fibre filters yield similar and comparable results in terms of TSP measurements; the main difference between them is that quartz filters can stand EC/OC analysis, which involves temperatures up to 800 °C.

The average TSP measurements are shown in Figure 12 for the (FFDT) filters 4 averaged sets of data from the present results ("LOW", "LOW-NOM", "HIGH" and "W/o gasket") and 2 from [4] ("NOM*" and "HIGH*"). Previous results from nominal conditions ("NOM*") are shown here since they correspond to the best achievable (lowest) TSP emission factors. Previous results at high burnrate ("HIGH*") are shown here since their averaged burnrate is similar, though slightly above the one of the tests without gasket ("W/o gasket").

- At low burnrate ("LOW"), the FFDT filters have captured a much higher TSP level (344.4 g/GJ, equivalent to 7.0 g TSP/kg dry wood) than for any other tested burnrate. In nominal conditions ("NOM*"), the TSP emission factor is 83.9 g/GJ (equivalent to 1.7 g TSP/kg dry wood), the lowest of all, and lower than the certification result of 2.1 g TSP/kg.
- After door gasket removal, the measured TSP emission factor reaches 188.8 g/GJ (corresponds to 3.8 g TSP/kg dry wood). Though this result is about half the emission factor of the low burning rate (cf. "LOW" versus "W/o gasket" in Figure 12), it is about 29 % higher than the emissions of a corresponding burning rate ("HIGH" and "HIGH*"), and about two times the emissions that the stove was certificated for.

This shows that, despite the degradation of the combustion conditions, the presence of a large air leakage does not necessarily lead to more TSP than at equivalent opening of the air regulator (3 mm in "LOW" and "W/o gasket") without leakage. This is due to the extra air entering the combustion processes, which disrupt the fuel-rich conditions of the low burnrate and lower the total output of TSP, though the composition of the resulting TSP might differ.

However, TSP levels from FFDT filters after door gasket removal are found more than twice higher than for the nominal case ("NOM*"), and 28-30% higher than for an equivalent burnrate ("HIGH" and "HIGH*"). This shows that despite the extra air incoming into the combustion chamber due to the leakage, the combustion processes mastered in the nominal case would be altered by a strong air leakage up to yielding much higher TSP levels. Compared to equivalent high burnrate conditions, the extra air entering the combustion chamber through the leakage is colder than in regular conditions, which appear to affect the combustion processes by increasing the resulting TSP emissions factor.

It should also be noticed that all emission factor measurements are far below NS3058-59's weighted TSP emission factor limit of 10 g/kg dry wood (see Figure 12), even the averaged measurement after door gasket removal and the low burnrate case.

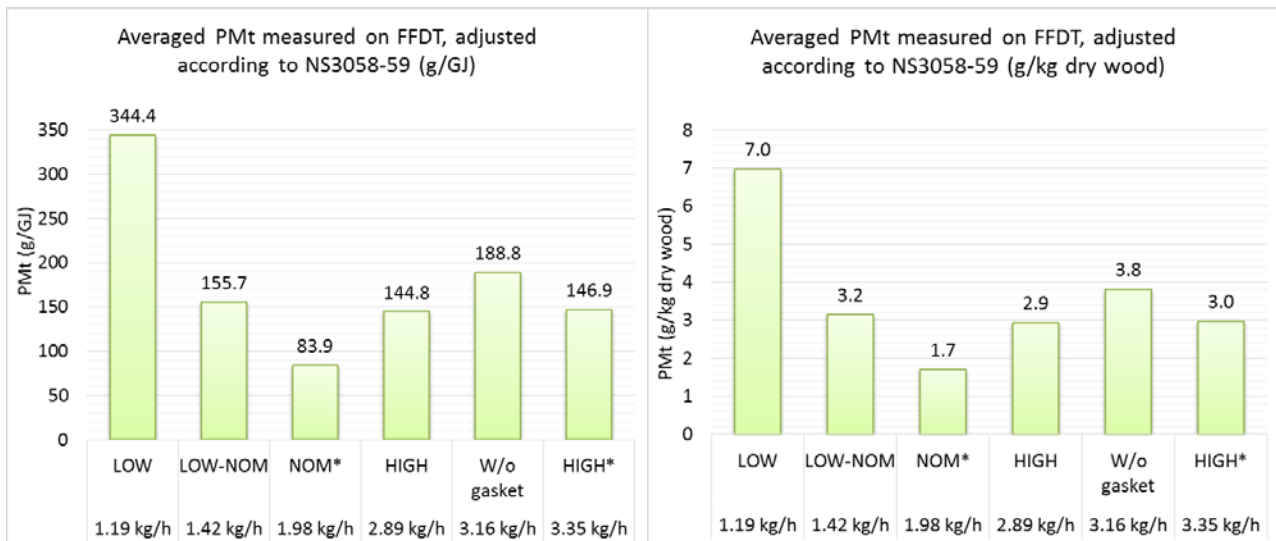

Figure 12: TSP measured on FFDT filters, using spruce as test fuel. The results are sorted from low to high burnrates with the amount of wood combusted per hour indicated for the different burnrates. Left: results in [g/GJ]; Right: results in [g/kg dry wood]. The tests marked with a star stem from previous tests on the same stove [4].

Individual TSP emissions factors are shown against the burnrate in Figure 13 and Figure 14 for the tests #26 to #32, along with previous comparable results from the current project⁴. This is to give a wider perspective of the results regarding the actual burnrate achieved during the tests. Two of the three TSP emissions factors from the FFDT filters shown in Figure 13 for the tests after door gasket removal appear higher than previous tests for similar high burnrates with spruce namely test 30 and 31. The third emission factor (around 3.05 kg dry wood/hour) from test 32 appears in the same range as previous tests.

In Figure 14, the results from TSP measurements on HF for the tests without door gasket do not seem out of the range of the other measurements of similar burnrate. However, the TSP levels after door gasket removal are systematically higher than for any tests with spruce at lower burnrate. Note that one measurement is missing (#30 in Table 2) for the HF due to a singular leakage in the pumping system.

Comparing Figure 13 and Figure 14, there is a striking difference at low burnrate, where FFDT filters seem to capture much more TSP than the HF. The differences between the two types of measurements can be explained by the condensable gases flowing through the HF without being captured, while mostly condensing on FFDT filters at lower temperatures. The HF is kept above 70 °C to avoid adsorbing condensable gases. However, the FFDT filters are operated through the dilution tunnel under 35 °C and would allow adsorption of part of the condensable gases and/or eventually capture condensed vapours onto existing particles or particles formed by nucleation of condensable gases.

Following the reasoning above, for the given 3-mm opening of the air regulator, the condensable gases seem to account for a large share of the TSP found on FFDT filters for the woodstove with door gasket ("LOW"), while being a minor part of the TSP found for the woodstove without door gasket ("W/o gasket").

The current results for TSP was compared with the Jøtul F3 stove tested in the previous BlackOut project. As can be seen in Figure 15, the current stove is more optimized for low burn rates in terms of particle emissions.

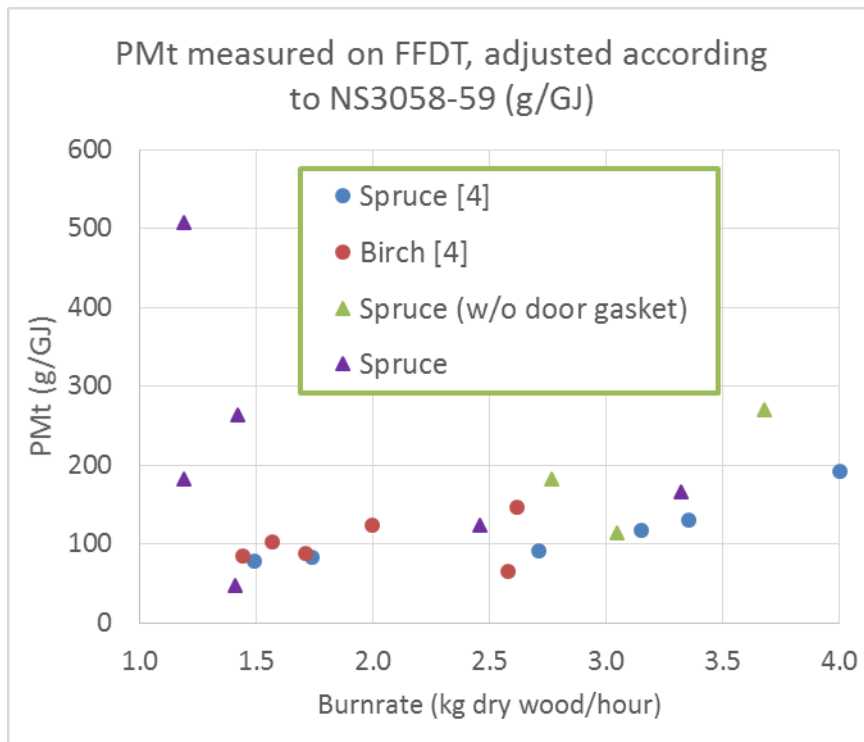

Figure 13: TSP measured on FFDT filters with a large group of tests performed prior to removing the door gasket, and after removing the door gasket (in green). All tests were performed under NS3058-59 conditions. The measurements detailed in this report are marked as triangles.

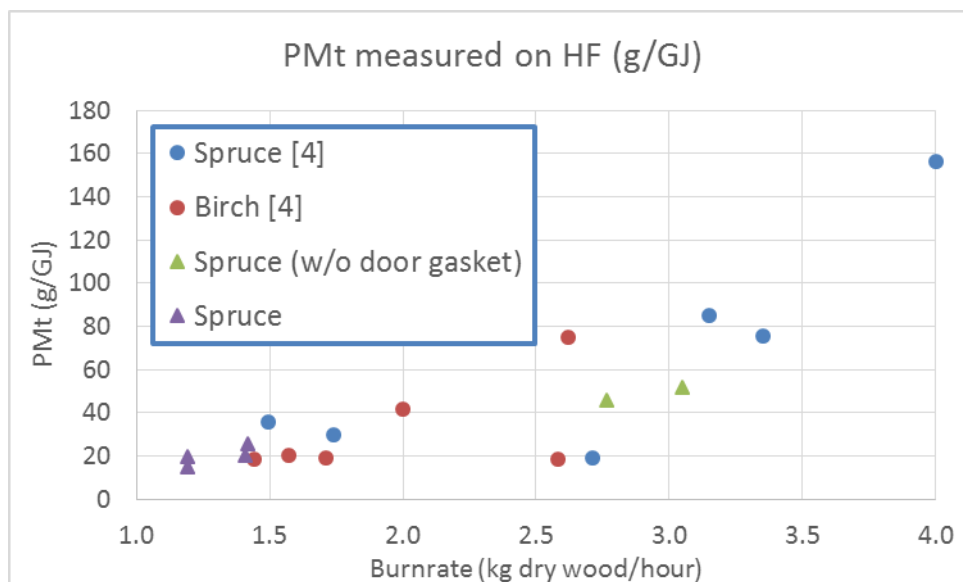

Figure 14: TSP measured on HF with a large group of tests performed prior to removing the door gasket, and after removing the door gasket (in green). All tests were performed under NS3058-59 conditions.

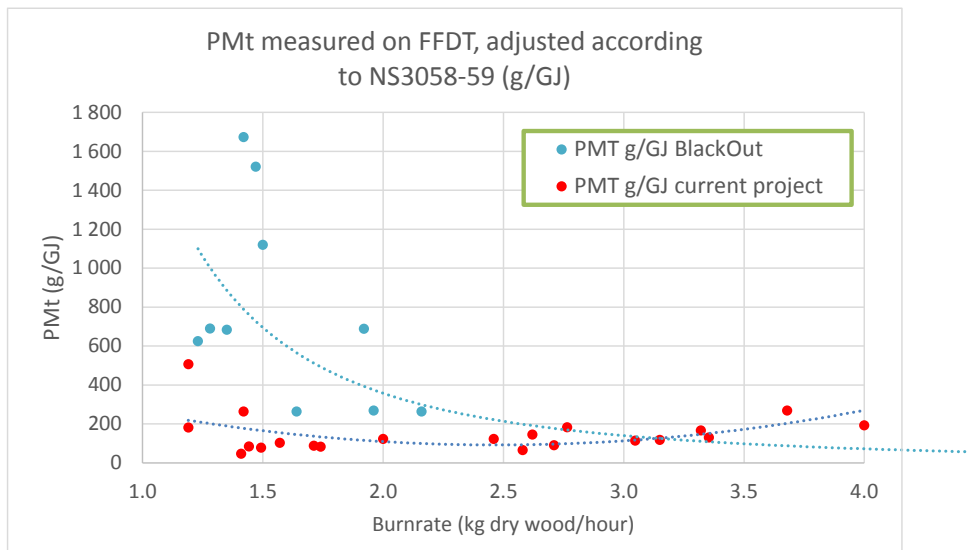

Figure 15: Comparison of PMt emissions in g/GJ, previous project BlackOut vs current project. The stove used in BlackOut was a Jøtul F3 with modern technology. In the current project, measurements were performed at a stove with even better technology and more optimized towards low emissions at low loads.

3.3 EC/OC analysis

The method for analyzing EC and OC is explicitly described in the BlackOut project report⁷. The University of Eastern Finland used a strictly similar method in the present project. OC and EC were originally measured on filter samples in $[\mu\text{g}/\text{cm}^2]$, and were converted to $[\text{g}/\text{kg dry wood}]$ following the methods given in the Norwegian Standard NS3058-59^{1,2} to be able to compare all the experimental results on the same basis.

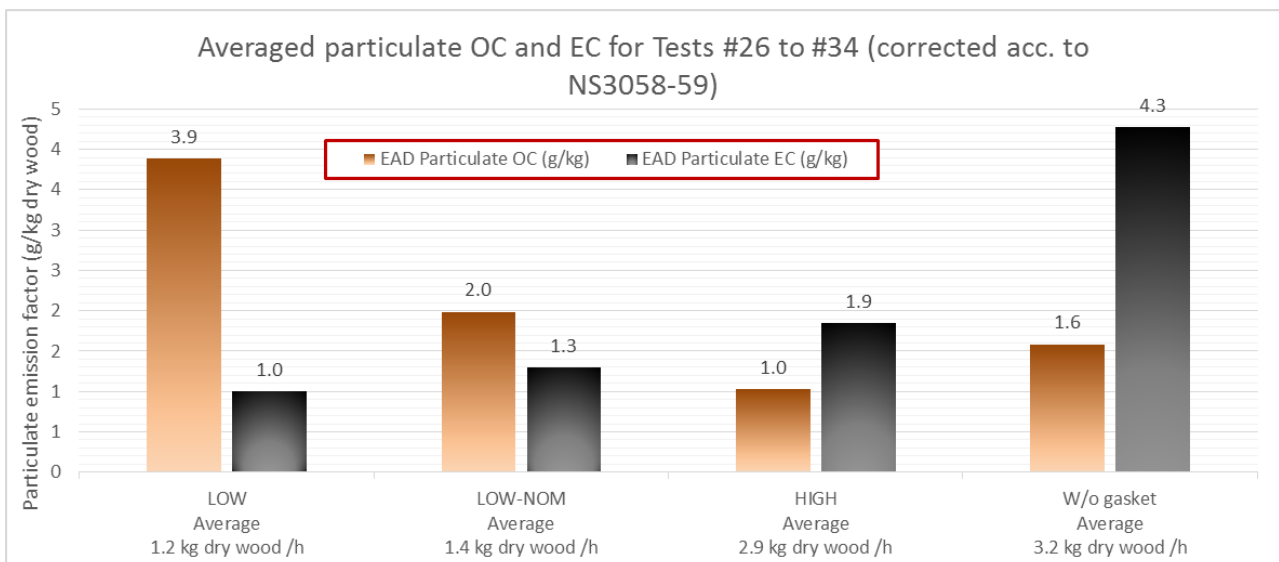

Figure 16: Averaged results from EC and OC analysis from tests #26 to #34, including those performed w/o door gasket (#30 and #31). Samples were taken at 1/4 of radius on filters.

As shown in Figure 16:

- At low burnrate ("LOW"), the OC levels are relatively high and clearly predominant over EC.

- Close to nominal conditions ("LOW-NOM"), the EC levels have increased compared to "LOW" burnrate, and the OC levels have significantly decreased on average, reducing the predominance of OC over EC.
- After removing the door gasket, which yielded higher burnrate, EC levels are ca. 2-4 times higher than at other tested burnrates, and clearly predominant over OC levels.
- Compared to a relatively similar burnrate ("HIGH"), OC levels are found 60% higher and EC levels 2.3 times higher after removing the door gasket.
- At high measured burnrates ("HIGH" and "W/o gasket"), EC levels are substantially higher than for lower burnrates, but OC levels are lower than the EC levels.

Results without door gasket emphasize the potential deterioration of the combustion conditions due to cold air entering the combustion chamber at the improper place, through the contour of the door and partially quenching the chemical processes involved in the combustion.

As highlighted in Chapter 2, it is expected to find higher OC levels at low burnrates compared to nominal conditions, due to organic vapors originating from incomplete combustion or from, for instance, low-temperature wood pyrolysis releasing organic material, which condenses quickly after emission. It was also seen by comparing the results from HF and FFDT filters than at low burnrates, a large share of the TSP captured on FFDT might come from condensable gases.

It is also highlighted in Chapter 2 that EC may burn out in a post flame zone if oxygen is present (as in the secondary combustion zone) and such process is enhanced at higher temperature. This fact alone suggests that, for instance, cold air leaking into the combustion chamber of non-maintained modern woodstove would alter the efficiency of the secondary combustion zone and eventually yield higher EC levels.

The high EC levels found in the present results ("HIGH" and "W/o gasket") might as well be explained by the very intense combustion taking place at high burnrates. Flames might occupy such a large share of the combustion chamber volume that the phenomenon may eliminate the benefits of the secondary combustion zone, thus yielding higher EC levels.

The latter assumption is likely to justify the EC levels for the high burnrate ("HIGH"), while a combination of the two aforementioned assumptions would justify the high levels found after door gasket removal.

Referring to the results from EC/OC analysis from the BlackOut Project⁷, EC and OC levels were found lower at high burnrate than at nominal and low burnrates for both old- and new technology tested woodstoves. Nevertheless, in absolute value, OC levels were essentially higher in the BlackOut project than the present results for all burnrates, while EC levels were comparable at low burnrates but lower at higher burnrates. EC/OC distribution with the burnrate is very much inherent to the design of the combustion chamber itself and comparison between woodstoves cannot be done straightforward.

Uncertainties in EC/OC analysis

The following is adapted from the analysis report³¹ from the University of Eastern Finland and from direct communications. 16 samples collected on quartz fiber filters were analyzed with an OC-EC Aerosol Analyzer manufactured by Sunset Laboratories Inc. (model 4L). The NIOSH protocol was used in the analyses, whose detailed description of the operating method can be found on the manufacturer's website³².

All the filters (8 filters "1.1" and 6 filters "2.2") were analyzed at least once. A 1.5 cm² punch (see Figure 17) was taken approximately ¼ of the radius from the center of each filter. The 8 filters "1.1" were analyzed a

³¹ *EC/OC Analysis of Particulate Emission Filters*, H. Lamberg, University of Eastern Finland, Report, 6.11.2015

³² *Methodology*, Sunset Laboratories Inc. <http://www.sunlab.com/about-us/methodology/> (visited 09.11.2015)

second time, taking a sample at $\frac{3}{4}$ of the radius, to check for homogeneity in the distribution of EC and OC and repeatability of the results. The extra measurements yielded similar results to the original ones at $\frac{1}{4}$ of the radius, where differences are sufficiently low to be within the uncertainties range of the analysis process itself. This proves that TSP, and especially EC and OC were equally distributed on the filters in the present tests.

From a technical point of view, the results seem correct for most of the filters. OC values are well below the limits given by manufacturer's recommendations³². Despite the flow rate reduction by a factor 3 of the flue gas flowing through the filters during the tests, EC values are rather high in the samples from high burnrate (slightly above the limit of the manufacturer's recommendation). For these two filters (#31 and #32), this gives an increased uncertainty in the laser correction (correction of the amount of EC forming during the OC analysis).

Some traces (visible and measured) of particulate matter could also be seen on two backup (2.2) filters, as indicated by the shadow-like pattern in Figure 17. This indicates a singular leakage of the main filter (2.1). Sample punches in the impacted filters were taken from a visibly white area to avoid any added uncertainties. Backup filters are usually all white (no EC) or they may display a very light color, evenly distributed on the filter. Since the analyzed EC on the backup filters was very low, compared to the total EC found on the corresponding main filters 1.1, it was concluded that the leakage did not have any practical effect on the reliability of the EC analysis. The impact on the OC analysis obtained through the backup filter was also estimated to be insignificant, especially due to the comparison with the other backup filters which displayed similar OC levels than those with traces of leaks.

In the case of backup filter (2.2) from test #33, the sought OC concentration could not be directly exploited due to the strong leak of TSP (see Figure 11). However, since this value is only a correction to the main OC concentration measured on filter 1.1, and since the OC concentrations found on all other analyzed 2.2 filters were very similar to each other and equal to, on average 11 % of the main OC concentration, the aforementioned correction was applied for the final OC concentration of test #33.

In conclusion, the analysis of EC and OC concentrations showed that all tests (#26- #34) were found to be of sufficient quality to be included in the results.



Figure 17: Example of sample for EC/OC analysis taken from one quartz filter with a trace of leakage.

4 Conclusions and recommendations

The first part of the report focuses on the literature findings about the most significant effects of maintenance on TSP emissions. The second part of the report focuses on a comparison of TSP, EC and OC concentrations from experimental tests realized on an artificially aged modern woodstoves, before and after alteration.

Literature review on influence of maintenance on particulate emissions

- Recommended maintenance of any residential woodstove^{7,8,15,16,17,18} often refers to a well-defined set of actions onto the whole wood-based heating system, namely:
 - Removing soot from the fireplace glass, as it blocks direct radiation from the flame.
 - Empty the ashes, though not too often. The ashes insulate and protects the bottom and the floor underneath the fire.
 - Inspect and replace if necessary the door gasket and adjust air-tightness of the door.
 - Annual maintenance: remove baffle plate and burn plates to ensure they are in good shape. Worn internal parts shall be replaced.
 - Contact a professional regularly to sweep the chimney (minimum every four years).
- These actions are mostly linked to the ways in which particulate matter (TSP) are emitted from wood combustion processes. Any alterations of the original design of the combustion chamber necessarily contribute to affect the mechanisms leading to the creation or destruction of the components of the emitted TSP.
- Operating a woodstove at very high temperatures will significantly contribute to the deterioration of the woodstove.
- The emission levels of the most recent woodstoves have become so low that they can only be kept at so low levels if the appliance remains like new and if the user strictly operates it as described by the manufacturer. Any accumulating soot over time, or air leakages for instance, will certainly alter the combustion conditions compared to the original design, and in turns, lead to higher TSP levels.

Experimental investigation on influence of air leakage on particulate emissions

To study the influence of maintenance on TSP, EC and OC emissions from modern woodstoves with a reduced amount of experimental tests, measurements were carried out on an artificially aged modern woodstove. The method consisted in removing the door gasket and performing tests before and after alteration, on the same woodstove following the Norwegian Standard NS3058-59. Though this measure represents a rather extreme case, it illustrates a worst-case scenario regarding air leakage into a woodstove.

- Removing the door gasket represents an extreme case of air leakage. It leads to high burnrates yielding very high local temperatures above the manufacturer's recommendations and this may lead to further deterioration of the appliance.
- Despite the degradation of the combustion conditions, the presence of a large leakage does not necessarily lead to more TSP than at equivalent opening of the air regulator (3 mm in "LOW" and "W/o gasket") without leakage. This is due to the extra air entering the combustion processes, which disrupt the fuel-rich conditions of the low burnrate and lower the total output of TSP, though the composition of the resulting TSP might differ.
- However, TSP levels from FFDT filters after door gasket removal are more than twice higher than for the nominal case ("NOM*"), and 28-30% higher than for an equivalent burnrate ("HIGH" and "HIGH*"). This shows that despite the extra air incoming into the combustion chamber due to the

leakage, the combustion processes mastered in the nominal case and regular high burnrate would be altered by a strong air leakage up to yielding much higher TSP levels.

- At low burnrates ("LOW"), the OC emissions factors are relatively high and clearly predominant over EC. Close to nominal burnrate ("LOW-NOM"), the EC levels have increased compared to "LOW" burnrate, and the OC levels have significantly decreased on average, reducing the predominance of OC over EC. After removing the door gasket (yielding higher burnrate), EC levels are approximately 2-4 times higher than at other tested burnrates, and clearly predominant over OC levels. This emphasizes the potential deterioration of the combustion conditions due to cold air entering the combustion chamber at the improper place, through the contour of the door, and partially quenching the chemical processes involved in the combustion.
- The high EC levels found in the present results ("HIGH" and "W/o gasket") might as well be explained by the very intense combustion taking place at high burnrates. Flames might occupy such a large share of the combustion chamber volume that the phenomenon may eliminate the benefits of the secondary combustion zone, thus yielding higher EC levels.
- EC/OC distribution with the burnrate is very much inherent to the design of the combustion chamber itself and comparison between woodstoves might not be straightforward.

From the tests carried out within this project, TSP measurements have shown an increase after removing the seal gasket from the woodstove door, compared to similar burnrate conditions with the door gasket: twice more TSP than at nominal conditions, and 28-30% higher than at equivalent burnrate. EC emissions factors are also found four times higher than at nominal conditions. These two results indicate that a large leakage of non-preheated air into the combustion chamber shall be avoided in order not to increase TSP and EC emissions.

Beyond that conclusion, it shall be noticed that these emission comparisons are made with reference to the amount of TSP or EC emitted for a given mass of firewood. Without door gasket, the combustion conditions were hardly controllable, systematically yielding a relatively high burn rate. Seen by the user, these conditions produce a larger amount of heat than expected (10 kW versus 5-6 kW) in relatively short time, leading to two issues:

- The user might require to actually use more firewood than expected to keep a sufficiently high heating effect over a longer time period, which incontestably lead to higher total TSP emissions than with a well-maintained woodstove.
- Firing the woodstove at heat output and temperature higher than the manufacturer's recommendations (nominal 5 kW and max 9 kW in this case) greatly contributes to a faster deterioration of the appliance.

Recommendations

In the Norwegian context, beyond the actions already taken by law by professionals (i.e. chimney sweeps and control of appliances) and based on the results detailed in the present report, users of residential woodstoves are strongly encouraged to take the following actions, for their own safety and for the sake of the public health and environment.

- Do not fire your appliances at much higher burnrate than its nominal conditions for more than a few minutes, since this would contribute to deteriorate your appliance and may generate higher EC emissions to the atmosphere than expected.
- Inspect and replace if necessary the door gasket and adjust air-tightness of the door. The original door gasket on modern woodstoves is supposed to operate properly for at least 5 years. There are many ways to inspect the door gasket and air-tightness of the door:
 - Check the door gasket with your hands, it should be possible to compress it, all around the door. If it feels stiff or flat, it is most likely time to change the gasket.

- Place a piece of paper between the door and the woodstoves, close the door and try to remove the piece of paper. If the paper comes out easily, the door tightness should be adjusted. Repeat the test at various locations around the door.
- Run a lighter alongside the contour of the door when the door is closed. If you see the flame being sucked in towards the door due to the draught, it indicates an air leak.
- When firing the woodstove, check if some flames are anchored to the door contour, such as illustrated in Figure 10. This would indicate a significant air leakage.
- Use the opportunity of having a professional chimney sweep inspecting your appliance to request a full cleaning of the inside of the woodstove. Professional chimney sweeps will visit you at least once every four years for law.
- If not performed by a professional, cleaning the inside of a woodstove includes removing the soot alongside the walls, removing the baffles plates and burn plates to ensure they are in a good shape. Worn internal parts shall be replaced.
- Remove any soot from the woodstove door glass, as it blocks direct radiation from the flame.
- Empty the ashes, though not too often. The ashes insulate and protect the bottom and the floor underneath the fire.

Other recommendations

Potential introduction of air-tightness guarantee

Regarding the potential need to introduce a guarantee of air-tightness on purchase of new woodstoves, it is mentioned in the report that one could expect a new woodstove to operate properly, without need for heavy maintenance, for the first five years. Introducing an official guarantee those first five years might be of interest to ensure that the TSP (and EC) emissions from new woodstoves remain close to their original values. However, the way the user operates the woodstove has a strong influence onto the state of the appliance, especially when firing at high burnrates, as shown in the present report. This shall be kept in mind when introducing a duration for the potential guarantee.

Relationship between TSP, PM₁₀, PM_{2.5}, OC and EC levels

Regarding the establishment of a relationship between TSP, PM₁₀, PM_{2.5}, OC and EC levels, beyond the trends mentioned in the report, quantified correlations cannot be established. If there were a clear correlation appearing from the present data, it would certainly be inherent to the selected woodstove, with no practical generalisation.

EC/OC measurement method

The authors recommend to use the method described in the present work to avoid overloading the filters with EC or OC, which would lead to excessively high uncertainties in the EC/OC analysis. It consists in significantly reducing the amount of flue gas flowing through the filters. To that respect, the flue gas flow rate through the filters was reduced to 33% of the usual recommended flow (390 NI/h versus 1170 NI/h) and a probe nozzle of 5.9 mm was used instead of the regular 10 mm probe to keep the method iso-kinetic with regards to the dilution tunnel. This reduced by a factor 3 the amount of TSP collected on the filters, and allowed EC/OC analysis within acceptably low uncertainties.

The tests samples from the present work have been conserved in good conditions for potential future analysis.



Technology for a better society

www.sintef.no