

**”RFID, Wireless Technologies and Sensors for Building Industry, Intelligent Buildings and Smart Houses”**

**Radisson SAS Scandinavia Hotel, Oslo, 12 March 2008**



# **RFID and Wireless Sensors for Building Industry**



**O. Vermesan, M. Viktil**  
**SINTEF**



# Outline

- European Technology Platforms
- Smart House-ICT and Automation
- ICT in Construction Industry
- RFID and Sensors on Construction Sites
- Cases
- Potential in Construction Sector
- Challenges

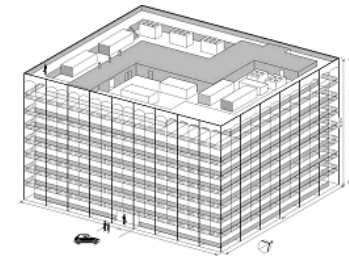

# European Technology Platforms

- SmartGrids-European Technology Platform for the Electricity Networks of the Future
- ESTEP-European Steel Technology Platform
- SusChem-European Technology Platform for Sustainable Chemistry
- ECTP-European Construction Technology Platform
- eMobility-Mobile and Wireless Communications Technology Platform



# The Vision for the Future

- Information, electronics and communication embedded in building components and equipments (including sensors and actuators)
- Building components are active, communicating and interoperating within a system that provides advanced services related to:
  - Energy savings
  - Comfort, health and safety
  - Security
  - Elderly and disabled people
  - Multimedia, entertainment and monitoring
  - IP and wireless communication
  - Exploitation, facilities and maintenance management



# The SMARTGRIDS Vision

- Flexible: customers needs
- Accessible: to all network users, high efficiency distribution with zero or low CO2 emissions
- Reliable: quality of supply and resilient to hazards and uncertainties
- Economic: best value via innovation, efficient energy management, competition and regulation



Source: SmartGrids-European Technology Platform for the Electricity Networks of the Future

# New Grid Energy Distribution



Source: SmartGrids-European Technology Platform for the Electricity Networks of the Future

# New Grid Energy Distribution

- Today: From producer to consumer
- Future: Operation of system will be shared between central and distributed generators. Control of distributed generators could be aggregated to form microgrids or ‘virtual’ power plants to facilitate their integration both in the physical system and in the market.

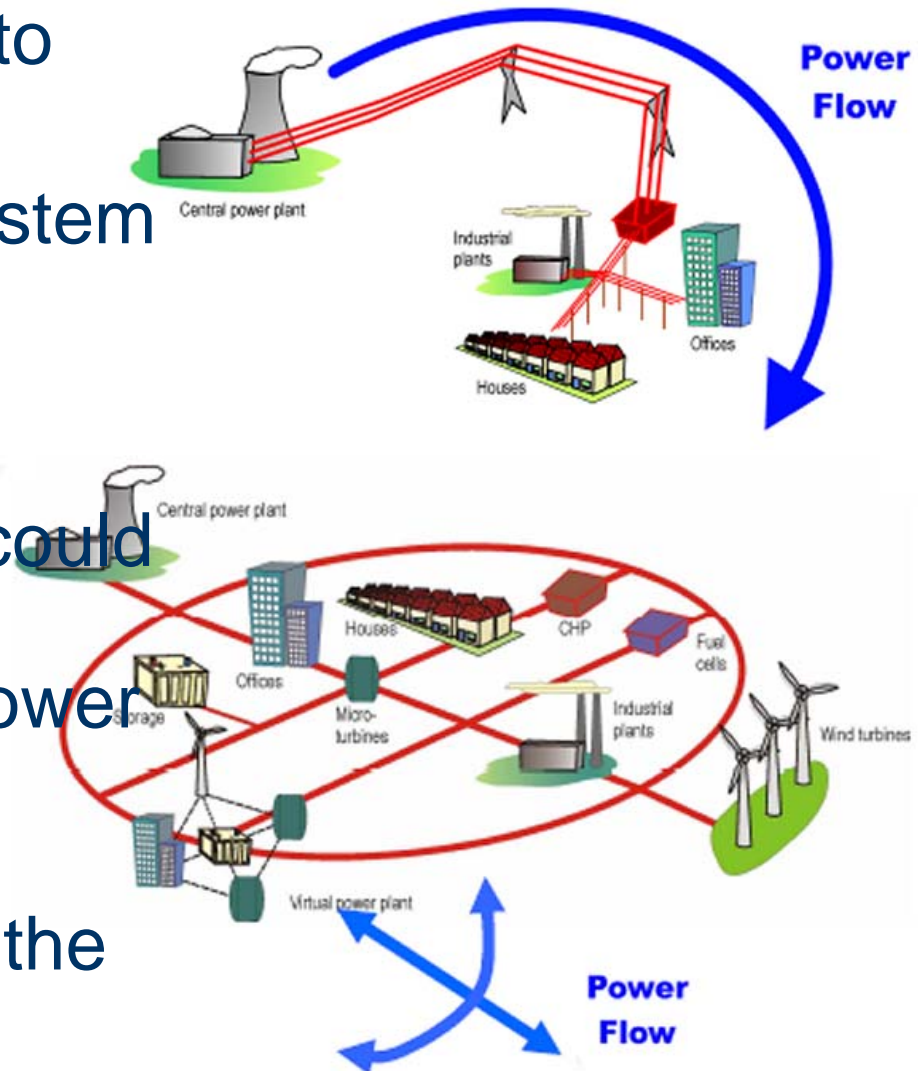

Source: SmartGrids-European Technology Platform for the Electricity Networks of the Future

# Steel and the Construction Sector

- Construction is the biggest market for steel - the share of steel consumed in the European construction sector is around 30% of total consumption
- ICT monitoring of steel structures and novel technologies and strategies

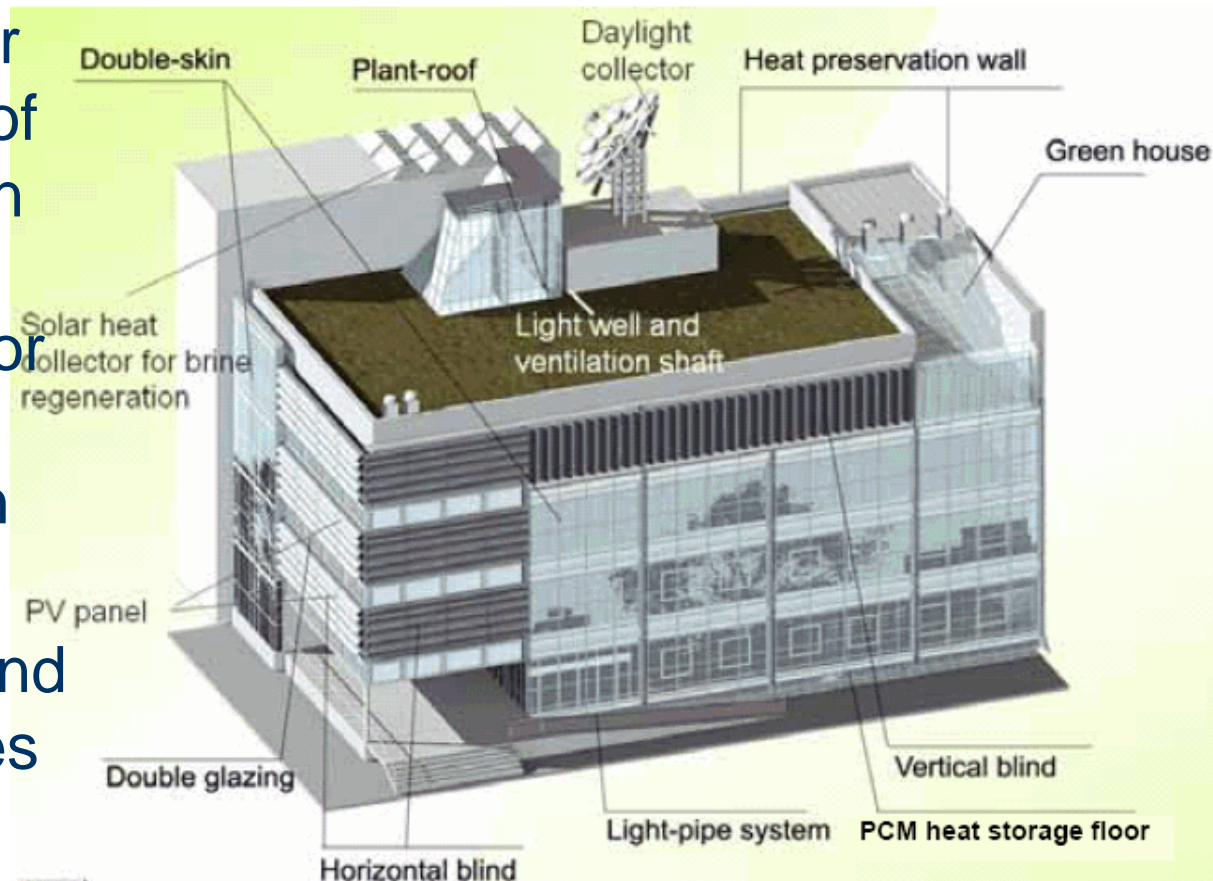

Source: ESTEP-European Steel Technology Platform



# The Energy Generating Home

## Technologies

- Wind turbine
- Solar panels
- Fuel cells
- Heat pumps, exchangers
- Energy recovery transformation
- LED lighting
- Networked Sensors
- Automation control
- Feeding into grid

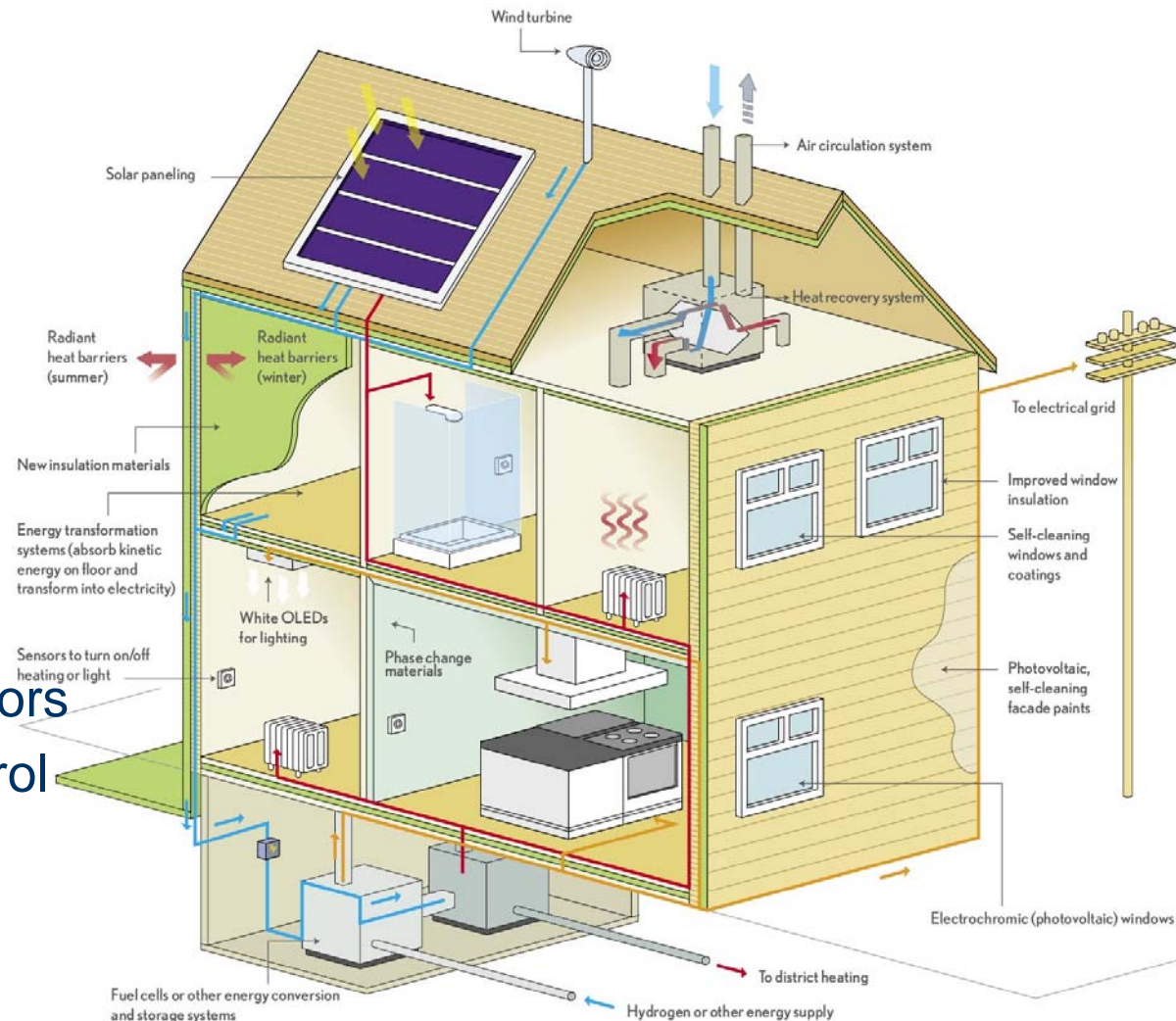

Source: SusChem-European Technology Platform for Sustainable Chemistry

# Smart House Energy and Resources

- Thermal insulation
- Fuel cells/ batteries
- Efficient domestic appliances
- Phase changing materials
- Efficient lighting
- Photovoltaics
- Water and waste management
- Automation
- ICT



Source: SusChem-European Technology Platform for Sustainable Chemistry

# Smart and Intelligent Features

- Awareness enhancing technologies
- Security
- Domotics
- Smart materials
- Remote shopping
- Wireless sensors
- RFID and ubiquitous environments
- Multimedia
- IP communication

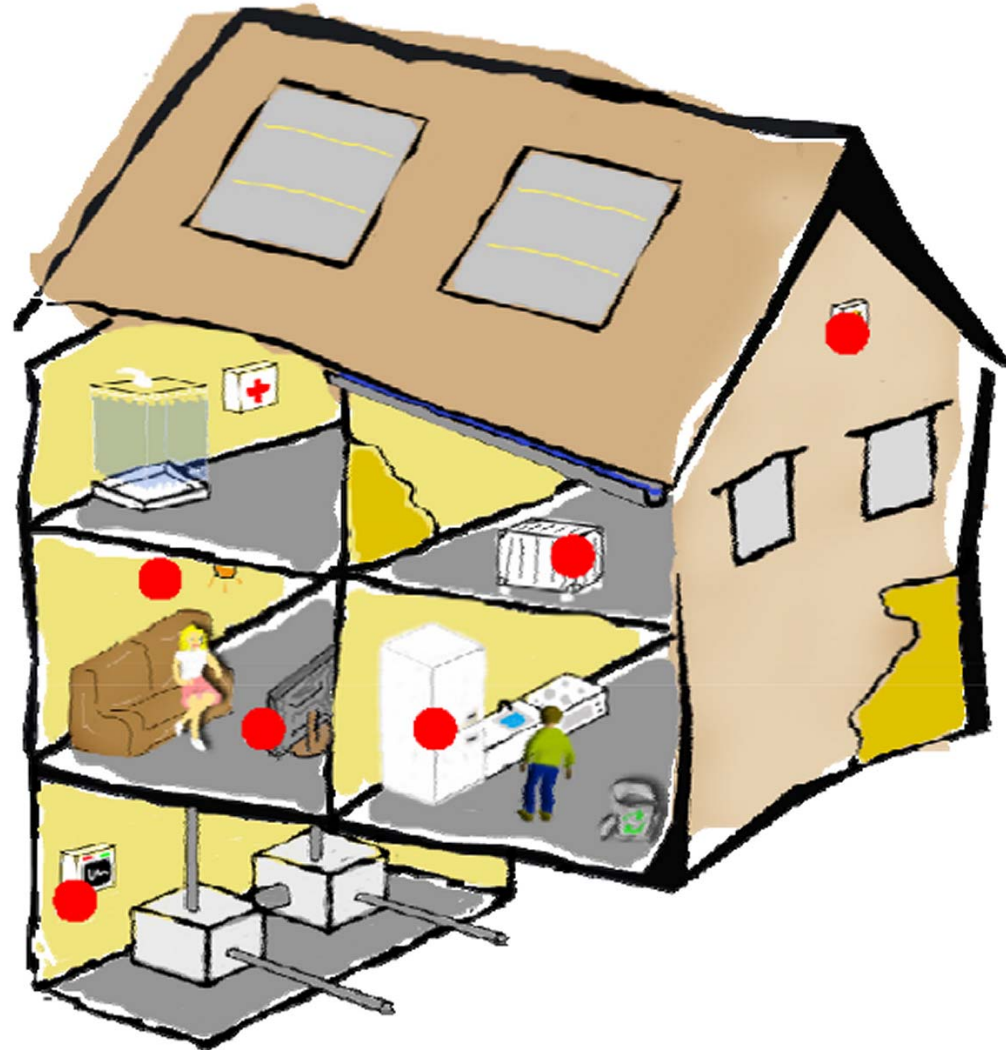

Source: SusChem-European Technology Platform for Sustainable Chemistry

# Smart House Health and Comfort

- Self cleaning surfaces
- Remote diagnostics - monitoring
- Sound insulation
- Sustainable consumer products
- Personalized nutrition
- Air quality
- Wireless sensors
- RFID
- e-health options for diagnosis and sensing of body functions



Source: SusChem-European Technology Platform for Sustainable Chemistry

# ECTP-ICT and Automation

- ‘Intelligent products’, capable of communicating location, orientation and condition.
- RFID tag incorporated in any product.
- MEMs and miniature intelligent networked wireless sensors and actuators;
- Dispersed in large numbers in the built environment to monitor the condition of structures.



Source: ECTP-European Construction Technology Platform

# ECTP-ICT and Automation

- Multidisciplinary research, bridging the gap between mobile and wireless communications and other industries.

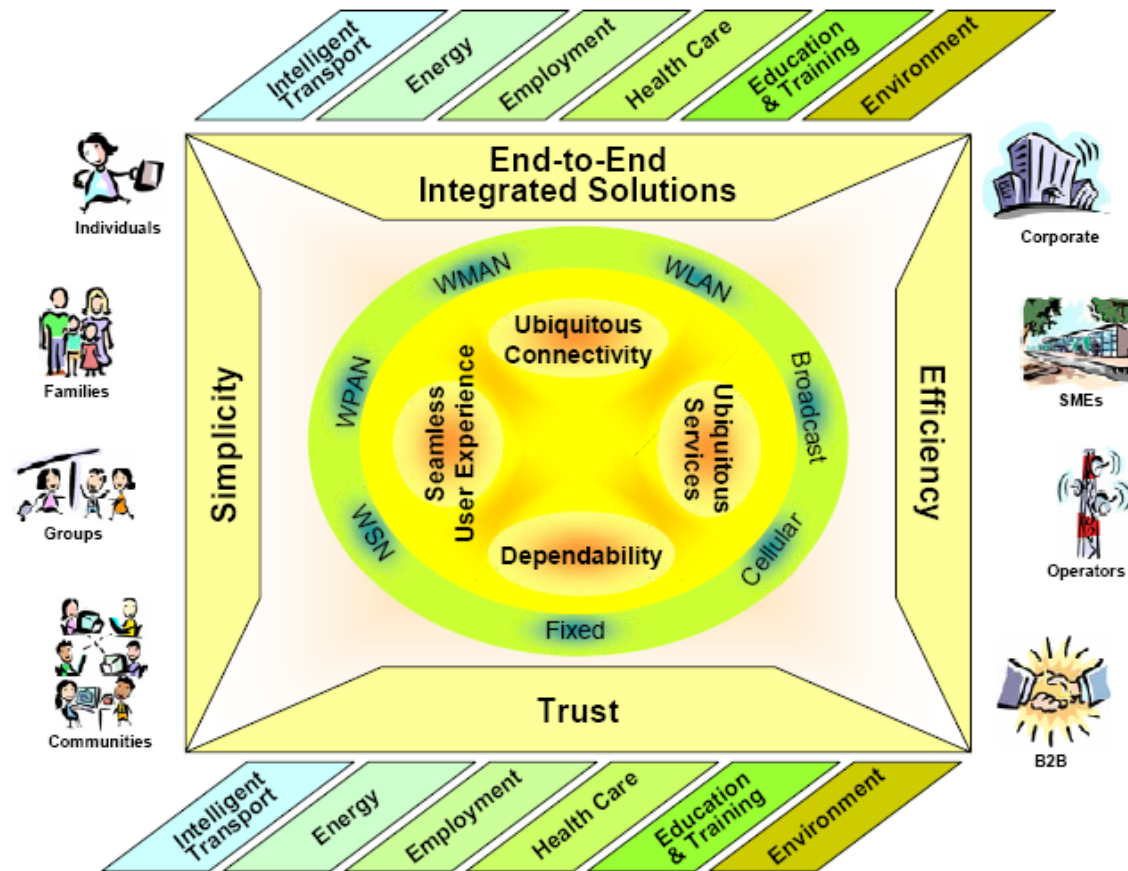

Source: mobility-Mobile and Wireless Communications Technology Platform



# ICT in Construction Industry

- ICT tools that address the specific needs of the Construction Sector:
  - All mobile sites are effectively connected to corporate information networks;
  - High technology construction integrates IT services, wireless communication, sensors, actuators and diagnostic tools.
  - Maintenance needs are no longer controlled manually, but are instead offered by the system through convenient user interfaces.
  - Information is shared by the Construction Sector throughout the whole life-cycle of buildings and the built environment by means of integrated information systems using RFID and sensors and encompassing all processes.

# ICT in Construction Industry



## ■ Research Areas

- Development of industry standards and effective de-facto standards for data exchange, object definitions, and integrated model servers;
- ICT tools for the efficient connection of all those involved in mobile sites to corporate information networks, and to develop ubiquitous (RFID/wireless sensors) access to health and safety knowledge;
- Intelligent equipment and materials for construction based on mechanisation, automation or robotization;
- ICT, RFID, sensor technologies and micro-mechanics to monitor and control the built facilities and their environment, including RFID, wireless communications and new communication channels between the underground and the surface;



# ICT in Construction Industry



## ■ Research Areas

- Development of new visualization, virtual reality and communication tools, based on advanced ICT systems and using shared integrated data models, enabling a 'value' assessment of the built environment asset to take place in many dimensions:

- Energy consumption,
- visual impact,
- functionality,
- internal environmental
- quality,
- safety,
- security,
- flexibility,
- operating costs
- expected lifetime,

**Regular RFID  
Grid within  
flooring**



**Source: Infineon**

# ICT in Construction Industry



## ■ Research Areas

- Adoption of radically-advanced construction concepts such as integrated and intelligent agent systems, programmable nano-materials and nano-constructors, bio-mimetic materials, structures and facility systems;
- Construction will be opened to a wider range of potential workers by:
  - the development of new manufacturing systems and automation;
  - rationalization of construction processes, with off-site assembly of large, fully-fitted components;
  - mechanization of site activities aided by new automation and guidance technologies.

# Network Topology

## ■ Intelligent Buildings

- Integration on the sub-networks of the system.
- Sub-nets are the local operating networks that connect to the backbone on the system.
- Local sub-net are wired/wireless (RFID, ZigBee, WiFi, Bluetooth, etc.)
- Fire alarm sensors, temperature monitoring, PIR, sounder and fire detector, emergency lighting system with white LED.

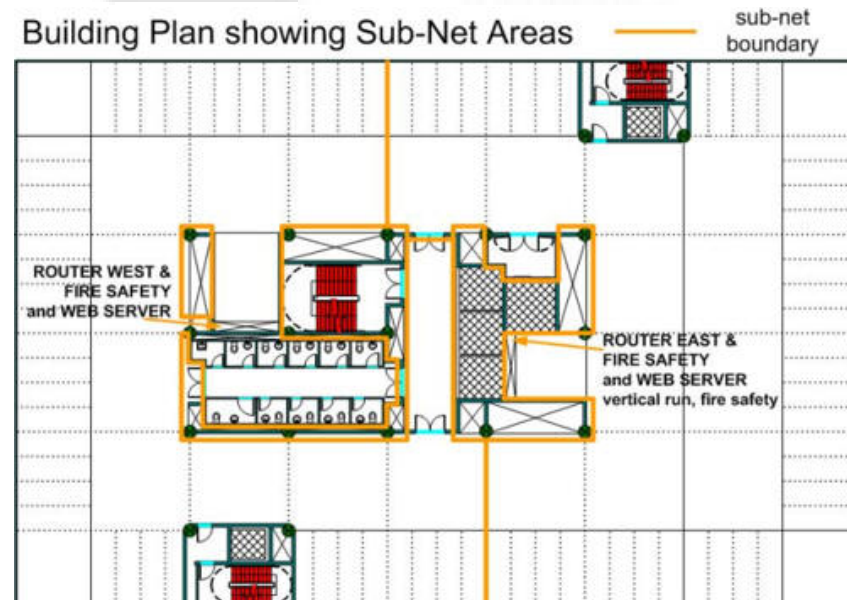
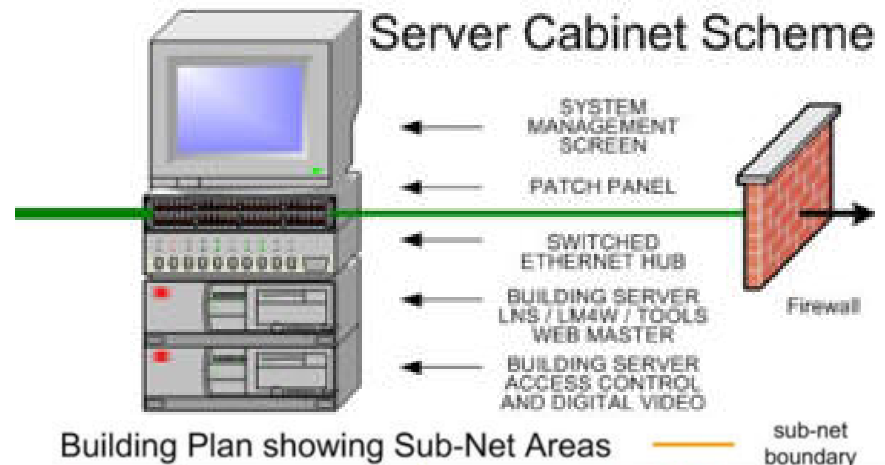

Source: LonMark International

# Future Network Topology

## Supporting very large number and variety of devices

- Wireless communicators:
  - Cell phones, PDA's, pagers, etc.
- Interactive "smart" sensors:
  - Health monitors, environmental sensors, etc.
- RFID tags

## Enabling "true" mobile computing

- Complete range of service (Internet, TV, VoIP, etc.)
- Self-configuring
- Seamless roaming
- On demand remote storage

Data, voice and multimedia will be carried over a heterogeneous physical network running IP

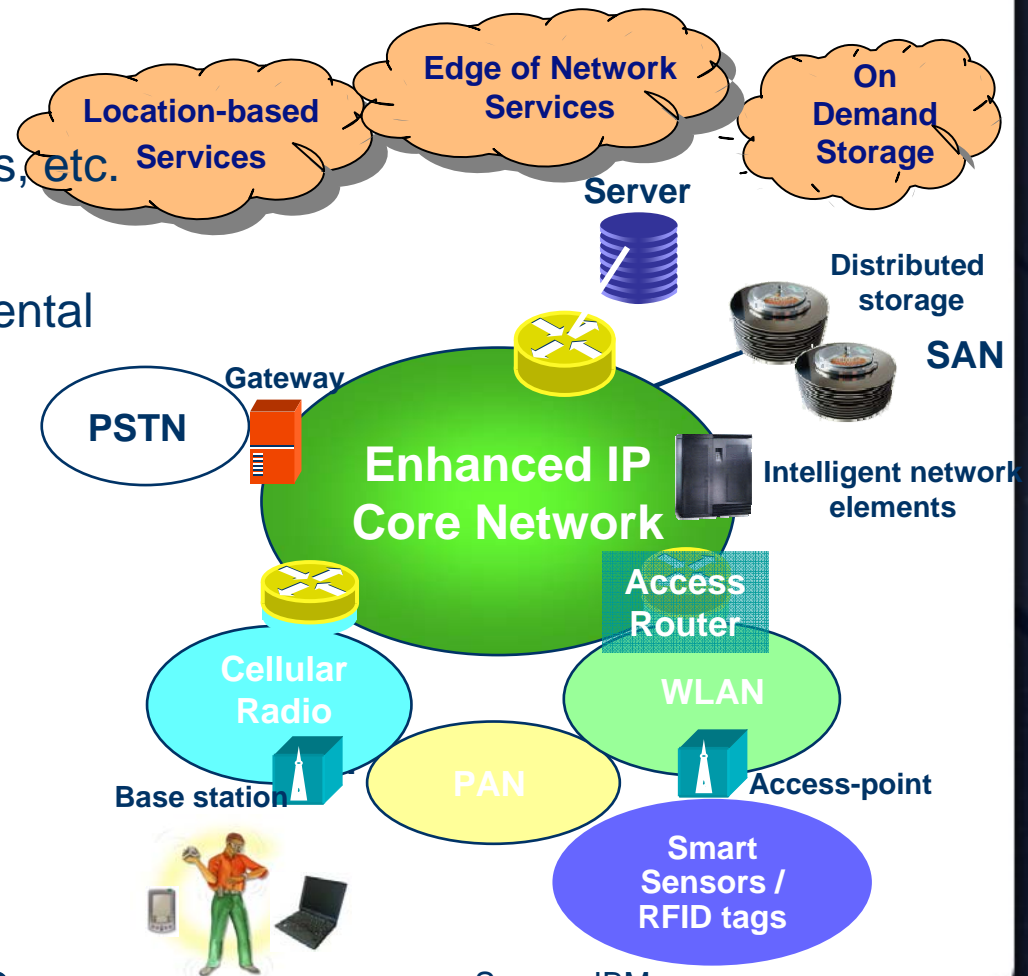

Source: IBM

# RFID on Construction Sites

## ■ Challenges:

- Cost overruns
- Safety troubles,
- Delays
- Quality issues continue

## ■ Construction project characteristics:

- Highly coordinated,
- Complex operation that must run according to schedule.
- Right supplies, tools, equipment and workers need to be in the right place at the right time.

## ■ Integration of construction site wired and wireless networks (sensor networks, RFID, voice and data).

- Integration of site networks with public communication network through a movable «communication container» providing systems to manage a private communication network for the many companies working in the same construction site.



# RFID on Construction Sites

## ■ RFID :

- Track the shipping and receipt of supplies
- Track tools—from hammers and screwdrivers to the more expensive jackhammers and welding supplies
- Reduce loss and theft.
- Heavy equipment providers that lease cranes, bulldozers and other machinery are testing or deploying RFID to keep track of assets and monitor their use, to maximize lease revenues and prevent equipment from sitting unused on a construction site for lengthy stretches.
- RFID to keep tabs on workers, ensuring both their safety and productivity.

Source: Stafford Tower Crane

Active tags combined with temperature sensors

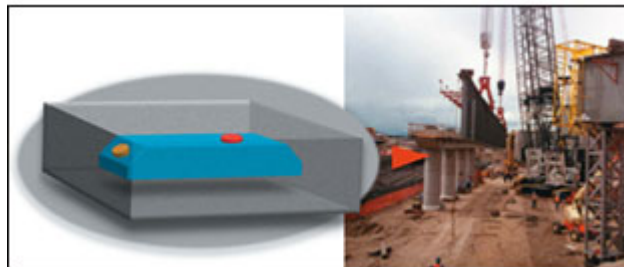

Tags are placed between the beams of the structure being constructed



Michigan Department of Transportation/Identec Solutions

# RFID Tracking

## RFID Personnel Tracking:

- In the direction sensing case a tag moving from one loop to another will have its travel direction identified by the Reader. If used with the Dual or Inward twin firmware each loop is managed independent of the other and the data relating to tags seen in each zone is processed on a separate output port.

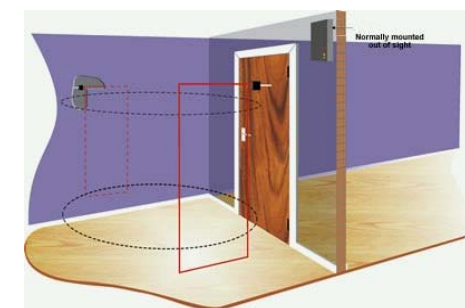
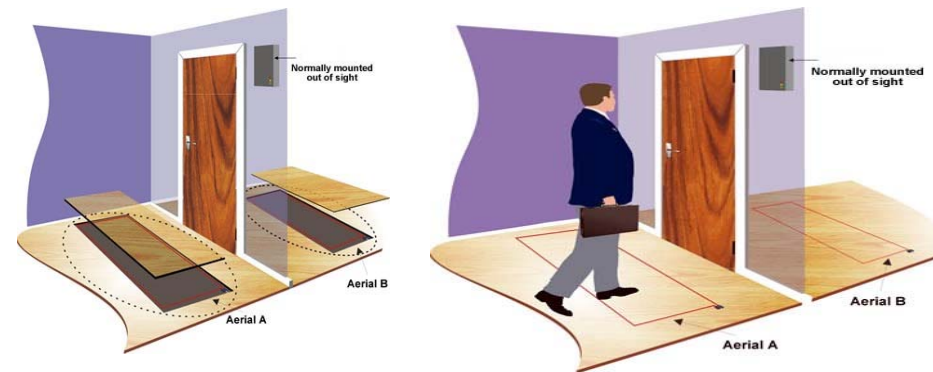

Source: <http://www.copytag.com/index.htm>

# RFID in the Office

- Sensor data collection
- Exploit moving nodes
- Exploit network coding for efficiency

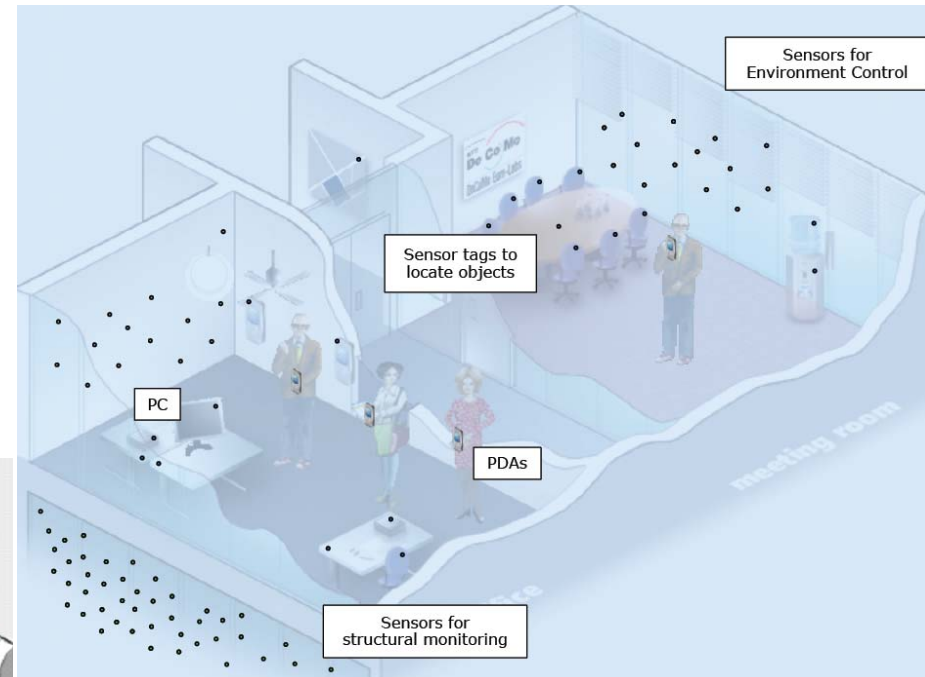

- Intelligent Buildings
- RFID Integration



# RFID at Home

- All home electronics devices are networked for comfortable life at home.
- Ubiquitous home is equipped with many kinds of home electronics and sensors, which are connected to network interfaces.
- Networked sensors recognize actions, movements and demands of people.



Infrared sensors at each room entrance, which detect in and out of people



Pressure sensors in the floor



Antennas in walls



Camera, microphone and speaker on the ceil



Displays

# Roads Bridges and RFID

- Strain Sensing System Using 13.56MHz passive-type Sensor-Integrated RFID.
- The system, measures the changes and deformation caused by various types of deterioration and loading on the structure, without using a battery.
- Embedded RFID sensor that is integrated within the concrete
- Measurements at a strain resolution level of approximately  $10 \times 10^{-6}$ .
- Using a thermistor, the system simultaneously measures temperature and can account for deformation caused by temperature.



Measures the sensor (white taping area on steel) from RFID tag (in blue) with a portable reader/writer with control PC

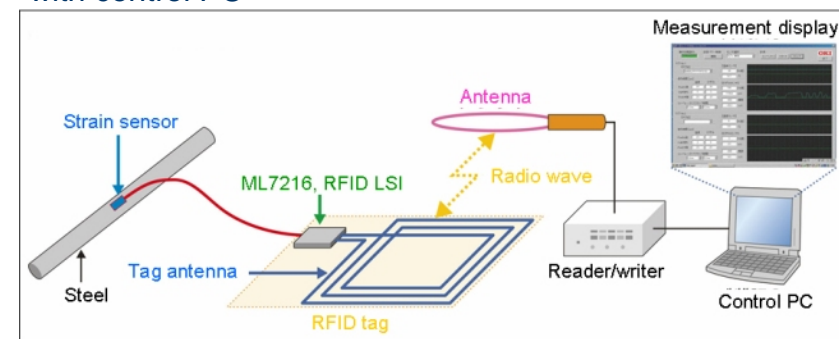

Efficient maintenance and management of roads, bridges and public housing. Concrete and steel structures monitoring due to everyday traffic, wind and earth pressure and earthquakes

Source: Oki Electric Industry Co., Ltd.

# Object Recognition and Tracking

- Maintaining situational awareness on dynamic construction site by improved knowledge of the location and movement of workers, construction equipment, and manufactured construction components.

- Automatic determination of information from intelligent site (e.g., employing camera networks, RFID/UWB/GPS-based asset tracking or real time location systems (RTLS) and laser-based 3D imaging systems)
- Use feedback from sensors that could provide construction object tracking to seed model-based recognition using camera networks and active emission 3D imaging systems (e.g. laser scanners, range cameras).



**Enabler for site safety, security, and productivity.**

# RFID for Quality Control

## ■ Concrete Testing



- eMbedded Visual Basic
- Microsoft Access
- Microsoft Active Sync



Material Management  
 Personnel Management  
 Tool Control  
 Quality Control  
 Safety

Source: National Taipei Technology University

# RFID for Precast Concrete



## ■ Concrete tracking



Targeting all phases:

Manufacturing,  
Construction,  
Facility management

Providing intelligence on facility components using RFID tags.



Source: Ruentex Corporation

# RFID Potential in Construction Sector

- Productivity improvements
- Availability of "real time" data capture using sensors
- Job tracking
- Improved quality control
- Improved stock control
- Reduction in paperwork
- Reduction in incidents and associated cost of sending incorrect products to site
- Improvement in customer information;
- Internet based customer information system
- Improved health and safety
- New value added for maintenance services.

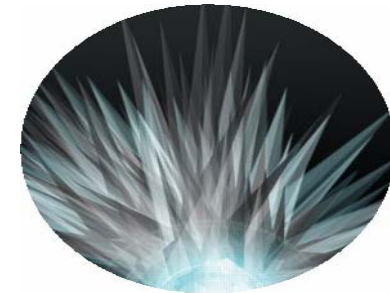
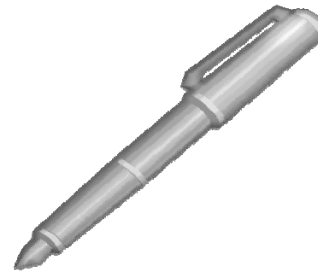

# Building Industry - Challenges

- No mature application of advanced logistics systems and the absence of information and identification systems in building industry.
- Lack of information of wireless sensors and RFID's potential in building industry.
- Active initiatives for implementing RFID and wireless communication in the industry
- RFID and wireless sensors implementation cases and successful pilots and trials



# Building Industry - Challenges

- Pluggable and interoperable components and equipments
- Extensible and reconfigurable solutions
- Dynamically adaptable management/control strategies
- Low cost systems
- Conservative industry and negative attitude towards new innovations and technology
- Trade-offs: Cost-Comfort-Functionality



# Technology - Comfort - Life Quality



- Security
- Energy savings
- Health and safety
- Multimedia, entertainment
- Ambient monitoring (sensors)
- IP and wireless communication
- Exploitation/maintenance management

# Challenges and Opportunities

