



# SINTEF REPORT

## SINTEF ICT

Address: NO-7465 Trondheim,  
NORWAY  
Location: O S Bragstads plass 2C  
NO-7034 Trondheim  
Telephone: +47 73 59 30 00  
Fax: +47 73 59 10 39

Enterprise No.: NO 948 007 029 MVA

TITLE

Simulation of DSL systems

AUTHOR(S)

Nils Holte, Vidar Ringset

CLIENT(S)

Post- og teletilsynet

REPORT NO. <b>SINTEF A1211</b>	CLASSIFICATION <b>Unrestricted</b>	CLIENTS REF. <b>Torgeir Alvestad</b>	
CLASS. THIS PAGE <b>Unrestricted</b>	ISBN <b>978-82-14-04050-0</b>	PROJECT NO. <b>90F238</b>	NO. OF PAGES/APPENDICES <b>121</b>
ELECTRONIC FILE CODE <b>Report_PT_2007.doc</b>	PROJECT MANAGER (NAME, SIGN.) <b>Vidar Ringset</b> <i>Vidar Ringset</i>	CHECKED BY (NAME, SIGN.) <b>Knut Grythe</b> <i>Knut Grythe</i>	
FILE CODE	DATE <b>2007-03-12</b>	APPROVED BY (NAME, POSITION, SIGN.) <b>Erik Kampenhøy, Resarch Director</b> <i>Erik Kampenhøy</i>	

### ABSTRACT

This report contains simulations of performance for different versions of ADSL, VDSL and SHDSL in 0.4 mm twisted pair cables. An important part of the work has been to investigate the compatibility between different DSL systems. The range of SHDSL system compliant with ITU G.991.2 Annex G has been analysed. These systems allow for bitrates up to 3.848 Mbit/s and 5.696 Mbit/s for 16-PAM and 32-PAM systems respectively.

The overall conclusion is that downstream ADSL and ADSL2+ is compatible with both SHDSL Annex G and HDSL systems. The degradation in bitrate of downstream ADSL due to these systems is moderate, less than 13% compared to a cable containing only ADSL systems.

ADSL subloop means that an ADSL DSLAM is installed between the local exchange and the subscriber. The purpose is to reduce the loop length between the DSLAM and the subscriber in order to increase the bitrate. This subloop signal will represent a strong interference in the downstream direction of the ADSL systems from the local exchange. As is shown in Section 7 in this report there is a severe degradation in the downstream direction of the ADSL system from the local exchange. The remedy to reduce this degradation is to use power backoff in the subloop systems. Use of power backoff regimes is not analysed in this report.

The potential bitrates for VDSL2 systems have been analysed for bandplans 997 and 998. The simulations show that bandplan 997 will give almost symmetrical up- and downstream bitrates for the cables less than 800 meters, whereas for bandplan 998 the downstream/upstream ratio is close to 2:1. Three different bandwidths have been analysed, 12 MHz, 17 MHz and 30 MHz. The frequency bands above 12 MHz are used only for loop lengths less than 800 meters. The frequency bands above 17 MHz are used only for loop lengths less than 650 meters. Bandplans that makes use of the lowest upstream band U0 can still provide adequate upstream capacity (1 Mbit/s) even for loop lengths in excess of 2 km. The downstream bitrate is significant (17-18 Mbit/s) for both 997 and 998 at these lengths.

A discussion of the use of ADSL in equalisation cables is given in Section 9. Alternative ways to install ADSL in pairs that contain 1+1 systems are presented in Section 10.

KEYWORDS	ENGLISH	NORWEGIAN
GROUP 1	Telecommunication	Telekommunikasjon
GROUP 2	Cables	Kabler
SELECTED BY AUTHOR	DSL	DSL



## TABLE OF CONTENTS

<b>1</b>	<b>Preface</b>	<b>7</b>
<b>2</b>	<b>Introduction</b>	<b>9</b>
2.1	List of abbreviations	10
<b>3</b>	<b>System description</b>	<b>11</b>
3.1	Network structure	11
3.2	Cable models	11
3.2.1	Attenuation model	11
3.2.2	Near end crosstalk model	12
3.2.3	Far end crosstalk model	13
3.2.4	Background noise model	13
3.3	Transmission systems	13
3.3.1	ISDN Basic Access	13
3.3.2	HDSL	13
3.3.3	SHDSL	14
3.3.4	ADSL	14
3.3.5	VDSL and VDSL2	15
3.3.6	E1-systems, 2.048 Mbit/s	15
3.3.7	Pair gain systems	15
3.4	Power spectra for different DSL systems	15
3.4.1	Power spectra for systems using the same frequency band up- and downstream transmission	16
3.4.2	Power spectra for ADSL and ADSL2+	18
3.4.3	Power spectra for VDSL2	21
3.4.3.1	VDSL2 bandplan 997	22
3.4.3.2	Bandplan 998	25
<b>4</b>	<b>Simulation models</b>	<b>29</b>
4.1	Simulation model for multicarrier systems	29
4.2	Simulation model for single carrier systems	29
<b>5</b>	<b>Simulation results for SHDSL</b>	<b>31</b>
5.1	SHDSL with 16-PAM modulation	31
5.2	SHDSL with 32-PAM modulation	32
5.3	Comparison of SHDSL systems using 16-PAM and 32-PAM modulation	34
<b>6</b>	<b>Simulation results for ADSL with all DSLAMs in the local exchange</b>	<b>37</b>
6.1	Simple illustrations of some important interference situations in ADSL systems	37
6.2	Downstream ADSL (254 – 1104 kHz) with all DSLAMs in the local exchange	42
6.2.1	Downstream ADSL with interference from ADSL systems	45
6.2.2	Downstream ADSL with interference from SHDSL 16-PAM	46
6.2.2.1	Downstream ADSL with interference from SHDSL on five pairs, varying bitrate	46
6.2.2.2	Downstream ADSL with interference from SHDSL 16-PAM 3848 Mbit/s, varying number of disturbers	47
6.2.3	Downstream ADSL with interference from SHDSL 32-PAM	48
6.2.3.1	Downstream ADSL with interference from SHDSL 32-PAM on 5 pairs, varying bitrate	48
6.2.3.2	Downstream ADSL with interference from SHDSL 32-PAM 5.696 Mbit/s, varying number of disturbers	49
6.2.4	Downstream ADSL with interference from HDSL without repeaters	50
6.2.4.1	Downstream ADSL with interference from One-pair HDSL	50
6.2.4.2	Downstream ADSL with interference from Two-pair HDSL	51
6.2.4.3	Downstream ADSL with interference from Three-pair HDSL	52
6.2.5	Downstream ADSL with interference from HDSL with repeaters	53
6.2.5.1	Downstream ADSL with interference from Two-pair HDSL with repeaters	53
6.2.5.2	Downstream ADSL with interference from Tree-pair HDSL with repeaters	54
6.2.6	Downstream ADSL with interference from E1-systems with repeaters	55
6.3	Downstream ADSL2+ (254 – 2208 kHz) with all DSLAMs in the local exchange	56
6.3.1	Downstream ADSL2+ with interference from ADSL2+	58
6.3.2	Downstream ADSL2+ with interference from SHDSL 16-PAM on 5 pairs without repeaters	59
6.3.3	Downstream ADSL2+ with interference from SHDSL 16-PAM 3848 kbit/s without repeaters	60
6.3.4	Downstream ADSL2+ with interference from SHDSL 32-PAM on 5 pairs without repeaters	61
6.3.5	Downstream ADSL2+ with interference from SHDSL 32-PAM 5696 kbit/s without repeaters	62

6.3.6	Downstream ADSL2+ with interference from One-, Two- and Three-pair HDSL without repeaters on 0, 1, 5 and 20 pairs .....	63
6.3.7	Downstream ADSL2+ with interference from Two-pair and Three-pair HDSL with repeaters on 0, 1, 5 and 20 pairs .....	66
6.3.8	Downstream ADSL2+ with interference from E1-systems (HDB3) with repeaters on 0, 1, 5 and 20 pairs .....	68
6.4	Upstream ADSL over ISDN (120 kHz – 276 kHz) with all DSLAMs in the local exchange .....	69
6.4.1	Upstream ADSL over ISDN with interference from ISDN .....	70
6.4.2	Upstream ADSL over ISDN with interference from ADSL .....	71
6.4.3	Upstream ADSL over ISDN with interference from SHDSL .....	72
6.4.3.1	Upstream ADSL over ISDN with interference from SHDSL 16-PAM 3.848 Mbit/s .....	72
6.4.3.2	Upstream ADSL over ISDN with interference from SHDSL 32-PAM 5.696 Mbit/s .....	73
6.4.3.3	Upstream ADSL over ISDN with interference from SHDSL 16-PAM on 5 pairs .....	74
6.4.3.4	Upstream ADSL over ISDN with interference from SHDSL 32-PAM on 5 pairs .....	75
6.4.4	Upstream ADSL over ISDN with interference from E1-systems .....	77
6.5	Upstream All Digital ADSL (3 – 276 kHz) with all DSLAMs in the local exchange .....	78
6.5.1	Upstream All Digital ADSL with interference from ISDN .....	79
6.5.2	Upstream All Digital ADSL2 with interference from ISDN and ADSL .....	80
6.5.3	Upstream All Digital ADSL with interference from SHDSL .....	81
6.5.3.1	Upstream All Digital ADSL with interference from SHDSL 16-PAM 3.848 Mbit/s, varying number of disturbers .....	81
6.5.3.2	Upstream All Digital ADSL with interference from SHDSL 32-PAM 5.696 Mbit/s, varying number of disturbers .....	82
6.5.3.3	Upstream All Digital ADSL with interference from SHDSL 16-PAM on 5 pairs, varying bitrate .....	83
6.5.3.4	Upstream All Digital ADSL with interference from SHDSL 32-PAM on 5 pairs, varying bitrate .....	84
6.5.4	Upstream All Digital ADSL with interference from HDSL .....	85
6.5.5	Upstream All Digital ADSL with interference from E1-systems with repeaters .....	86
<b>7</b>	<b>Simulation results for ADSL subloop .....</b>	<b>87</b>
7.1	Downstream ADSL from local exchange (254 – 1104 kHz) with subloop interference .....	87
7.1.1	Downstream ADSL with interference from subloop ADSL on 10 pairs .....	88
7.1.2	Downstream ADSL with interference from subloop ADSL on varying number of pairs .....	89
7.1.3	Downstream ADSL with interference from subloop ADSL on varying number of pairs .....	90
7.1.4	Downstream ADSL with interference from subloop ADSL on varying number of pairs .....	91
7.2	Downstream ADSL2+ from local exchange (254 – 2208 kHz) with subloop interference from ADSL .....	92
7.2.1	Downstream ADSL2+ with Interference from subloop ADSL on 10 pairs .....	93
7.2.2	Downstream ADSL2+ with interference from subloop ADSL on varying number of pairs. $L_{sub} = 0.75$ km .....	94
7.2.3	Downstream ADSL2+ with interference from subloop ADSL on varying number of pairs. $L_{sub} = 1.5$ km .....	95
7.2.4	Downstream ADSL2+ with interference from subloop ADSL on varying number of pairs. $L_{sub} = 2.5$ km .....	96
7.2.5	Downstream ADSL2+ with interference from subloop ADSL2+ on 10 pairs, variable $L_{sub}$ .....	97
7.2.6	Downstream ADSL2+ with interference from subloop ADSL2+ on varying number of pairs. $L_{sub} = 0.75$ km .....	98
7.2.7	Downstream ADSL2+ with interference from subloop ADSL2+ on varying number of pairs, $L_{sub} = 1.5$ km .....	99
7.2.8	Downstream ADSL2+ with interference from subloop ADSL2+ on varying number of pairs, $L_{sub} = 2.5$ km .....	100
<b>8</b>	<b>Simulation results for VDSL2 .....</b>	<b>101</b>
8.1	Downstream VDSL2 bandplan 997 .....	103
8.1.1	Downstream VDSL2, bandplan 997, B7-5 (25 kHz - 12 MHz.) .....	103
8.1.2	Downstream VDSL2, bandplan 997 B7-9 (25 kHz - 17.664 MHz.) .....	104
8.1.3	Downstream VDSL2, bandplan 997 B7-10 (25 kHz – 30 MHz.) .....	105
8.2	Upstream VDSL2, bandplan 997 .....	106
8.2.1	Upstream VDSL2, bandplan 997 B7-5 (25 kHz – 12 MHz) .....	106
8.2.2	Upstream VDSL2, bandplan 997 B7-9 (25 kHz – 17.664 MHz) .....	107
8.2.3	Upstream VDSL2, bandplan 997 B7-10 (25 kHz - 30 MHz) .....	108
8.3	Downstream VDSL2, bandplan 998 .....	109
8.3.1	Downstream VDSL2, bandplan 998 B8-7 (138 kHz – 12 MHz) .....	109

8.3.2	Downstream VDSL2, bandplan 998 B8-8 (138 kHz – 17.664 MHz).....	110
8.3.3	Downstream VDSL2, bandplan 998 B8-13 (276 kHz – 30 MHz).....	111
8.4	Upstream VDSL2, bandplan 998.....	112
8.4.1	Upstream VDSL2, bandplan B8-7 (138 kHz – 12 MHz).....	112
8.4.2	Upstream VDSL2, bandplan B8-8 (138 kHz – 17.664 MHz).....	113
8.4.3	Upstream VDSL2, bandplan B8-13 (276 kHz – 30 MHz).....	114
<b>9</b>	<b>Use of ADSL in a network containing equalization cables.....</b>	<b>115</b>
<b>10</b>	<b>Alternative ways to install DSL in pairs that contain 1+1 systems.....</b>	<b>117</b>
<b>11</b>	<b>Conclusions .....</b>	<b>119</b>
<b>References</b>	<b>.....</b>	<b>121</b>



## **1 Preface**

The work documented in this report have been conducted under contract no 90-KO060009/A06-1075500 financed by the Norwegian Post and Telecommunication Authority (Post- og Teletilsynet), SINTEF project number 90F238. The work has been carried out in the period April 2006 to February 2007.





## **2 Introduction**

The Norwegian access network consists of twisted pair cables in sizes from a few pairs up to 2000 pairs. The different pairs in a twisted pair cable are just packed together within a cable sheath, and hence there is electromagnetic coupling between the different pairs. The signal in one pair couples into the other pairs in the same cable. Coupling between signals with different directions of transmission is denoted near end crosstalk (NEXT), and coupling between signals with the same direction of transmission is denoted far end crosstalk (FEXT). Crosstalk is one of the most important noise mechanisms in twisted pair cables and limits the potential reach of different transmission systems. This means that one user could significantly degrade the transmission rate of the other users within the same cable. Each pair of a cable has a large potential channel capacity, and in order to exploit the cable efficiently it is important that all transmission systems have a sufficient degree of compatibility. Several different operators are using Telenor's cables according to the rules of LLUB (Local Loop UnBundling). All operators present in the access network will have to comply with a common set of rules for exploiting the cables, and operators will all benefit from a high degree of compatibility.

A variety of different systems are present in the access network today, and there is a further development of DSL systems. This leads to both new standards as well as amendments to existing standards.

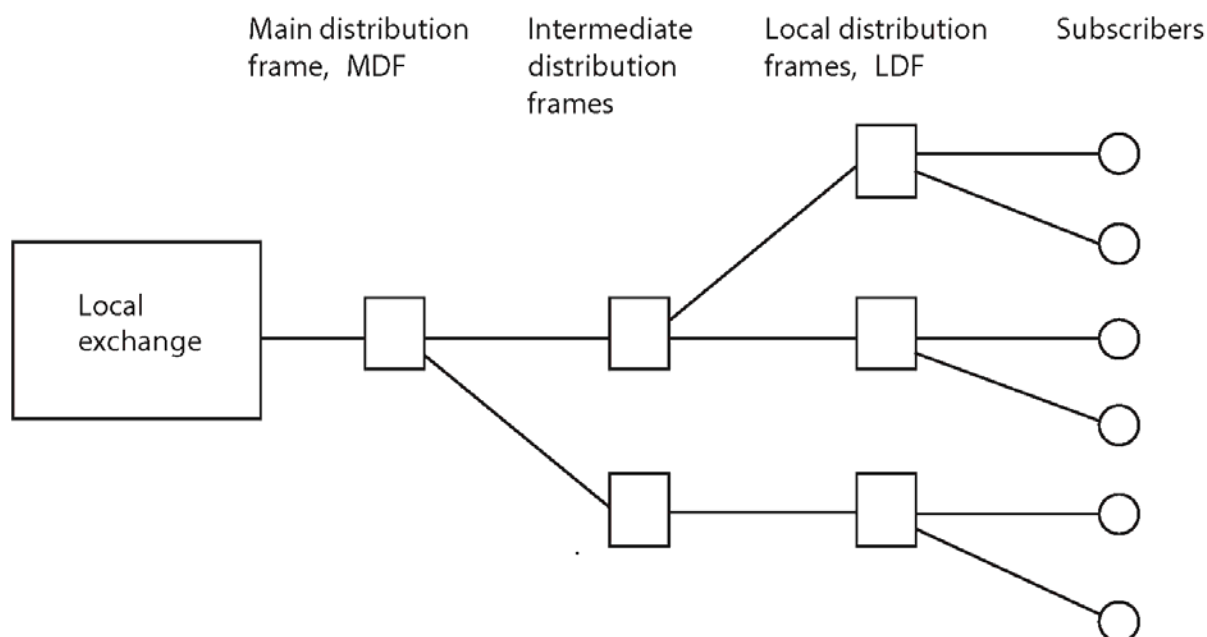
SINTEF carried out an evaluation of the existing transmission systems in the Norwegian access network in 2002 [1]. The most important changes since 2002 has been the extension of ADSL to ADSL2+, the finalisation of the standard for VDSL as well as the extension to VDSL2. The SHDSL standard has also been extended to significantly higher bitrates as defined in a new Annex G. A main objective in this work is to evaluate the compatibility between both these new systems and the main existing transmission systems in the twisted pair cables. Another important objective is to calculate the consequences of installing ADSL and ADSL2+ in subloop.

## 2.1 List of abbreviations

2B1Q	Four level line code (two Bits to one Quaternary symbol)
ADSL	Asymmetrical Digital Subscriber Line (ITU G.992.1)
ADSL2	Newer version of ADSL (ITU G.992.3)
ADSL2+	Extended version of ADSL (ITU G.992.5)
DMT	Discrete Multitone Modulation (multicarrier modulation)
DSL	Digital Subscriber Line, common term for all types of systems
DSLAM	Digital Subscriber Line Access Multiplexer
E1	The first order system of the European plesiochronous multiplexing hierarchy
ETSI	European Telecommunications Standards Institute
FEXT	Far end crosstalk
HDSL	High bitrate Digital Subscriber Line
HDB3	High Density Bipolar order 3 encoding (line code)
ISDN	Integrated Services Digital Network
ISDN BA	Integrated Services Digital Network – Basic Access
ITU	International Telecommunications Union
LDF	Local Distribution Frame
LLUB	Local Loop Unbundling
MDF	Main Distribution Frame
NEXT	Near end crosstalk
OA	Operator Access
PAM	Pulse Amplitude Modulation
PE	Polyethylene
PSD	Power Spectral Density
PSK	Phase Shift Keying
POTS	Plain Old Telephone System (analogue telephone)
QAM	Quadrature Amplitude Modulation
SHDSL	Single pair High bitrate Digital Subscriber Line
TCPAM	Trellis Coded Pulse Amplitude Modulation
VDSL	Very high speed Digital Subscriber Line (ITU G.993.1)
VDSL2	Extended version of VDSL (ITU G.993.2)

### 3 System description

#### 3.1 Network structure



**Figure 3.1 Basic structure of access network.**

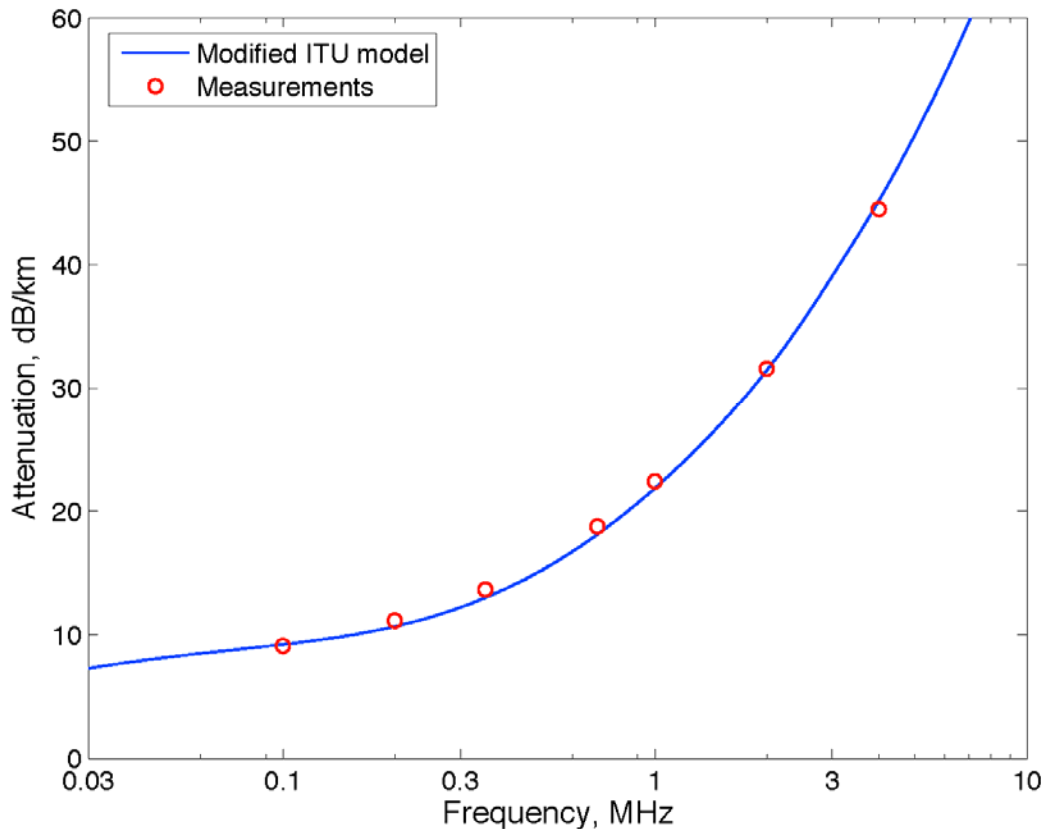
The basic structure of the access network is in principle a tree structure as indicated in Figure 3.1. All subscribers are connected to the local exchange by twisted pair cables, and the different cables are cross-connected through a hierarchy of distributors.

#### 3.2 Cable models

This study has been based on 0.4 mm PE insulated twisted pair cables only. Further calculations will be necessary to include other conductor diameters and other cable types. However, attenuation is approximately inversely proportional to the conductor diameter above a few hundred kHz. Hence, the maximum reach for 0.5 mm and 0.6 mm cables are approximately 25% and 50% longer, respectively, than for a 0.4 mm cable.

##### 3.2.1 Attenuation model

The attenuation model used in this report has been based upon the model for 0.4 mm polyethylene insulated cable presented in ITU Recommendation G.996.1 [2]. However, this model corresponds to American cables with capacitance 50 nF/km. The model has been modified to capacitance 45 nF/km by increasing the thickness of the insulation. The ITU model has primarily been developed for use in the ADSL frequency band. In the VDSL standards [11] and [12] it is common to assume that the attenuation is proportional to the square root of the frequency. Hence the attenuation model has been modified so that the attenuation constant is proportional to  $\sqrt{f}$  from 3 MHz and above. This modified ITU model is shown in Figure 3.2. Measurements for Norwegian cables [17] are also shown in the figure, and there is good correspondence between the model and the measurements.



**Figure 3.2 Attenuation constant for the modified ITU model.**

### 3.2.2 Near end crosstalk model

An empirical model of NEXT is presented in ITU Recommendation 996.1 [2]. The 99% confidence limit of near end crosstalk power sum in a 50-pair binder group is given by:

$$|H_{NE99}(f)|^2 = 8.818 \cdot 10^{-5} \cdot \left(\frac{N}{49}\right)^{0.6} \cdot F^{1.5} \quad (1)$$

$N$  is the number of disturbing pairs within the binder group.

$F$  is the frequency in MHz.

This model has been used in the simulations. The model is not fully representative because Norwegian twisted pair cables are based on 10-pair binder groups instead of 50-pair binder groups. However, comparisons with measurements for Norwegian PE-insulated twisted pair cables [17] show reasonable agreement with the model, comparing the same percentage of disturbing pairs within a binder. The measurements indicate that the model may be slightly pessimistic with respect NEXT in Norwegian cables. These deviations will be of minor importance in the relative comparisons in this report.

This model has been developed for frequencies above 100 kHz. NEXT will have different frequency variation at low frequencies. It has been assumed that the 15 dB/decade variation holds down to 10 kHz, and that that NEXT below 10 kHz is the same as at 10 kHz. This is in accordance with measurements of NEXT, and it is a slightly pessimistic assumption.

### 3.2.3 Far end crosstalk model

An empirical model of FEXT is presented in ITU Recommendation 996.1 [2]. The 99% confidence limit of far end crosstalk power sum in a 50-pair binder group is given by:

$$|H_{FE99}(f)|^2 = 2.624 \cdot 10^{-4} \cdot \left(\frac{N}{49}\right)^{0.6} \cdot F^2 \cdot L \quad (2)$$

$L$  is the cable length in km.

This model has been used in the simulations. The difference between 50-pair binder groups in the model and 10-pair binder groups in the Norwegian cables is relevant for FEXT also. However, comparisons with measurements [17] for Norwegian PE-insulated twisted pair cables show very close agreement with the FEXT level of the model.

This model has been developed for frequencies above 100 kHz. It is assumed that FEXT below 100 kHz is the same as at 100 kHz. This is in accordance with measurements of FEXT, and it is a slightly pessimistic assumption.

### 3.2.4 Background noise model

ETSI has published different models [3] that describe the background noise in twisted pair cables. These models describe the typical noise caused by crosstalk and RF noise that is present in practical cables. The ETSI model type A without RF tones has been used as model for background noise. For frequencies above 795 kHz this model is identical to the usual model for white noise used in DSL with power spectral density of -140 dBm/Hz.

## 3.3 Transmission systems

The most important transmission systems used in the access network will be described in the following sections. Interference generated by these systems has been taken into account in this report.

### 3.3.1 ISDN Basic Access

The version of ISDN BA used in Norway operates with line code 2B1Q (four level PAM) and line speed 160 kbit/s. The specifications are given in ITU recommendation G.961 [4]. The nominal power spectrum for ISDN BA is shown in Section 3.4.1. The major part of the spectrum is below 80 kHz, so that interference from ISDN BA is usually negligible for most DSL systems, except for the upstream direction of ADSL.

ISDN BA has a very high penetration in the Norwegian access network. It is currently used in approximately one third of the access lines, and a significant penetration is expected to continue. Hence, the future use of the access network must be fully compatible with ISDN BA.

### 3.3.2 HDSL

One important role of HDSL systems is to provide 2 Mbit/s symmetrical access. There are three alternatives that operate over one, two or three pairs and which are denoted One-pair HDSL, Two-pair HDSL and Three-pair HDSL respectively. Another role of HDSL is to implement symmetrical systems with rate  $N \times 64$  kbit/s over one pair. Telenor's specification for providing  $N \times 64$  kbit/s with HDSL is given in OA 104 [5]. Systems with  $N \leq 12$  this corresponds to Three-pair HDSL,  $N \leq 18$  corresponds to Two-pair HDSL, and  $N \leq 36$  corresponds to One-pair HDSL.

The HDSL systems use line code 2B1Q and consequently have a relatively wide spectrum. It uses two-way baseband transmission and will hence cause NEXT interference to other systems. The

specifications are given in ITU recommendation G.991.1 [6]. The nominal power spectra for HDSL systems used in this report are shown in Section 3.4.1.

Systems like HDSL that use two-way transmission within the same frequency band may cause much severe interference into other DSL systems if repeaters are used, compared to a case without repeaters. The worst case NEXT from HDSL into the downstream direction of transmission will occur for the HDSL modems/repeaters located at the largest distance from the local exchange. This type of interference is particularly critical for ADSL systems. When repeaters are not used, the maximum distance from the local exchange is limited by the maximum reach of the HDSL system, but when repeaters are permitted there is no such limitation. One-pair HDSL systems are always used without repeaters. Two and three-pair HDSL systems can be used both with and without repeaters.

There is a significant use of HDSL systems in the Norwegian access network. In new installations HDSL has mainly been replaced by SHDSL, which has a narrower spectrum and better performance. However, a significant number of HDSL systems will be present in the access network for several years from now.

### 3.3.3 SHDSL

SHDSL is a system that implements symmetrical transmission rates of  $N \times 64$  kbit/s up to 2.304 kbit/s over one pair in its present version. SHDSL is used to implement symmetrical systems with rate  $N \times 64$  kbit/s over one pair. Telenor's specification for providing  $N \times 64$  kbit/s with SHDSL is given in OA 107 [5].

The present SHDSL system uses 16-level PAM modulation and trellis coded modulation and is hence more spectral efficient than HDSL. It uses two-way baseband transmission and will cause NEXT interference to other systems. SHDSL systems are used without repeaters. The specification is given in ITU recommendation G.991.2 [7]. An extended version of SHDSL has been standardized in Annex G of the same recommendation and uses 32-PAM modulation and bitrates up to 5696 kbit/s. The nominal spectra of different versions of SHDSL are given in Section 3.4.1.

### 3.3.4 ADSL

ADSL systems are providing subscriber access with asymmetric upstream and downstream bitrates, and there are three main versions given in ITU recommendations; ADSL [8] (G.992.1) and ADSL2 [9] (G.992.3) with bandwidth 1.1 MHz and ADSL2+ [10] (G.992.5) with extended bandwidth 2.2 MHz. The maximum bitrate in the downstream direction is 8 Mbit/s for ADSL/ADSL2 and 24 Mbit/s for ADSL2+.

Three slightly different definitions of the term ADSL is used in this report. Firstly, the ITU standard G.992.1 is denoted ADSL. ADSL and ADSL2 are almost identical for the aspects discussed in this report, but the ADSL2 standard has been used in all simulations of 1.1 MHz systems. For simplicity, we have used ADSL to denote both versions of ADSL with 1.1 MHz bandwidth (ADSL and ADSL2). ADSL is also used as a common notation for all different versions of ADSL systems (ADSL, ADSL2, and ADSL2+). Reference to the specific system is given at places where it is not clear from the context which definition is used.

All ADSL system use multicarrier modulation (DMT). The modulation on each subcarrier is adapted according to the signal to noise ratio and use trellis coded modulation with signal constellations varying from 4-PSK to 56536-QAM.

Two versions of upstream ADSL are currently permitted in Norway as described in Telenor's specifications OA105 [5]. The main alternative is compatible with ISDN on the same pair and is defined in Annex B of the standards and is denoted ADSL over ISDN. The other alternative is

ADSL in accordance with Annex J of the standards, where also the ISDN band is used for upstream transmission. This version is denoted All Digital ADSL. All Digital ADSL exploits the frequency band from 4 to 276 kHz for upstream transmission and cannot use other transmission systems on the same line. Both alternatives use separate frequency bands of upstream and downstream transmission. Peak power spectra for all alternatives of upstream and downstream transmission in ADSL systems are presented in Section 3.4.2.

ADSL and ADSL2+ are two of the most important transmission systems in the access network. ADSL and ADSL2+ are also quite sensitive to interference from other transmission systems, both because one-way transmission is used, and because of overlap of frequency bands with other systems. Hence, this report puts a main emphasis on the consequences of interference into ADSL and ADSL2+ caused by all the other relevant transmission systems.

### **3.3.5 VDSL and VDSL2**

VDSL and VDSL2 systems will provide symmetrical or asymmetrical access over short loops (typically up to 1km). The standards are given in [11] and [12]. VDSL and VDSL2 use multicarrier modulation (DMT) with adaptive modulation in each subchannel. One-way transmission is used at in each frequency band, and there are two main band plans. Bandplan 998 was originally developed for USA and provides a higher downstream rate than upstream bitrate. Bandplan 997 was originally developed for Europe and provides more symmetrical upstream/downstream bitrates. Both bandplans for VDSL are compatible with the frequency allocations in ADSL, so that there are no major conflicts between ADSL and VDSL. VDSL2 is mainly an extension of VDSL, and all simulations in this report have been based on the VDSL2 standard.

### **3.3.6 E1-systems, 2.048 Mbit/s**

Primary rate ISDN and 30 channel PCM systems have been provided over 2.048 Mbit/s E1-systems that use line code HDB3. This is a two-way transmission system with a wide spectrum that will cause NEXT interference to other systems. The spectrum overlaps the entire frequency band of ADSL. The specification is given in ITU recommendation G.703 [13]. The nominal power spectrum for an E1-system used in this report is shown in Section 3.4.1.

A significant number of E1-systems are still in operation in the access network and repeaters are often used. When E1-systems are present in a cable, the performance of ADSL will be seriously reduced, and this degradation is analysed in the current report.

### **3.3.7 Pair gain systems**

There has been some shortage on cable pairs in the Norwegian subscriber network, so that it has been common to use pair gain systems like FM modulated analogue pair gain systems. Interference from analogue pair gain systems will not be considered in this report. However, pairs shared by two subscribers represent challenges for the installation of DSL systems. A discussion on how to install ADSL systems in pairs that have been used for 1+1 pair gain systems is presented in Section 10.

## **3.4 Power spectra for different DSL systems**

In the context of this report the nominal transmitted power spectrum is the most important property of a system. The different systems that will be considered can be divided in two groups; Symmetrical systems using the same frequency bands and asymmetrical systems using separate frequency bands for upstream and downstream transmission. ISDN BA, HDSL, SHDSL, and E1-systems are symmetrical systems whereas ADSL and VDSL are asymmetrical systems.

### 3.4.1 Power spectra for systems using the same frequency band up- and downstream transmission

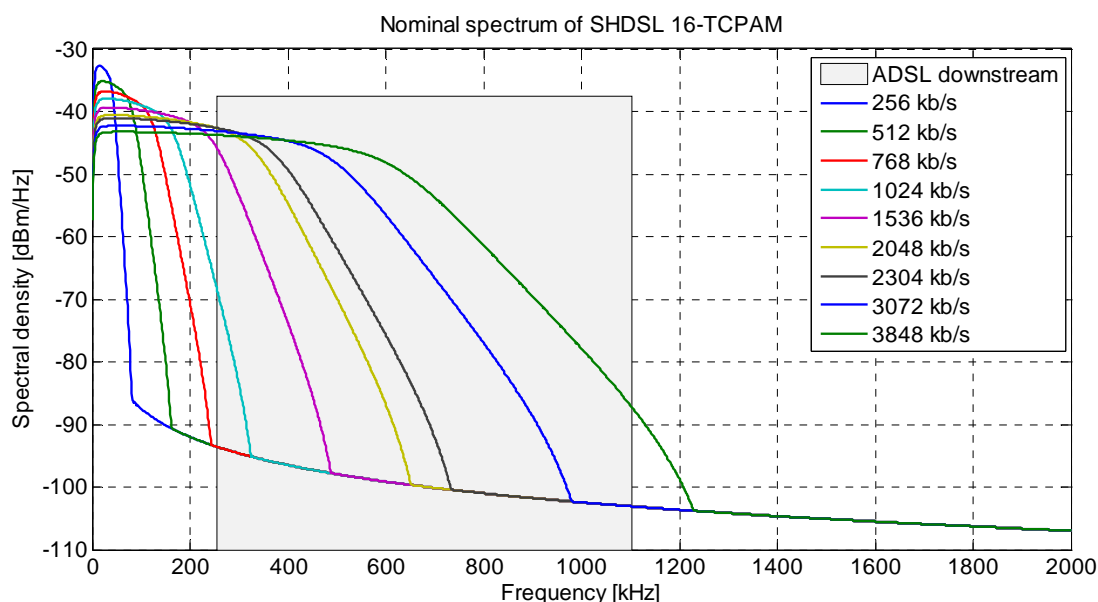
The power spectra for the following systems are given in Figure 3.3 to Figure 3.7:

- SHDSL 16-PAM (Figure 3.3)
- SHDSL 32-PAM (Figure 3.4)
- HDSL one-pair system (Figure 3.5)
- HDSL two-pair system (Figure 3.5)
- HDSL three-pair system (Figure 3.5)
- ISDN Basic Access (Figure 3.6)
- E1-systems using HDB3 line code (Figure 3.7)

The downstream PSD mask for ADSL is also given in the same figures. The dominant interference mechanism from these systems into ADSL is near end cross talk.

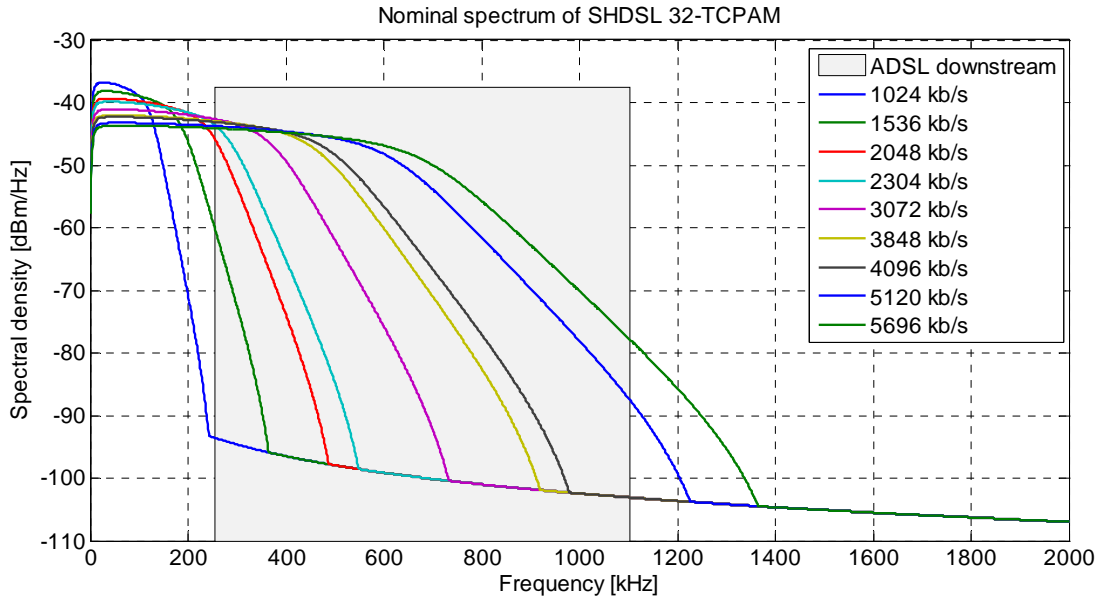
ADSL downstream band shows almost no overlap with SHDSL below 1536 kbit/s for 16-PAM and 2048 kbit/s for 32-PAM. The overlap for higher bitrates is moderate since the SHDSL signal is attenuated in large part of the ADSL downstream band. For HDSL systems the overlap on the ADSL downstream band is insignificant for a HDSL three-pair system and small for a two-pair system. There is a significant overlap between downstream ADSL and HDSL one-pair systems, but the level of the HDSL signal is low in large parts of the bandwidth. ISDN Basic Access shows no overlap with downstream ADSL, except for sidelobes, and will therefore not degrade downstream ADSL performance.

E1-systems are overlapping with the entire downstream bands both for ADSL and ADSL2+. These systems will, as shown later in this report, severely degrade downstream transmission for both ADSL and ADSL2+.

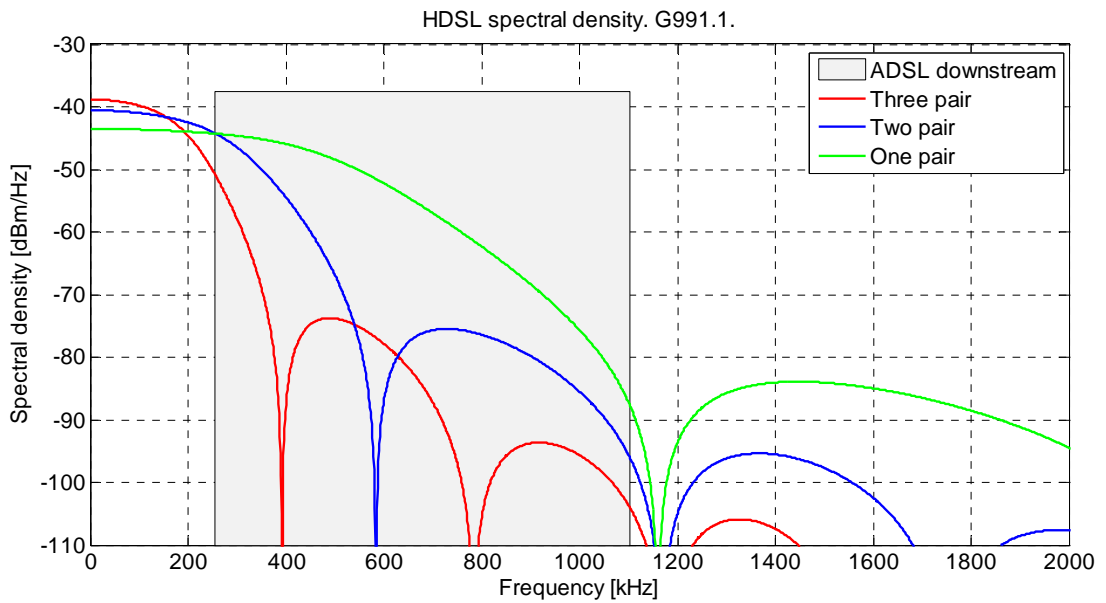


**Figure 3.3 Power spectra of SHDSL 16-PAM for bitrates 256 kbit/s to 3848 kbit/s.**

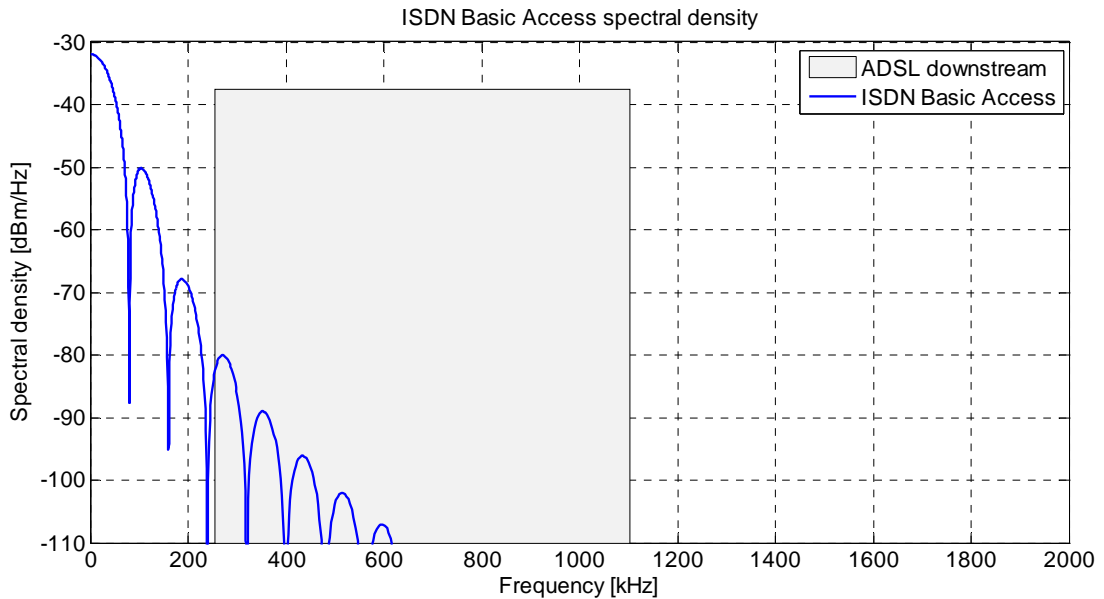




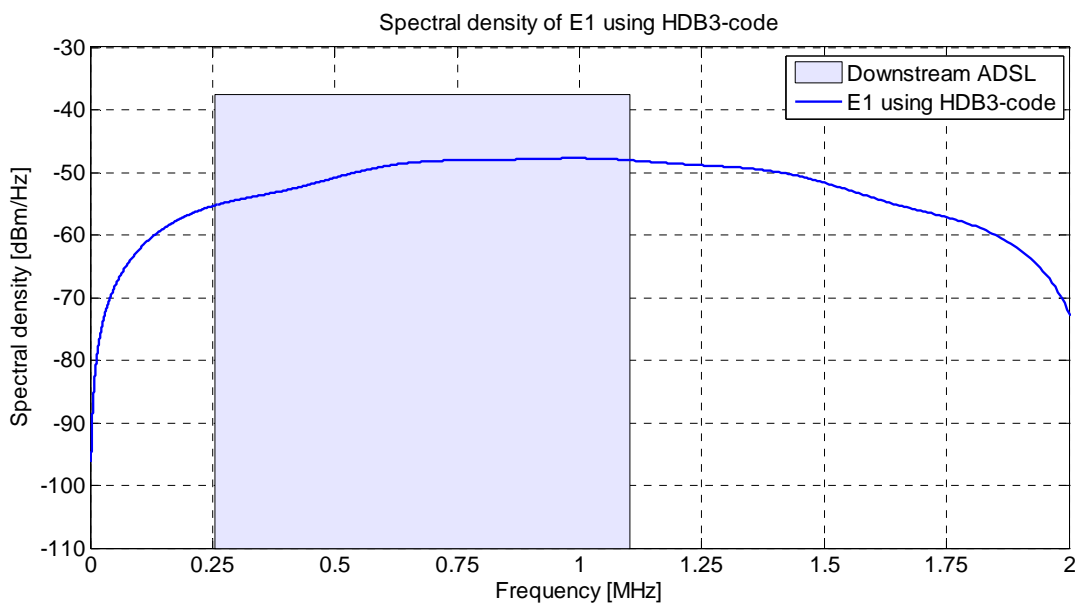
**Figure 3.4 Power spectra of SHDSL 32-PAM for bitrates 1024 kbit/s to 5696 kbit/s.**



**Figure 3.5 Power spectra of HDSL for one-pair, two-pair and three-pair systems.**



**Figure 3.6 Power spectrum for ISDN basic access.**



**Figure 3.7 Power spectrum for E1-systems using HDB3 line code.**

### 3.4.2 Power spectra for ADSL and ADSL2+

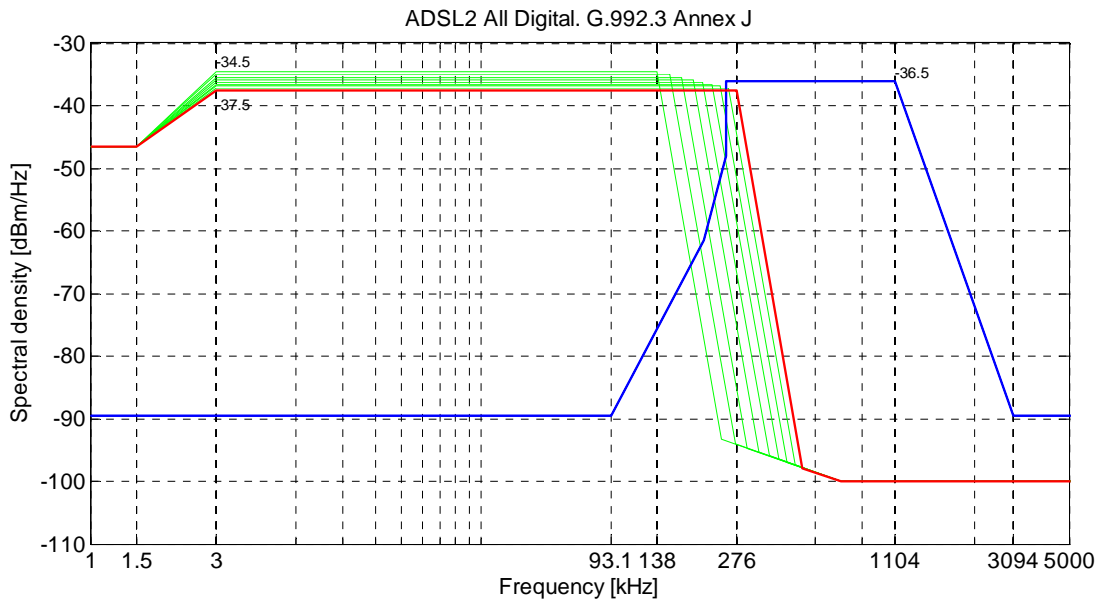
This report includes both ADSL and ADSL2+ systems. The main difference between ADSL and ADSL2+ is the bandwidth of the downstream band:

- 254 kHz to 1104 kHz for ADSL (G.992.3 Annex B Fig B.2)
- 254 kHz to 2208 MHz for ADSL2+ (G.992.5 Annex B, Fig B.2)

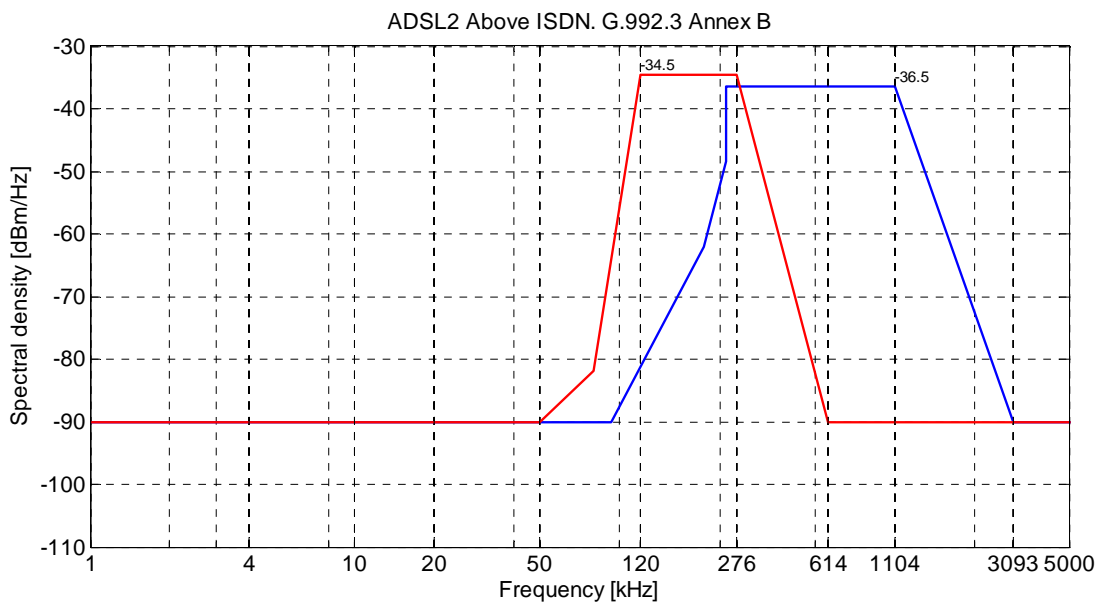
The upstream bands for these systems are identical. Two options for the frequency allocation of the upstream band are simulated both for ADSL and ADSL2+:

- All Digital ADSL 3 kHz – 276 kHz (G.992.3/G.992.5 Annex J, Fig J.1)
- ADSL above ISDN 120 kHz – 276 kHz (G.992.3/G.992.5 Annex B, Fig B.3)

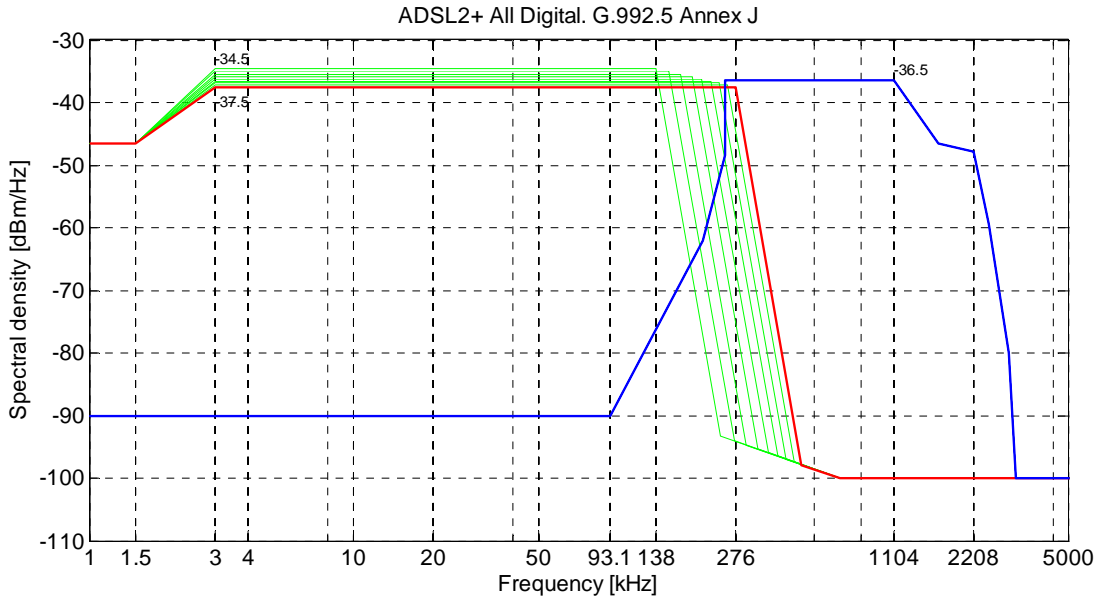
The spectra for these systems are shown in Figure 3.8 to Figure 3.11, upstream in red and green, downstream in blue. These figures show the maximum power spectral density (PSD) allowed vs. frequency. The nominal in-band PSD is 3.5 dB lower than this limit. Several options for the upstream frequency allocation exist where the upper limit for the upstream band varies from 138 to 276 kHz. In the simulated performance of ADSL, which is presented in a later chapter in this report, an upstream band from 3 – 276 kHz has been used. In all cases for the ADSL systems the up- and downstream bands are overlapping in the frequency range 254 kHz to 276 kHz.



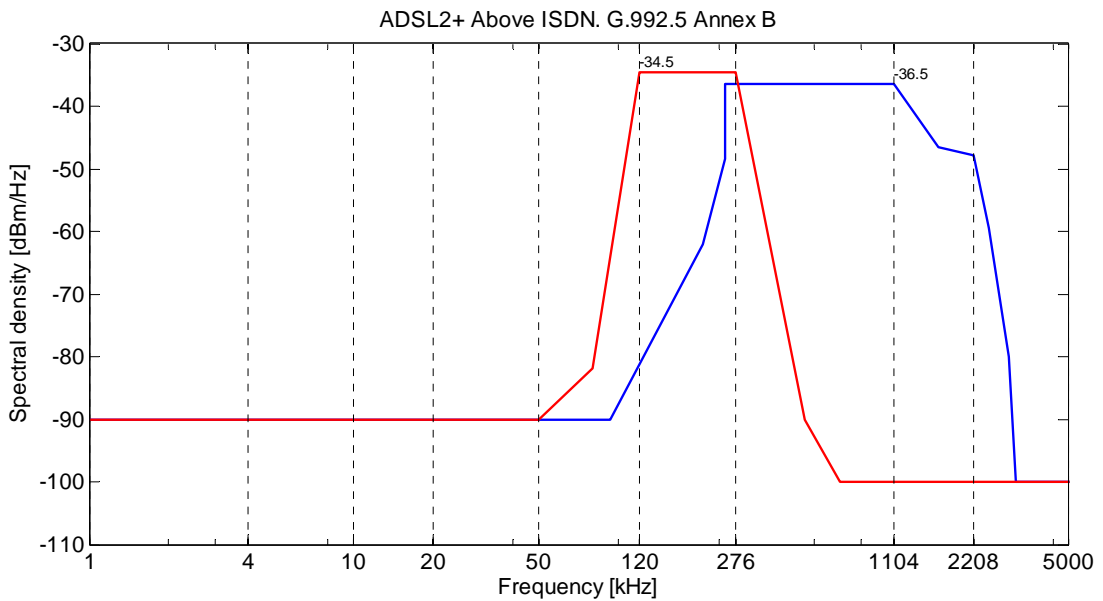
**Figure 3.8 Peak PSD limits for All Digital ADSL. Upstream in red and downstream in blue.**



**Figure 3.9 Peak PSD limits for ADSL above ISDN. Upstream in red and downstream in blue.**



**Figure 3.10 Peak PSD limits for All Digital ADSL2+. Upstream in red and downstream in blue.**



**Figure 3.11 Peak PSD limits for ADSL2+ above ISDN. Upstream in red and downstream in blue.**

### 3.4.3 Power spectra for VDSL2

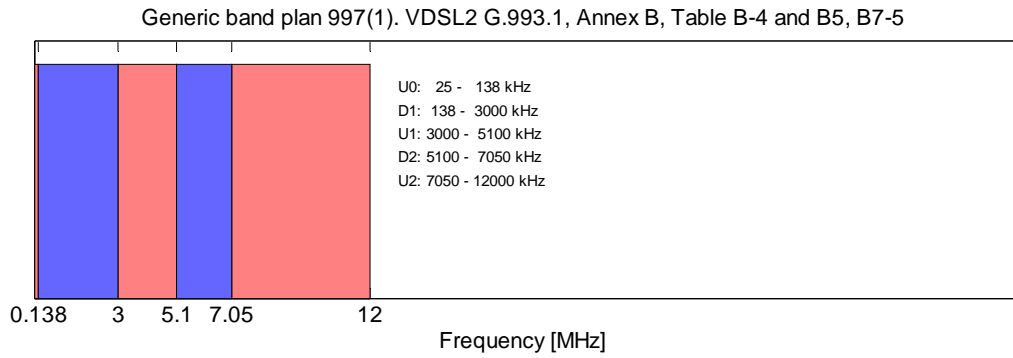
Six different cases of VDSL2 have been simulated and the spectra for these cases are shown in Figure 3.12 to Figure 3.23, red for the upstream and blue for the downstream. Three cases for each of the bandplans 997 and 998 have been simulated. The upper band limits for the three cases are 12, 17.664 and 30 MHz. A summary of the simulated systems is given in the table below.

**Table 3.1 Summary of simulated VDSL2 systems**

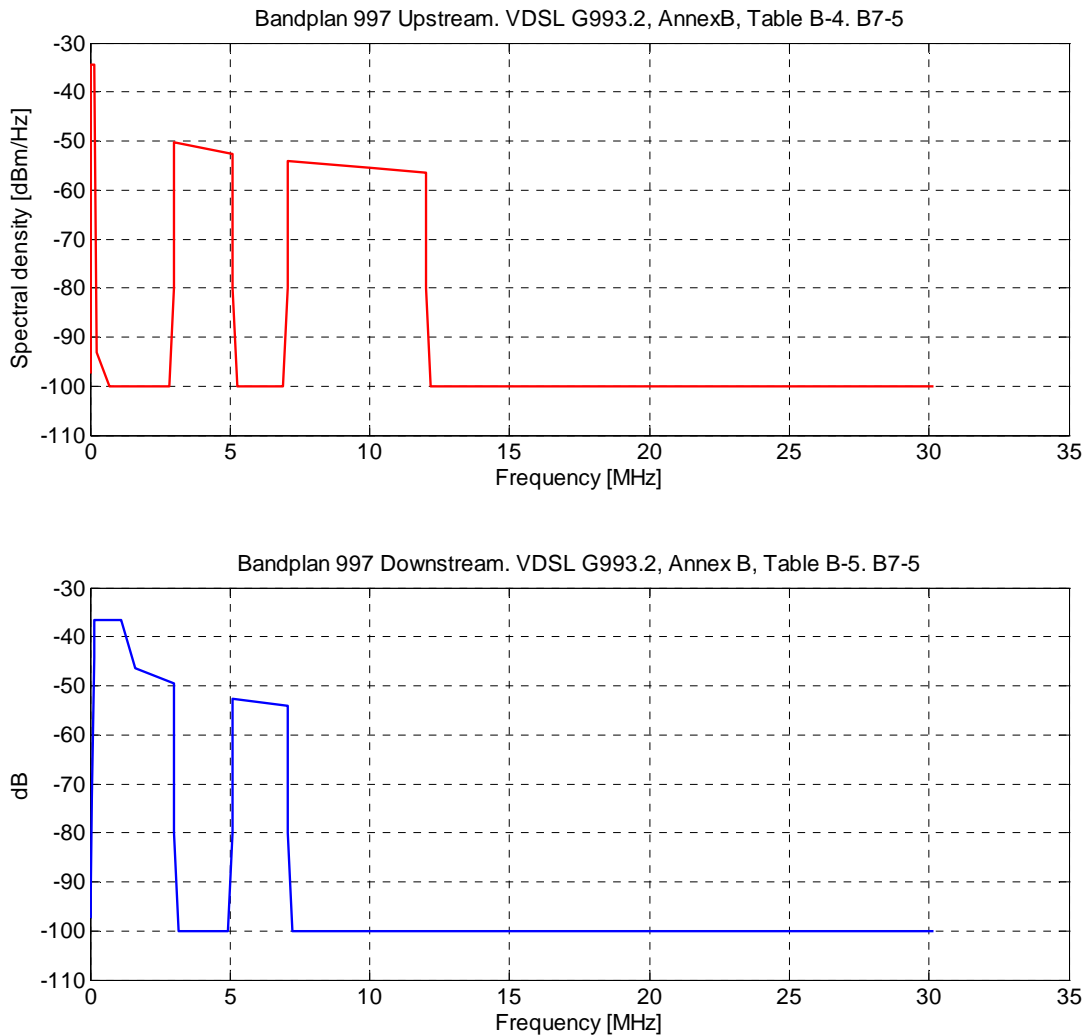
Bandplan	Name	Lower frequency limit	Upper frequency limit	Number of upstream bands	Number of down-stream bands
997	B7-5	25 kHz	12 MHz	3 (incl U0)	2
997	B7-9	25 kHz	17.664 MHz	4 (incl U0)	3
997	B7-10	25 kHz	30 MHz	5 (incl U0)	4
998	B8-7	138 kHz	12 MHz	2 (no U0)	2
998	B8-8	138 kHz	17.664 MHz	2 (no U0)	3
998	B8-13	276 kHz	30 MHz	3 (no U0)	4

The detailed specification of the different PSD masks can be found in the ITU standards referred to in each case. The major difference between bandplan 997 and 998 is the allocation between upstream and downstream bitrate. Bandplan 997 is more symmetrical, i.e. up- and downstream bitrates are almost equal. In 998 more bandwidth is allocated for downstream traffic.

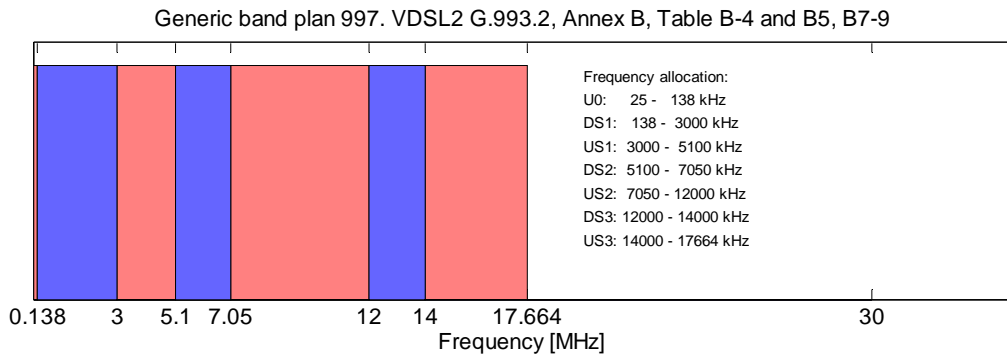
**3.4.3.1 VDSL2 bandplan 997**



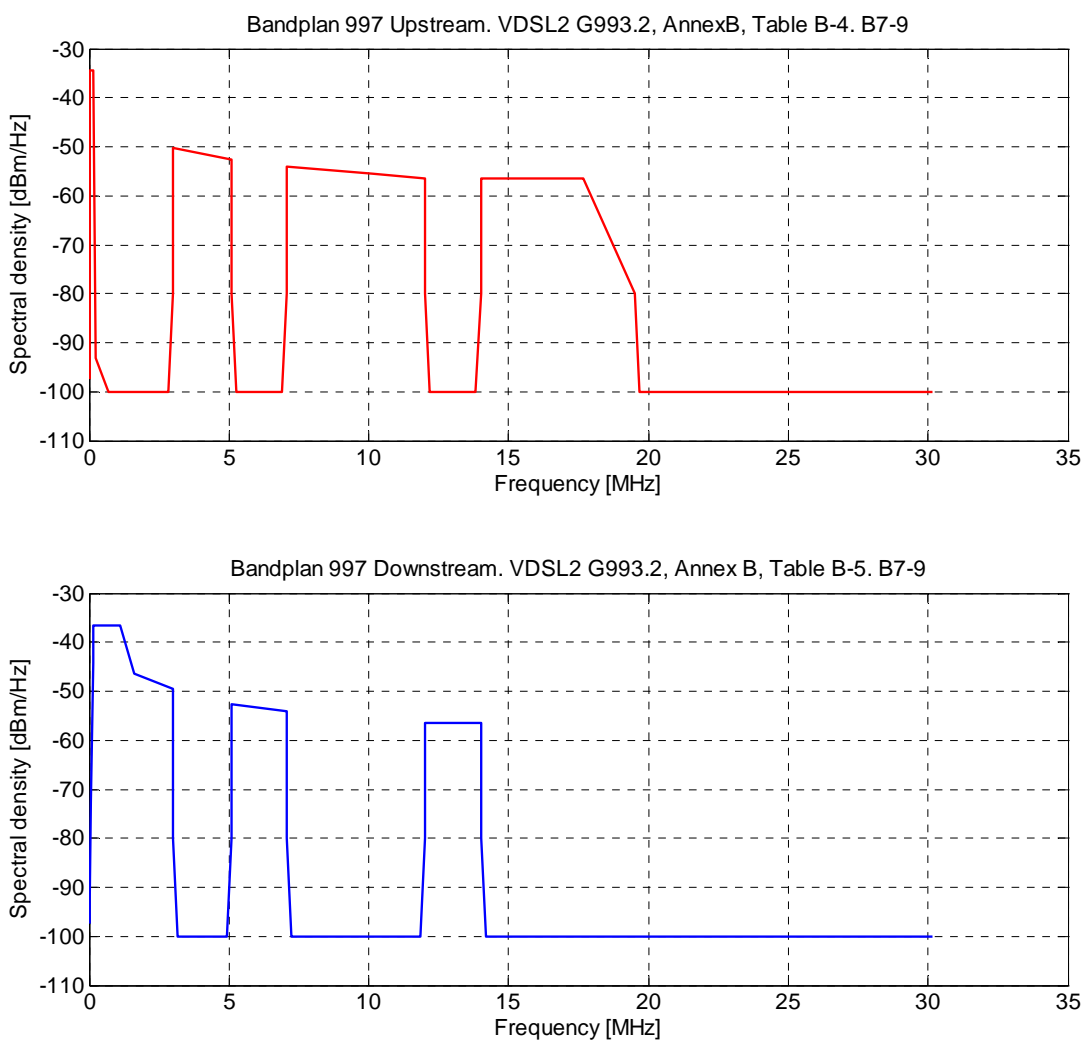
**Figure 3.12 VDSL2 bandplan 997 B7-5 (25 kHz - 12 MHz). Upstream in red and downstream in blue.**



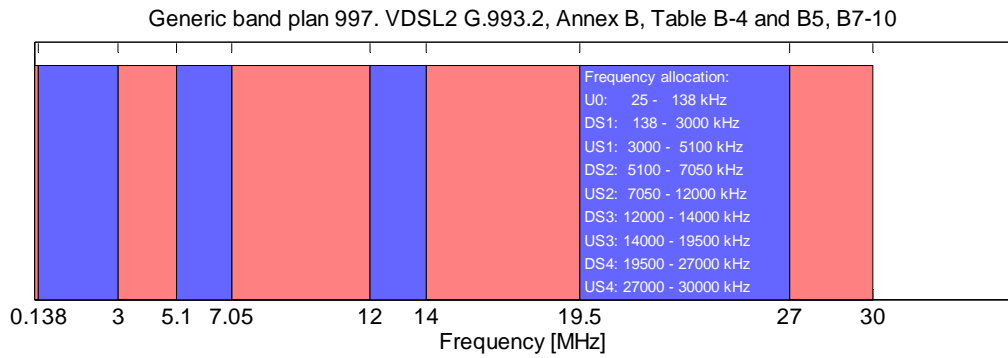
**Figure 3.13 Peak PSD limits for VDSL2 bandplan 997 B7-5 (25 kHz - 12 MHz). Upstream in red and downstream in blue.**



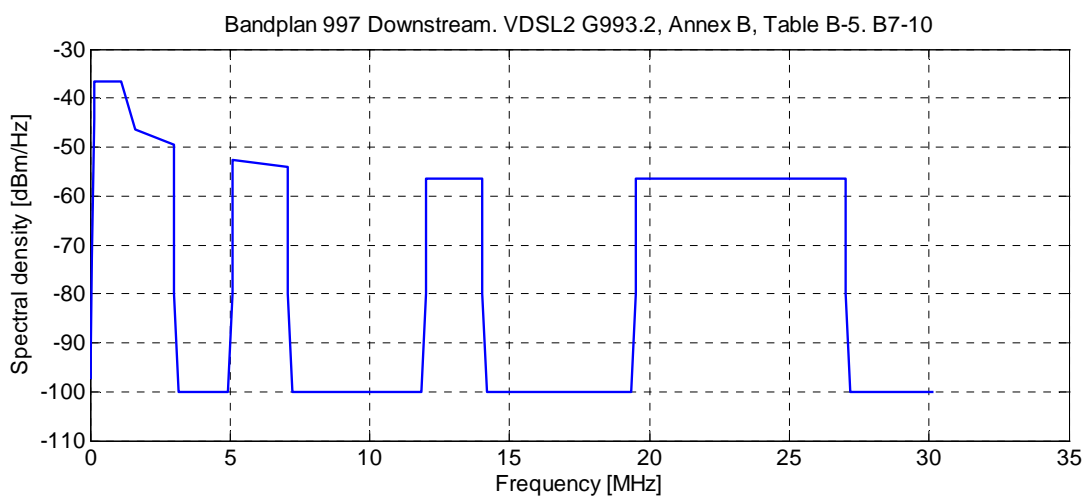
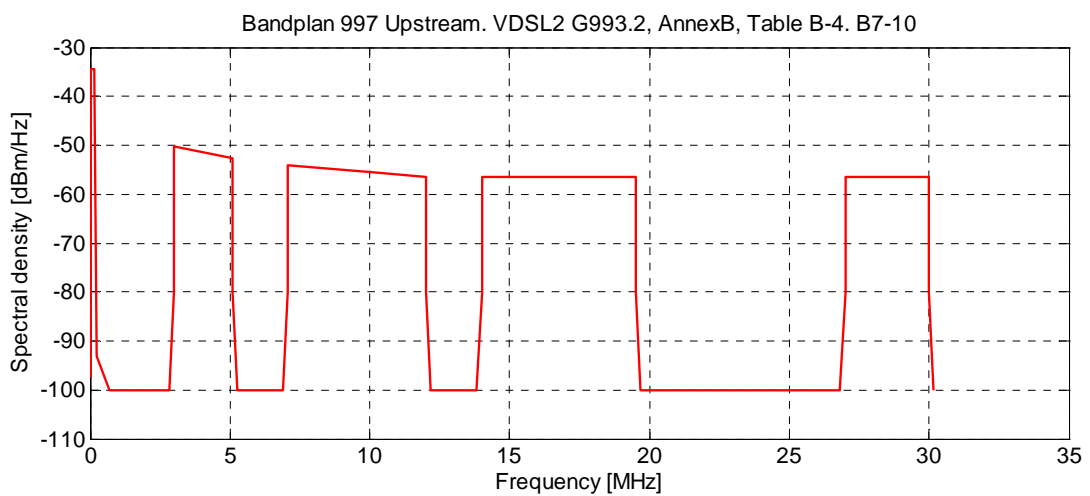
**Figure 3.14 VDSL2 bandplan 997, B7-9. (25 kHz - 17.664 MHz). Upstream in red and in downstream blue.**



**Figure 3.15 Peak PSD limits for VDSL2, bandplan 997, B7-9. (25 kHz - 17.664 MHz). Upstream in red and in downstream blue.**



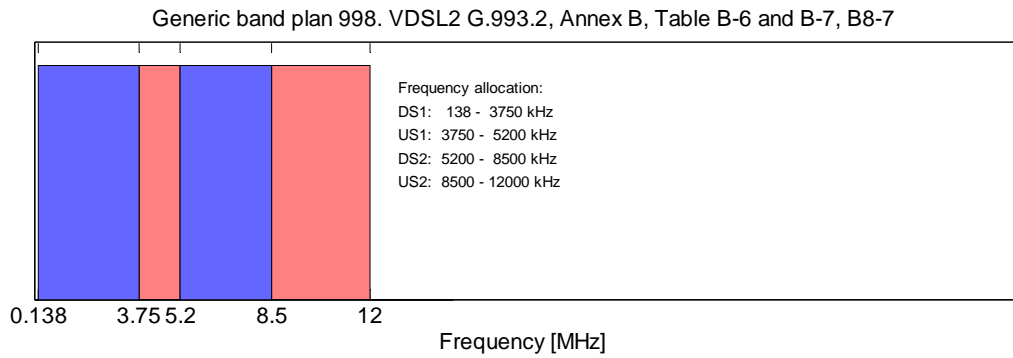
**Figure 3.16 VDSL2 bandplan 997, B7-10 (25 kHz - 30 MHz). Upstream in red and downstream in blue.**



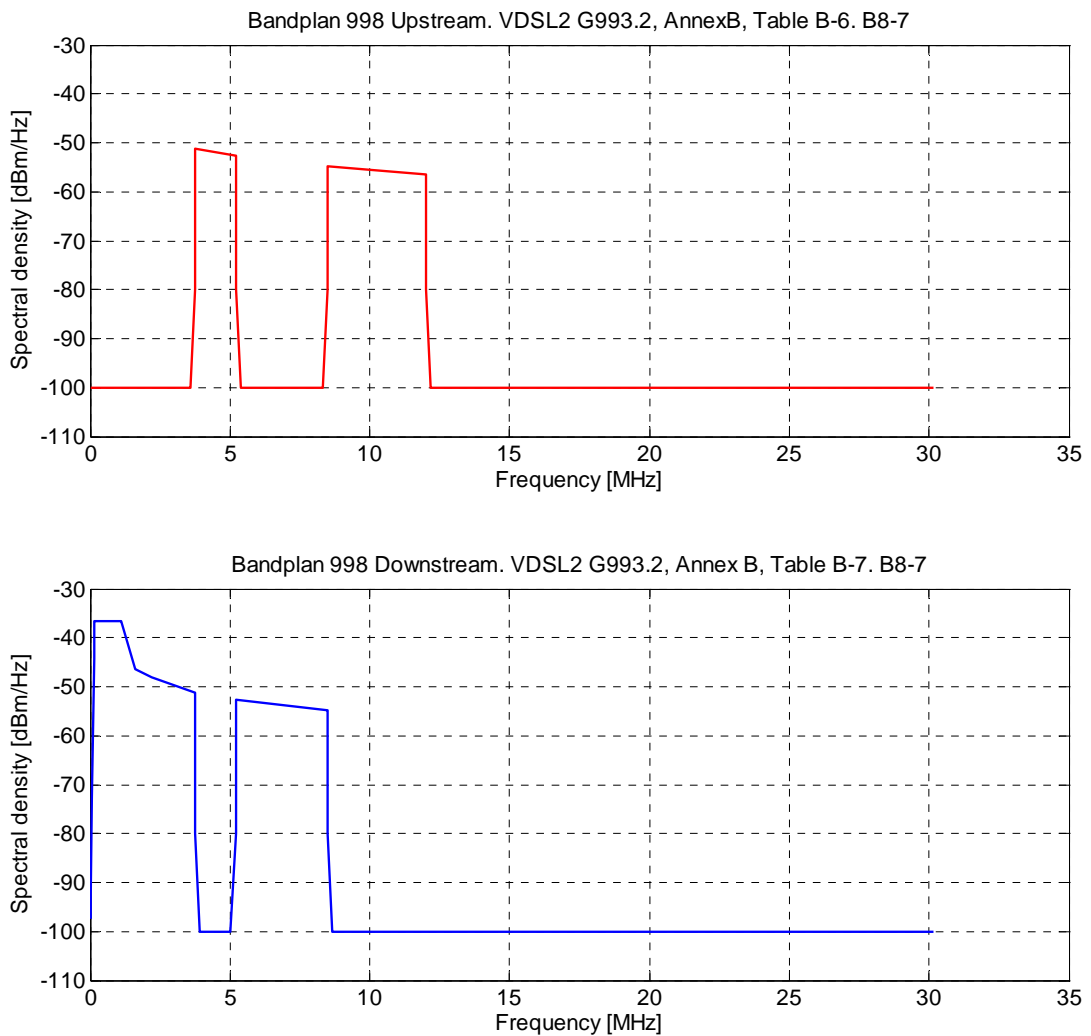
**Figure 3.17 Peak PSD limits for VDSL2 bandplan 997, B7-10 (25 kHz - 30 MHz). Upstream in red and downstream in blue.**



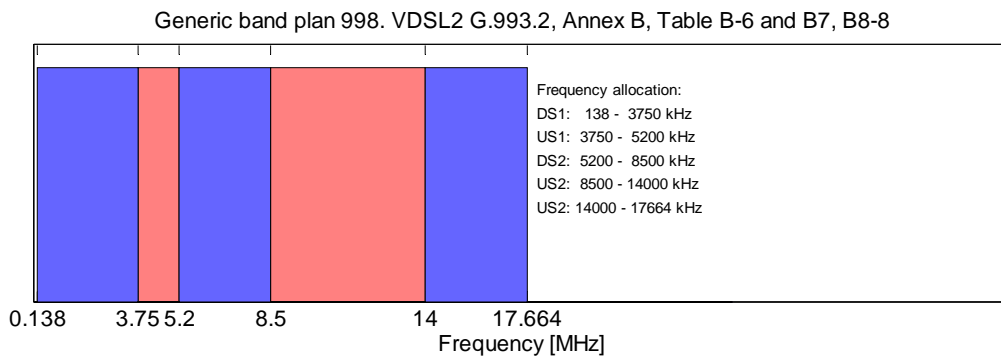
**3.4.3.2 Bandplan 998**



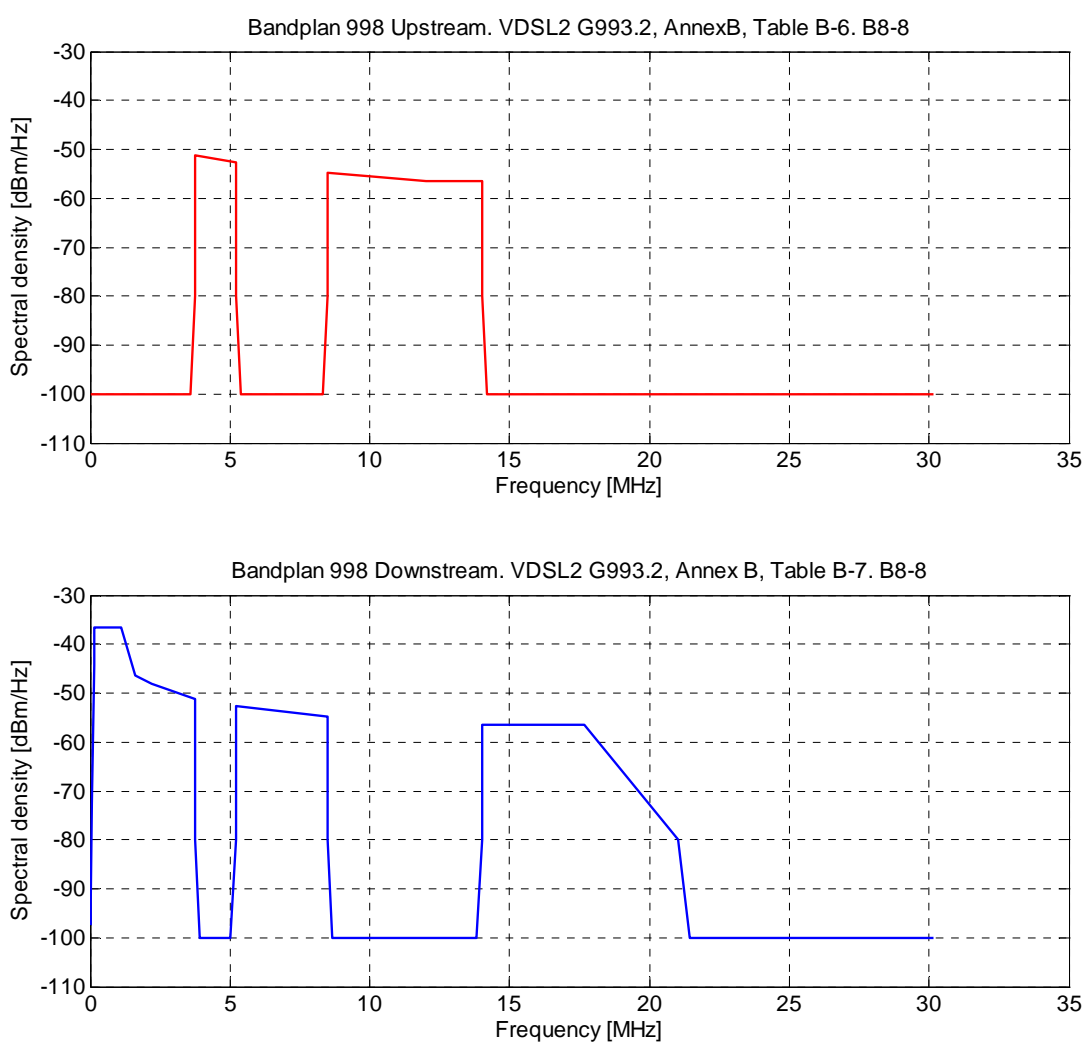
**Figure 3.18 VDSL2 bandplan 998, B8-7 (138 kHz - 12 MHz). Upstream in red and downstream in blue.**



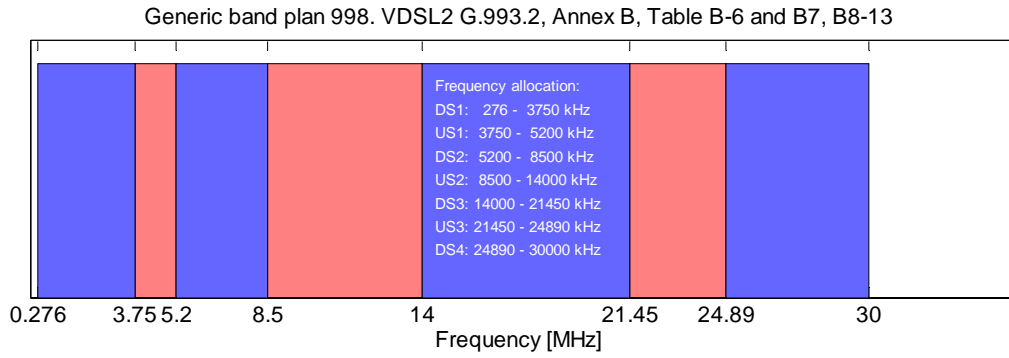
**Figure 3.19 Peak PSD limits for VDSL2 bandplan 998, B8-7 (138 kHz - 12 MHz). Upstream in red and downstream in blue.**



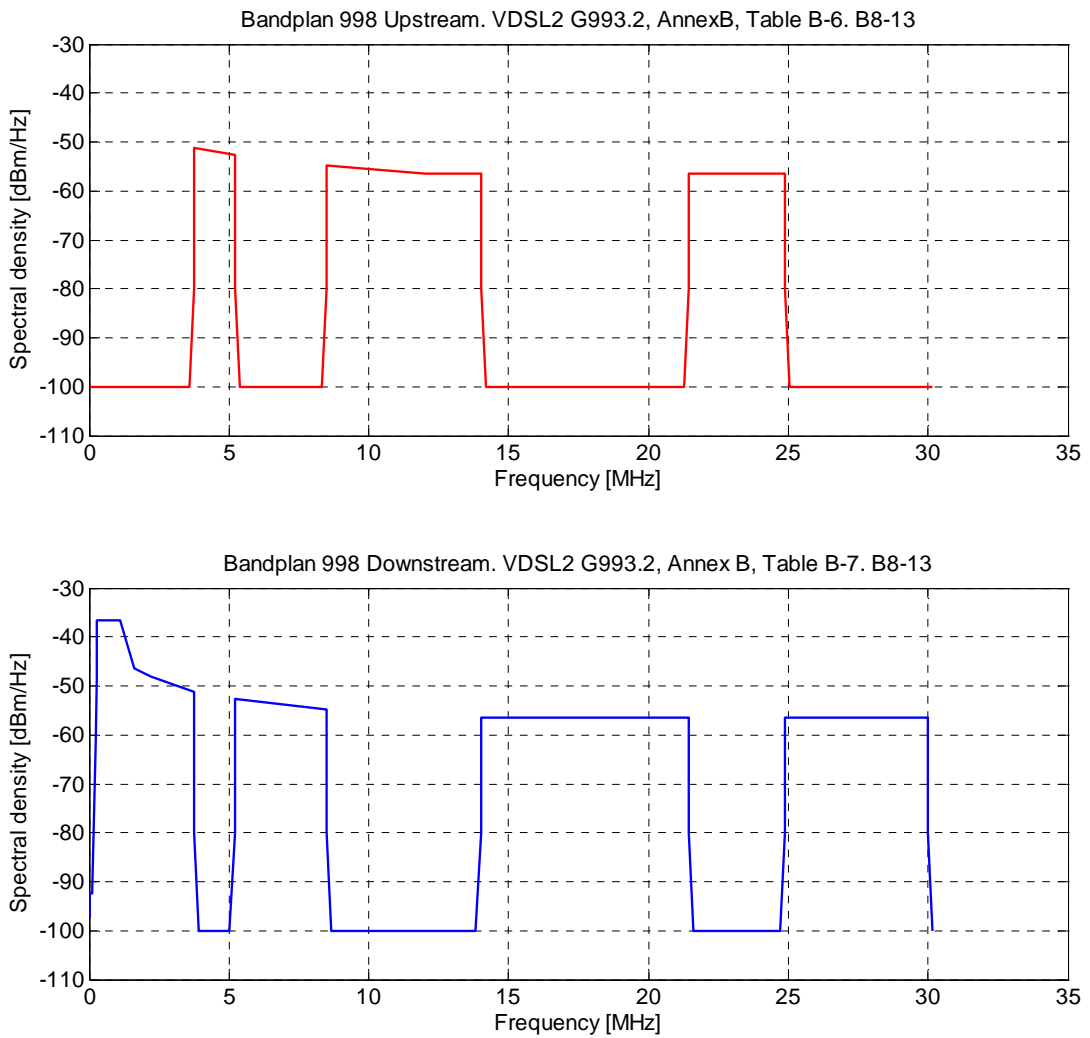
**Figure 3.20 VDSL2 bandplan 998, B8-8 (138 kHz - 17.664 MHz). Upstream in red and downstream in blue.**



**Figure 3.21 Peak PSD limits for VDSL2 bandplan 998, B8-8 (138 kHz - 17.664 MHz). Upstream in red and downstream in blue.**



**Figure 3.22 VDSL2 bandplan 998, B8-13 (276 kHz - 30 MHz). Upstream in red and downstream in blue.**



**Figure 3.23 Peak PSD limits for VDSL2 bandplan 998, B8-13 (276 kHz - 30 MHz). Upstream in red and downstream in blue.**



## 4 Simulation models

Two different types of simulation models has to be used for estimating the bitrate or reach of a transmission system; one for multicarrier systems like ADSL and VDSL, and another for single carrier systems.

### 4.1 Simulation model for multicarrier systems

The simulation model for multicarrier systems assumes adaptive modulation in each sub-band. All estimates are based upon signal to noise ratios additional margins. The signal to noise ratio is calculated from the spectra of the disturbed system and the different disturbing systems. The theoretical channel capacity in the frequency interval  $[fl, fh]$  is given by Shannon's channel capacity formula:

$$C_{sh} = \int_{fl}^{fh} \log_2 \left( 1 + \frac{S(f)}{N(f)} \right) df \quad (3)$$

$S(f)$  is signal power density at receiver input.

$N(f)$ : noise power density at receiver input.

A realistic estimate of the bitrate of a pair is obtained by:

$$R = \int_{fl}^{fh} k_{eff} \cdot \log_2 \left( 1 + \lambda \cdot \frac{S(f)}{N(f)} \right) df \quad (4)$$

$\lambda = 10^{\frac{m dB}{10}}$ , where  $m dB$  is the margin in dB, both safety margin and the distance in dB to Shannons capacity limit for the modulation method.

$k_{eff} \leq 1$  is the ratio between effective bitrate and transmitted bitrate, and takes into account overhead due to pilots, Reed-Solomon code, cyclic prefix etc.

It is assumed that the signal to noise ratio is constant across each sub-channel. Hence, the estimate of the bitrate in (4) of a pair may be replaced by a sum:

$$R = k_{eff} \cdot \Delta f \cdot \sum_{i=Nl}^{Nh} \log_2 \left( 1 + \lambda \cdot \frac{S(f_i)}{N(f_i)} \right) \quad (5)$$

$Nl$  and  $Nh$  are the numbers of the lowest and highest sub-channel respectively.

$\Delta f$  is the frequency width of a sub-channel.

$f_i$  is the centre frequency of sub-channel no.  $i$ .

These calculations are carried out by means of the MATLAB based computer program DSLsim.

### 4.2 Simulation model for single carrier systems

SHDSL systems have been simulated using different modules from the MATLAB based simulation program PSIM4. A short description of the model is given below.

Modulation methods: Randomly generated 16-PAM or 32-PAM symbols

Transmitter filter: Square pulses + a Butterworth filter.

Channel: The channel model described in Section 3.2.1.

Background noise: ETSI noise according to Section 3.2.4.

NEXT noise: NEXT from HDSL, SHDSL, and ADSL is modelled in accordance with the crosstalk model in Section 3.2.2.

FEXT noise: NEXT is assumed to be stronger than FEXT, so that FEXT has been neglected here.

Receiver: Ideal linear equalizer that generates an overall Cosine Rolloff channel with 50% excess bandwidth.

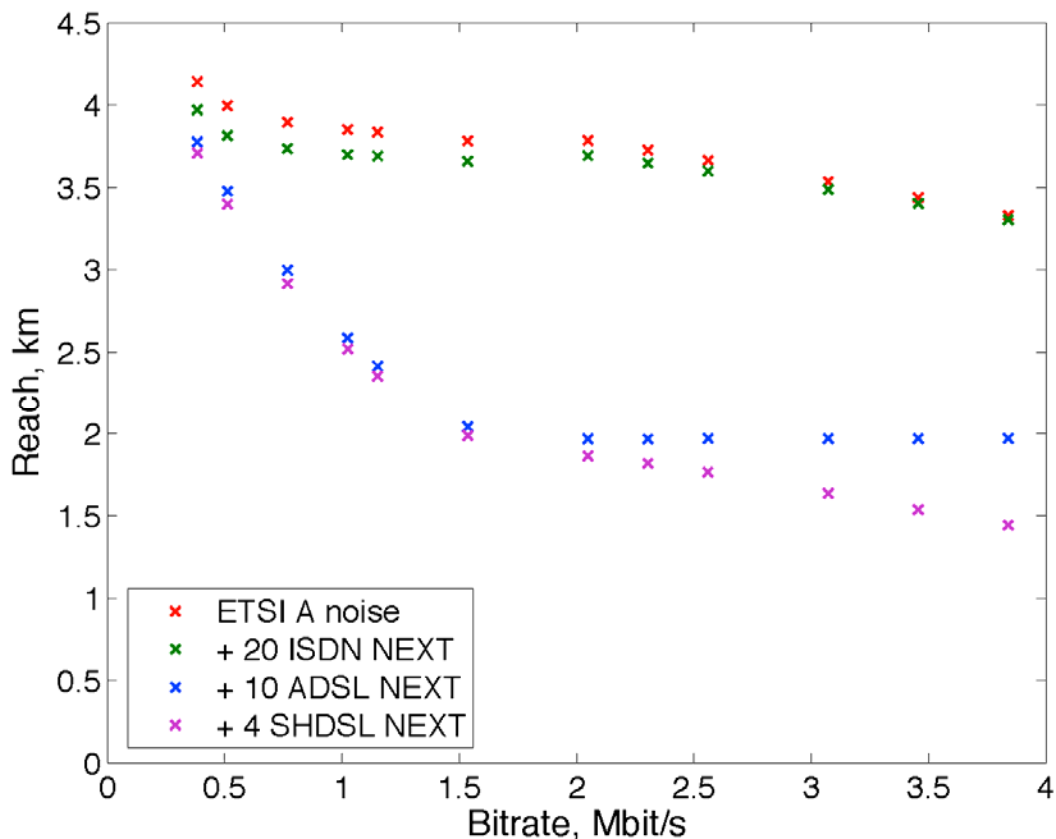
Calculation of maximum reach: The length of the cable is calculated so that a specified signal to noise ratio is obtained in the detection instant. This signal to noise ratio corresponds to a desired bit error rate after decoding the trellis code.

## 5 Simulation results for SHDSL

The performance of SHDSL systems has been calculated under the assumption that all transmission systems are terminated in the local exchange. In this situation, NEXT will be much stronger than FEXT, so that FEXT has been neglected. Only the upstream direction of SHDSL has been considered because it is subject to the strongest interference. Downstream ADSL has both a wider frequency band and contains higher frequencies than the upstream direction, and this generates the critical interference via NEXT coupling. ETSI noise type A plus NEXT from ISDN has been used as background noise in the simulations. The main noise is NEXT from a variable number of ADSL and SHDSL systems.

One of the most critical noise components in ADSL systems is crosstalk from SHDSL. This noise depends strongly on the loop length of the SHDSL systems. Hence, one of the most important objectives of this section is to calculate the maximum reach of SHDSL in order to use the results in the analysis of ADSL.

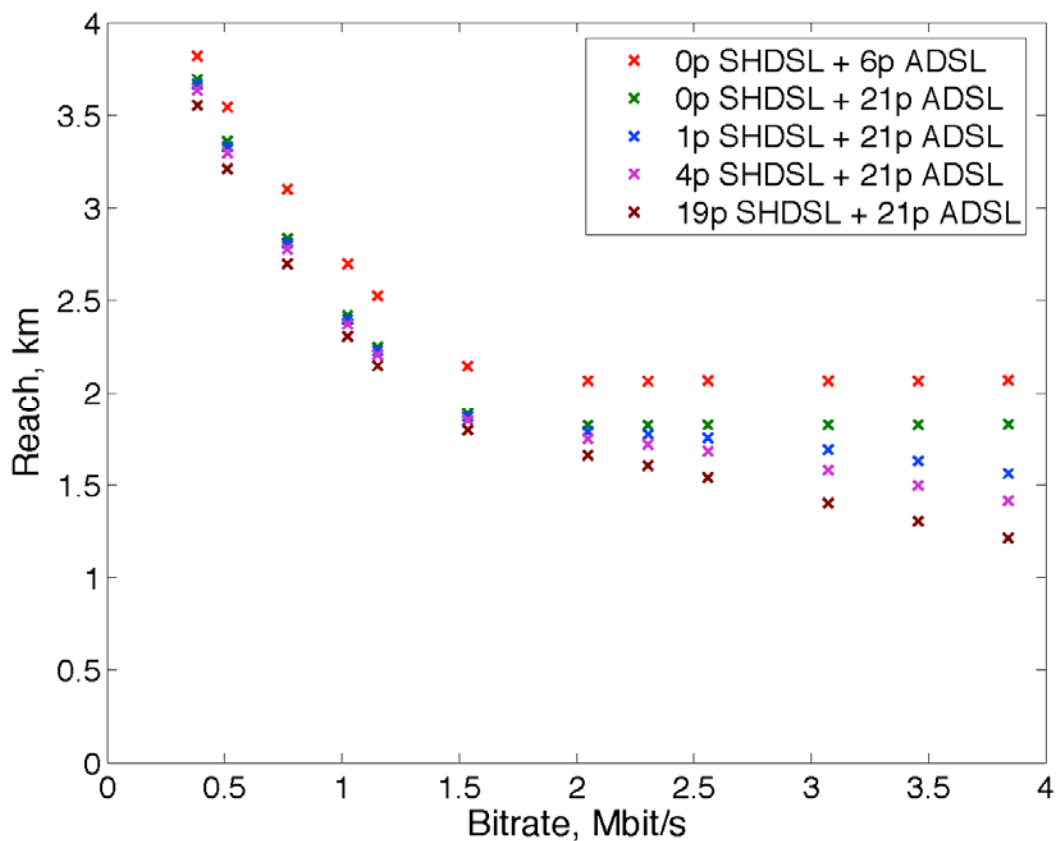
### 5.1 SHDSL with 16-PAM modulation



**Figure 5.1** Maximum reach of SHDSL 16-PAM for different noise situations.

Figure 5.1 shows the reach of the standard type of SHDSL system with 16-PAM modulation both for the currently used bitrates up to 2.304 Mbit/s and the extended bitrates up to 3.848 Mbit/s. The red points show results with ETSI noise A only. Adding NEXT from 20 ISDN systems gives the green points. By also adding NEXT from 10 ADSL systems gives the blue points. Finally by adding the an extra interference from 4 SHDSL systems with the same rate as the disturbing systems will give the purple points. This demonstrates that the most important noise components in SHDSL are NEXT from ADSL and SHDSL.

Figure 5.2 show the reach of SHDSL with 16-PAM modulation and a variable number of disturbing SHDSL and ADSL systems. The background noise is ETSI noise model A plus NEXT from 20 ISDN systems.

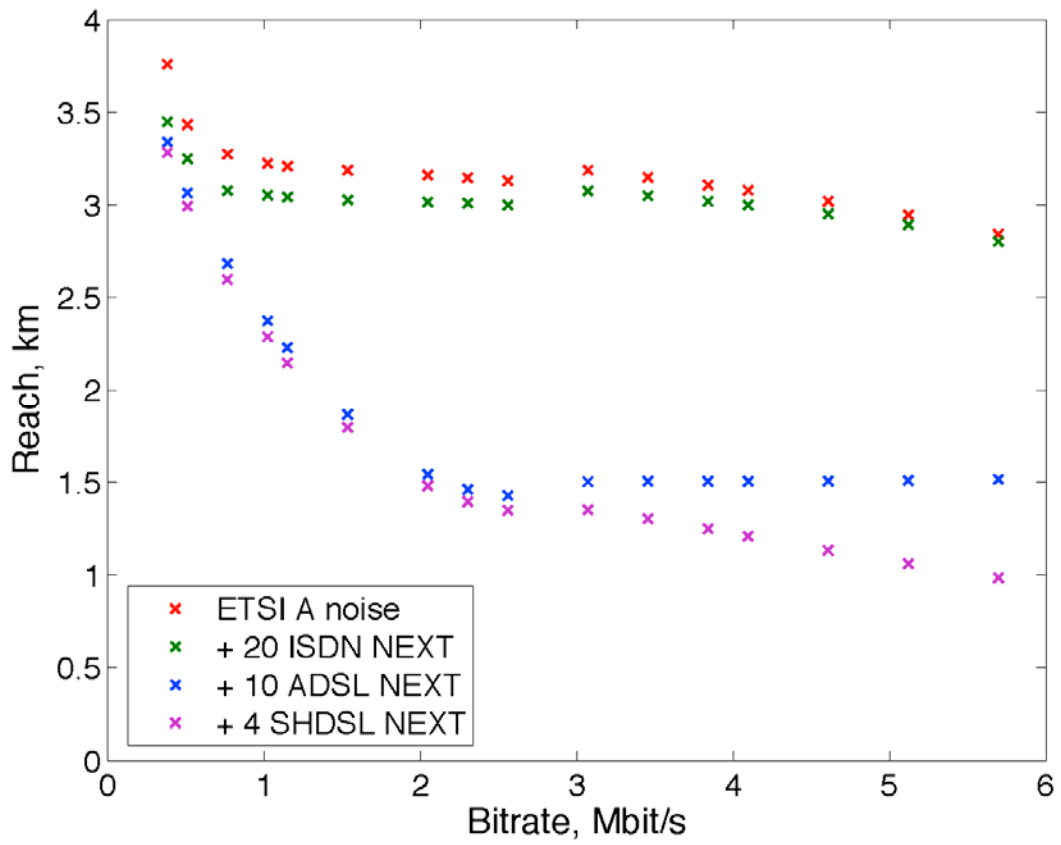


**Figure 5.2 Maximum reach of SHDSL 16-PAM for crosstalk from ADSL and SHDSL.**

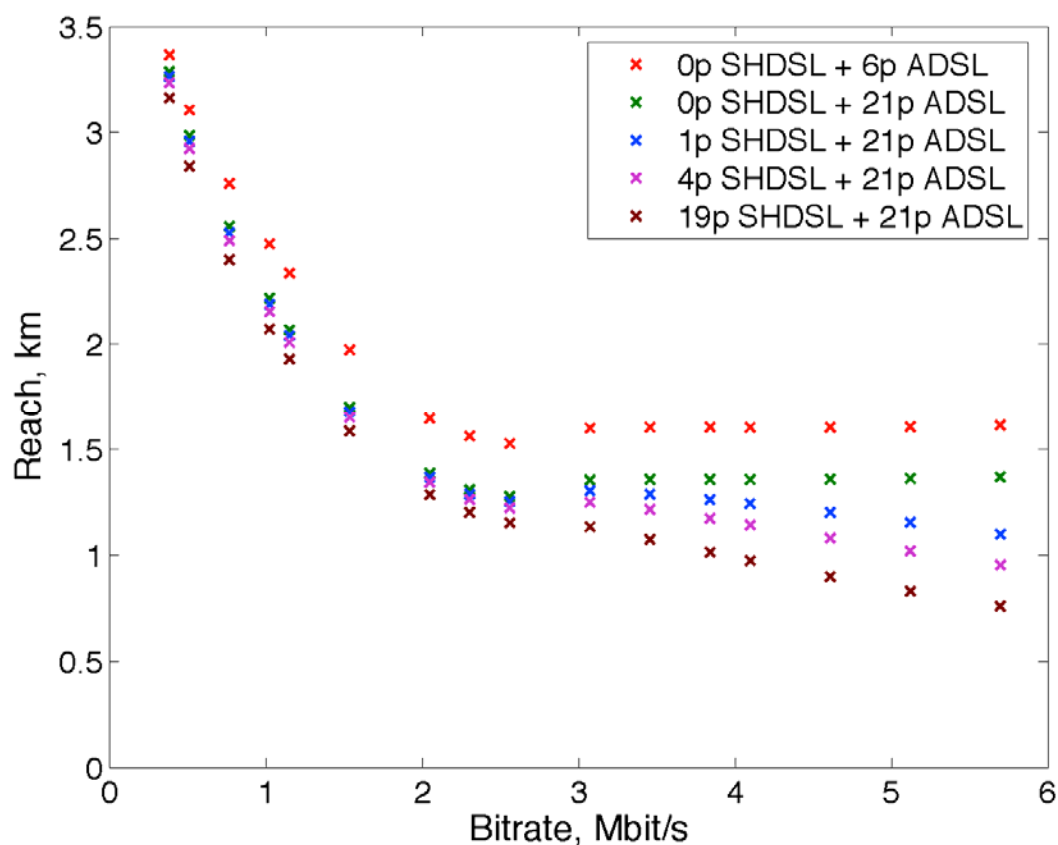
## 5.2 SHDSL with 32-PAM modulation

Figure 5.3 and Figure 5.4 show the maximum reach for SHDSL with 32-PAM modulation under the same assumptions as presented in Section 5.1 for 16-PAM.





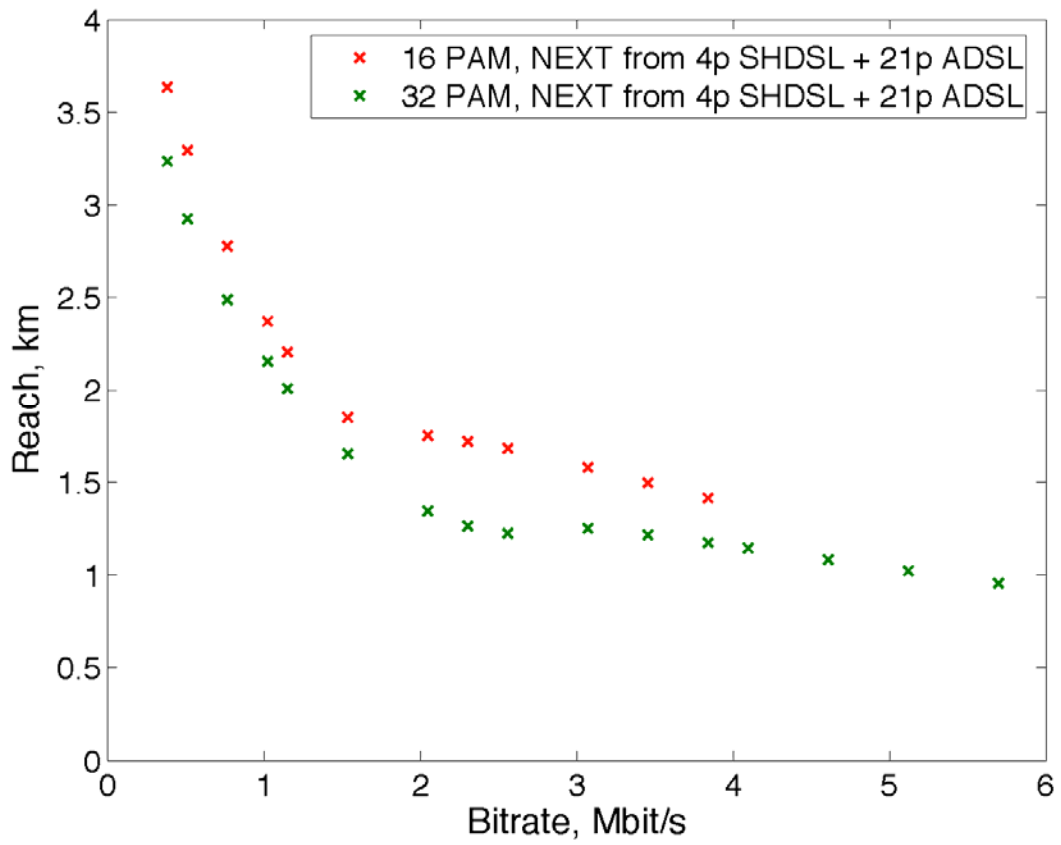
**Figure 5.3** Maximum reach of SHDSL 32-PAM for different noise situations.



**Figure 5.4** Maximum reach of SHDSL 32-PAM for crosstalk from ADSL and SHDSL.

### 5.3 Comparison of SHDSL systems using 16-PAM and 32-PAM modulation

Figure 5.5 shows the maximum reach for SHDSL with 16-PAM and 32-PAM modulation for a typical case of interference. This demonstrates that 16-PAM will always give a longer reach. The main advantage of 32-PAM is that it generates less interference for a given bitrate.



**Figure 5.5 Maximum reach of SHDSL 16-PAM and 32-PAM.**



## 6 Simulation results for ADSL with all DSLAMs in the local exchange

### 6.1 Simple illustrations of some important interference situations in ADSL systems

This section shows the potential bitrate of ADSL systems for some typical interference situations, both for downstream and for upstream transmission. For downstream transmission in the Norwegian access network there will be two main cases, ADSL (the ADSL2 standard) with 1.1 MHz bandwidth presented in Figure 6.1 and ADSL2+ with 2.2 MHz bandwidth presented in Figure 6.2. For upstream ADSL there will also be two main cases for the Norwegian network, ADSL over ISDN presented in Figure 6.3 and All Digital ADSL is presented in Figure 6.4.

Figure 6.1 shows the bitrate of downstream ADSL. The upper solid curve is for ETSI noise type A as the only disturbance, and is the performance of a purely attenuation limited system. When there are multiple ADSL systems in the same cable, there will be crosstalk from other ADSL systems. The dashed line shows the performance of a typical situation with 20 ADSL disturbers (21 systems). There is a significant reduction in bitrate compared to the case with ETSI noise only.

In addition, there may be SHDSL systems in the cable. The dash-dotted curve shows the bitrate when there are 5 SHDSL systems of today's type with 2.3 Mbit/s in addition to the 20 disturbing ADSL systems. The degradation due to the SHDSL systems is quite marginal, with a maximum reduction in bitrate of approximately 4%.

If SHDSL systems in accordance with Annex G are allowed there will be a further degradation of performance. The dotted line shows the bitrate for 5 disturbing systems carrying 5.7 Mbit/s SHDSL in addition to all previously assumed disturbers. Adding 5.7 Mbit/s SHDSL systems causes a moderate reduction in bitrate, and the maximum additional reduction is approximately 7%. This demonstrates that permitting SHDSL Annex G will not cause a dramatic reduction in the performance of ADSL.

The lower solid curve shows the performance for additional crosstalk from E1-systems with repeaters for the case of 5 disturbers. This shows that E1-systems will dramatically reduce the bitrate and hence should be avoided.

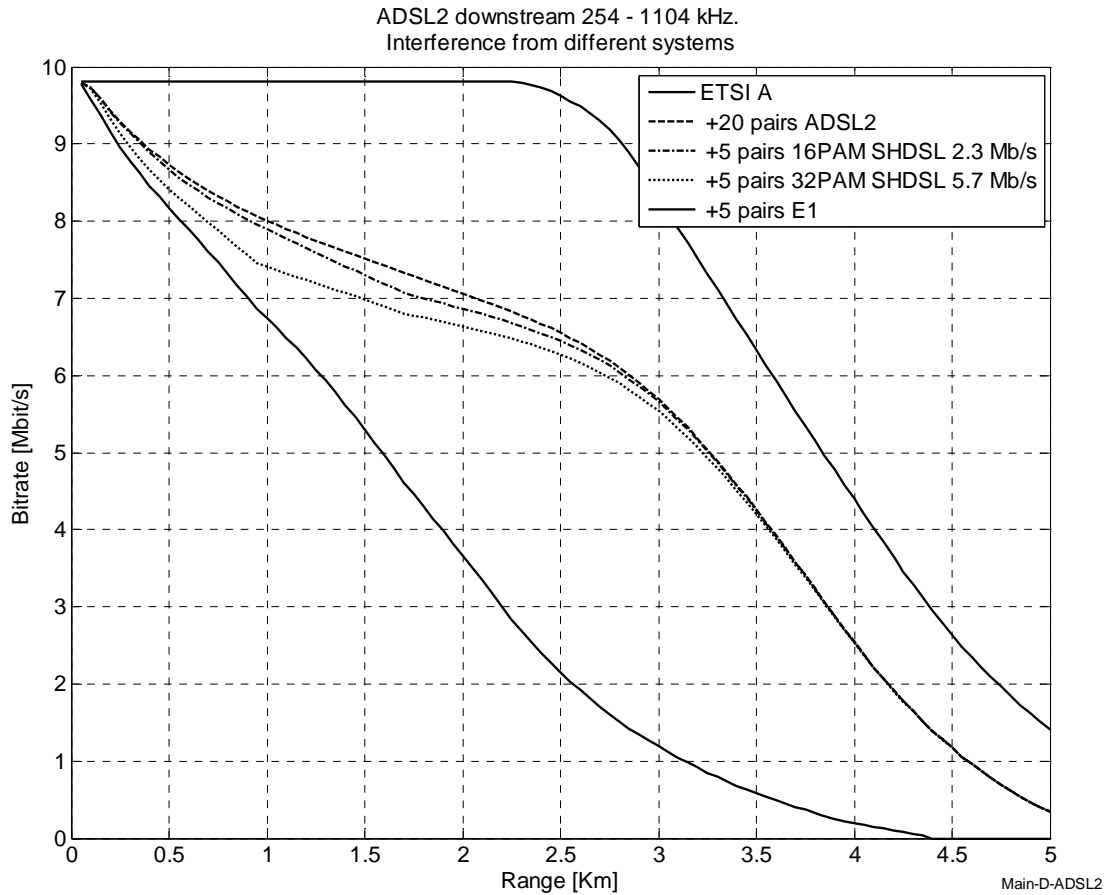
Figure 6.2 shows results for downstream transmission for the ADSL2+ system for the same crosstalk situations as in Figure 6.1. The extended frequency range of ADSL2+ leads to significantly higher bitrates, but the relative differences between the different cases are similar to the differences in Figure 6.1. The main difference from the above comments is that the degradations caused by SHDSL and SHDSL Annex G are smaller for ADSL2+. The reason is that SHDSL has less spectral overlap with ADSL2+ than with ADSL.

Figure 6.3 shows the potential bitrate of upstream transmission for ADSL (ADSL or ADSL2+) over ISDN. The upper solid curve is for ETSI noise type A only. Adding crosstalk from 20 ADSL systems represents a more realistic situation. The result is shown by the broken line. The figure shows that crosstalk from ADSL leads to a significant reduction in performance compared to the ideal case with ETSI noise only.

The dash-dotted curve show the performance if crosstalk from SHDSL systems is added. This demonstrates that NEXT from SHDSL and other relevant transmission systems has only a minor effect on upstream ADSL.

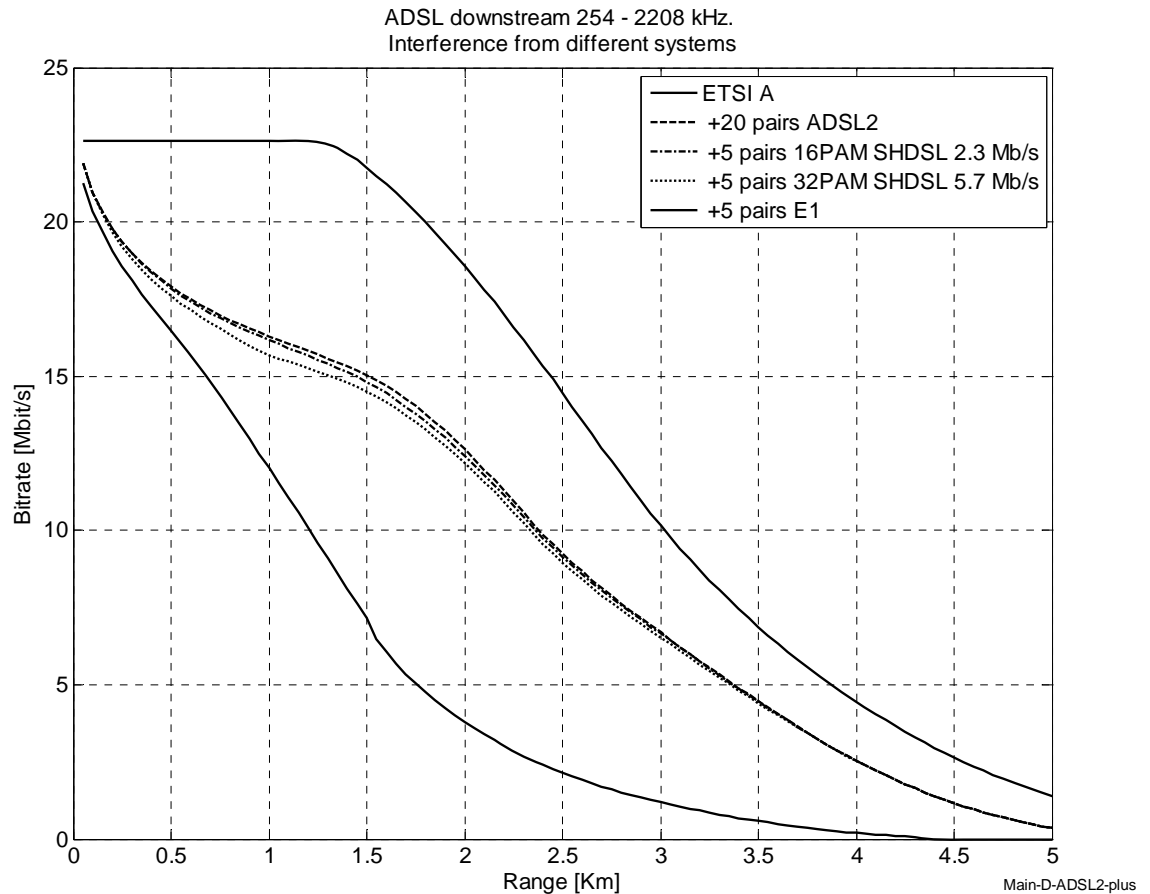
Figure 6.4 shows the potential bitrate of upstream transmission for All Digital ADSL (ADSL or ADSL2+). The results are similar to Figure 6.3. Just as in Figure 6.3, there is a significant degradation caused by crosstalk from ADSL compared to ETSI noise only. The dash-dotted curve shows that adding NEXT from 20 ISDN systems will only have a minor influence, despite a significant overlap in frequency between the two systems. The explanation is that the crosstalk

coupling is weak in the corresponding frequency range. The dotted curve gives the performance when additional crosstalk from SHDSL is introduced, and shows that SHDSL will have only a marginal influence.



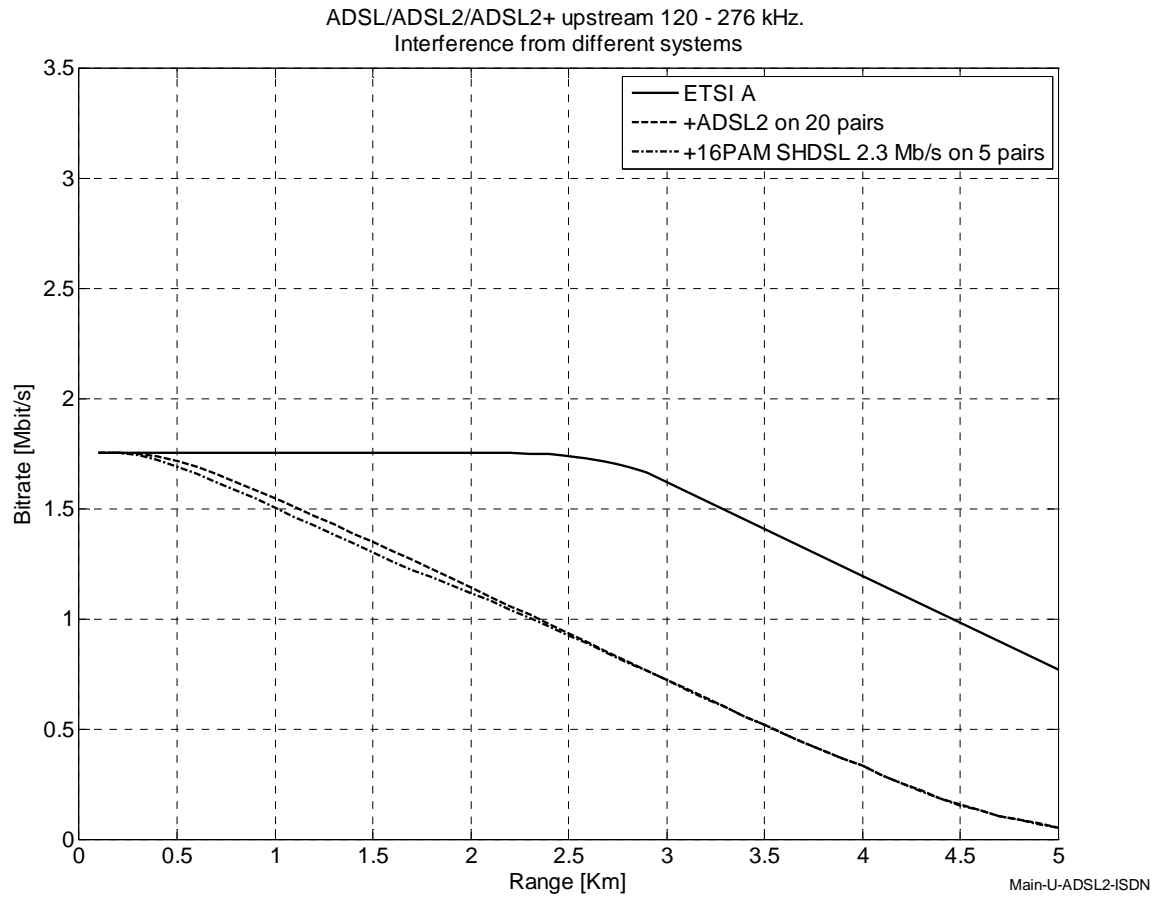
**Figure 6.1 Downstream ADSL (254 - 1104 kHz). Interference from:**

- 1) ETSI A
- 2) ETSI A + ADSL (FEXT and NEXT),
- 3) ETSI A + ADSL (FEXT and NEXT) + SHDSL 16-PAM 2.3 Mb/s (NEXT)
- 4) ETSI A + ADSL (FEXT and NEXT) + SHDSL 16-PAM 2.3 Mb/s (NEXT) + 32-PAM SHDSL 5.7 Mb/s (NEXT)
- 5) ETSI A + ADSL (FEXT and NEXT) + SHDSL 16-PAM 2.3 Mb/s (NEXT) + 32-PAM SHDSL 5.7 Mb/s (NEXT) + E1 (NEXT)



**Figure 6.2. Downstream ADSL2+ (254 - 2008 kHz). Interference from:**

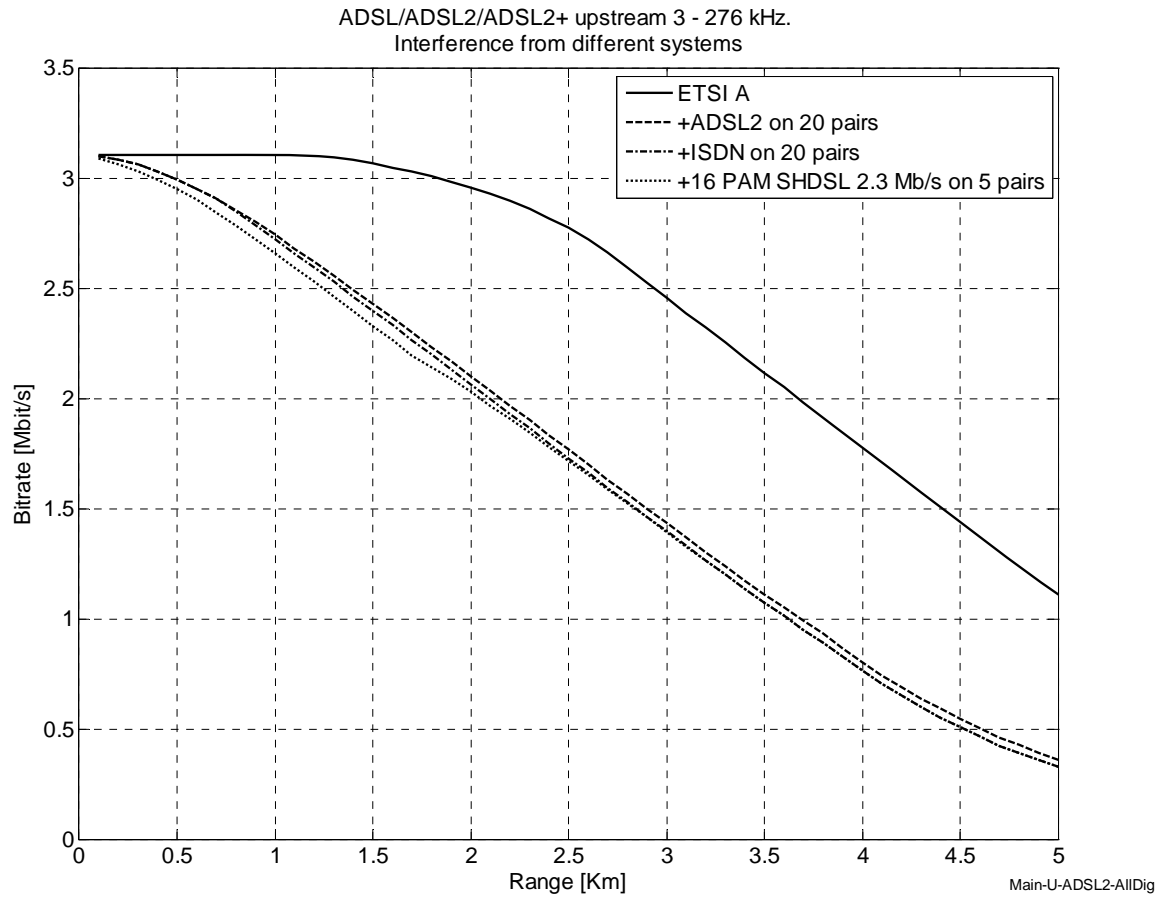
- 1) ETSI A
- 2) ETSI A + ADSL (FEXT and NEXT),
- 3) ETSI A + ADSL (FEXT and NEXT) + SHDSL 16-PAM 2.3 Mb/s (NEXT)
- 4) ETSI A + ADSL (FEXT and NEXT) + SHDSL 16-PAM 2.3 Mb/s (NEXT) + 32-PAM SHDSL 5.7 Mb/s (NEXT)
- 5) ETSI A + ADSL (FEXT and NEXT) + SHDSL 16-PAM 2.3 Mb/s (NEXT) + 32-PAM SHDSL 5.7 Mb/s (NEXT) + E1 (NEXT)



**Figure 6.3 Upstream ADSL over ISDN (120 - 276 kHz). Interference from:**

- 1) ETSI A
- 2) ETSI A + ADSL (FEXT and NEXT),
- 3) ETSI A + ADSL (FEXT and NEXT) + ISDN on 20 pairs (NEXT)
- 4) ETSI A + ADSL (FEXT and NEXT) + ISDN on 20 pairs (NEXT) + SHDSL 16-PAM 2.3 Mb/s on 5 pairs (NEXT)





**Figure 6.4. Upstream ADSL All Digital (3 - 276 kHz). Interference from:**

- 1) ETSI A
- 2) ETSI A + ADSL (FEXT and NEXT),
- 3) ETSI A + ADSL (FEXT and NEXT) + ISDN on 20 pairs (NEXT)
- 4) ETSI A + ADSL (FEXT and NEXT) + ISDN on 20 pairs (NEXT) + SHDSL 16-PAM 2.3 Mb/s on 5 pairs (NEXT)

## 6.2 Downstream ADSL (254 – 1104 kHz) with all DSLAMs in the local exchange

This section shows the potential bitrate of downstream ADSL (the ADSL2 standard) for different numbers of disturbing systems and for all major interfering systems in the Norwegian access network.

Figure 6.7 shows the performance of an ADSL system in a cable with ADSL systems only and with ETSI noise type A as background noise. The potential bitrate is significantly reduced by introducing only one disturbing ADSL system, and adding more ADSL systems causes a further reduction in bitrate.

Figure 6.9 shows the performance for an ADSL system disturbed by crosstalk from 5 SHDSL systems with 16-PAM modulation and different bitrates. Background noise is ETSI noise type A plus crosstalk from 20 ISDN systems and 20 ADSL systems. The results show that SHDSL causes only a marginal degradation up to 2.3 Mbit/s, the highest bitrate that is allowed today. The degradation for higher bitrates is larger, but still modest. Figure 6.11 shows the performance for additional crosstalk from SHDSL 16-PAM systems with maximum bitrate, 3.85 Mbit/s, and different numbers of disturbers. The reduction in bitrate is in the order of 15%, almost independent of the number of disturbers. The reason is that the reach of the SHDSL systems decreases when the number of systems increases.

The simulations of Section 6.2.2 are repeated in Section 6.2.3 with 32-PAM SHDSL instead of 16-PAM. The results for 32-PAM are in close correspondence with the results for 16-PAM, but the largest reductions in bitrate for 32-PAM are somewhat smaller and in the order of 10%.

Figure 6.17, Figure 6.18 and Figure 6.19 show the potential bitrate of downstream ADSL for crosstalk from HDSL systems without repeaters. It is assumed a background noise consisting of ETSI noise type A plus crosstalk from 20 ISDN systems and 20 ADSL systems. The results show that the largest reduction in bitrate is approximately 8% for One-pair HDSL. The reduction is much smaller for two-pair systems and almost negligible for three-pair systems. This is due to the reduced bandwidth in two- and three-pair systems. The results are in close correspondence with the results for SHDSL.

Figure 6.21 and Figure 6.22 show the potential bitrate of downstream ADSL for crosstalk from Two-pair HDSL and Three-pair HDSL with repeaters (repeaters are not used in One-pair HDSL). The degradation is almost negligible for three-pair systems. For two-pair systems the degradation is small for short loops, and the HDSL systems mainly cause a reduced reach of the ADSL system. The reduction in reach is approximately 10% for 5 disturbing pairs with Two-pair HDSL.

Figure 6.24 show the potential bitrate of downstream ADSL for crosstalk from E1-systems with repeaters under the same assumptions as above. This shows that there will be a large degradation in bitrate of the ADSL systems for only one E1-system. This shows that E1-systems should be avoided (removed) in cables used for ADSL.

A current critical issue for ADSL is the additional degradation that will be caused by introducing SHDSL Annex G. This is summarized in Table 6.1 and Figure 6.5. The reference system is an ADSL system without crosstalk from HDSL or SHDSL. The background noise is ETSI noise A plus crosstalk from 20 ADSL systems and 20 ISDN systems. The table shows the degradation in percent for downstream ADSL caused by additional crosstalk from each of the following systems:

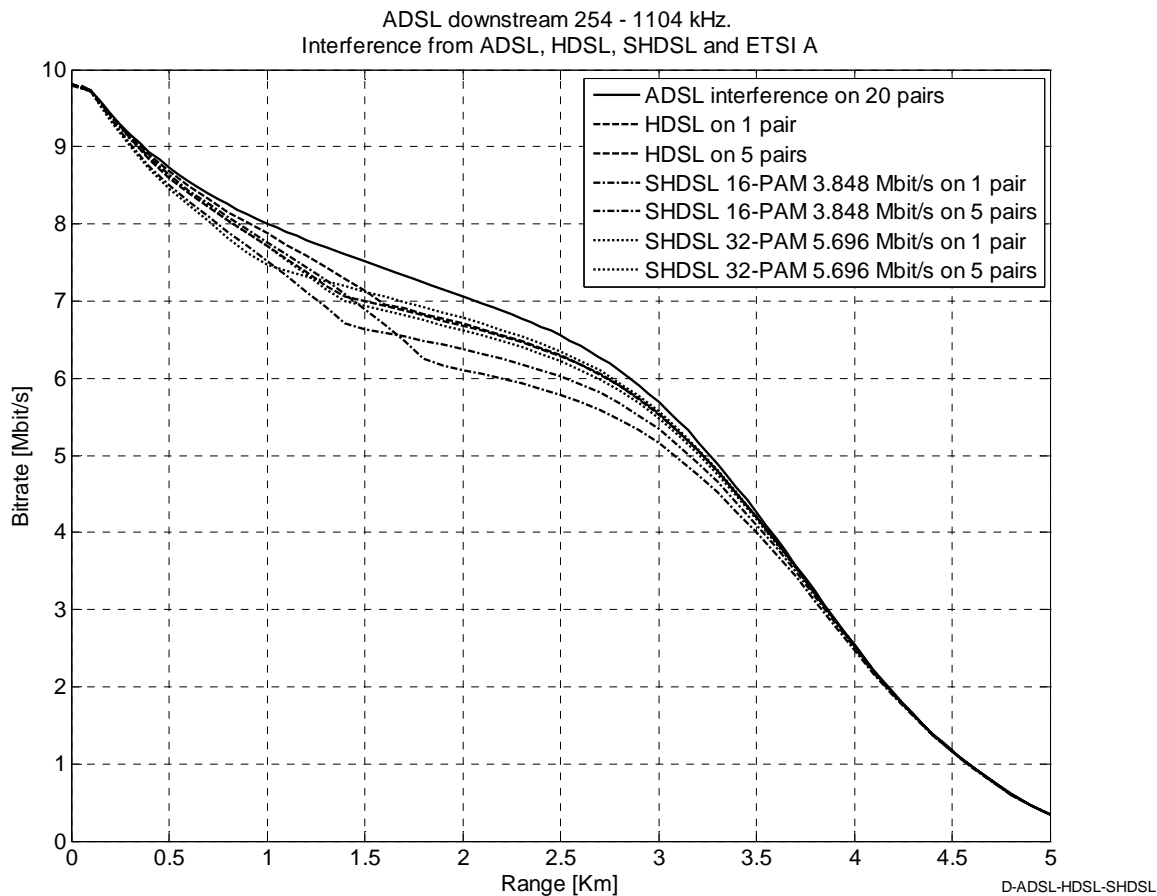
- One-pair HDSL
- Current SHDSL, 2.3 Mbit/s, 16-PAM
- SHDSL, 3.85 Mbit/s, 16-PAM, Annex G
- SHDSL, 5.7 Mbit/s, 32-PAM, Annex G

For all cases the results show the worst degradation caused by 1 to 5 disturbing HDSL or SHDSL systems.

**Table 6.1 Degradation in bitrate of downstream ADSL due to different versions of SHDSL and HDSL.**

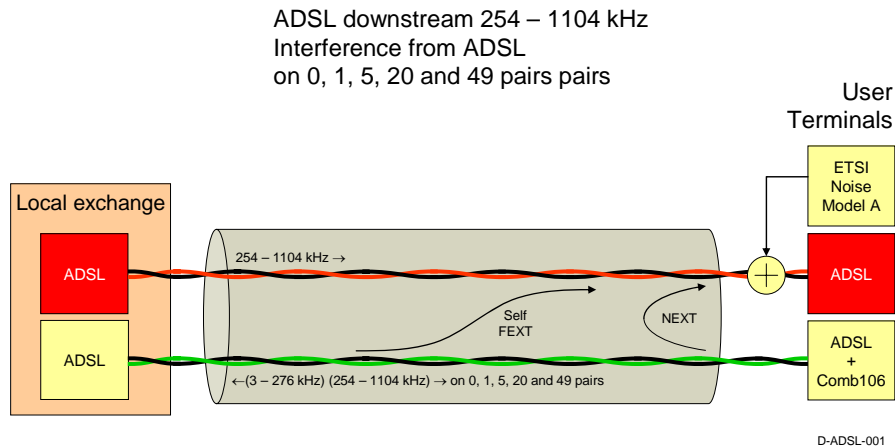
Reach of ADSL system:	1.0 km	1.5 km	2.0 km	2.5 km	3.0 km
ADSL bitrate without HDSL and SHDSL (reference)	8.0 Mbit/s	7.5 Mbit/s	7.1 Mbit/s	6.6 Mbit/s	5.6 Mbit/s
Reduction in bitrate for ADSL due to One-pair HDSL	4%	7%	6%	5%	4%
Reduction in bitrate for ADSL due to 2.3 Mbit/s SHDSL	1%	3%	3%	2%	1%
Reduction in bitrate for ADSL due to 3.85 Mbit/s SHDSL	6%	12%	13%	12%	10%
Reduction in bitrate for ADSL due to 5.7 Mbit/s SHDSL	7%	7%	6%	6%	4%
Reduction for 3.85 Mbit/s SHDSL compared to One-pair HDSL	2%	5%	7%	7%	6%
Reduction for 5.7 Mbit/s SHDSL compared to One-pair HDSL	3%	0%	0%	1%	0%

The current HDSL or SHDSL system that causes the largest degradations is One-pair HDSL. Hence the results for the systems introduced in SHDSL Annex G are compared to One-pair HDSL. The results show that the 5.7 Mbit/s SHDSL system causes almost the same degradation as HDSL. The worst degradation is caused by 3.85 Mbit/s SHDSL with 16-PAM modulation. The reason for this is that the 3.85 Mbit/s system has a significantly longer reach than the 5.7 Mbit/s system, so that it causes a more severe NEXT. This means that SHDSL Annex G systems will cause maximum 7% larger degradation of downstream ADSL than One-pair HDSL.

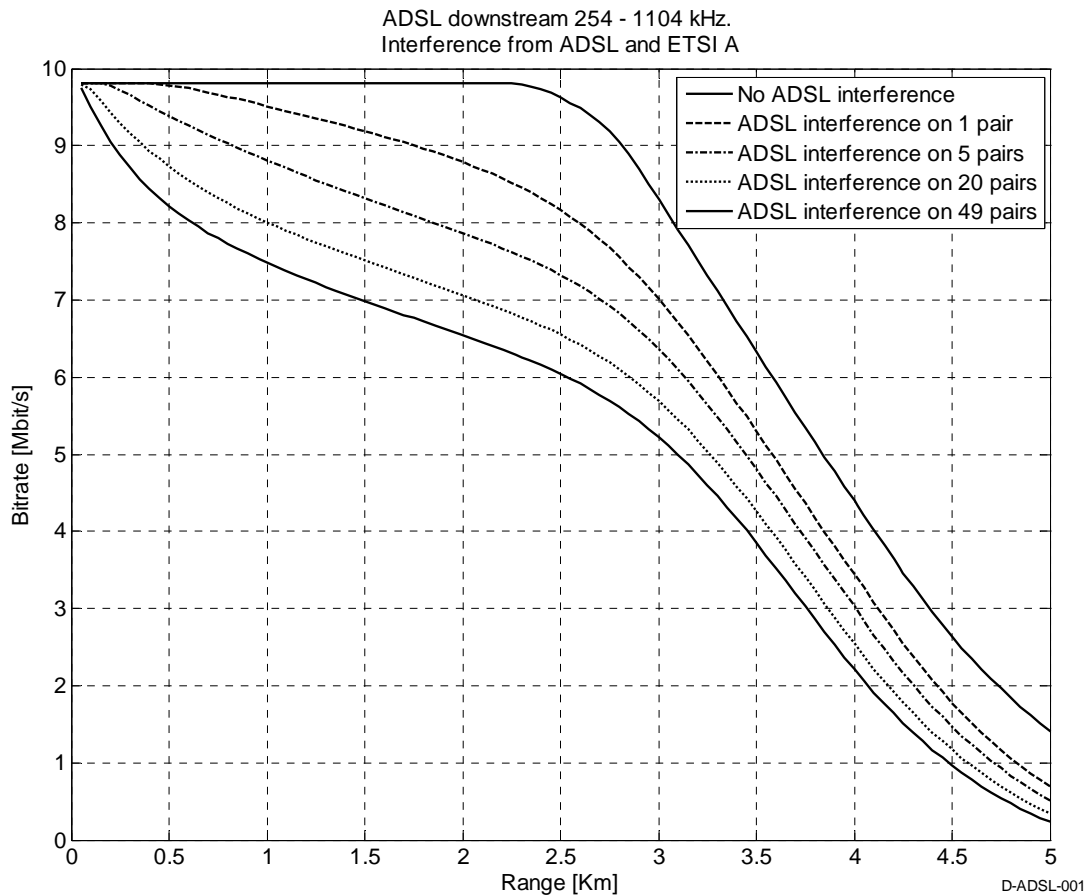


**Figure 6.5 Downstream ADSL. Interference from ADSL, One-pair HDSL, SHDSL 16-PAM 3.848 Mbit/s and SHDSL 32-PAM 5.696 Mbit/s.**

**6.2.1 Downstream ADSL with interference from ADSL systems**



**Figure 6.6 Downstream ADSL 254 - 1104 kHz. Interference from ADSL2.**



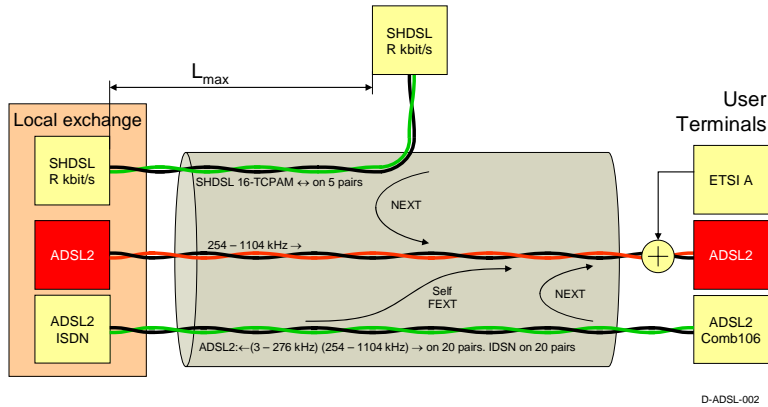
**Figure 6.7 Downstream ADSL 276 – 1104 kHz.**

**6.2.2 Downstream ADSL with interference from SHDSL 16-PAM**

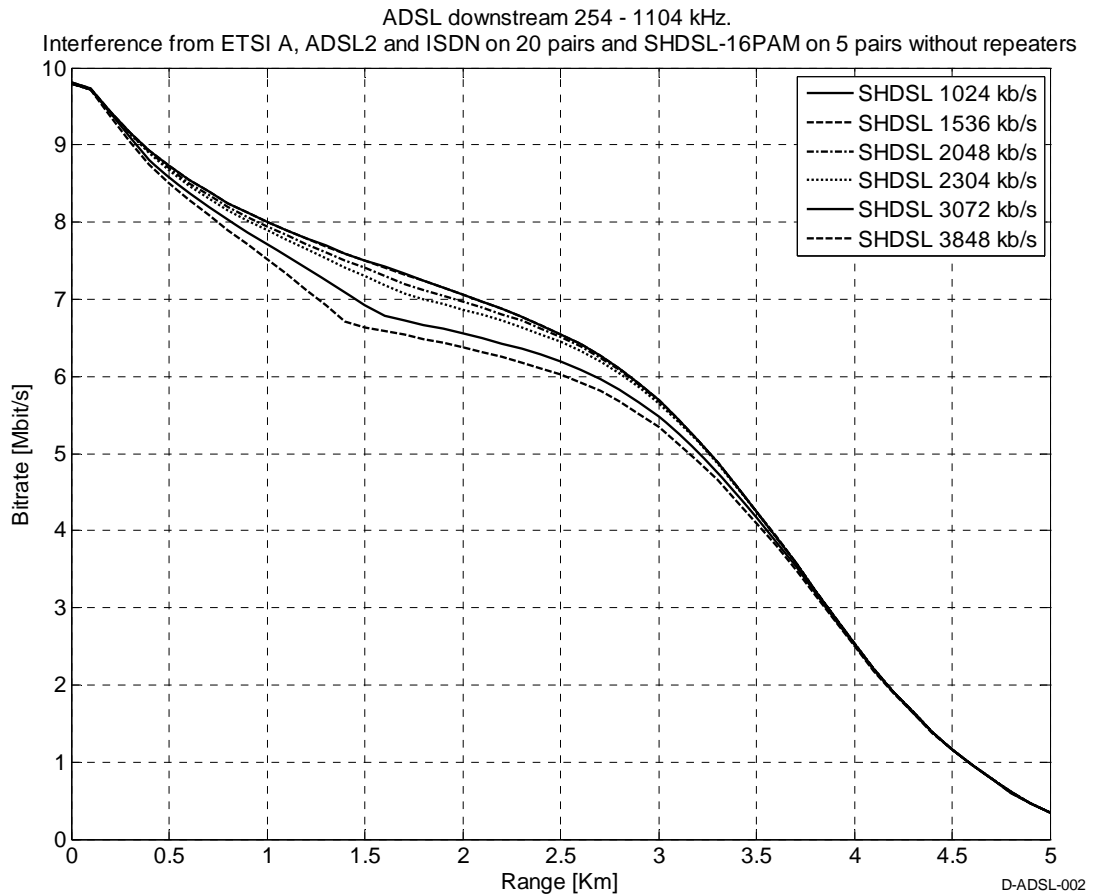
**6.2.2.1 Downstream ADSL with interference from SHDSL on five pairs, varying bitrate**

ADSL2 downstream. 254 – 1104 kHz  
Interference from SHDSL 16 TCPAM  
without repeaters on 5 pairs

SHDSL 16 PAM on 5 pairs						
Bit rate [kbit/s]	1024	1536	2048	2304	3072	3848
$L_{max}$ [km]	2.37	1.85	1.75	1.72	1.58	1.41

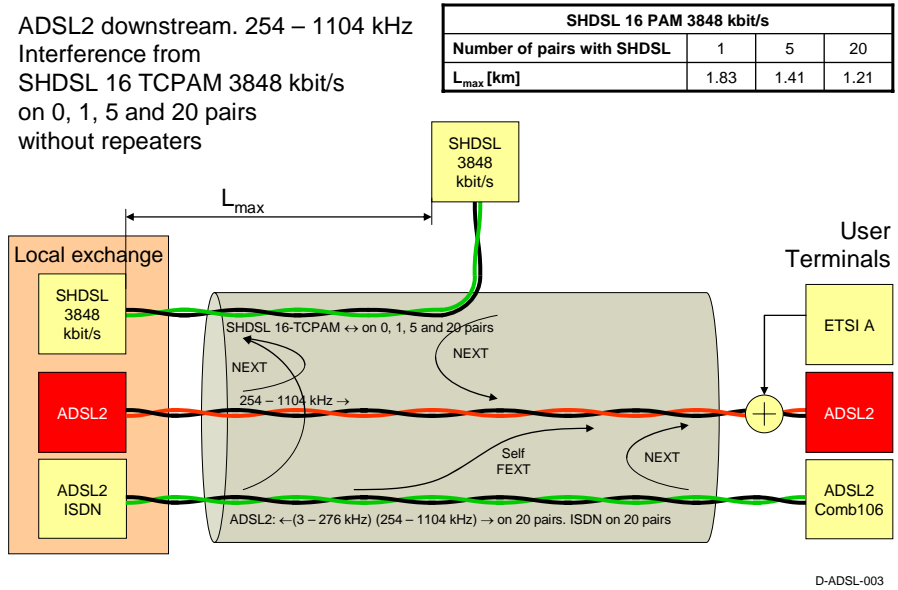


**Figure 6.8 Downstream ADSL. SHDSL 16-PAM interference, varying bitrate.**

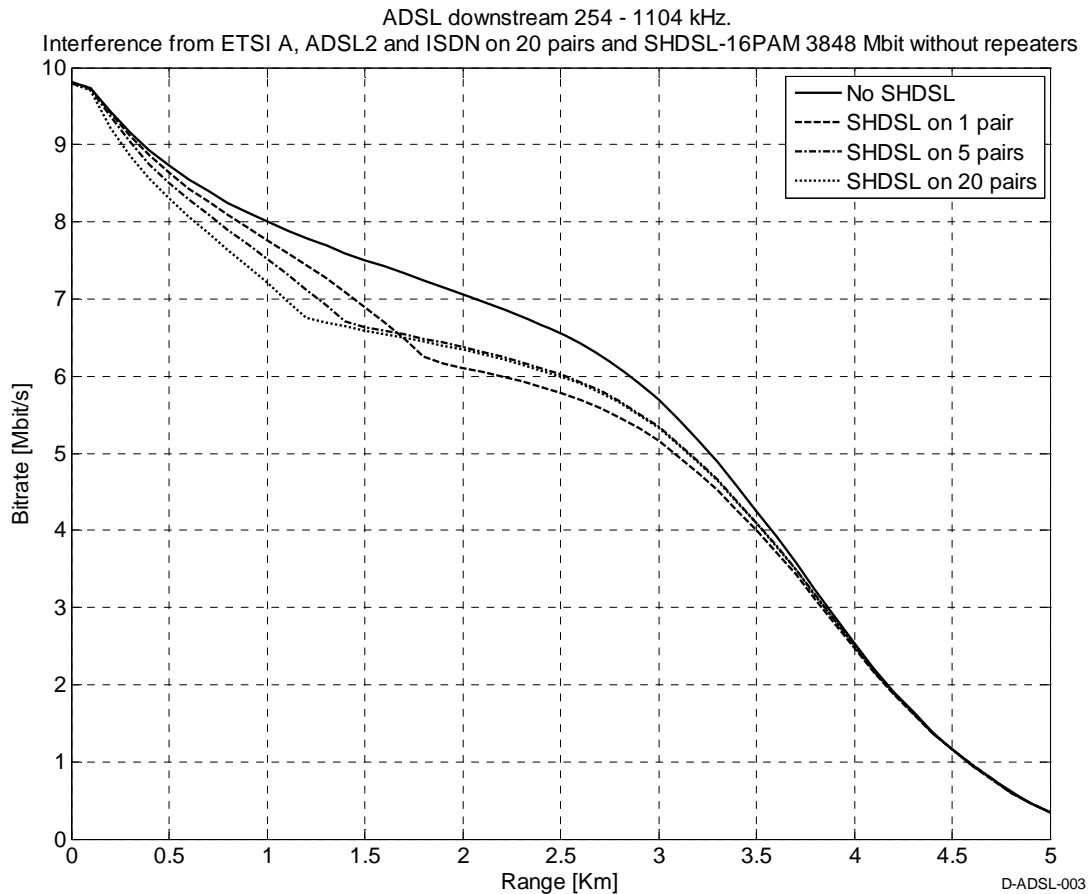


**Figure 6.9 Downstream ADSL. SHDSL 16-PAM interference, varying bitrate.**

**6.2.2.2 Downstream ADSL with interference from SHDSL 16-PAM 3848 Mbit/s, varying number of disturbers**



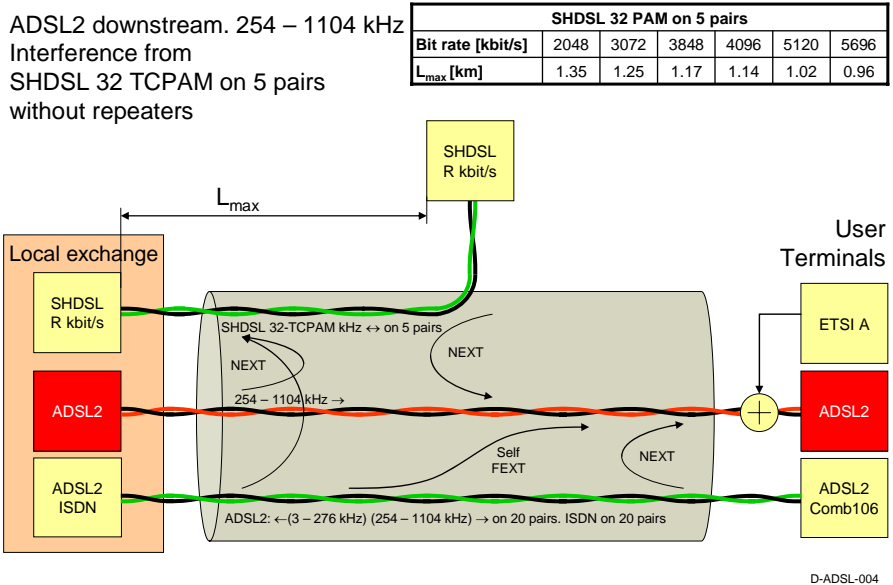
**Figure 6.10 Downstream ADSL. SHDSL 16-PAM interference, varying number of disturbers.**



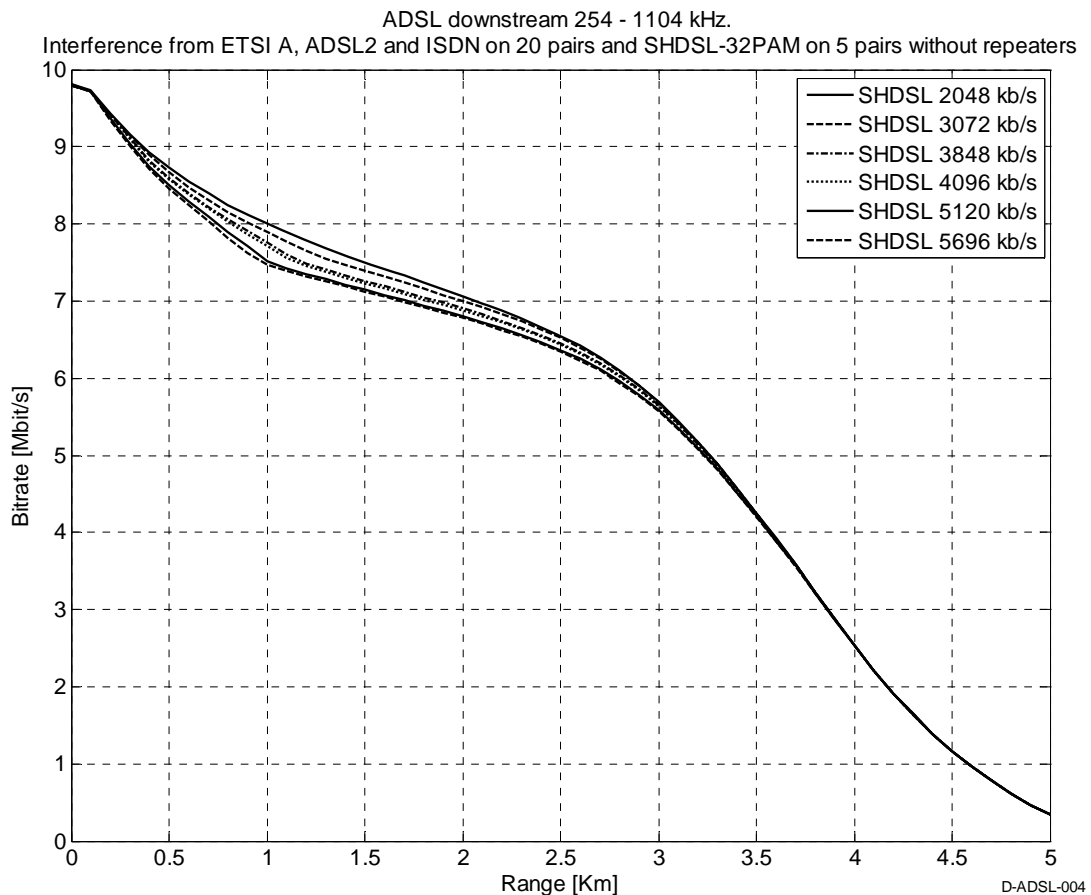
**Figure 6.11 Downstream ADSL. SHDSL 16-PAM interference, varying number of disturbers.**

**6.2.3 Downstream ADSL with interference from SHDSL 32-PAM**

**6.2.3.1 Downstream ADSL with interference from SHDSL 32-PAM on 5 pairs, varying bitrate**



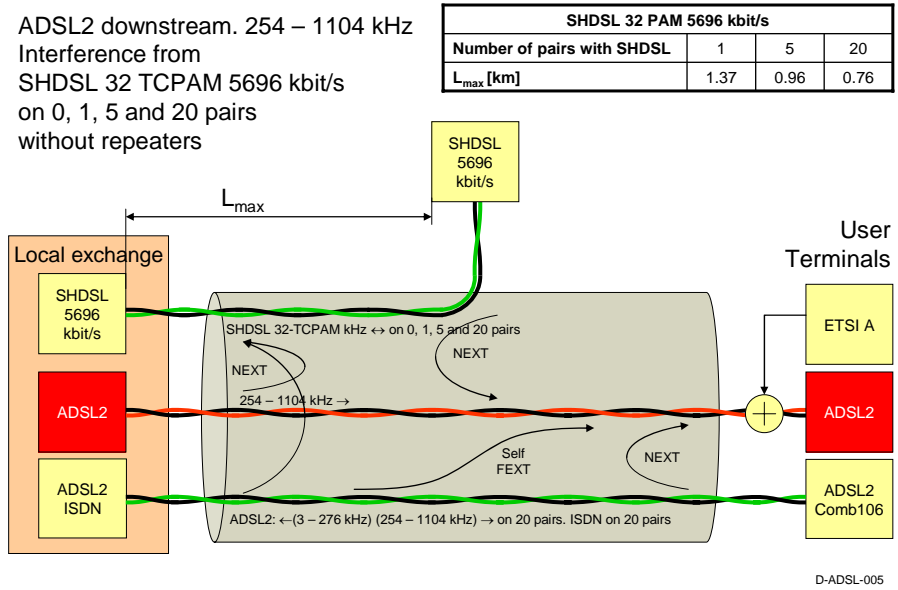
**Figure 6.12 Downstream ADSL. SHDSL 32-PAM interference, varying bitrate.**



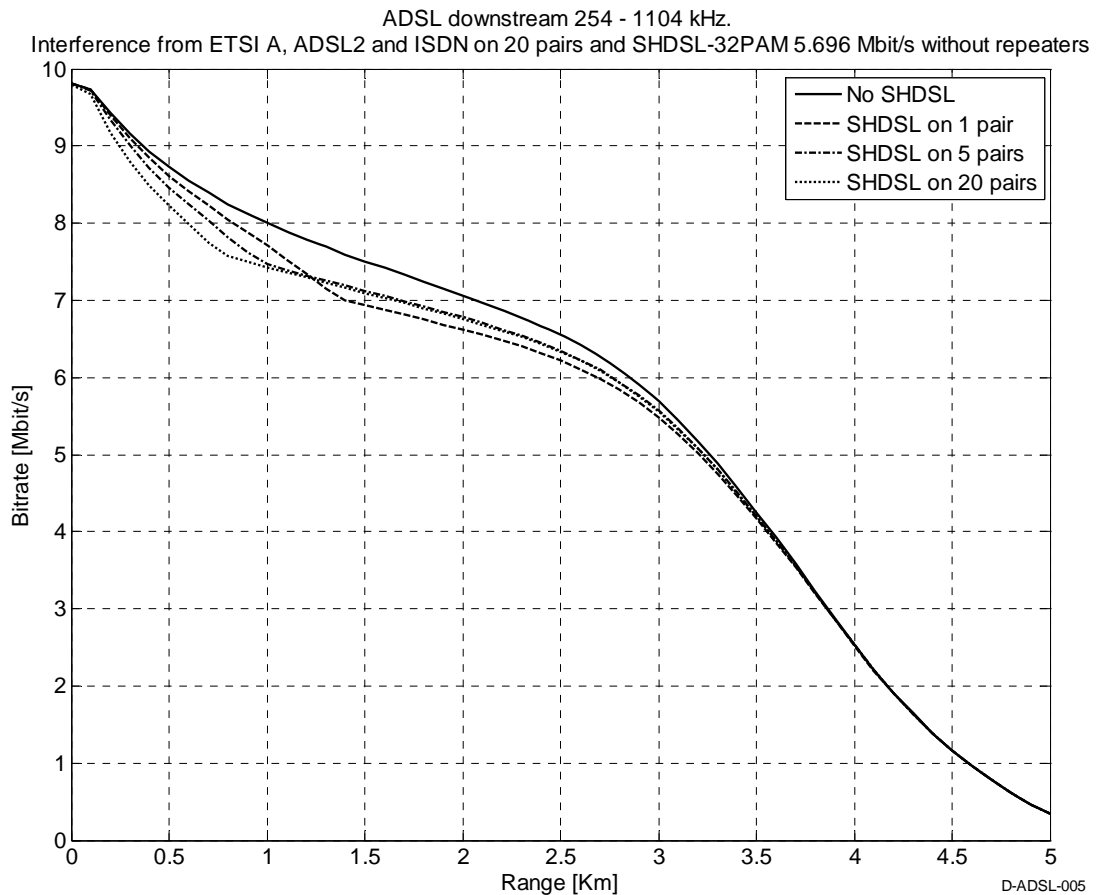
**Figure 6.13 Downstream ADSL. SHDSL 32-PAM interference, varying bitrate.**



**6.2.3.2 Downstream ADSL with interference from SHDSL 32-PAM 5.696 Mbit/s, varying number of disturbers**



**Figure 6.14 Downstream ADSL. SHDSL 32-PAM interference, varying number of disturbers.**

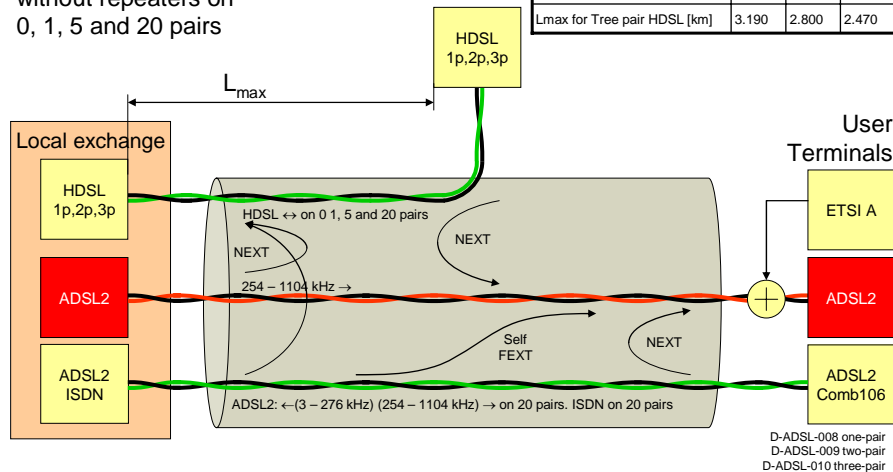


**Figure 6.15 Downstream ADSL. SHDSL 32-PAM interference, varying number of disturbers.**

### 6.2.4 Downstream ADSL with interference from HDSL without repeaters

ADSL2 downstream. 254 – 1104 kHz.  
 Interference from  
 One-, Two- and Three-pair HDSL  
 without repeaters on  
 0, 1, 5 and 20 pairs

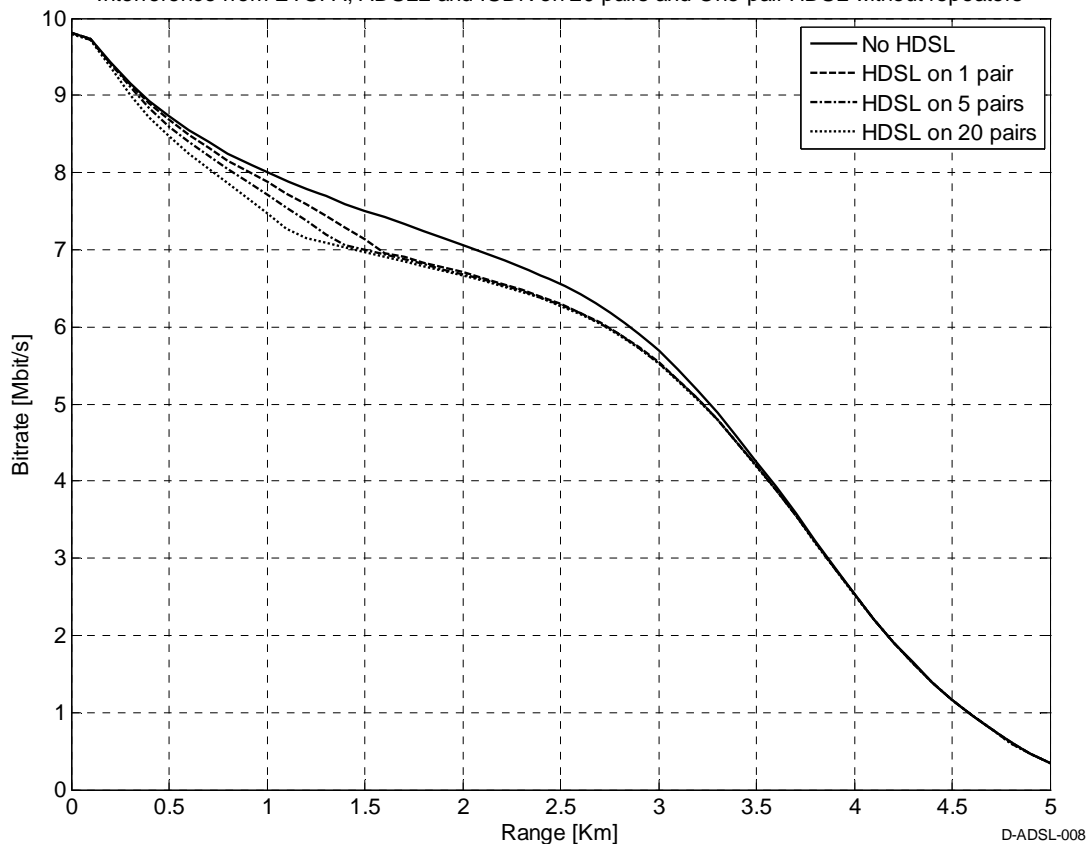
	Number of pairs with HDSL systems		
	1p	5p	20p
L <sub>max</sub> for One-pair HDSL [km]	1.600	1.360	1.150
L <sub>max</sub> for Two pair HDSL [km]	2.560	2.230	1.940
L <sub>max</sub> for Tree pair HDSL [km]	3.190	2.800	2.470



**Figure 6.16 Downstream ADSL. Interference from HDSL without repeaters.**

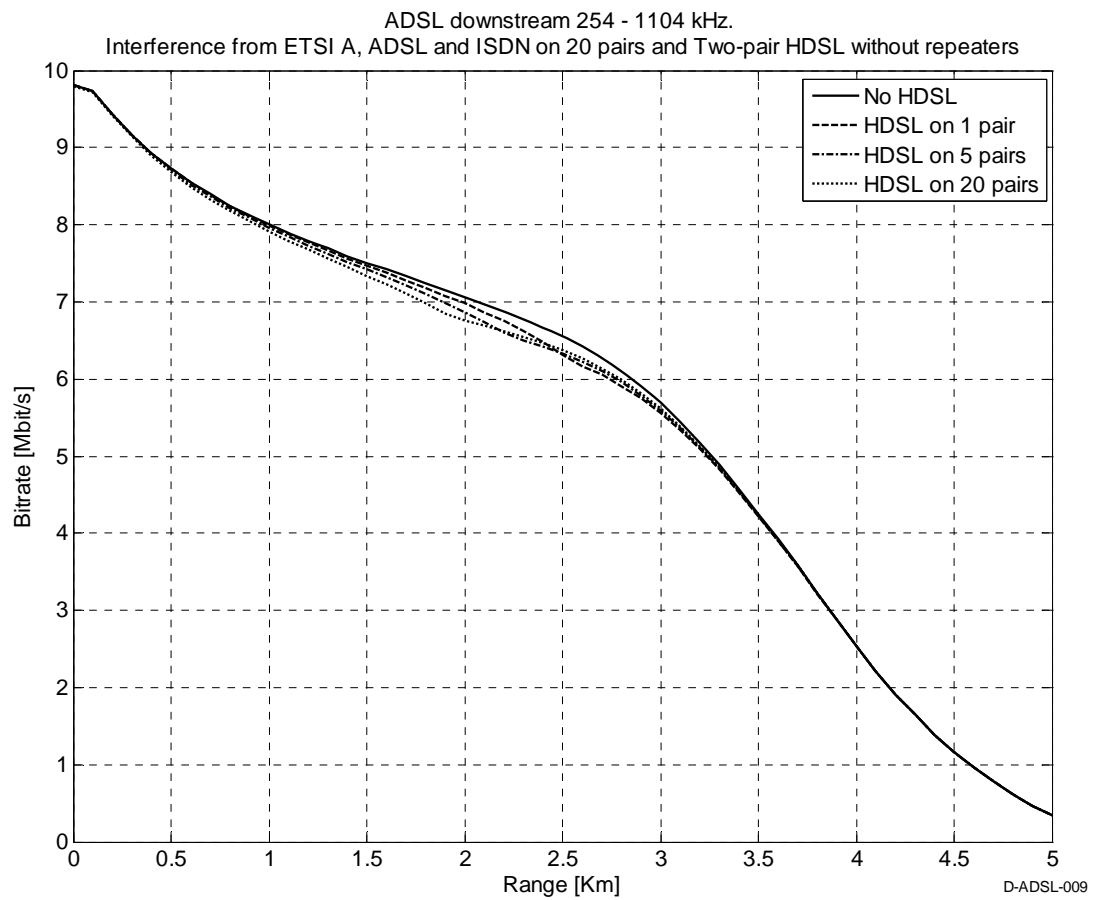
#### 6.2.4.1 Downstream ADSL with interference from One-pair HDSL

ADSL downstream 254 - 1104 kHz.  
 Interference from ETSI A, ADSL2 and ISDN on 20 pairs and One-pair HDSL without repeaters



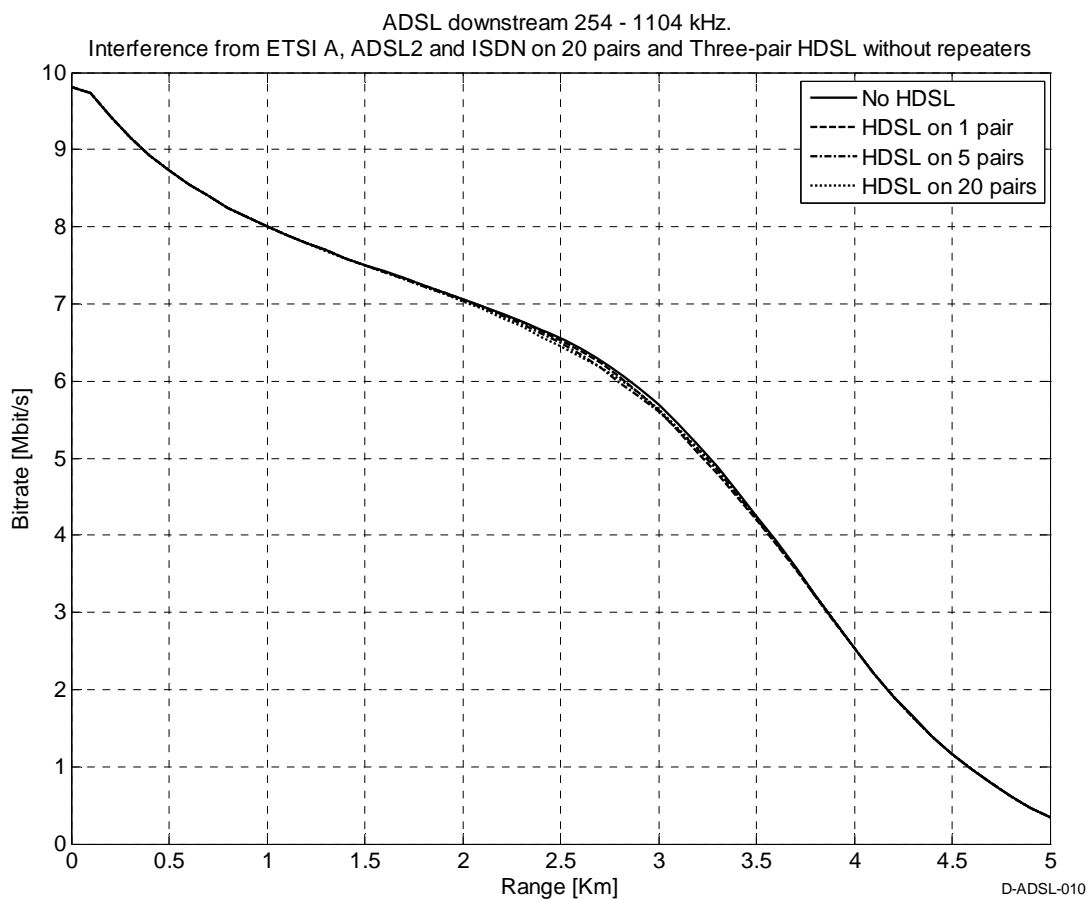
**Figure 6.17 Downstream ADSL. Interference from One-pair HDSL without repeaters, varying number of disturbers.**

### 6.2.4.2 Downstream ADSL with interference from Two-pair HDSL



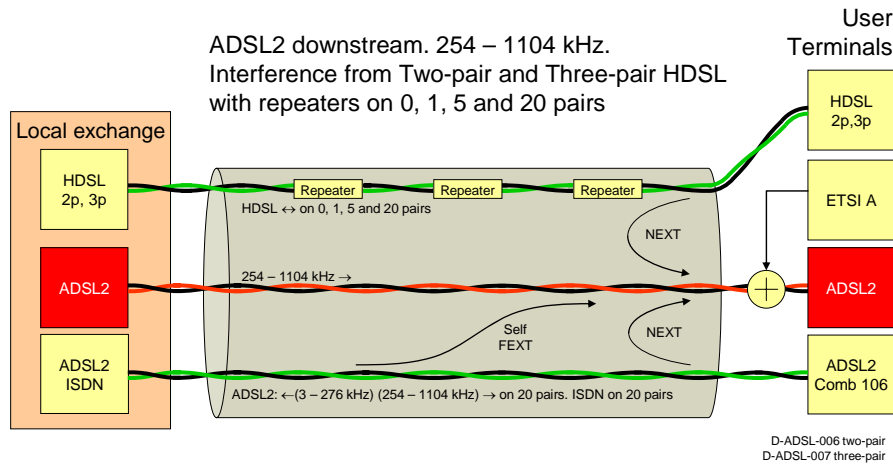
**Figure 6.18 Downstream ADSL. Interference from Two-pair HDSL without repeaters, varying number of disturbers.**

**6.2.4.3 Downstream ADSL with interference from Three-pair HDSL**



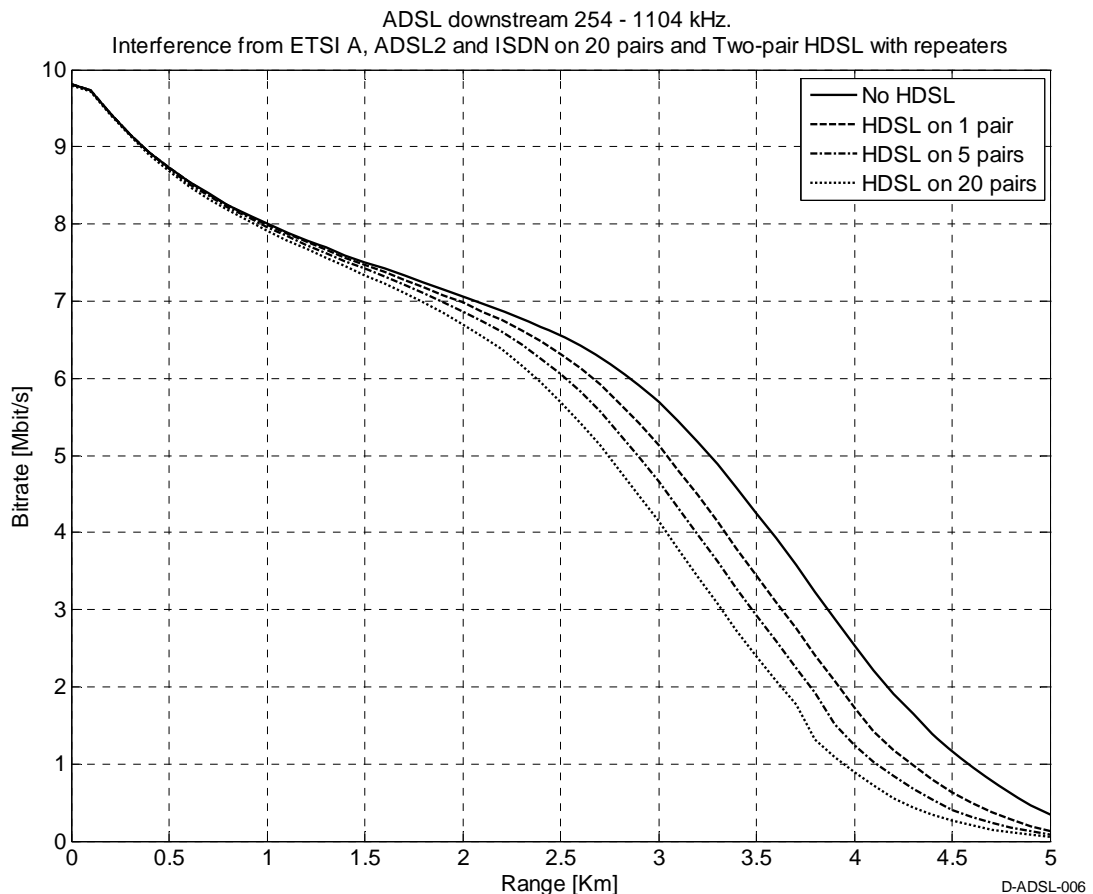
**Figure 6.19 Downstream ADSL. Interference from Three-pair HDSL without repeaters, varying number of disturbers.**

**6.2.5 Downstream ADSL with interference from HDSL with repeaters**



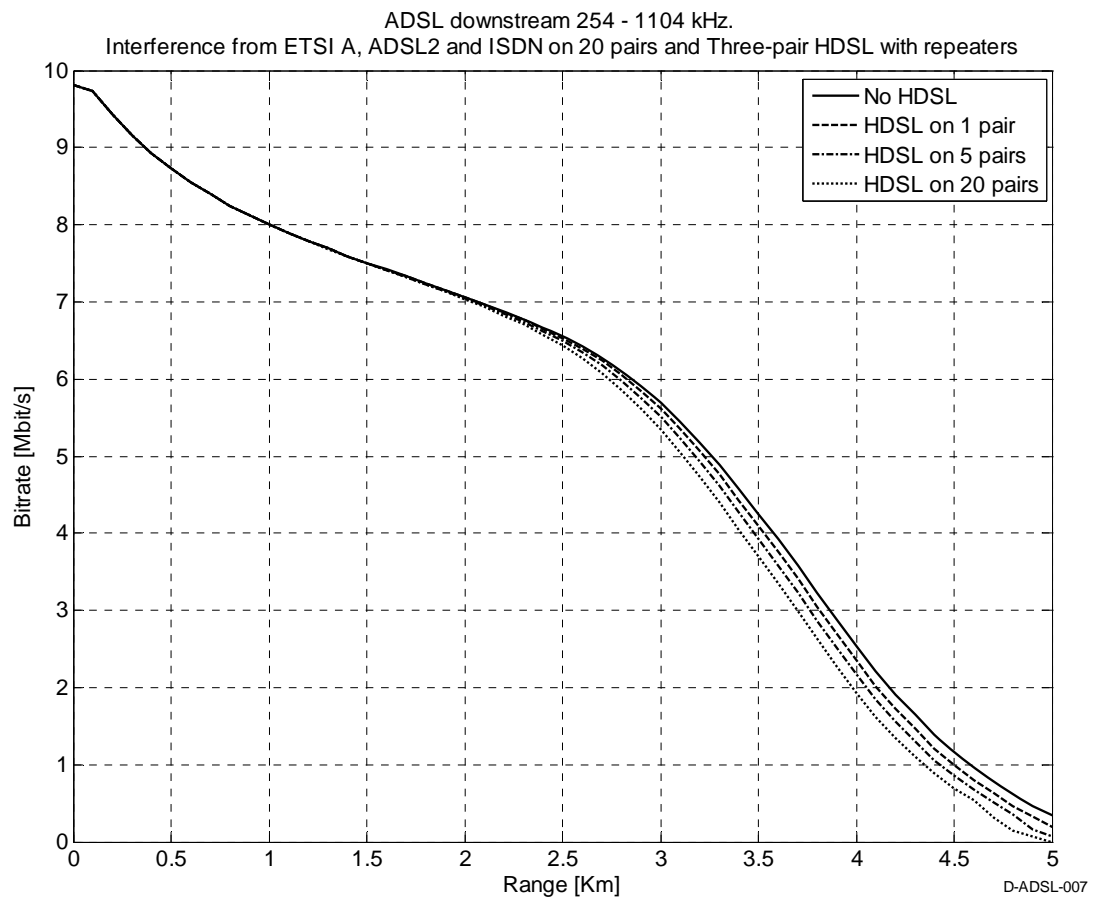
**Figure 6.20 Downstream ADSL. Interference from HDSL with repeaters, varying number of disturbers.**

**6.2.5.1 Downstream ADSL with interference from Two-pair HDSL with repeaters**



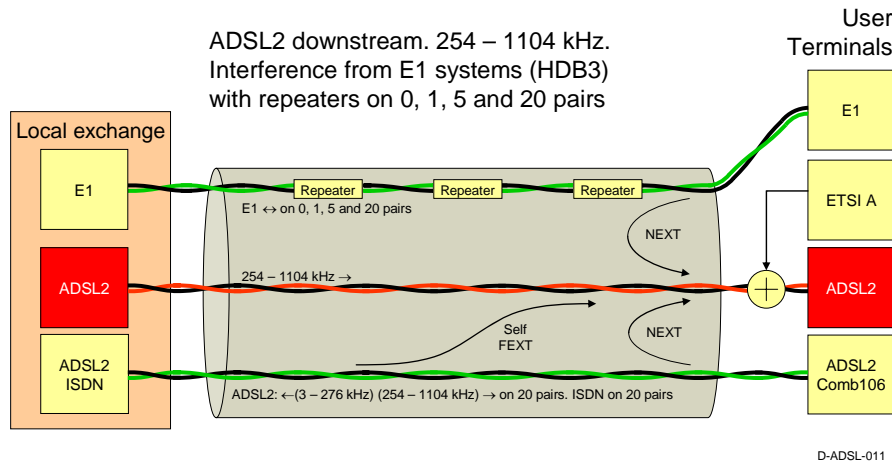
**Figure 6.21 Downstream ADSL. Interference from Two-pair HDSL with repeaters, varying number of disturbers.**

### 6.2.5.2 Downstream ADSL with interference from Tree-pair HDSL with repeaters

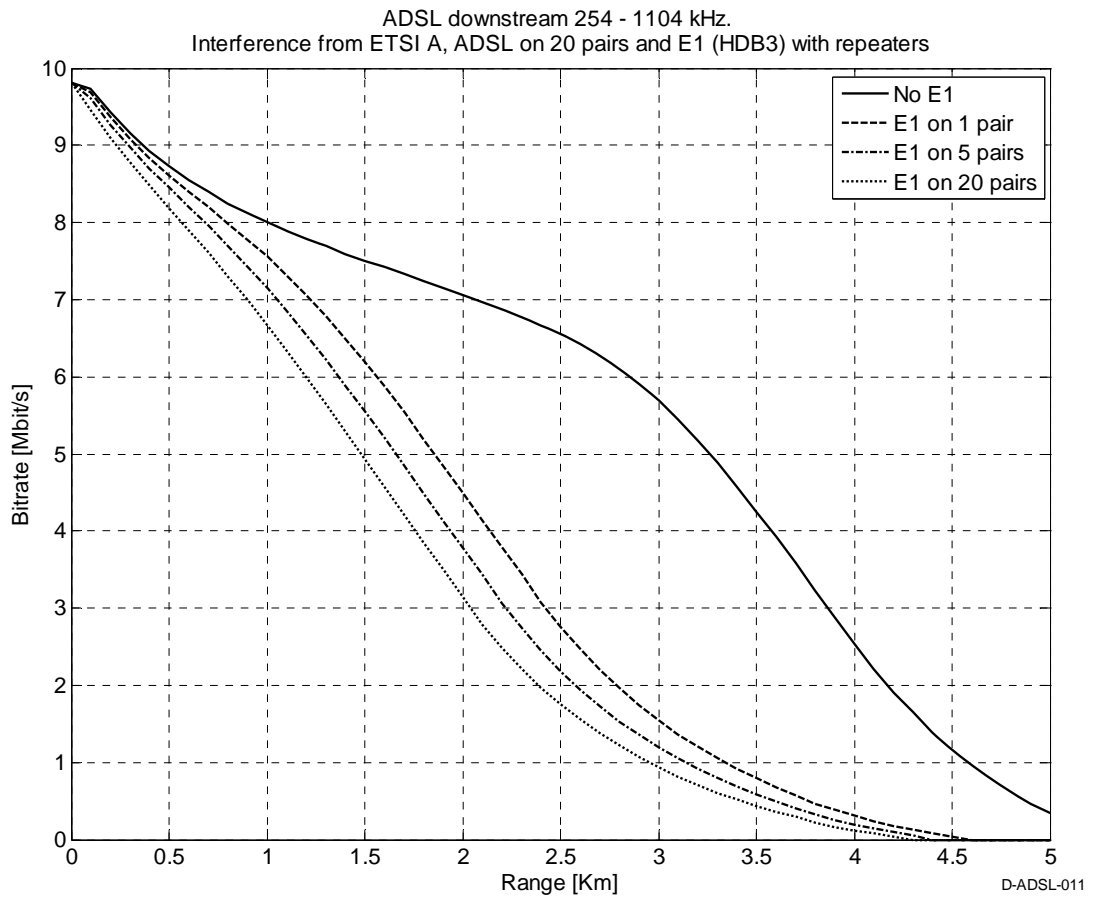


**Figure 6.22 Downstream ADSL. Interference from Three-pair HDSL with repeaters, varying number of disturbers.**

**6.2.6 Downstream ADSL with interference from E1-systems with repeaters**



**Figure 6.23 Downstream ADSL. Interference from E1-systems with repeaters.**



**Figure 6.24 Downstream ADSL. Interference from E1-systems with repeaters.**

### 6.3 Downstream ADSL2+ (254 – 2208 kHz) with all DSLAMs in the local exchange

This section shows the performance of downstream ADSL2+ for the same interference situations that were presented for ADSL in Section 6.2. The bitrates of ADSL2+ are higher than for ADSL due to the extended bandwidth. Hence, the relative degradations are smaller for ADSL2+, but there are no other important differences between ADSL and ADSL2+. The reader is referred to the main comments for downstream ADSL given in Section 6.2 and the detailed results for ADSL2+ given below.

Just as for ADSL, the additional degradation that will be caused by introducing SHDSL Annex G is a critical issue also for downstream ADSL2+. The results for ADSL2+ are summarized in Table 6.2 and Figure 6.25. The reference system is an ADSL2+ system without crosstalk from HDSL or SHDSL. The background noise is ETSI noise A plus crosstalk from 20 ADSL2+ systems and 20 ISDN systems. The table shows the degradation in percent for downstream ADSL2+ caused by additional crosstalk from each of the following systems:

- One-pair HDSL
- Current SHDSL, 2.3 Mbit/s, 16-PAM
- SHDSL, 3.85 Mbit/s, 16-PAM, Annex G
- SHDSL, 5.7 Mbit/s, 32-PAM, Annex G

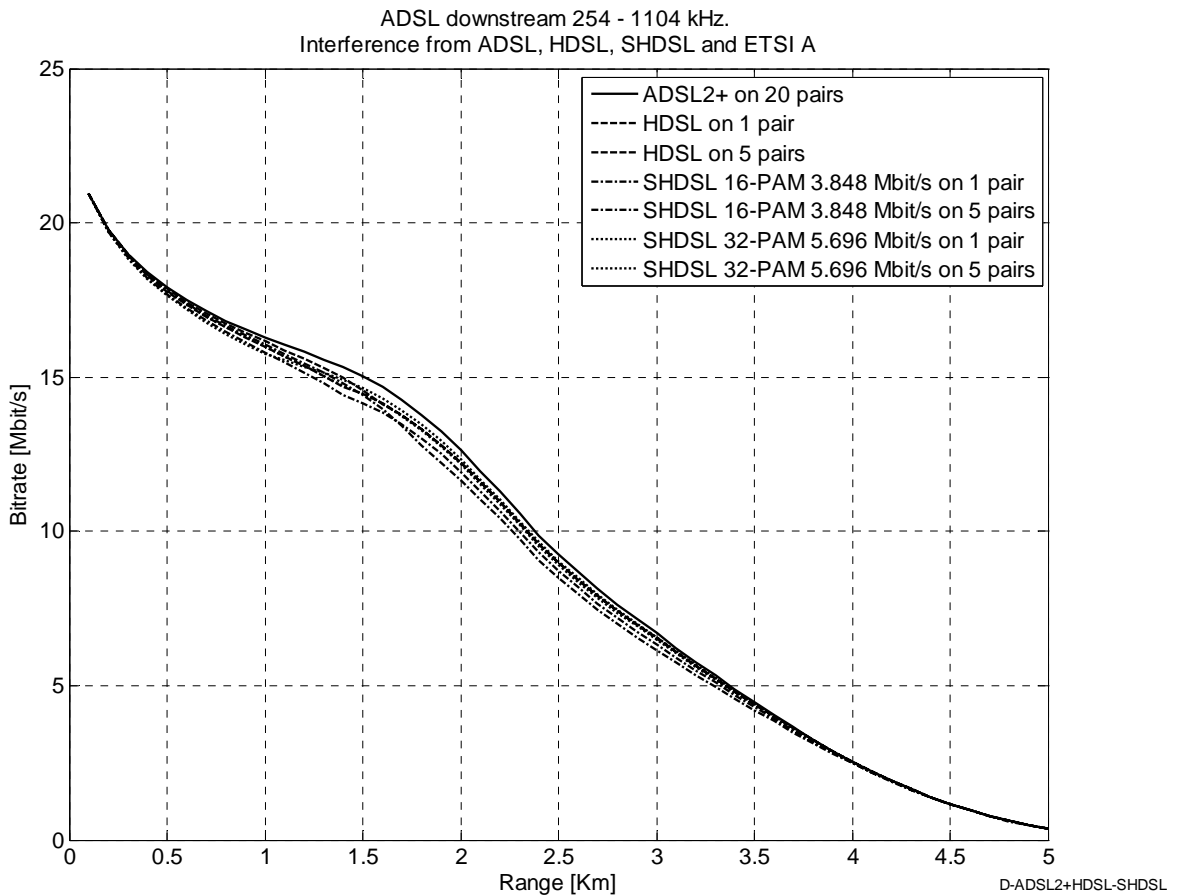
For all cases the results show the worst degradation caused by 1 to 5 disturbing HDSL or SHDSL systems.

**Table 6.2 Degradation of downstream ADSL2+ bitrate due to different versions of SHDSL and HDSL.**

Reach of ADSL2+ system:	1 km	1.5 km	2 km	2.5 km	3 km
ADSL2+ bitrate without HDSL and SHDSL (reference)	16.4 Mbit/s	15.1 Mbit/s	12.7 Mbit/s	9.4 Mbit/s	6.8 Mbit/s
Reduction in ADSL2+ bitrate due to One-pair HDSL	2%	4%	4%	3%	3%
Reduction in ADSL2+ bitrate due to 2.3 Mbit/s SHDSL 16-PAM	1%	2%	1%	1%	1%
Reduction in ADSL2+ bitrate due to 3.85 Mbit/s SHDSL 16-PAM	3%	6%	7%	8%	10%
Reduction in ADSL2+ bitrate due to 5.7 Mbit/s SHDSL 32-PAM	3%	4%	4%	4%	3%
Reduction for 3.85 Mbit/s SHDSL 16-PAM compared to One-pair HDSL	1%	2%	3%	5%	7%
Reduction for 5.7 Mbit/s SHDSL 32-PAM compared to One-pair HDSL	1%	0%	0%	-1%	-4%

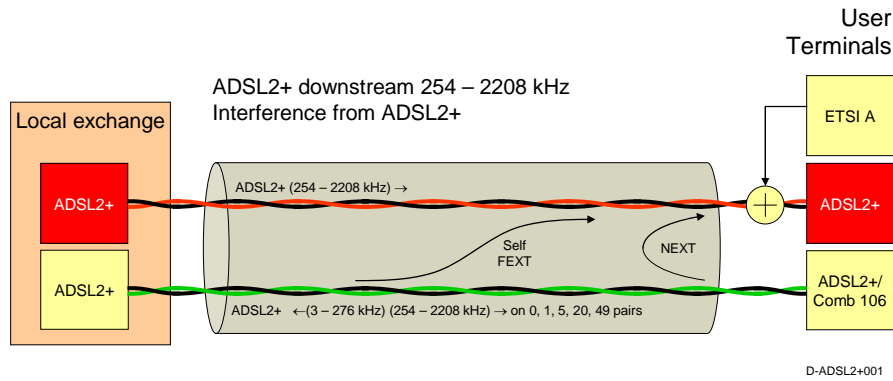


Also for ADSL2+, the current HDSL or SHDSL system that causes the largest degradations is One-pair HDSL. Hence the results for the systems introduced in SHDSL Annex G are compared to One-pair HDSL. The results show that the 5.7 Mbit/s SHDSL 32-PAM system causes close to the same degradation as HDSL. The worst degradation is caused by 3.85 Mbit/s SHDSL with 16-PAM modulation. The reason for this is that the 3.85 Mbit/s system has a significantly longer reach than the 5.7 Mbit/s system, so that it generates a more severe NEXT. The most interesting use of ADSL2+ is for reach around 2 km and below. In this region the degradation of downstream ADSL2+ is significantly smaller than for downstream ADSL and in the order of 3% and less. This means that SHDSL Annex G systems will not cause significantly worse degradation of downstream ADSL2+ than One-pair HDSL systems.

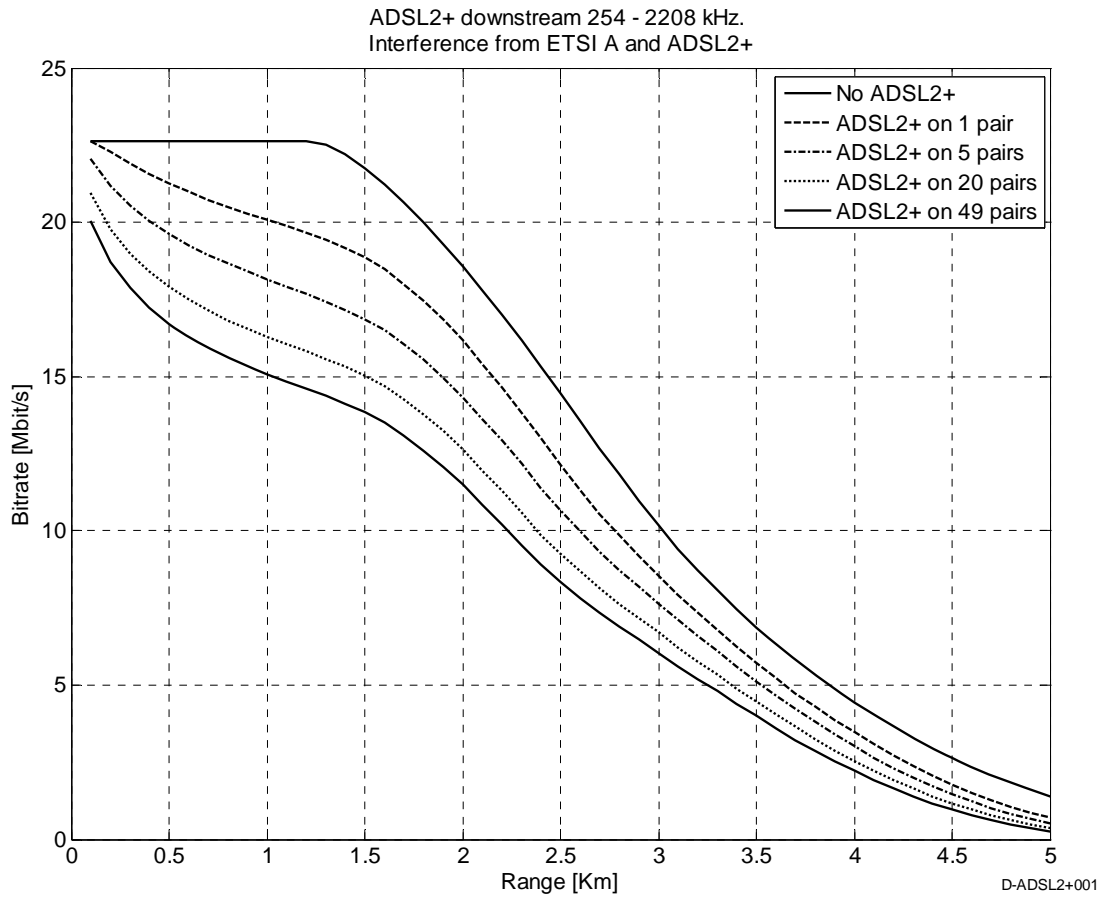


**Figure 6.25 Downstream ADSL2+. Interference from ADSL2+, One-pair HDSL, SHDSL 16-PAM 3.848 Mbit/s and SHDSL 32-PAM 5.696 Mbit/s.**

**6.3.1 Downstream ADSL2+ with interference from ADSL2+**

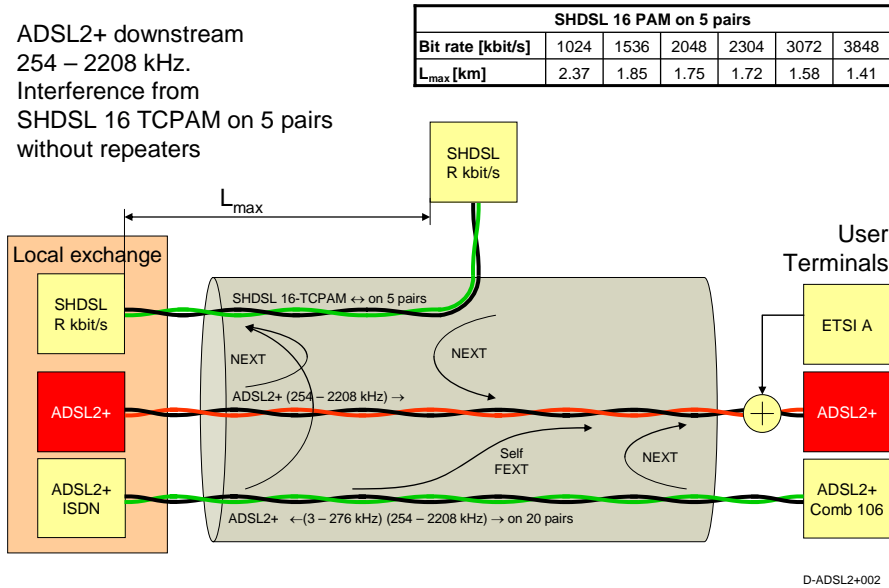


**Figure 6.26 Downstream ADSL2+. Interference from ADSL2+, varying number of disturbers.**

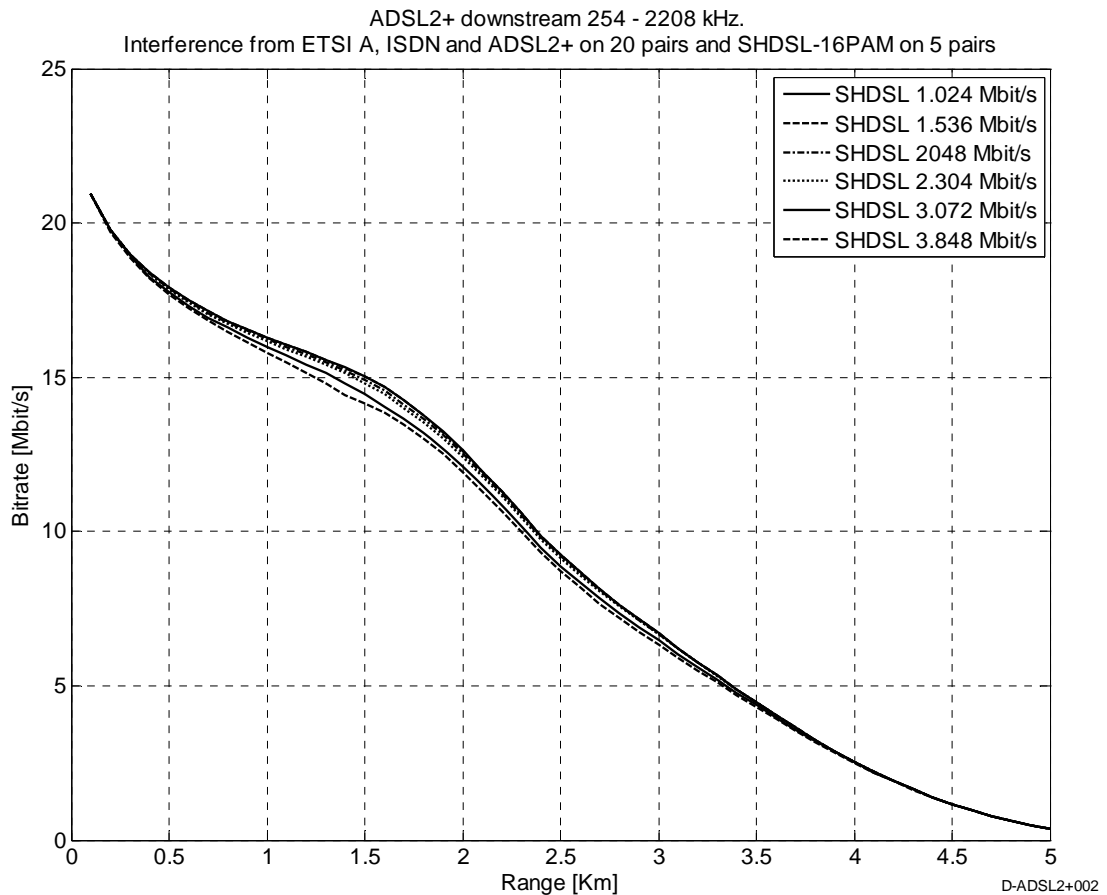


**Figure 6.27 Downstream ADSL2+. Interference from ADSL2+, varying number of disturbers.**

**6.3.2 Downstream ADSL2+ with interference from SHDSL 16-PAM on 5 pairs without repeaters**

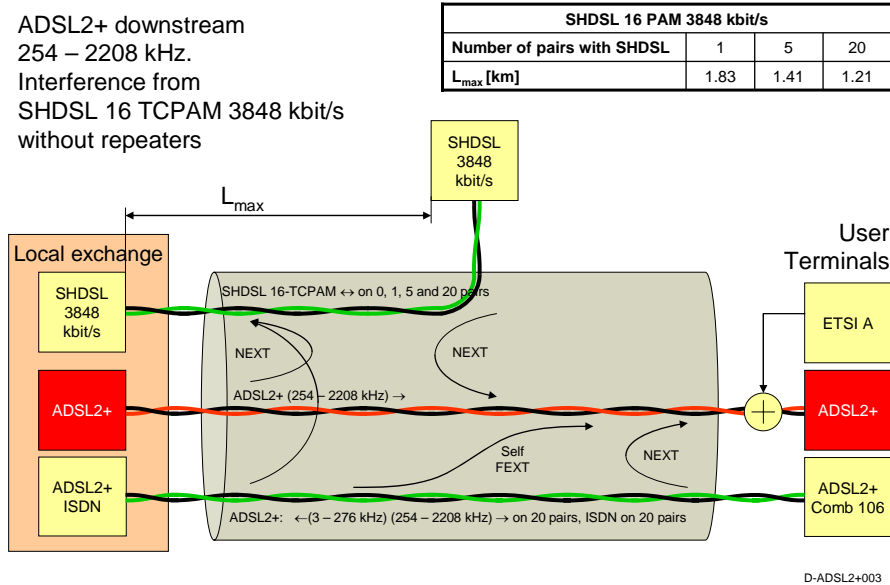


**Figure 6.28 Downstream ADSL2+. Interference from SHDSL 16-PAM without repeaters, varying bitrate.**

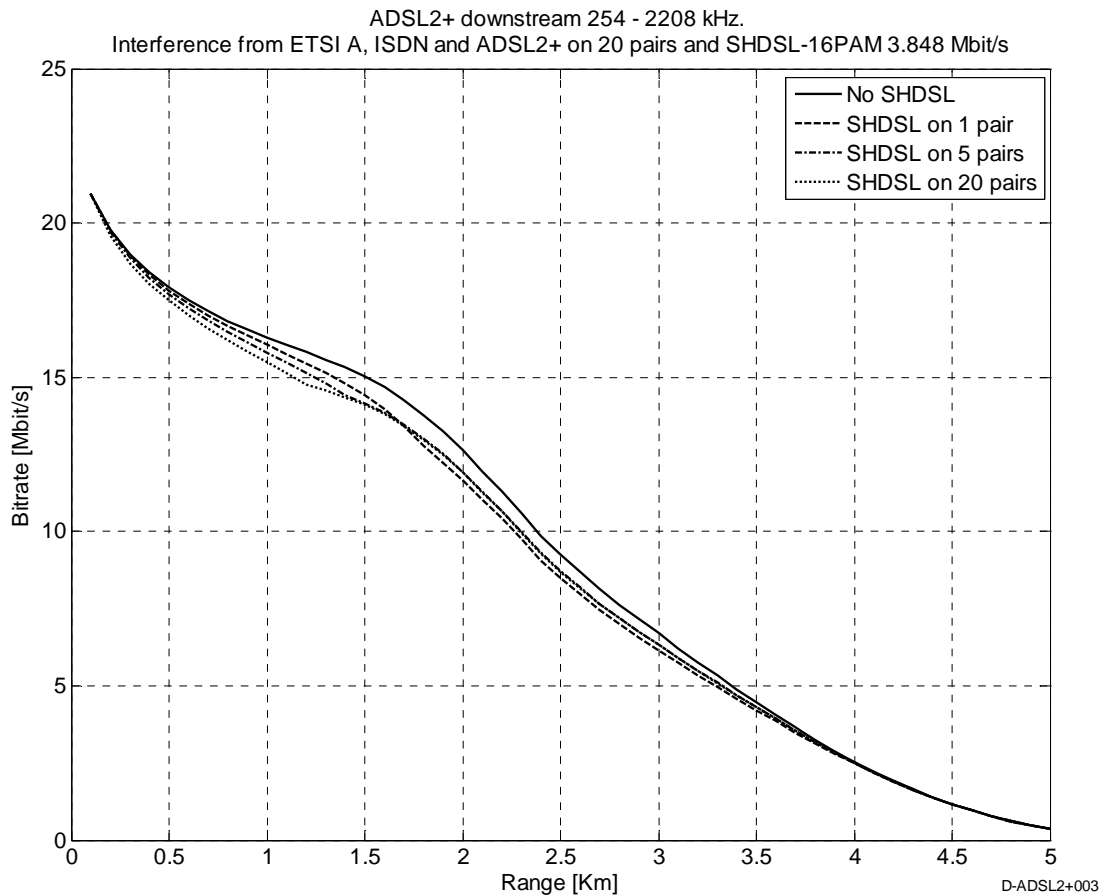


**Figure 6.29 Downstream ADSL2+. Interference from SHDSL 16-PAM without repeaters.**

**6.3.3 Downstream ADSL2+ with interference from SHDSL 16-PAM 3848 kbit/s without repeaters**

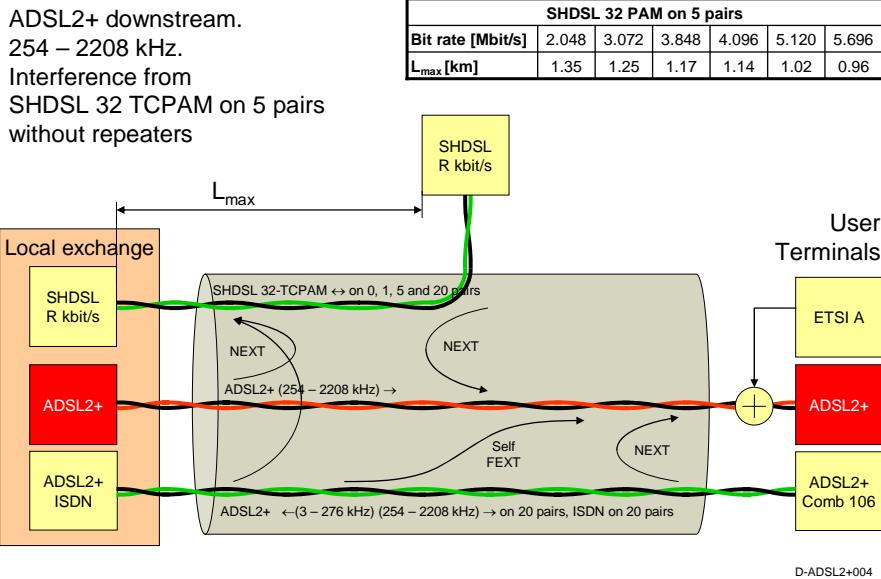


**Figure 6.30 Downstream ADSL2+. Interference from SHDSL 16-PAM without repeaters, varying number of disturbers.**

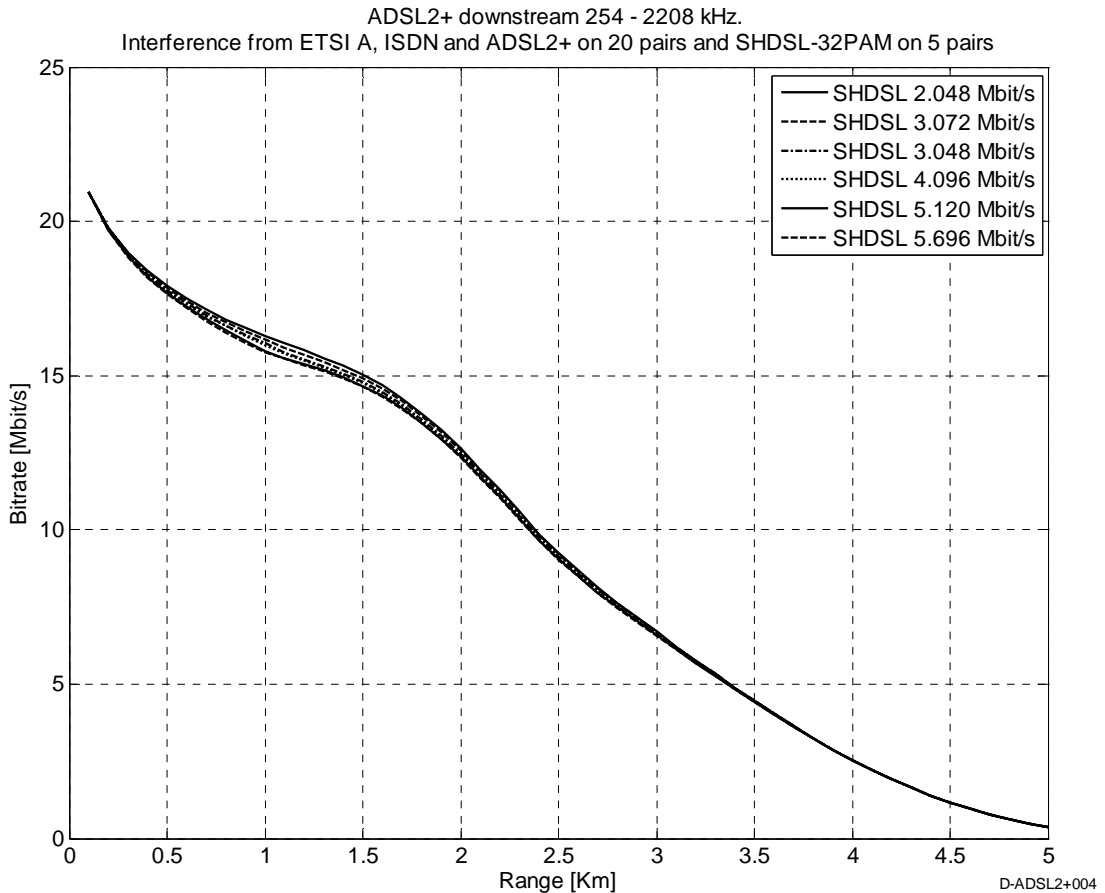


**Figure 6.31 Downstream ADSL2+. Interference from SHDSL 16-PAM without repeaters, varying number of disturbers.**

**6.3.4 Downstream ADSL2+ with interference from SHDSL 32-PAM on 5 pairs without repeaters**

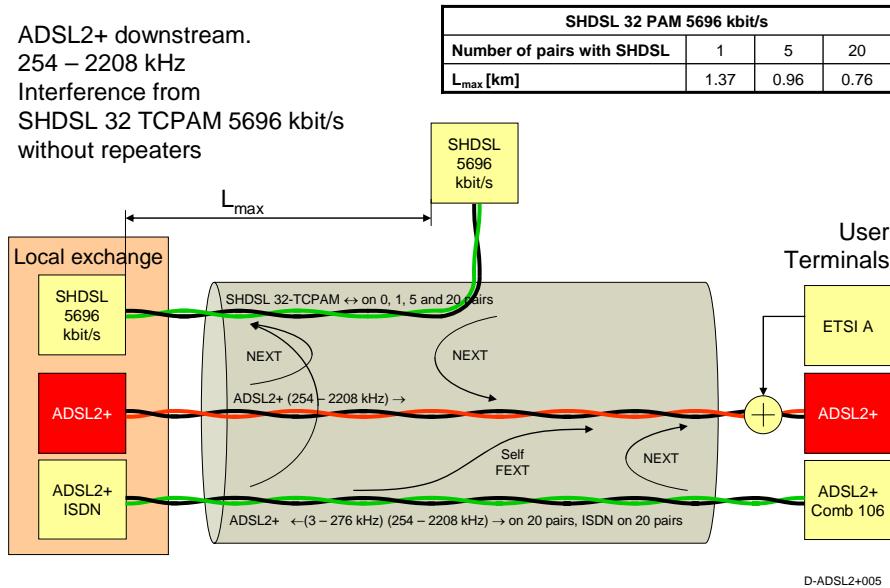


**Figure 6.32 Downstream ADSL2+. Interference from SHDSL 32-PAM without repeaters, varying bitrate.**

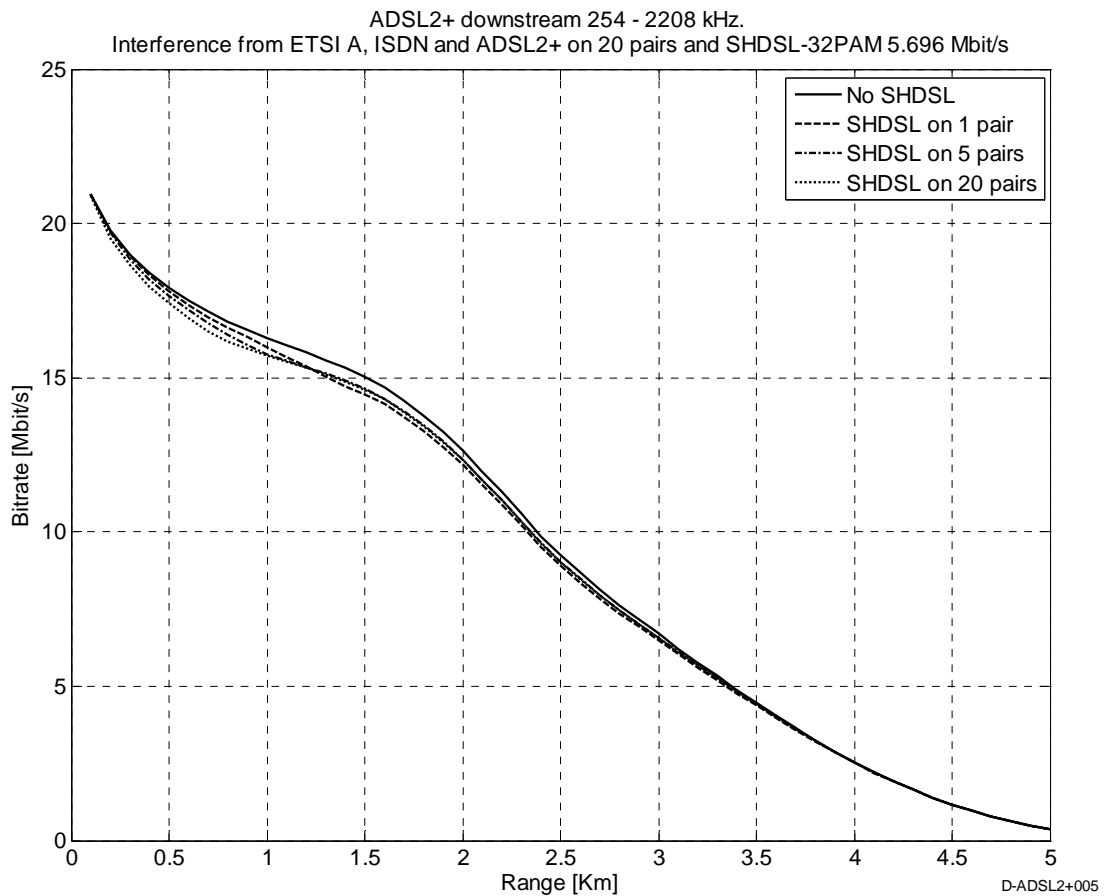


**Figure 6.33 Downstream ADSL2+. Interference from SHDSL 32-PAM without repeaters, varying bitrate.**

**6.3.5 Downstream ADSL2+ with interference from SHDSL 32-PAM 5696 kbit/s without repeaters**



**Figure 6.34 Downstream ADSL2+. Interference from SHDSL 32-PAM without repeaters, varying number of disturbers.**

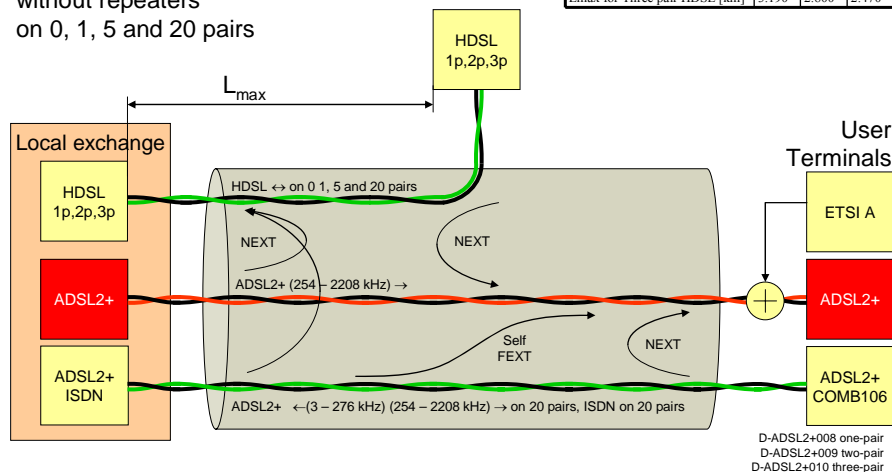


**Figure 6.35 Downstream ADSL2+. Interference from SHDSL 32-PAM without repeaters, varying number of disturbers.**

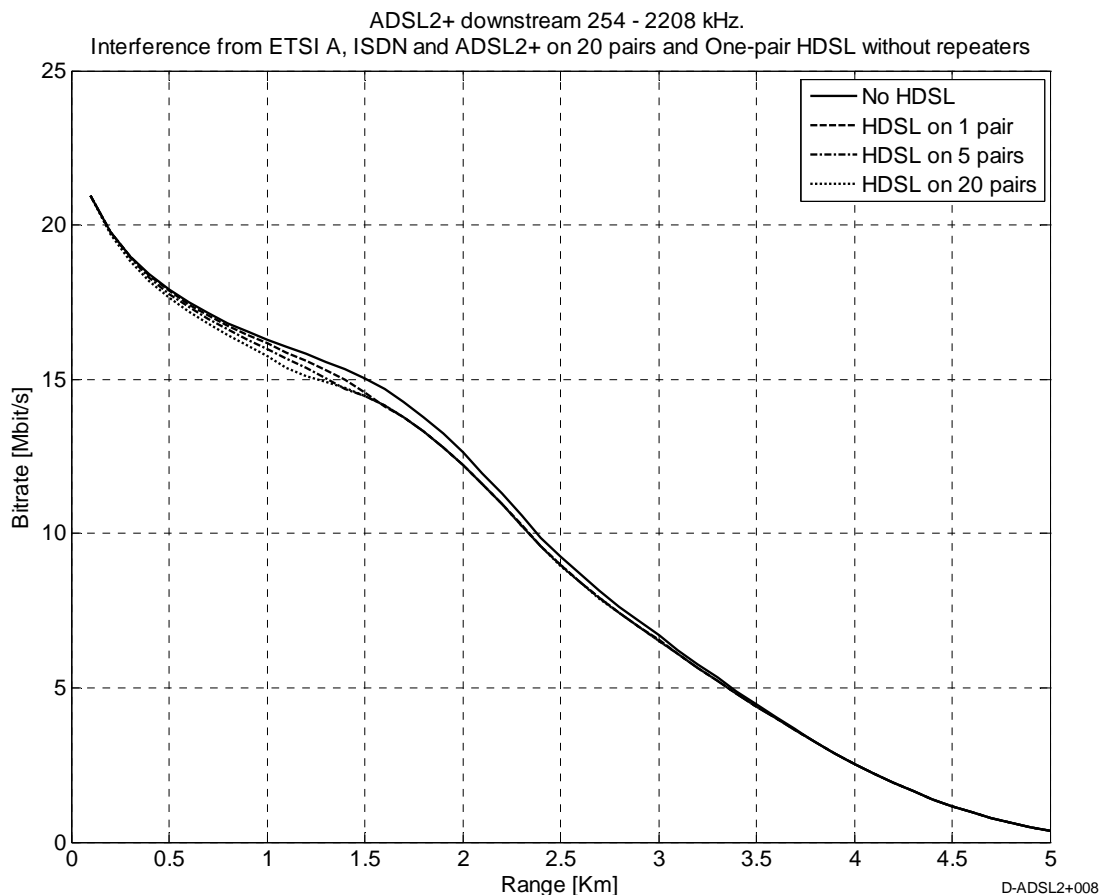
### 6.3.6 Downstream ADSL2+ with interference from One-, Two- and Three-pair HDSL without repeaters on 0, 1, 5 and 20 pairs

ADSL2+ downstream 254 – 2208 kHz  
 Interference from  
 One-, Two- and Three-pair HDSL  
 without repeaters  
 on 0, 1, 5 and 20 pairs

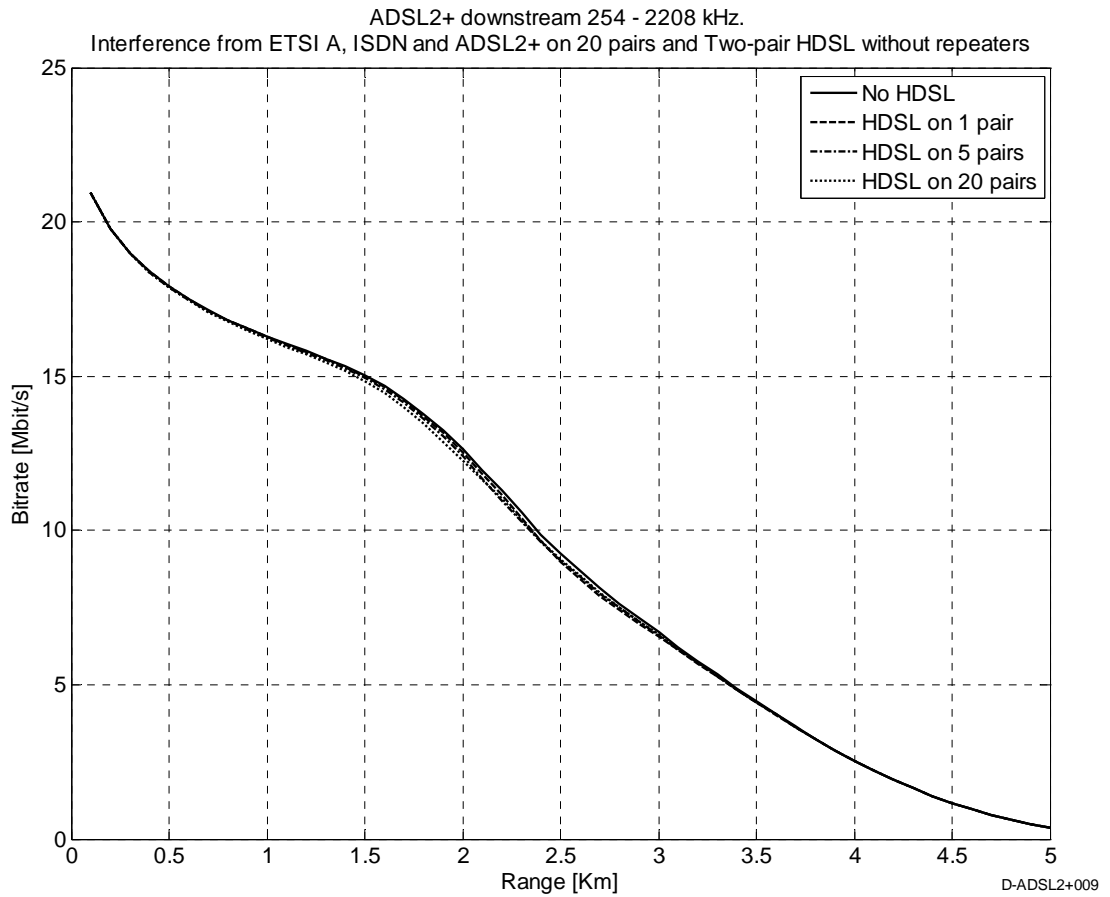
	Number of pairs with HDSL systems		
	1p	5p	20p
Lmax for One-pair HDSL [km]	1.600	1.360	1.150
Lmax for Two pair HDSL [km]	2.560	2.230	1.940
Lmax for Three pair HDSL [km]	3.190	2.800	2.470



**Figure 6.36 Downstream ADSL2+. Interference from HDSL systems without repeaters, varying number of disturbers.**

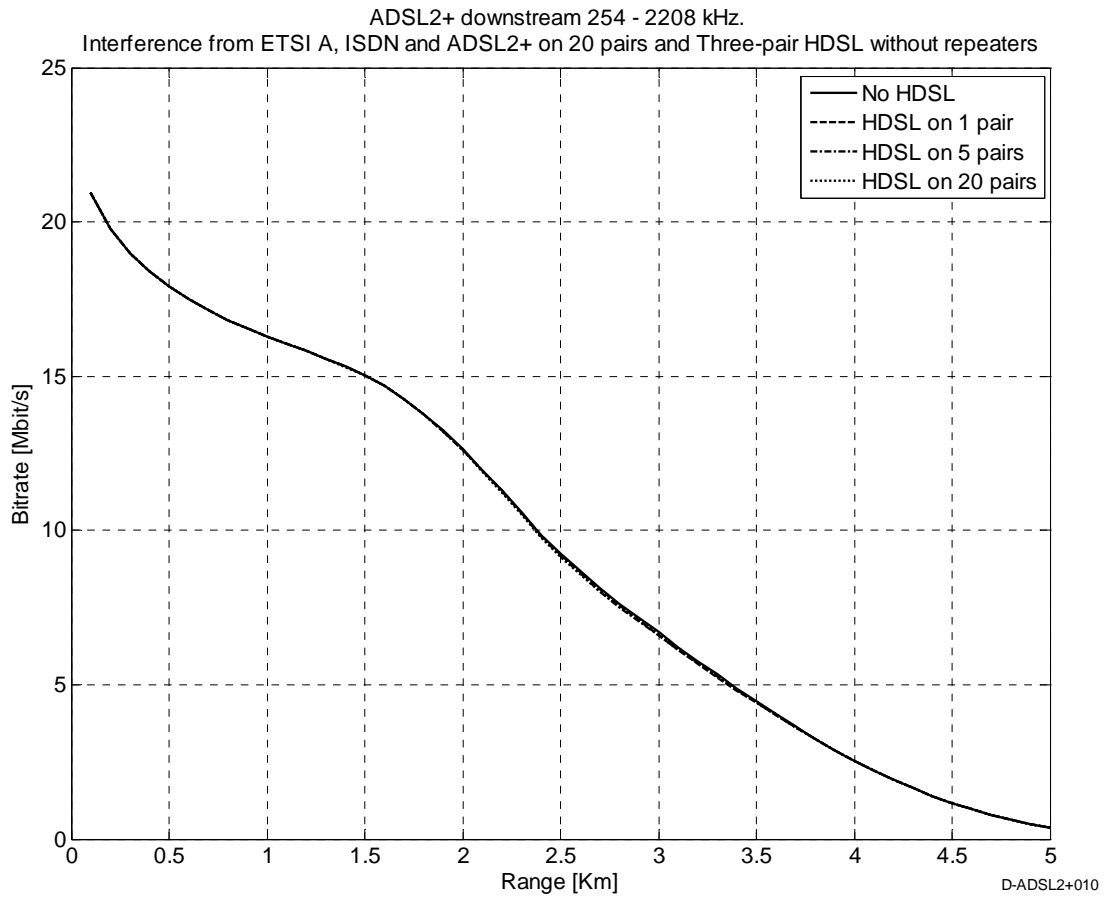


**Figure 6.37 Downstream ADSL2+. Interference from One-pair HDSL without repeaters, varying number of disturbers.**



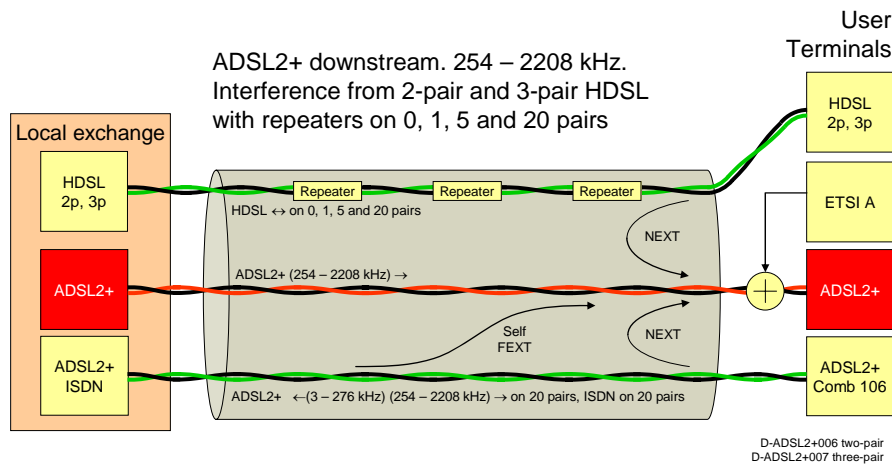
**Figure 6.38 Downstream ADSL2+. Interference from Two-pair HDSL systems without repeaters, varying number of disturbers.**



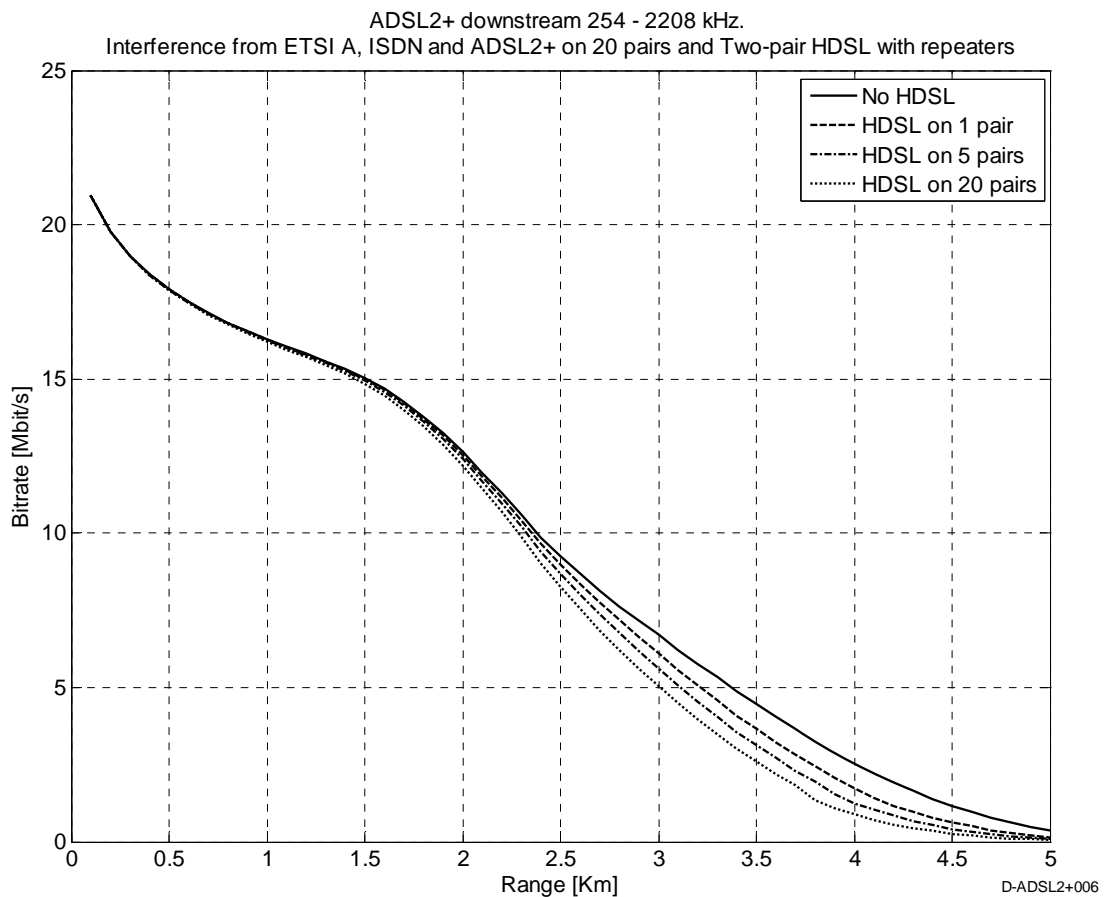


**Figure 6.39 Downstream ADSL2+. Interference from Three-pair HDSL without repeaters, varying number of disturbers.**

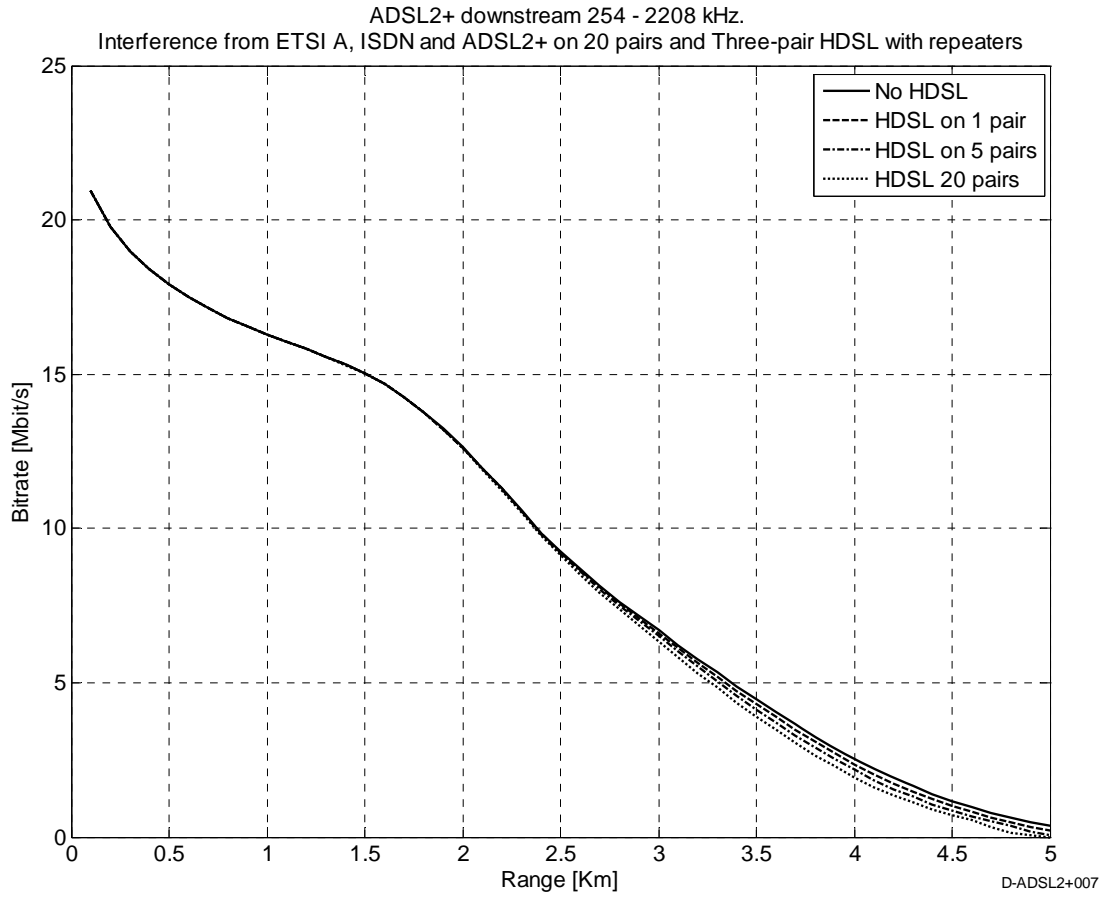
**6.3.7 Downstream ADSL2+ with interference from Two-pair and Three-pair HDSL with repeaters on 0, 1, 5 and 20 pairs**



**Figure 6.40 Downstream ADSL2+. Interference from Two-pair and Three-pair HDSL with repeaters, varying number of disturbers.**

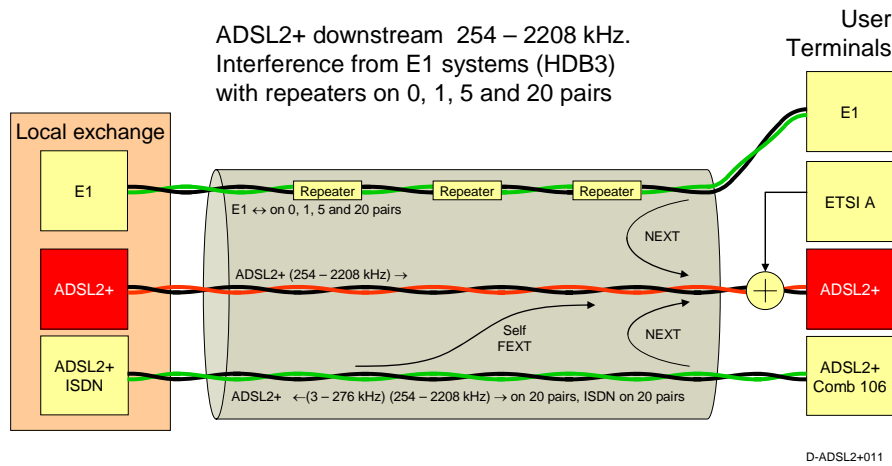


**Figure 6.41 Downstream ADSL2+. Interference from Two-pair HDSL with repeaters, varying number of disturbers.**

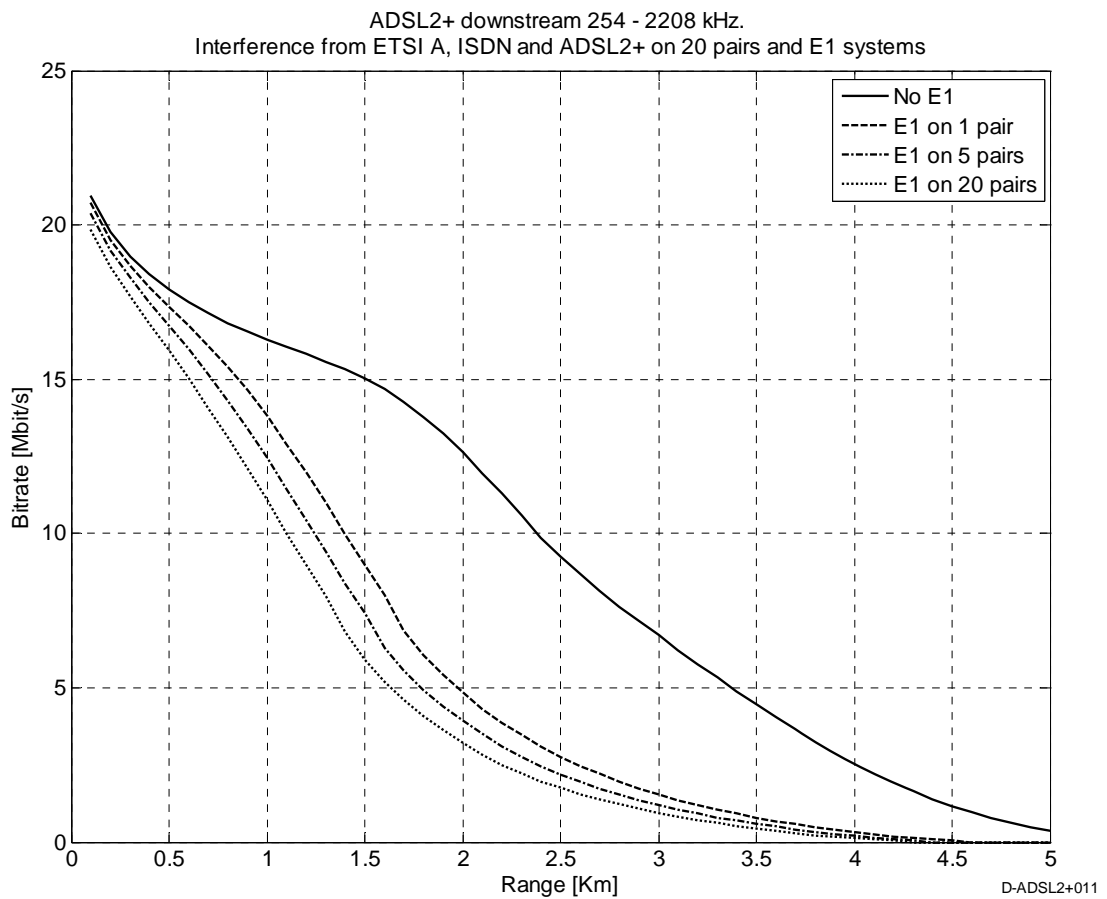


**Figure 6.42 Downstream ADSL2+. Interference from Three-pair HDSL with repeaters, varying number of disturbers.**

**6.3.8 Downstream ADSL2+ with interference from E1-systems (HDB3) with repeaters on 0, 1, 5 and 20 pairs**



**Figure 6.43 Downstream ADSL2+. Interference from E1-systems with repeaters, varying number of disturbers.**



**Figure 6.44 Downstream ADSL2+. Interference from E1-systems with repeaters, varying number of disturbers.**

#### **6.4 Upstream ADSL over ISDN (120 kHz – 276 kHz) with all DSLAMs in the local exchange**

This section shows the potential bitrate of upstream ADSL (ADSL/ADSL2+) over ISDN for different numbers of disturbing systems and for all major interfering systems in the Norwegian access network.

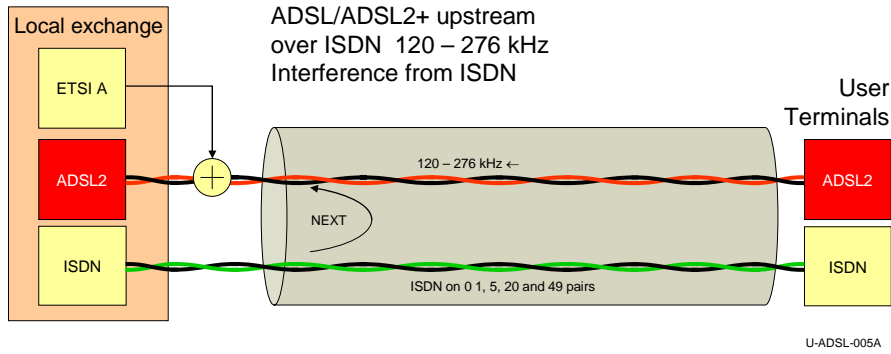
Figure 6.46 shows the performance with ETSI noise A as background noise and different numbers of ISDN systems. The degradation due to ISDN is negligible due to little spectral overlap for this case.

Figure 6.48 shows the potential bitrate of upstream ADSL for crosstalk from other ADSL systems. The background noise is ETSI noise A plus crosstalk from 20 ISDN systems. This shows that crosstalk from other ADSL systems is an important noise contribution, and that the potential bitrate is gradually reduced as the number of ADSL systems increases.

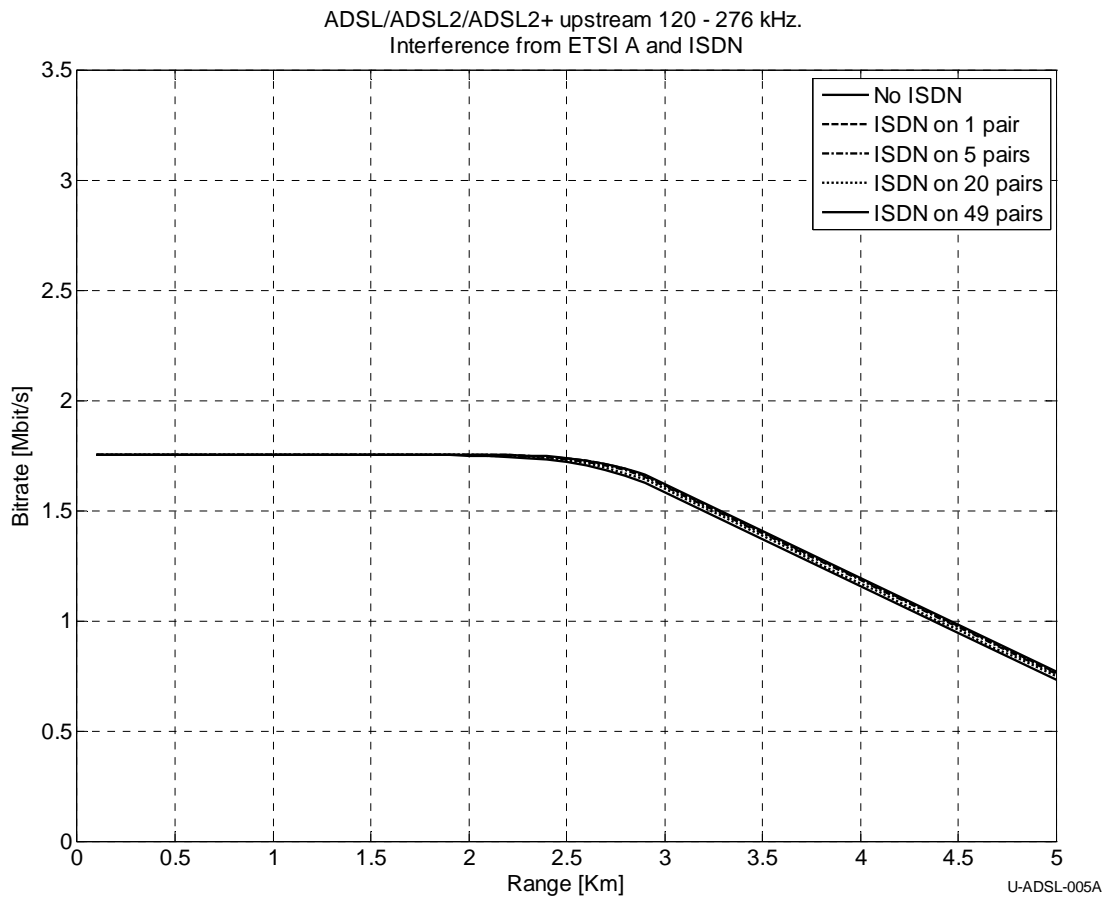
Figure 6.50 to Figure 6.53 shows the potential bitrate of upstream ADSL for crosstalk from SHDSL systems. The background noise is ETSI noise A plus crosstalk from 20 ISDN systems and 20 ADSL systems.

Figure 6.55 and Figure 6.56 show the potential bitrate of downstream ADSL for crosstalk from HDSL systems and from E1-systems. The background noise is the same as for SHDSL. HDSL causes almost the same degradation of ADSL as SHDSL. The degradations due to E1-systems are small due to low spectra density of E1 in the ADSL upstream band.

**6.4.1 Upstream ADSL over ISDN with interference from ISDN**

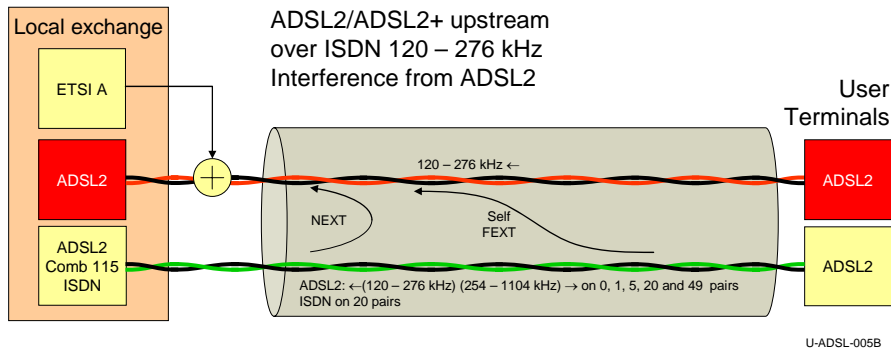


**Figure 6.45 Upstream ADSL over ISDN. Interference from ISDN, varying number of disturbers.**

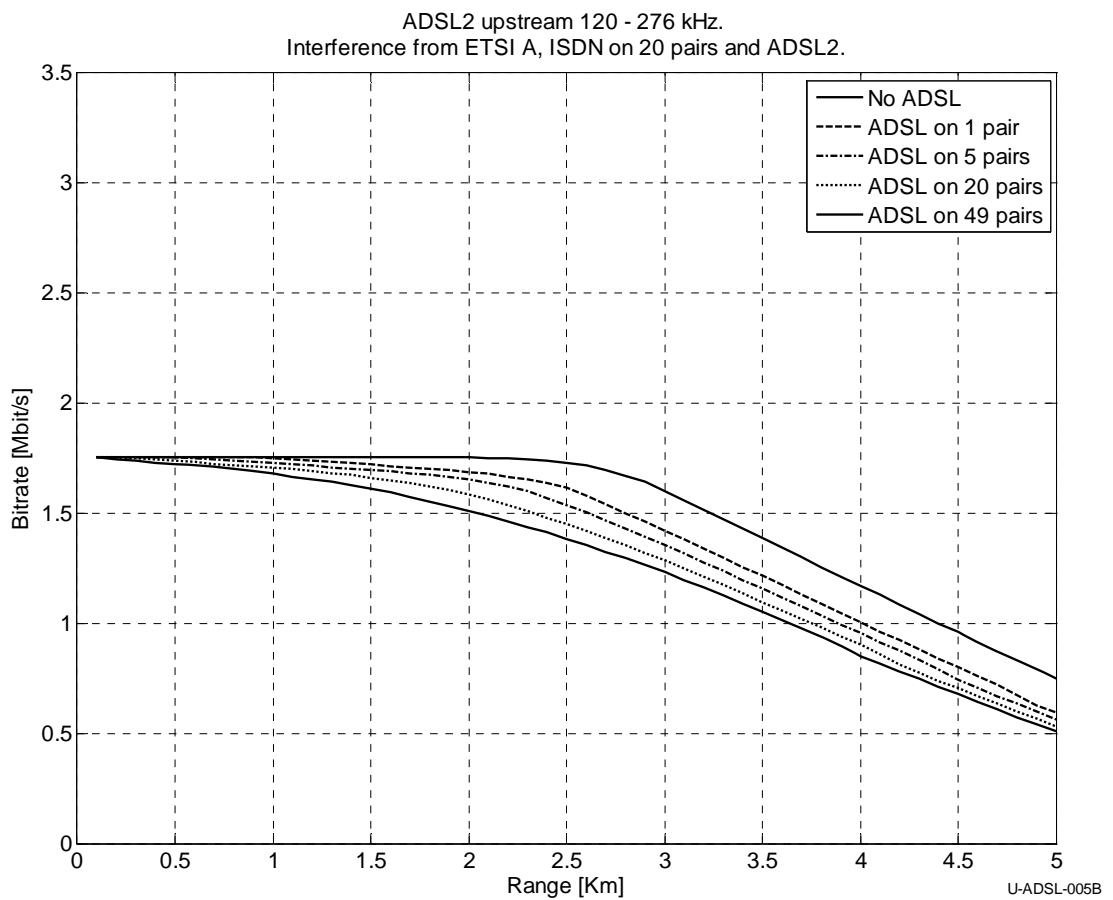


**Figure 6.46 Upstream ADSL over ISDN. Interference from ISDN, varying number of disturbers.**

**6.4.2 Upstream ADSL over ISDN with interference from ADSL**

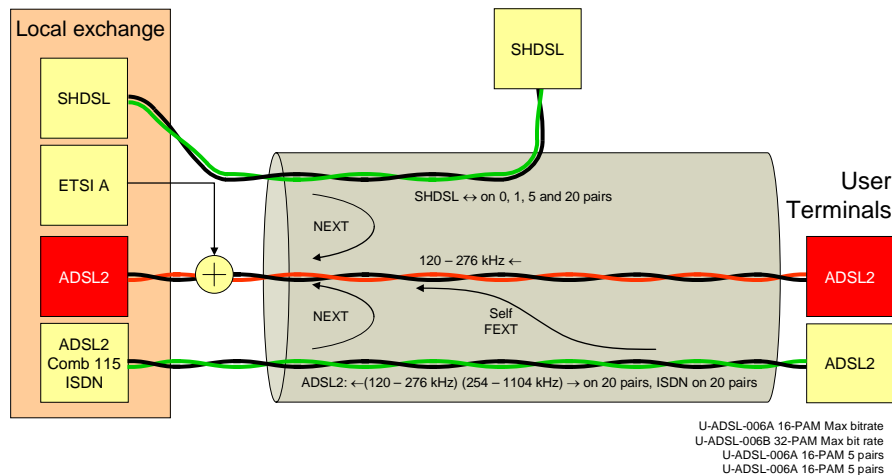


**Figure 6.47 Upstream ADSL over ISDN. Interference from ADSL, varying number of disturbers.**



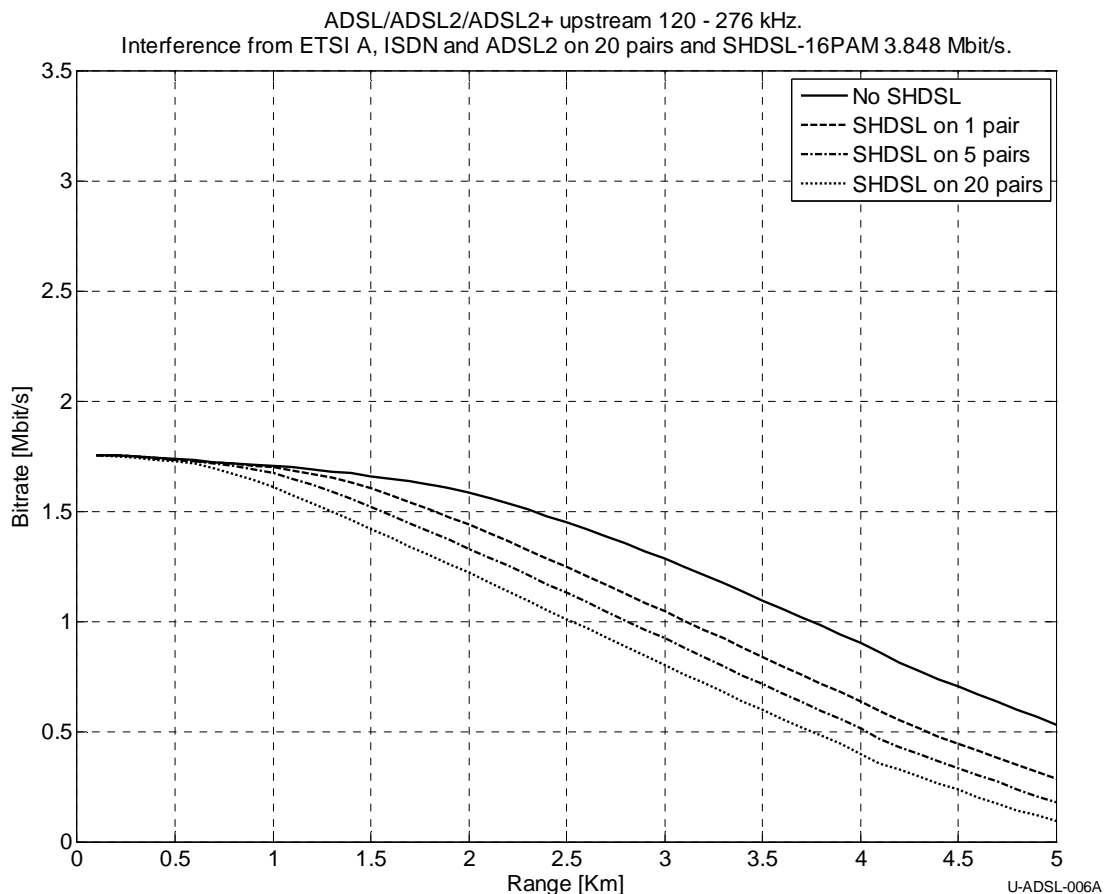
**Figure 6.48 Upstream ADSL over ISDN. Interference from ADSL.**

**6.4.3 Upstream ADSL over ISDN with interference from SHDSL**



**Figure 6.49 Upstream ADSL over ISDN. Interference from SHDSL.**

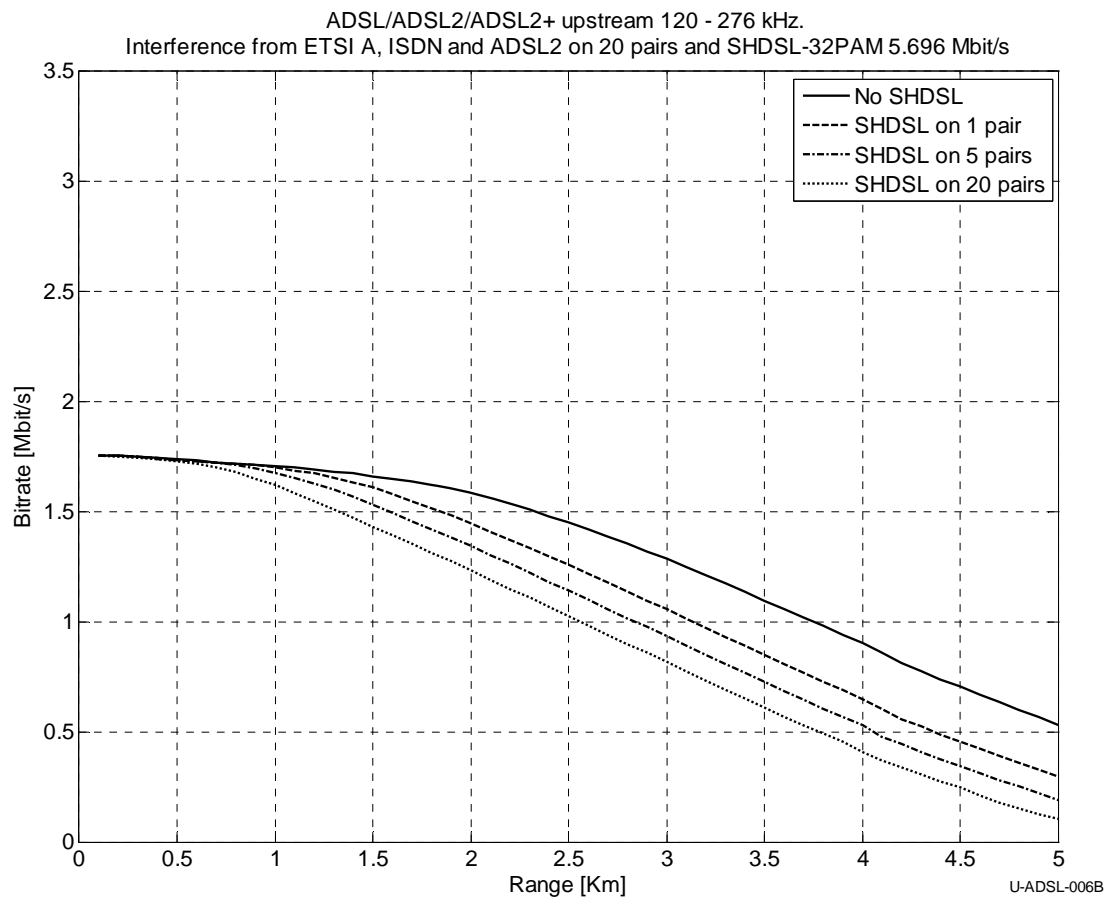
**6.4.3.1 Upstream ADSL over ISDN with interference from SHDSL 16-PAM 3.848 Mbit/s**



**Figure 6.50 Upstream ADSL over ISDN. Interference from SHDSL 16-PAM, varying number of disturbers.**

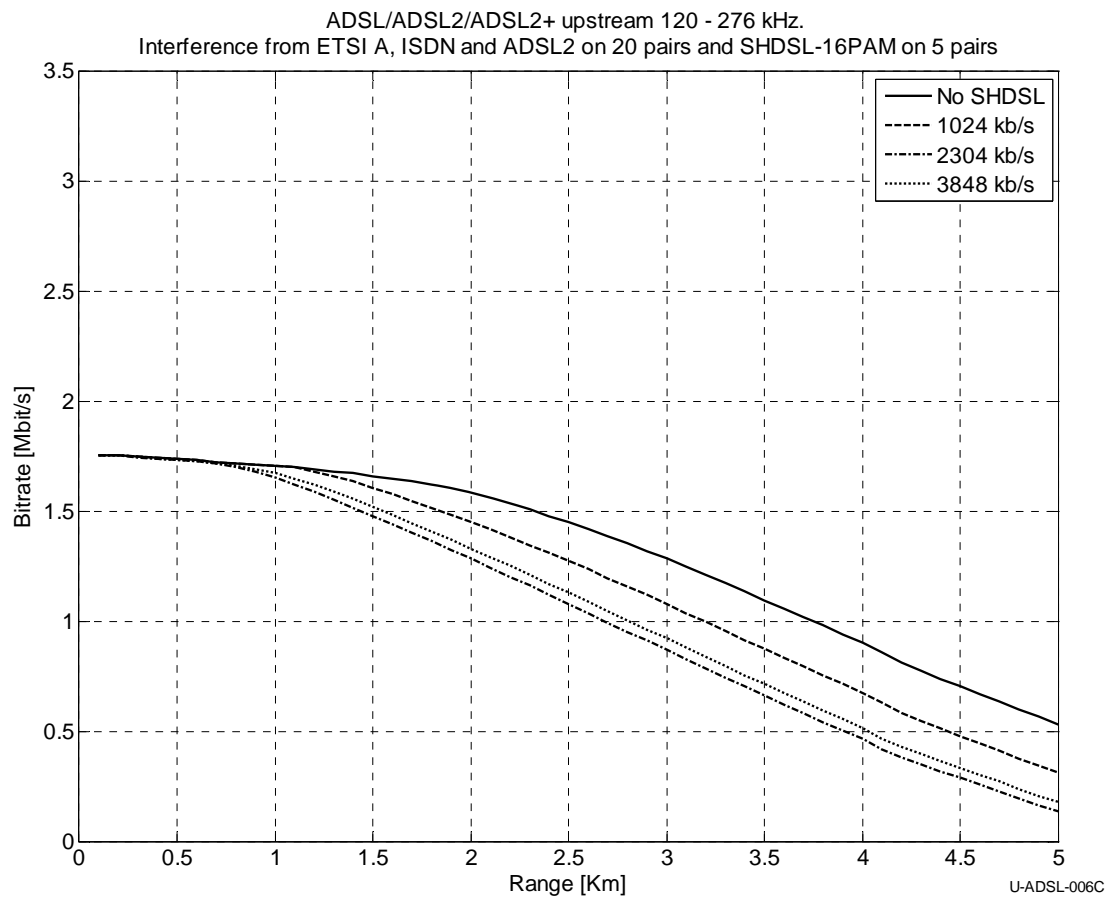


### 6.4.3.2 Upstream ADSL over ISDN with interference from SHDSL 32-PAM 5.696 Mbit/s



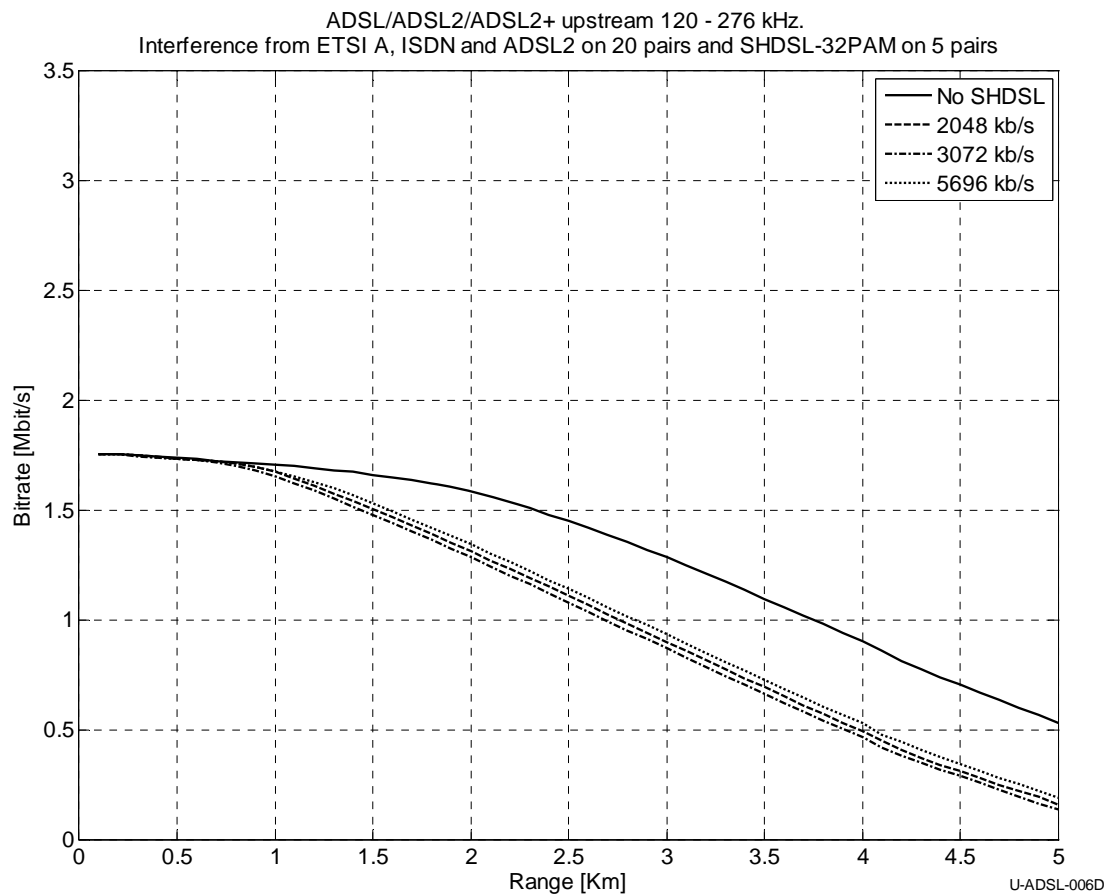
**Figure 6.51 Upstream ADSL over ISDN. Interference from SHDSL 32-PAM, varying number of disturbers.**

### 6.4.3.3 Upstream ADSL over ISDN with interference from SHDSL 16-PAM on 5 pairs



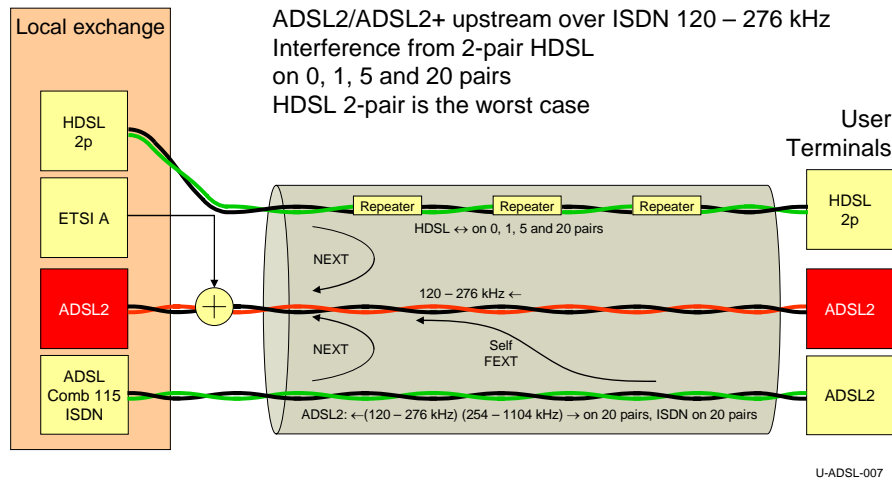
**Figure 6.52 Upstream ADSL over ISDN. Interference from SHDSL 16-PAM, varying bitrate.**

### 6.4.3.4 Upstream ADSL over ISDN with interference from SHDSL 32-PAM on 5 pairs

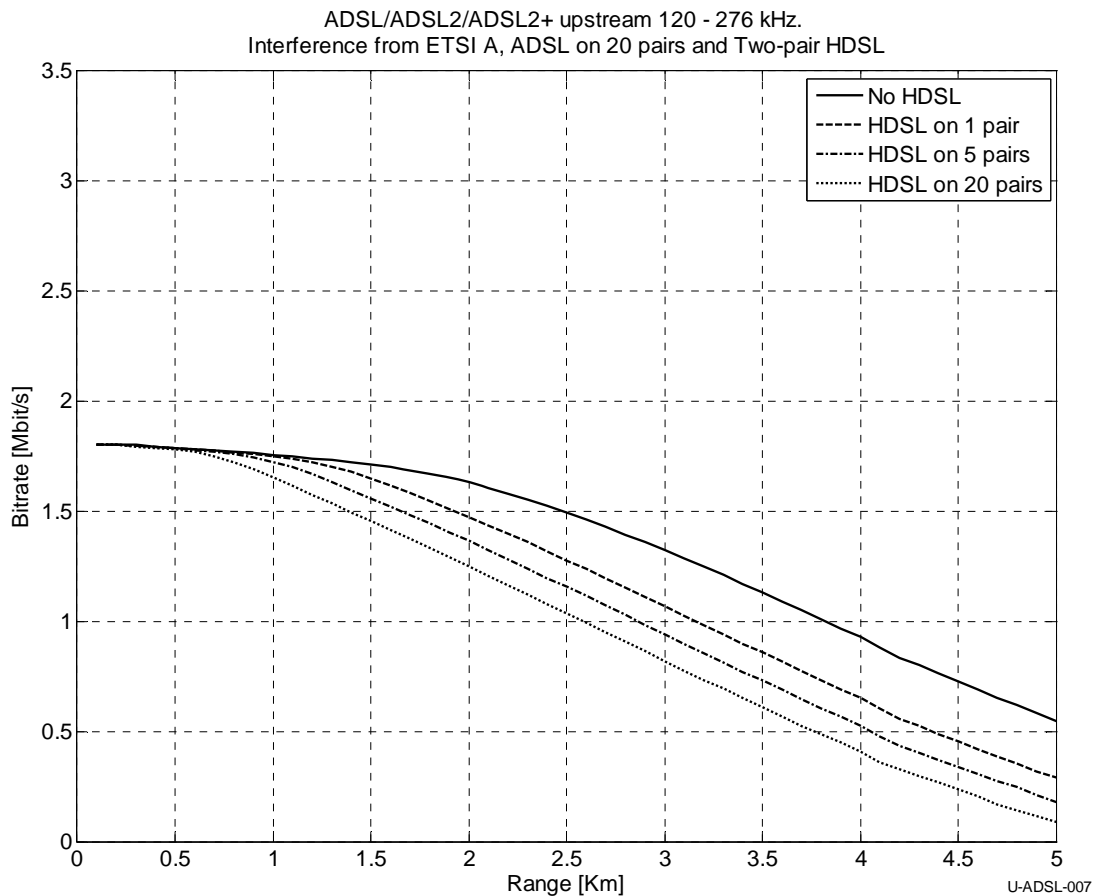


**Figure 6.53 Upstream ADSL over ISDN. Interference from SHDSL 32-PAM, varying bitrate.**

**Upstream ADSL over ISDN with interference from HDSL**



**Figure 6.54 Upstream ADSL over ISDN. Interference from HDSL, varying number of disturbers.**



**Figure 6.55 Upstream ADSL over ISDN. Interference from Two-pair HDSL, varying number of disturbers.**

6.4.4 Upstream ADSL over ISDN with interference from E1-systems

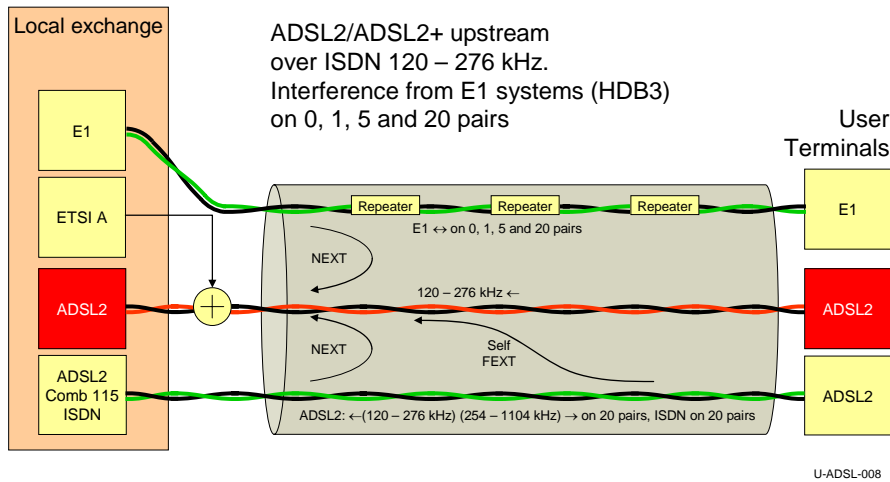


Figure 6.56 Upstream ADSL over ISDN. Interference from E1-systems, varying number of disturbers.

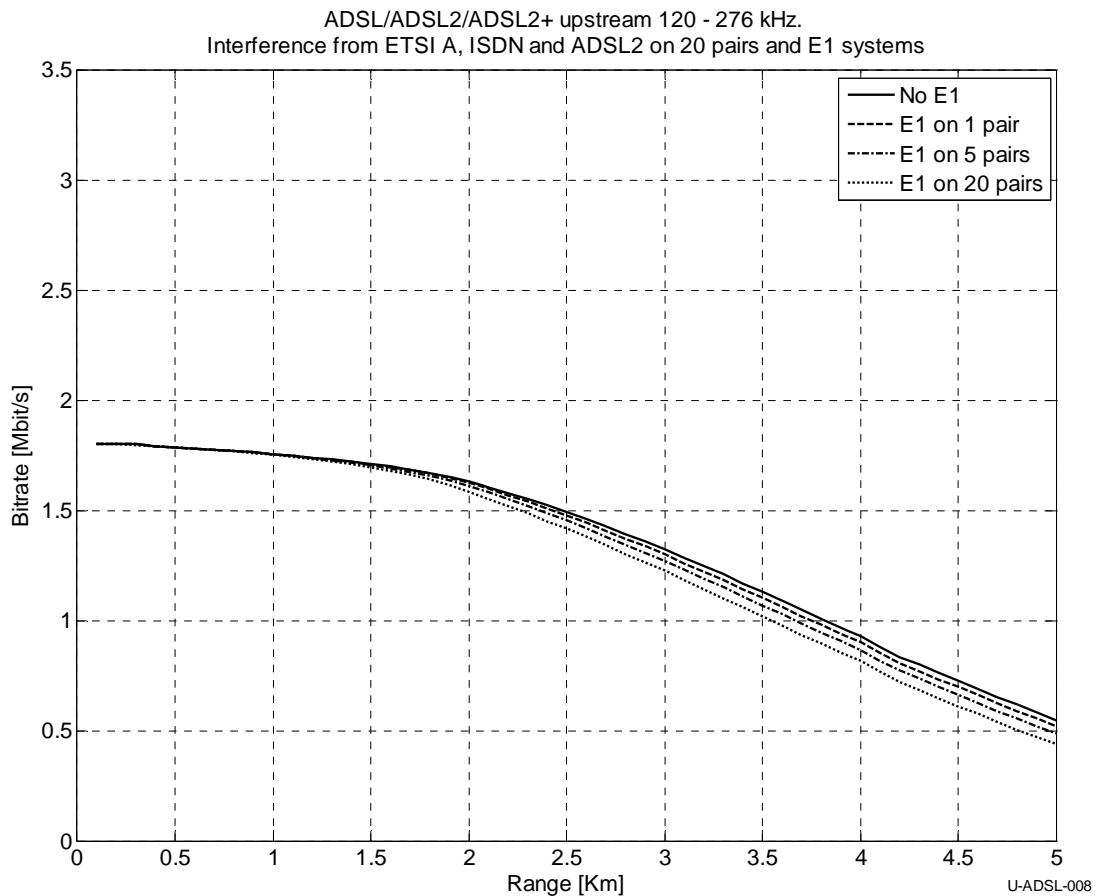
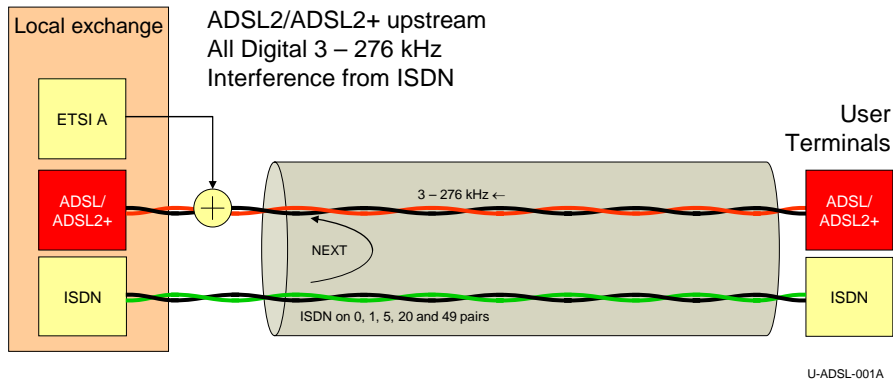


Figure 6.57 Upstream ADSL over ISDN. Interference from E1-systems, varying number of disturbers.

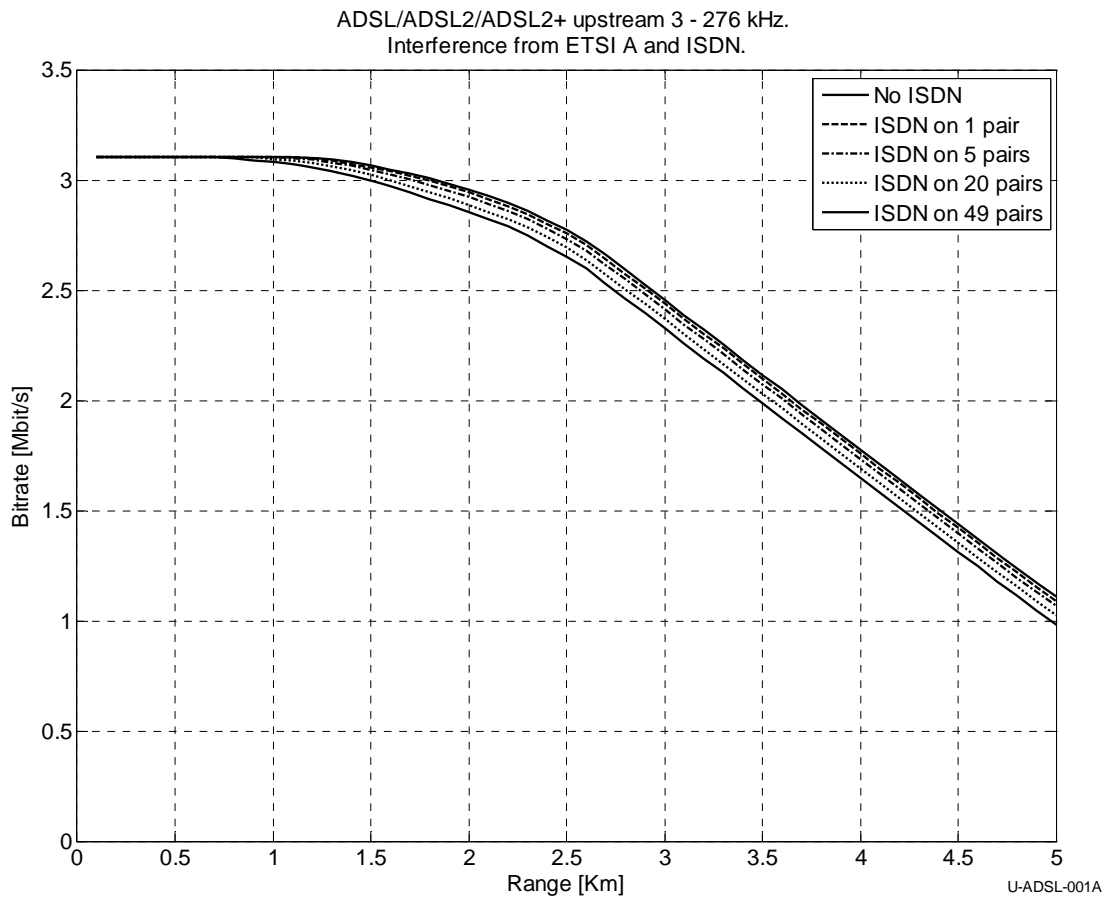
### **6.5 Upstream All Digital ADSL (3 – 276 kHz) with all DSLAMs in the local exchange**

This section shows the potential bitrate of upstream All Digital ADSL (ADSL or ADSL2+) for different numbers of disturbing systems and for all major interfering systems in the Norwegian access network. The bitrates of All Digital ADSL are higher than for ADSL over ISDN due to the larger upstream bandwidth. There are only minor differences for upstream transmission between All Digital ADSL and ADSL over ISDN. One difference is interference from ISDN, because there is significant overlap between All Digital ADSL and ISDN. However, the crosstalk coupling is small in the frequency band of interest, so that the degradation of ADSL due to ISDN is small also for All Digital ADSL. Except for this, the reader is referred to the main comments for upstream ADSL over ISDN given in Section 6.4 also for All Digital ADSL and the detailed results for All Digital ADSL given below.

**6.5.1 Upstream All Digital ADSL with interference from ISDN**

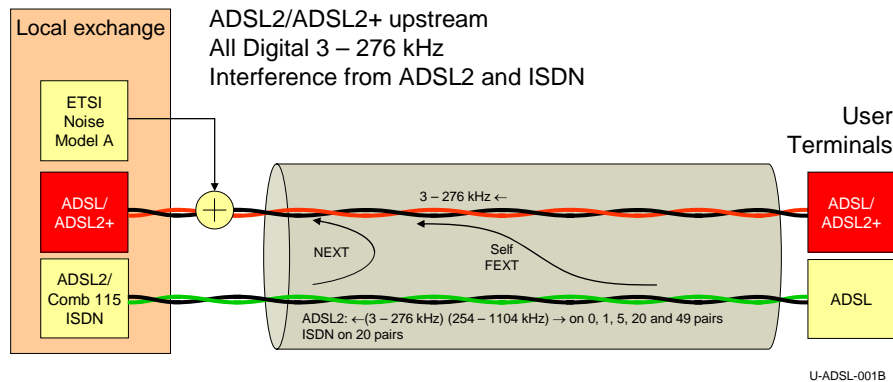


**Figure 6.58 Upstream All Digital ADSL. Interference from ISDN.**

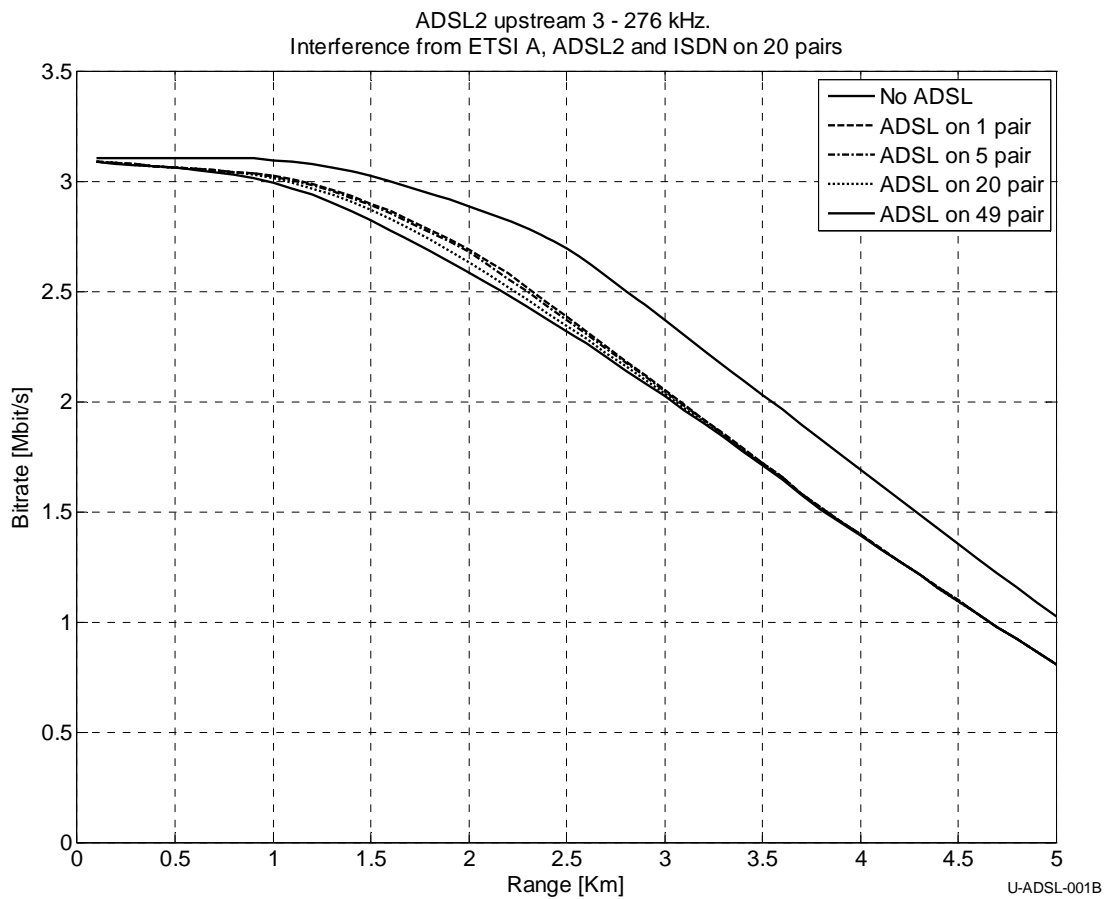


**Figure 6.59 Upstream All Digital ADSL. Interference from ISDN.**

**6.5.2 Upstream All Digital ADSL2 with interference from ISDN and ADSL**



**Figure 6.60 Upstream All Digital ADSL. Interference from ISDN and ADSL.**

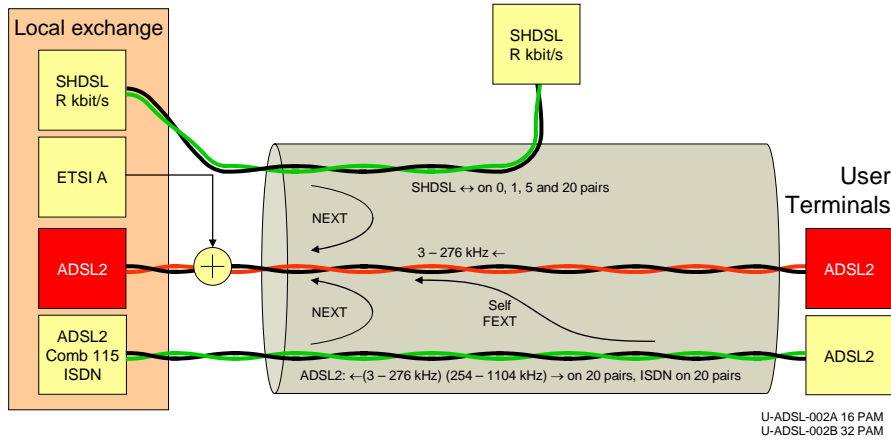


**Figure 6.61 Upstream All Digital ADSL. Interference from ISDN and ADSL.**



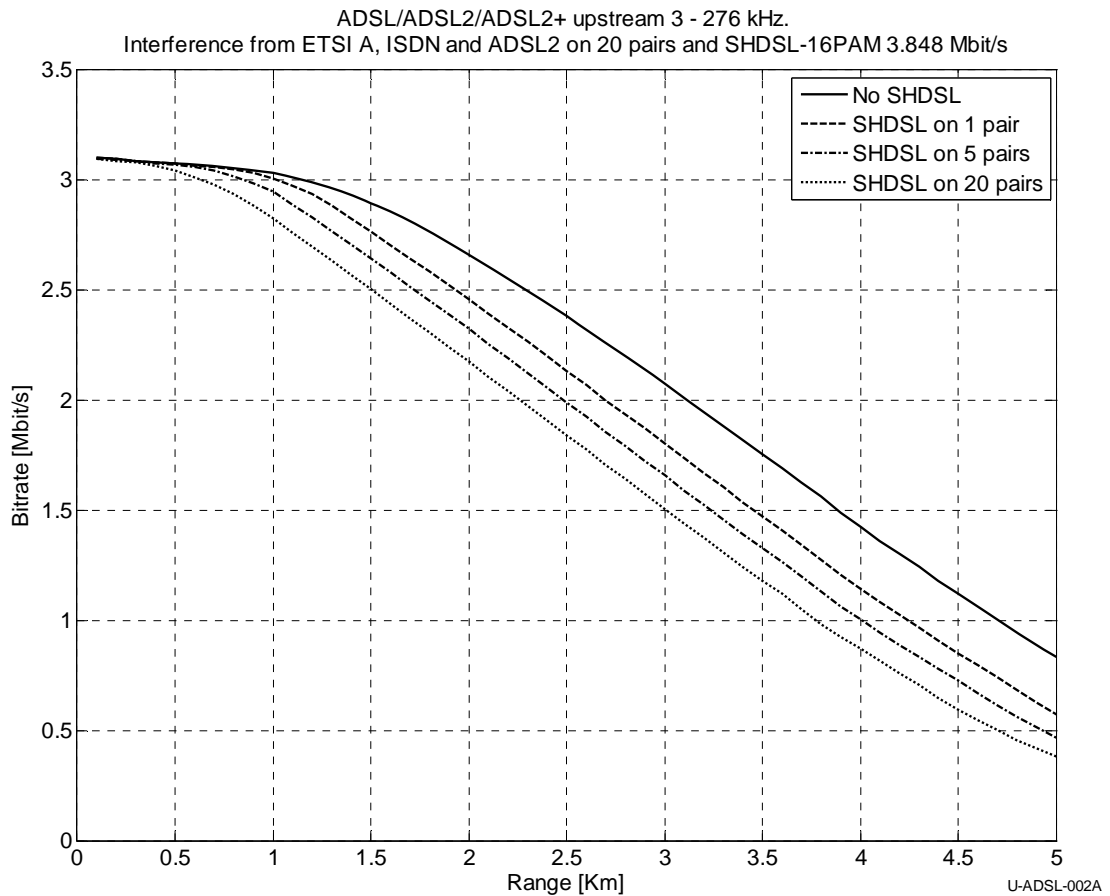
**6.5.3 Upstream All Digital ADSL with interference from SHDSL**

ADSL2/ADSL2+ upstream  
 All Digital 3 – 276 kHz  
 Interference from SHDSL 16 TCPAM  
 on 0, 1, 5 and 20 pairs



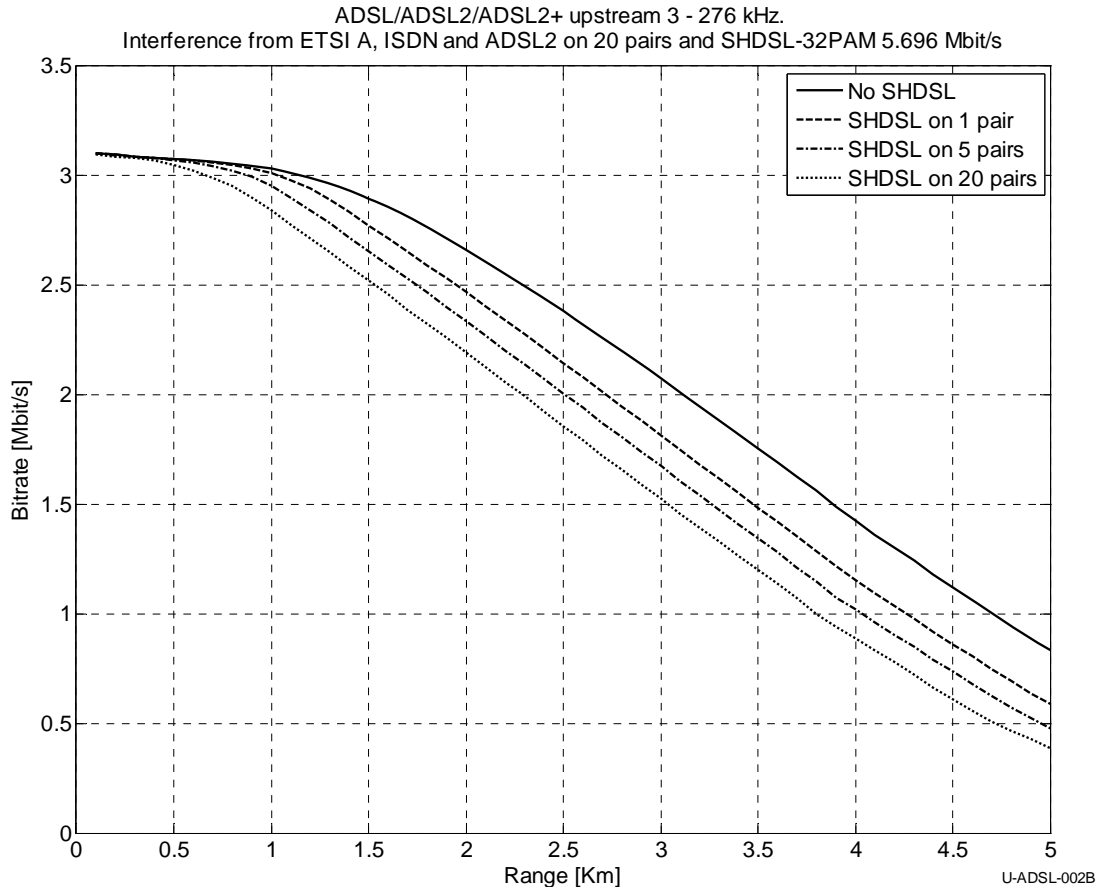
**Figure 6.62 Upstream All Digital ADSL. Interference from SHDSL 16-PAM.**

**6.5.3.1 Upstream All Digital ADSL with interference from SHDSL 16-PAM 3.848 Mbit/s, varying number of disturbers**



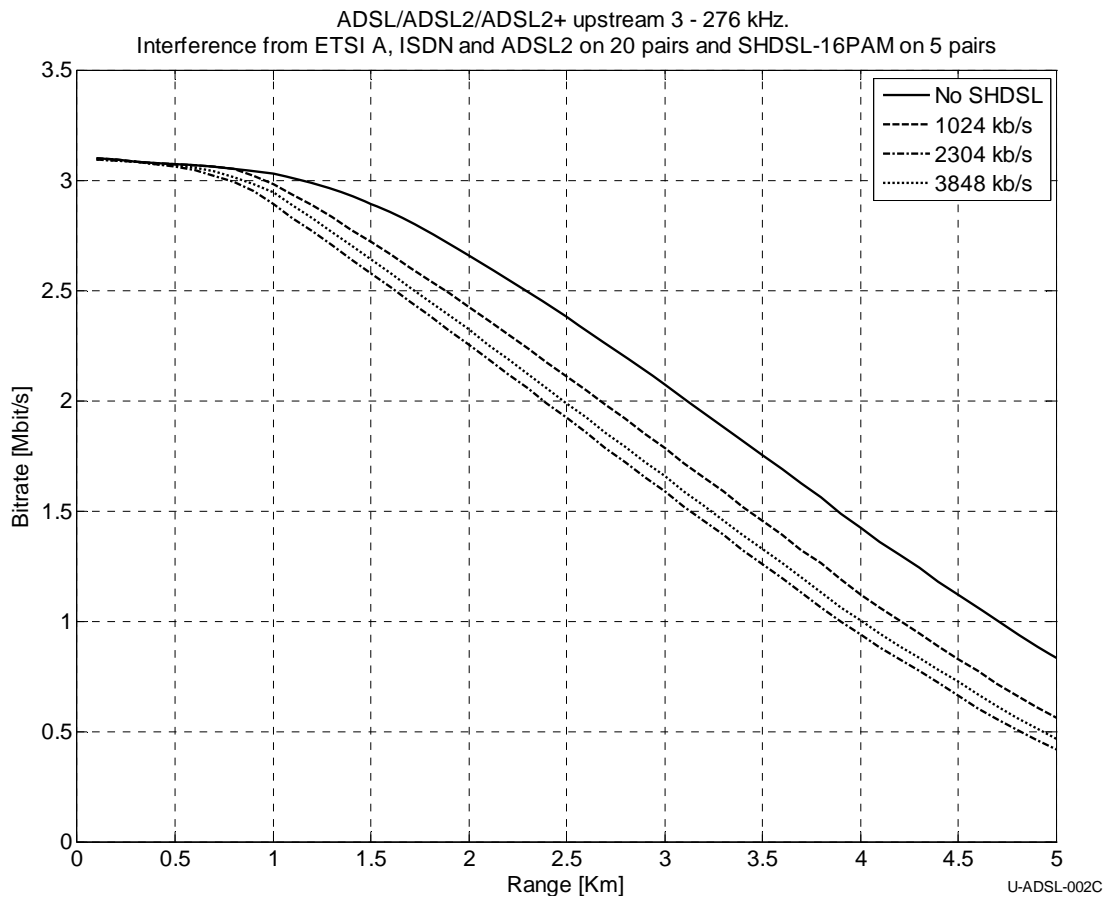
**Figure 6.63 Upstream All Digital ADSL. Interference from SHDSL 16-PAM. Varying number of disturbers.**

**6.5.3.2 Upstream All Digital ADSL with interference from SHDSL 32-PAM 5.696 Mbit/s, varying number of disturbers**



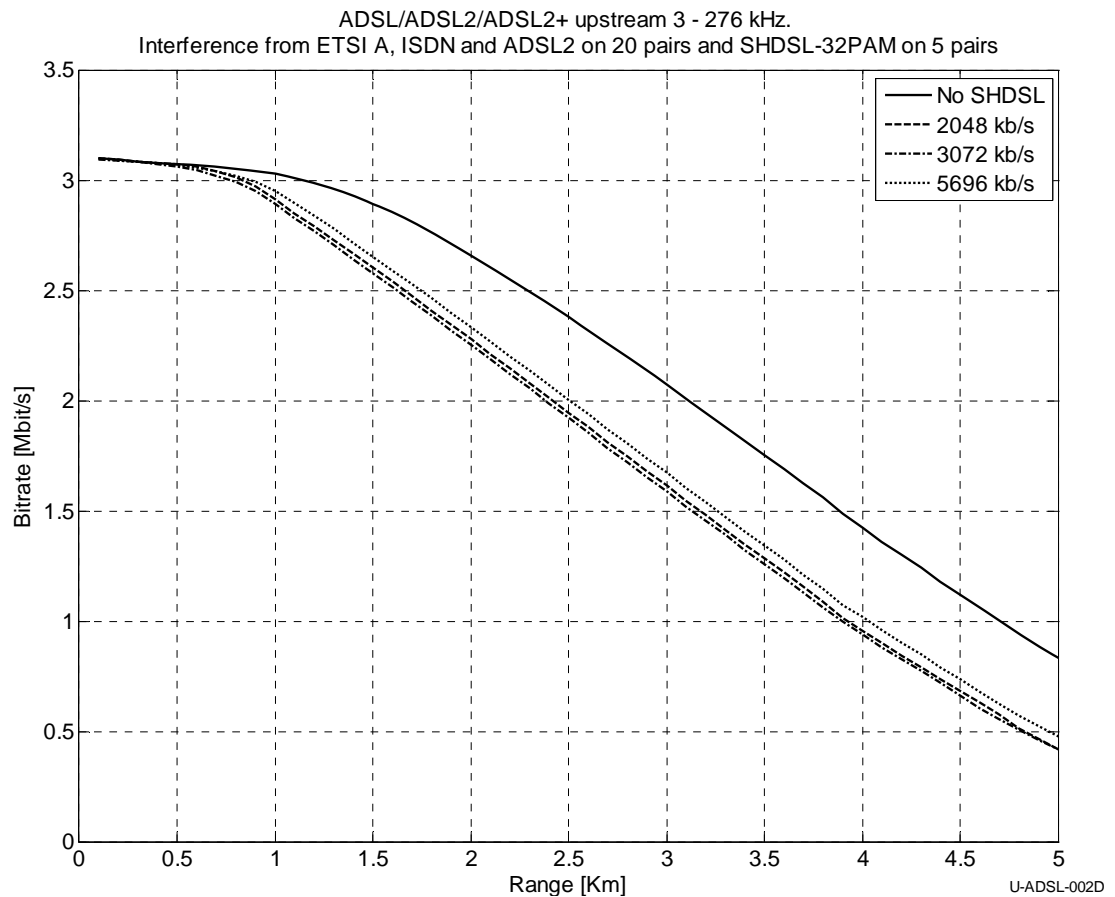
**Figure 6.64 Upstream All Digital ADSL. Interference from SHDSL 32-PAM. Varying number of disturbers.**

**6.5.3.3 Upstream All Digital ADSL with interference from SHDSL 16-PAM on 5 pairs, varying bitrate**



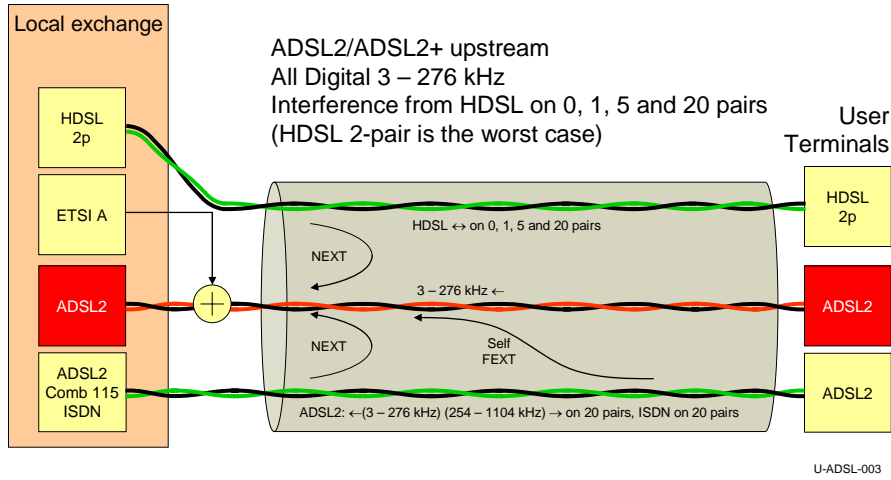
**Figure 6.65 Upstream All Digital ADSL. Interference from SHDSL 32-PAM. Varying bitrate.**

### 6.5.3.4 Upstream All Digital ADSL with interference from SHDSL 32-PAM on 5 pairs, varying bitrate

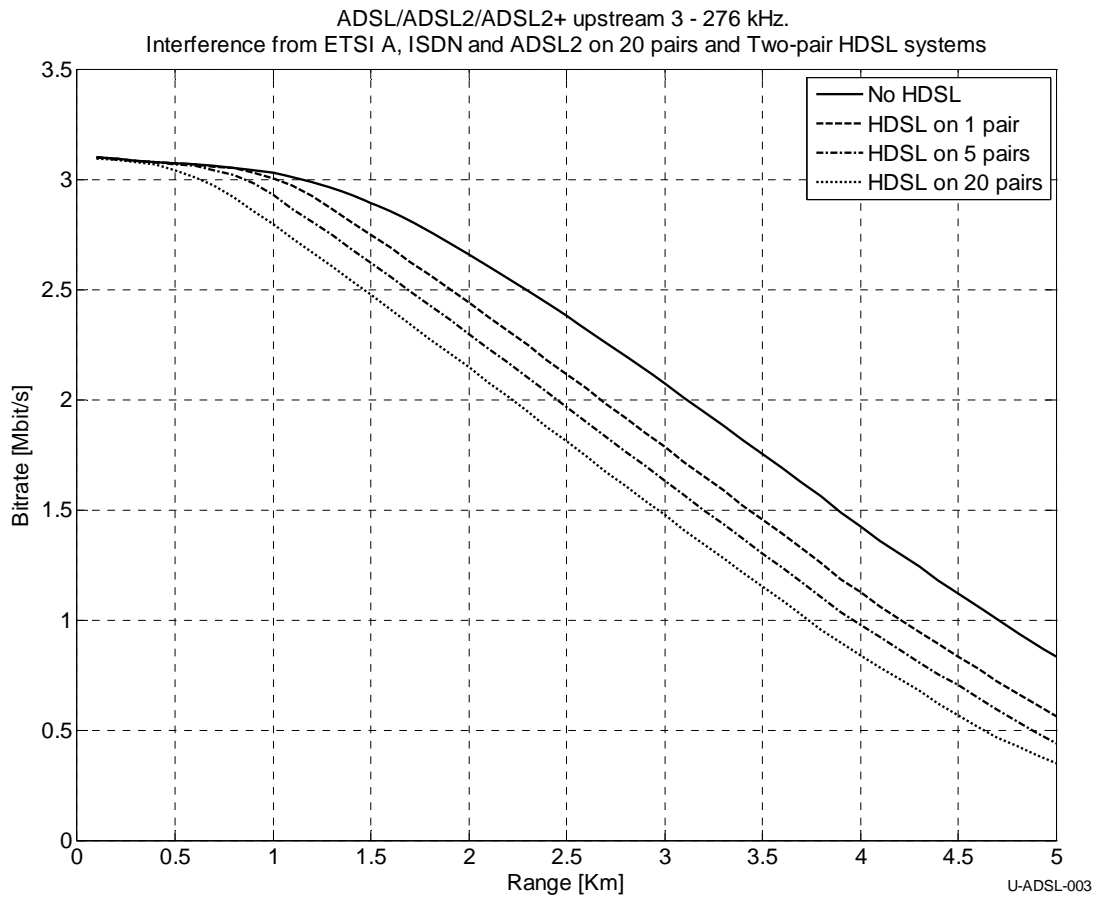


**Figure 6.66 Upstream All Digital ADSL. Interference from SHDSL 32-PAM, varying bitrate.**

**6.5.4 Upstream All Digital ADSL with interference from HDSL**

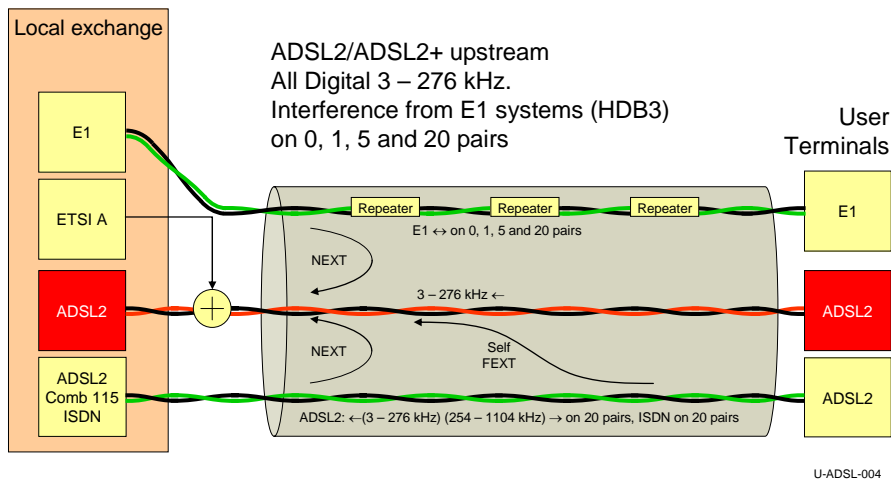


**Figure 6.67 Upstream All Digital ADSL. Interference from Two-pair HDSL.**

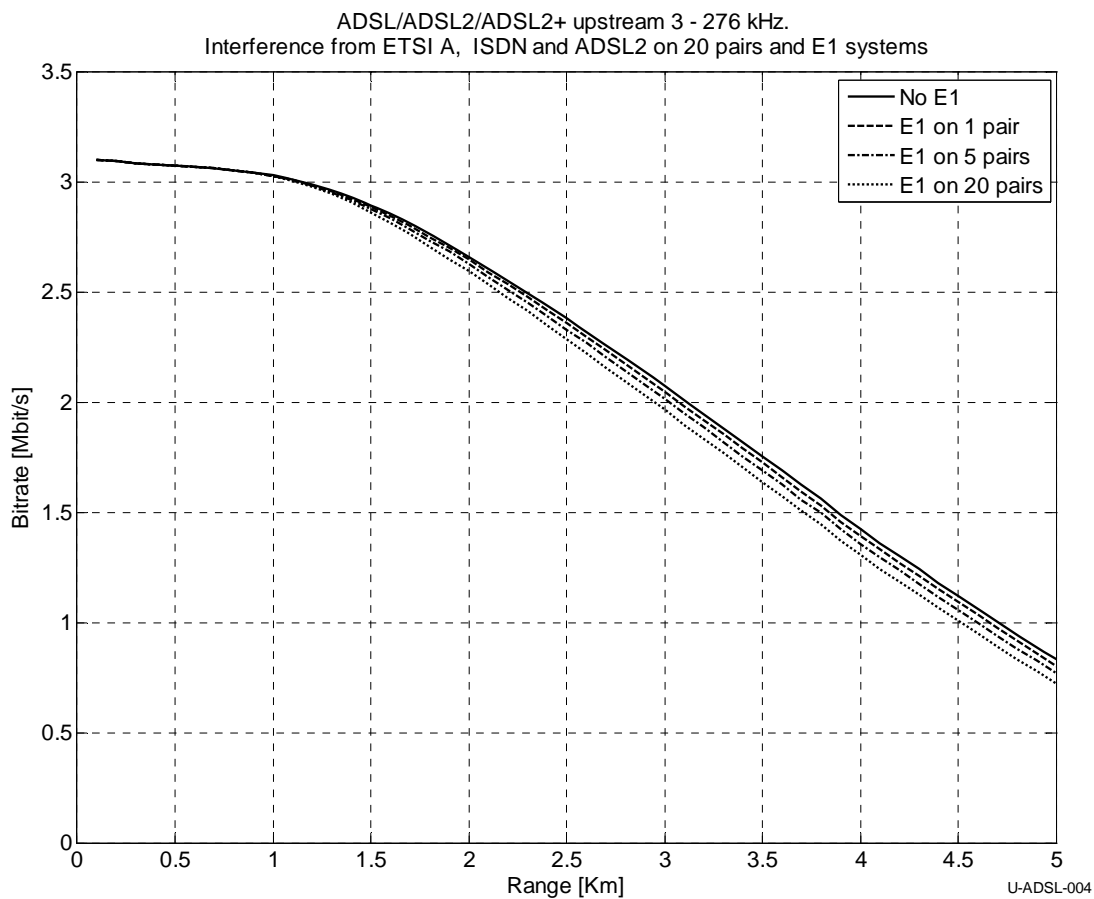


**Figure 6.68 Upstream All Digital ADSL. Interference from Two-pair HDSL.**

**6.5.5 Upstream All Digital ADSL with interference from E1-systems with repeaters**



**Figure 6.69 Upstream All Digital ADSL. Interference from E1-systems.**



**Figure 6.70 Upstream All Digital ADSL2. Interference from E1-systems.**

## 7 Simulation results for ADSL subloop

Subloop means that a DSLAM is installed further downstream than the main DSLAMs, which are typically located in the local exchange. An illustration is given in Figure 7.1. The subloop DSL systems enter strong signals into the cable at a point where the local exchange DSL downstream signal level has been attenuated. Hence, the performance of the systems from the local exchange may be severely reduced. One way to prevent this type of degradation is to use power backoff (power cutback) in the subloop systems.

The purpose of this section is to analyse the effect of using subloop for ADSL systems for the case that power backoff is not used. Different combinations of ADSL and ADSL2+ systems have been analyzed, where nominal power spectral density is assumed for all systems. No backoff schemes have been analyzed.

When power backoff is not used, the downstream direction of the subloop system will operate in a less critical situation than the situation analysed in Section 6. In section 6 it is assumed that all DSLAMs are located in the local exchange, and the reader is referred to the results in this section also for the downstream direction of the subloop system. However, the performance of the downstream direction of systems from the local exchange is heavily affected by the subloop systems, and this is analysed in Sections 7.1 and 7.2.

The consequences for subloop ADSL for the upstream and downstream directions are different. ADSL systems will have no power backoff in the upstream direction. This means that ADSL systems will usually transmit with full power spectrum from most distances. This effect has been analyzed and the results are presented in Sections 6.4 and 6.5. Using ADSL2+ subloop will cause the same type of interference into the upstream direction of ADSL, because spectra for ADSL and ADSL2+ are identical. The reader is referred to Sections 6.4 and 6.5 for all types of upstream ADSL with subloop.

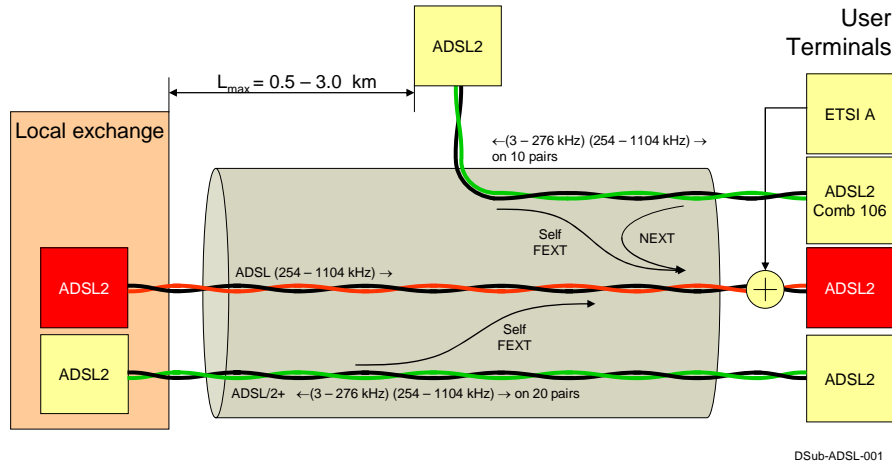
### 7.1 Downstream ADSL from local exchange (254 – 1104 kHz) with subloop interference

Figure 7.2 show the potential bitrate of downstream ADSL disturbed by ADSL subloop in 10 pairs. The background noise is ETSI noise A plus 20 disturbing ADSL systems from the local exchange. The reduction in bitrate is quite significant already for a subloop at 0.5 km from the local exchange. One illustrating example is a customer 3.5 km from the local exchange. The potential bitrate will be reduced from approximately 4.5 to 0.3 Mbit/s by a subloop at 3 km from the local exchange. Figure 7.3, Figure 7.4 and Figure 7.5 show the same situation for subloop at 0.75, 1.5 and 2.5 km and varying number of subloop disturbers. This confirms that the degradation due to subloop is significant already for one disturber. ADSL subloop without backoff should therefore be used with great care.

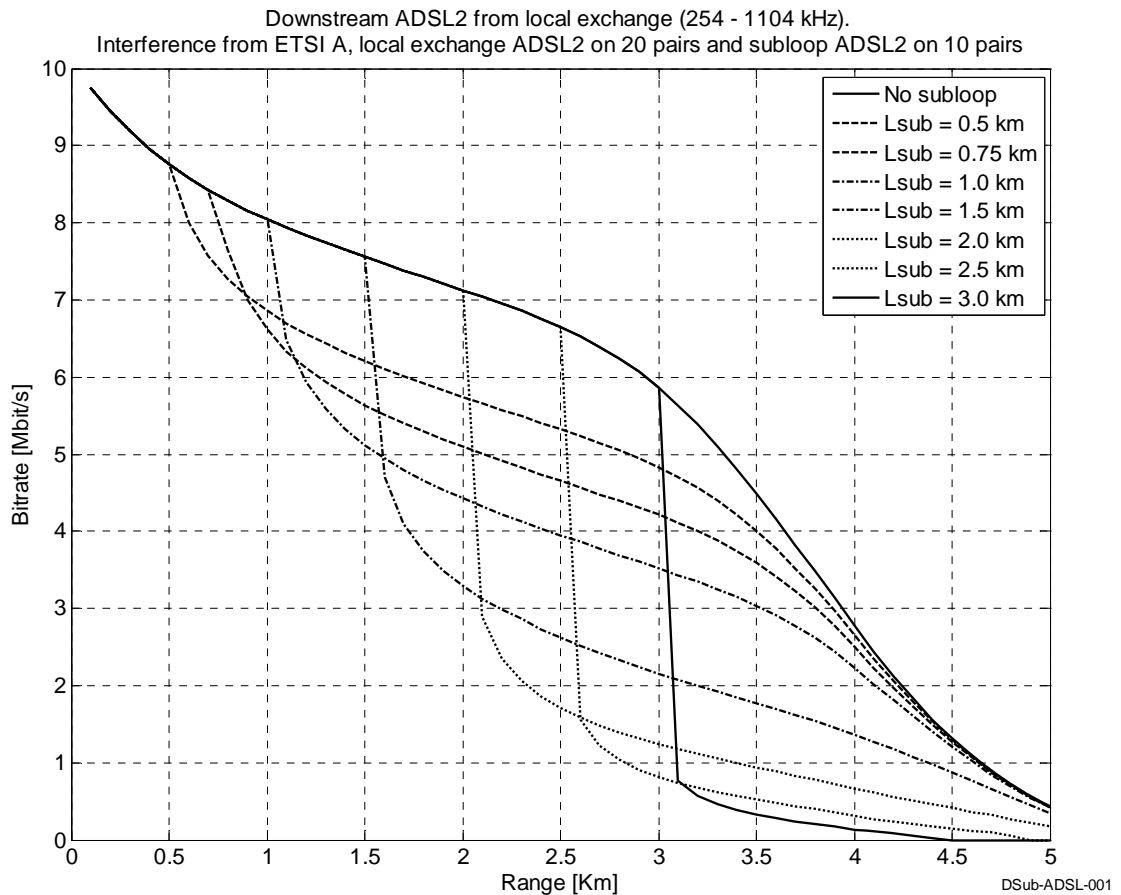
The situation that ADSL is disturbed by ADSL2+ subloop has not been analyzed. The transmitted spectrum of ADSL2+ will be almost the same as for ADSL within the downstream band of ADSL. Hence, the results will be approximately the same as for ADSL subloop.

**7.1.1 Downstream ADSL with interference from subloop ADSL on 10 pairs**

ADSL2 downstream from local exchange.  
 Interference from subloop ADSL2 on 10 pairs  
 Background noise: Local exchange ADSL2 on 20 pairs and ETSI A  
 $L_{sub} = 0.5, 0.75, 1.0, 1.5, 2.0, 2.5$  and  $3.0$  km



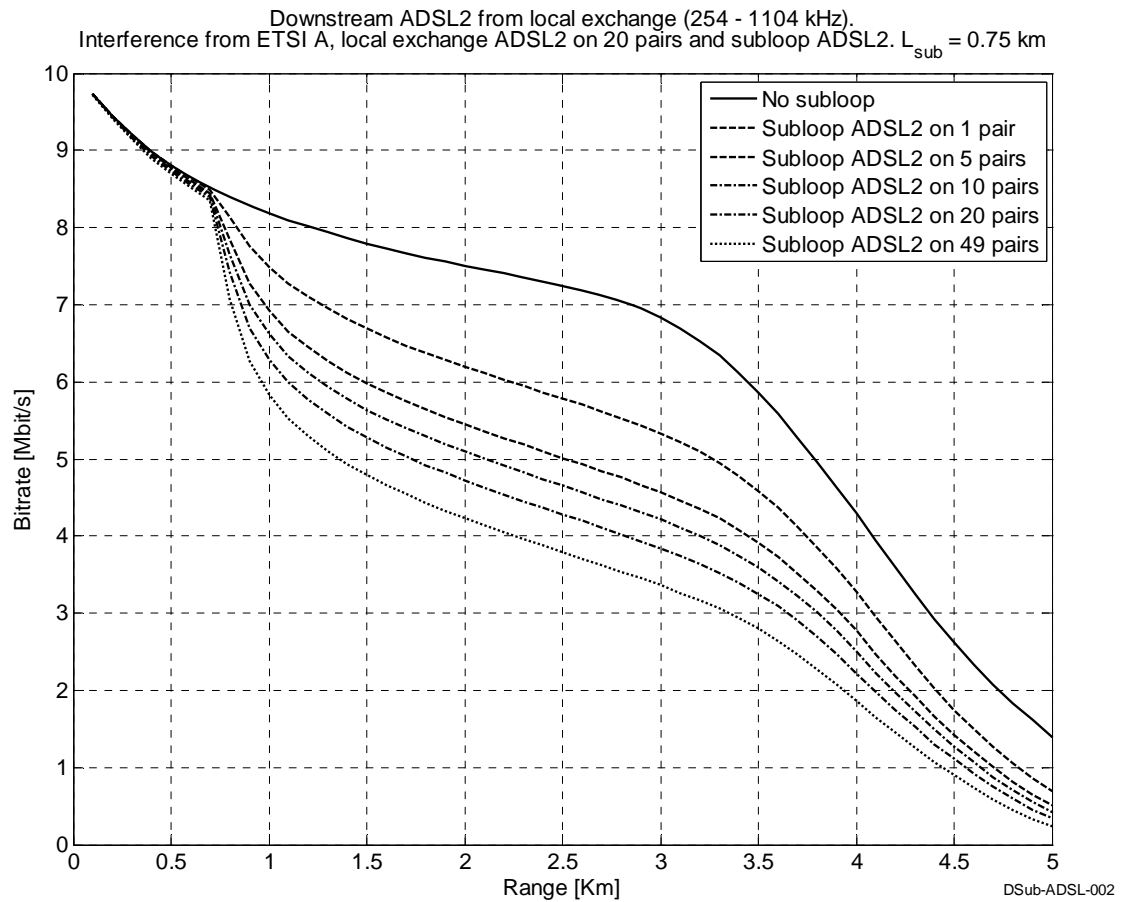
**Figure 7.1 Downstream ADSL. Interference from subloop ADSL.**



**Figure 7.2 Downstream ADSL. Interference from ADSL. Varying subloop length.**

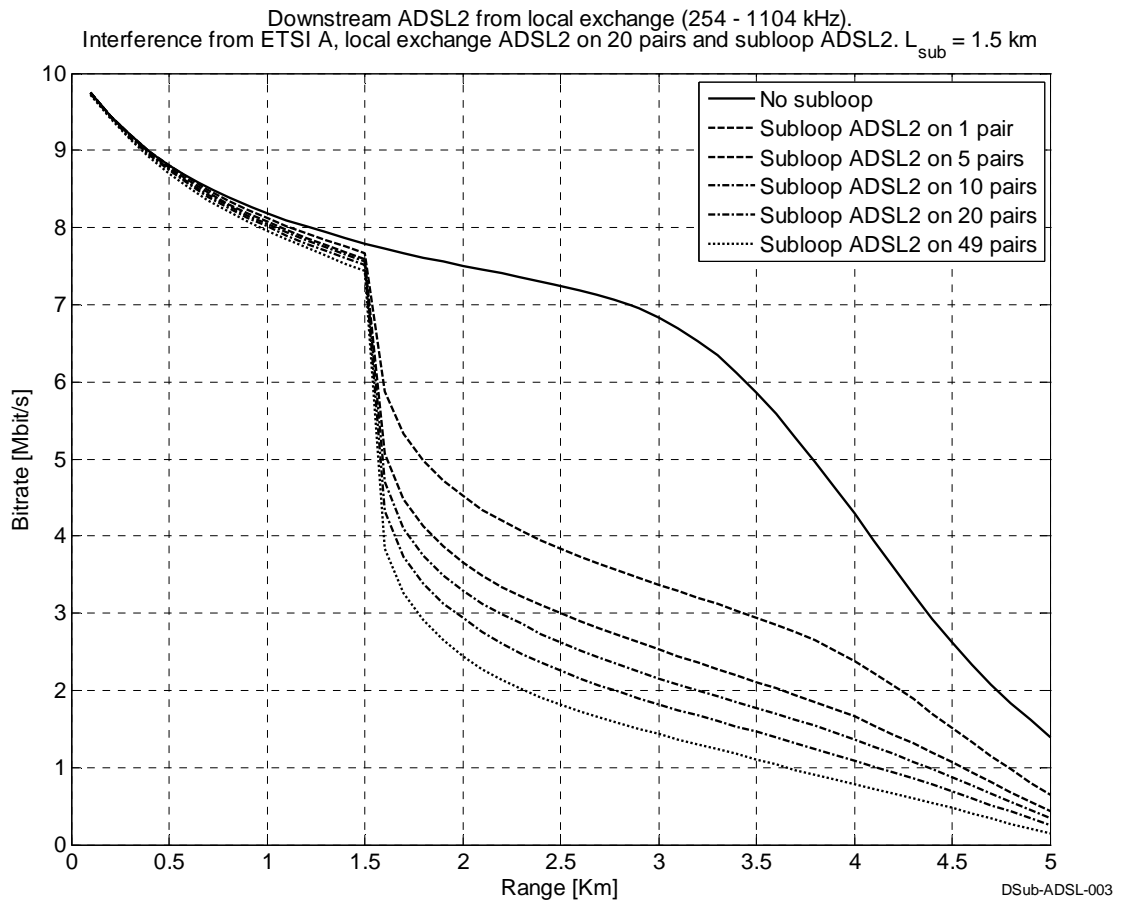


### 7.1.2 Downstream ADSL with interference from subloop ADSL on varying number of pairs



**Figure 7.3 Downstream ADSL. Interference from ADSL, varying number of disturbers.  $L_{\text{sub}} = 0.75$  km.**

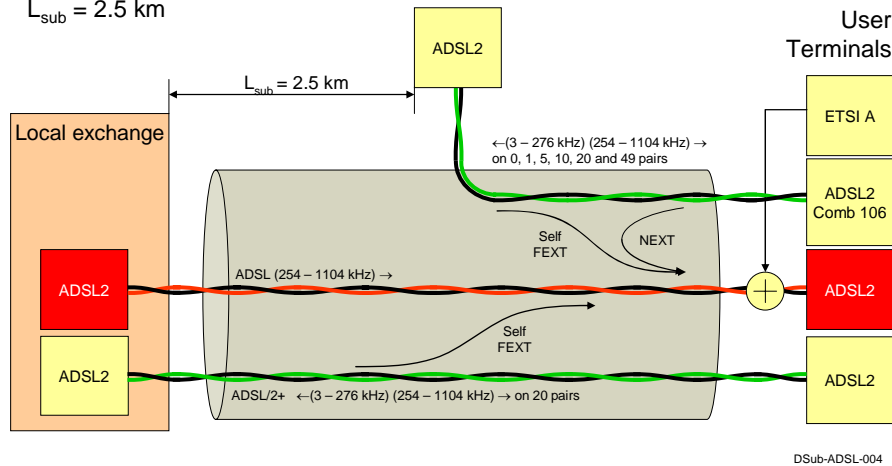
**7.1.3 Downstream ADSL with interference from subloop ADSL on varying number of pairs**



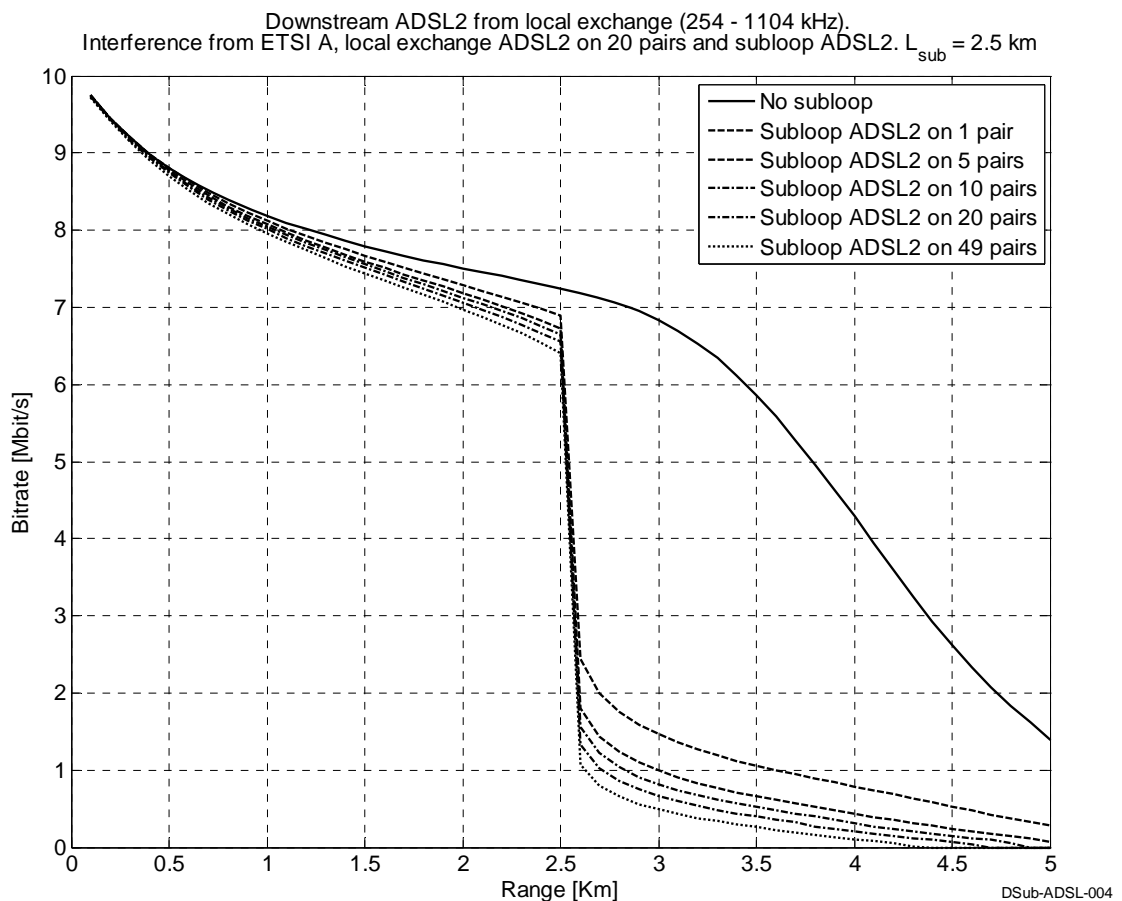
**Figure 7.4 Downstream ADSL. Interference from ADSL, varying number of disturbers.  $L_{sub} = 1.5$  km.**

### 7.1.4 Downstream ADSL with interference from subloop ADSL on varying number of pairs

ADSL2 downstream from local exchange.  
 Interference from subloop ADSL2 on 0, 1, 5, 10, 20, and 49 pairs  
 Background noise: Local exchange ADSL2 on 20 pairs and ETSI A  
 $L_{sub} = 2.5$  km



**Figure 7.5 Downstream ADSL. Interference from subloop ADSL.**



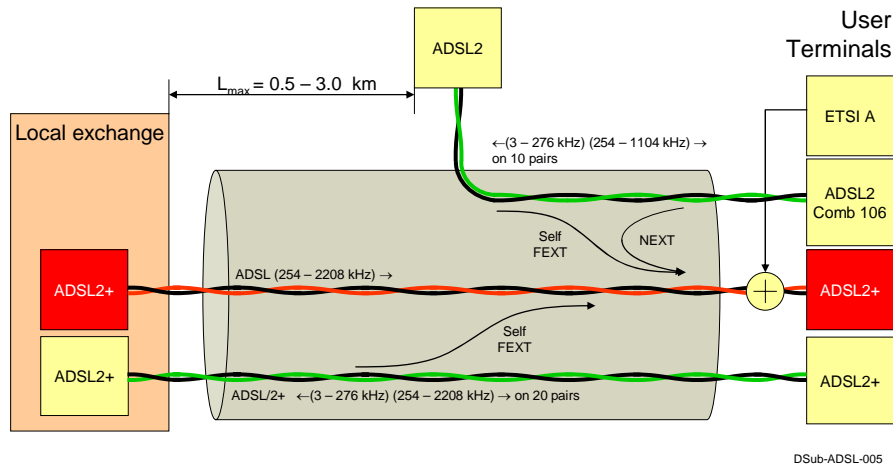
**Figure 7.6 Downstream ADSL. Interference from ADSL, varying number of disturbers.**  
 $L_{sub} = 2.5$  km.

## **7.2 Downstream ADSL2+ from local exchange (254 – 2208 kHz) with subloop interference from ADSL**

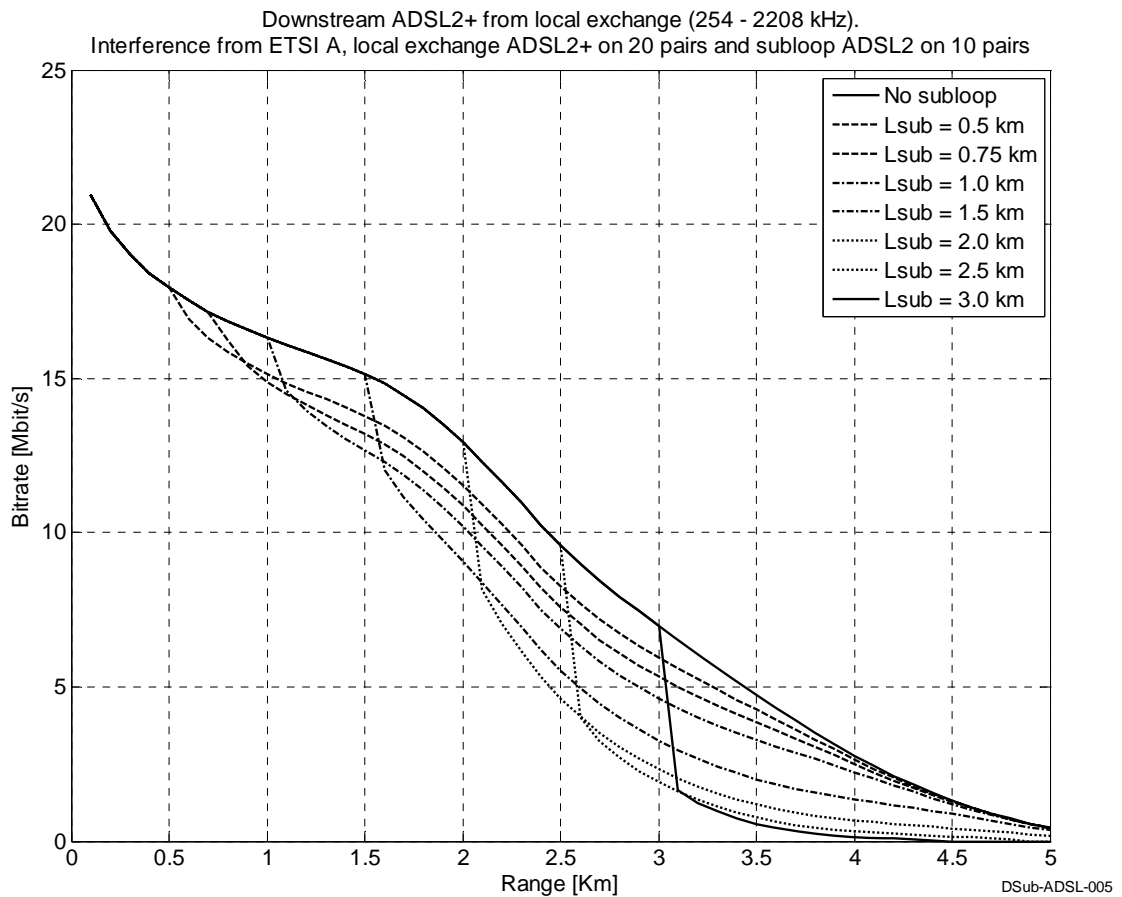
This section shows the potential bitrate of downstream ADSL2+ that is disturbed by ADSL subloop or ADSL2+ subloop without power backoff. Figure 7.8 to Figure 7.14 show the results for ADSL subloop, and Figure 7.16 to Figure 7.22 show the results for ADSL2+ subloop. The results are almost the same as for ADSL in Section 7.1, and the consequences are the same.

### 7.2.1 Downstream ADSL2+ with Interference from subloop ADSL on 10 pairs

ADSL2+ downstream from local exchange.  
 Interference from subloop ADSL2 on 10 pairs  
 Background noise: Local exchange ADSL2+ on 20 pairs and ETSI A  
 $L_{sub} = 0.5, 0.75, 1.0, 1.5, 2.0, 2.5$  and  $3.0$  km



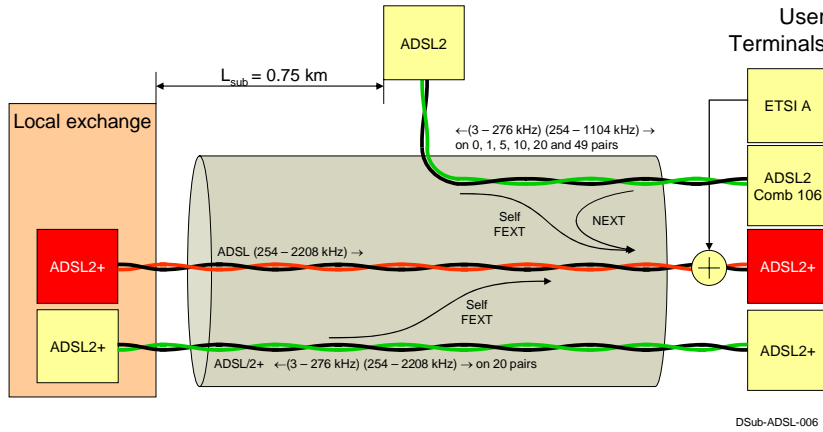
**Figure 7.7 Downstream ADSL2+. Interference from subloop ADSL, varying subloop length.**



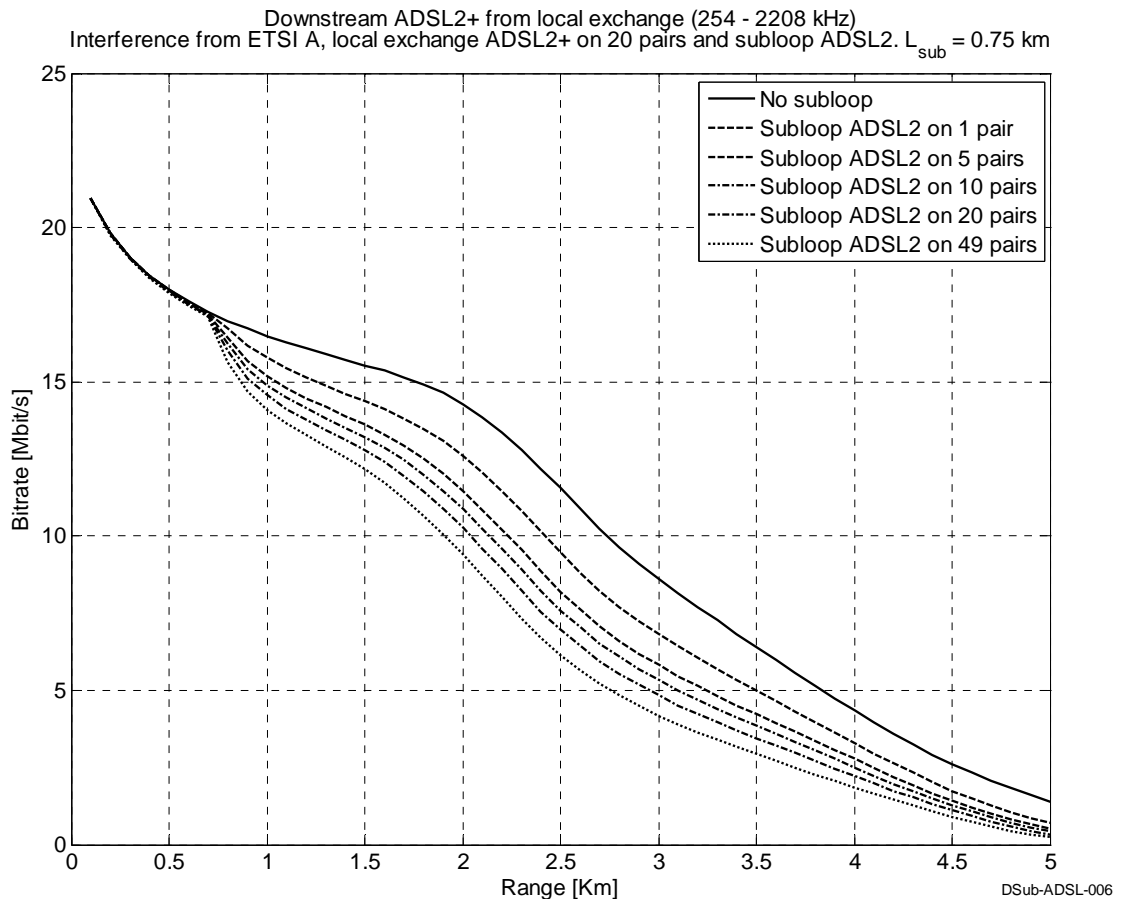
**Figure 7.8 Downstream ADSL2+. Interference from ADSL, varying subloop length.**

**7.2.2 Downstream ADSL2+ with interference from subloop ADSL on varying number of pairs.  $L_{sub} = 0.75$  km**

ADSL2+ downstream from local exchange.  
 Interference from subloop ADSL2 on 0, 1, 5, 10, 20, and 49 pairs  
 Background noise: Local exchange ADSL2+ on 20 pairs + ETSI A  
 $L_{sub} = 0.75$  km



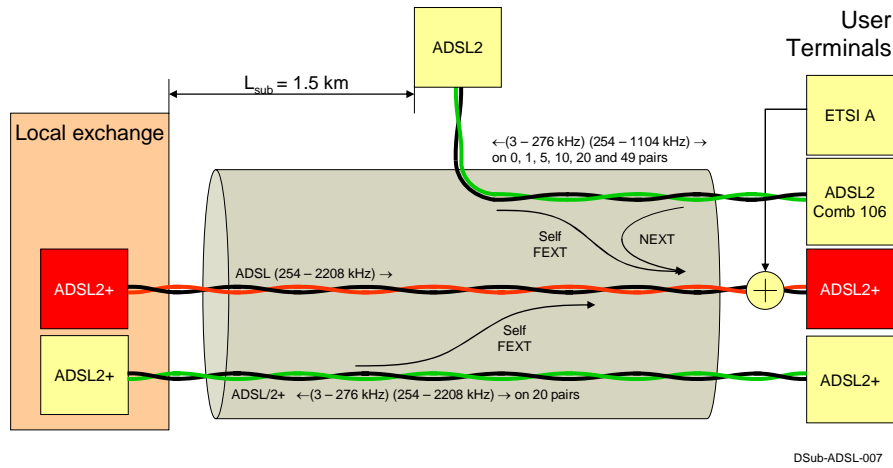
**Figure 7.9 Downstream ADSL2+. Interference from ADSL.  $L_{sub} = 0.75$  km, varying number of disturbers.**



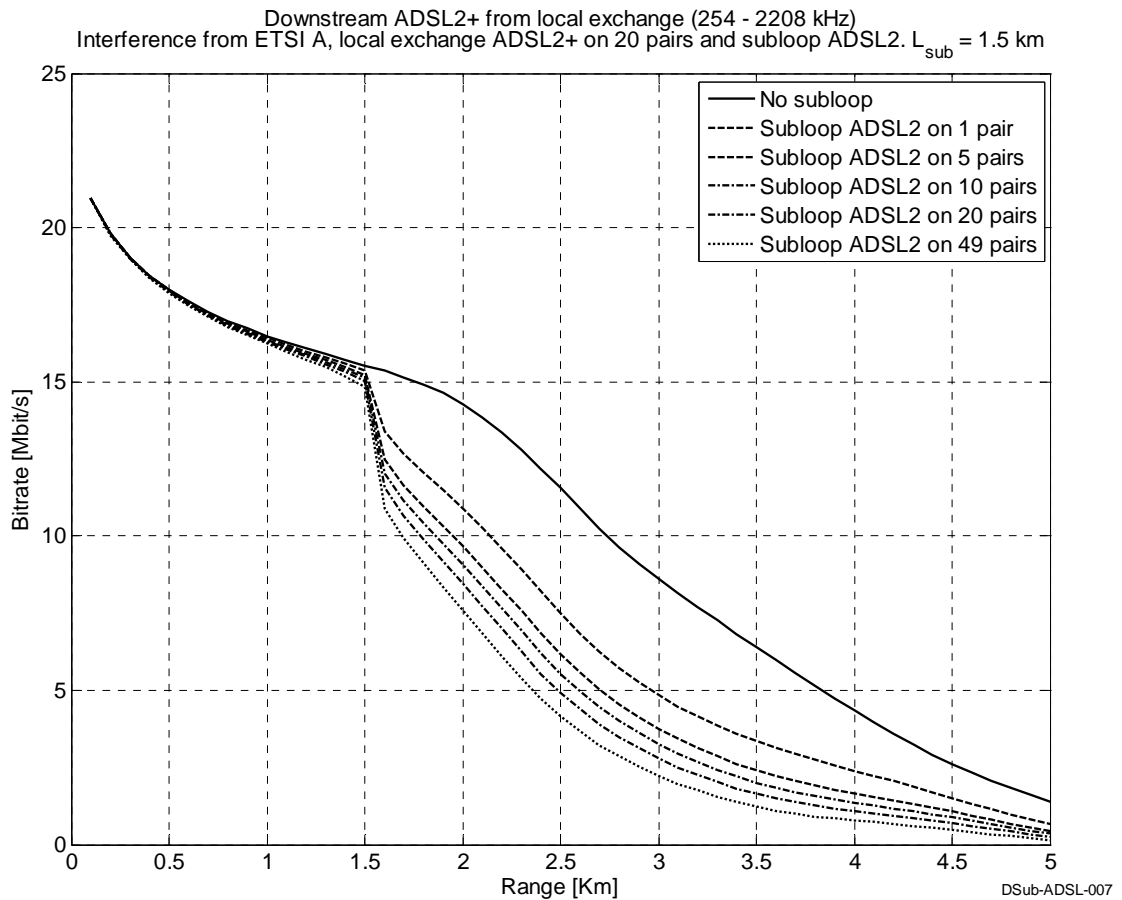
**Figure 7.10 Downstream ADSL2+. Interference from ADSL.  $L_{sub} = 0.75$  km, varying number of disturbers.**

**7.2.3 Downstream ADSL2+ with interference from subloop ADSL on varying number of pairs.  $L_{sub} = 1.5$  km**

ADSL2+ downstream from local exchange.  
 Interference from subloop ADSL on 0, 1, 5, 10, 20, and 49 pairs  
 Background noise: Local exchange ADSL2+ on 20 pairs + ETSI A  
 $L_{sub} = 1.5$  km



**Figure 7.11 Downstream ADSL2+. Interference from ADSL.  $L_{sub} = 1.5$  km, varying number of disturbers.**



**Figure 7.12 Downstream ADSL2+. Interference from ADSL.  $L_{sub} = 1.5$  km, varying number of disturbers.**

**7.2.4 Downstream ADSL2+ with interference from subloop ADSL on varying number of pairs.  $L_{sub} = 2.5$  km**

ADSL2+ downstream from local exchange.

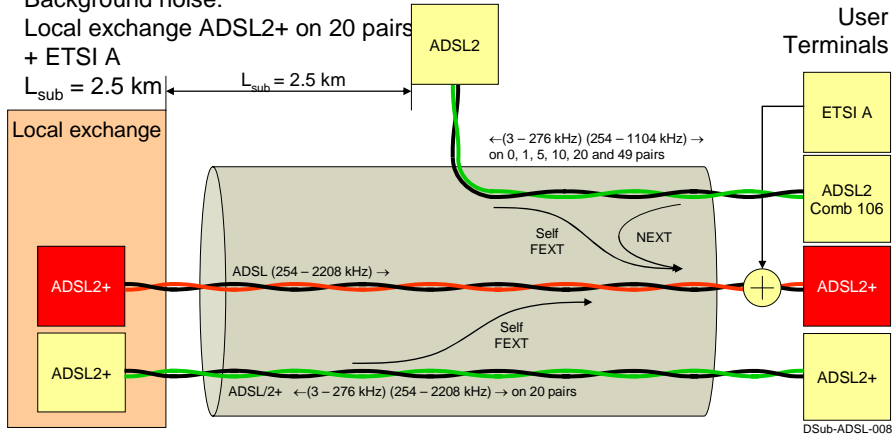
Interference from subloop ADSL2 on 0, 1, 5, 10, 20, and 49 pairs

Background noise:

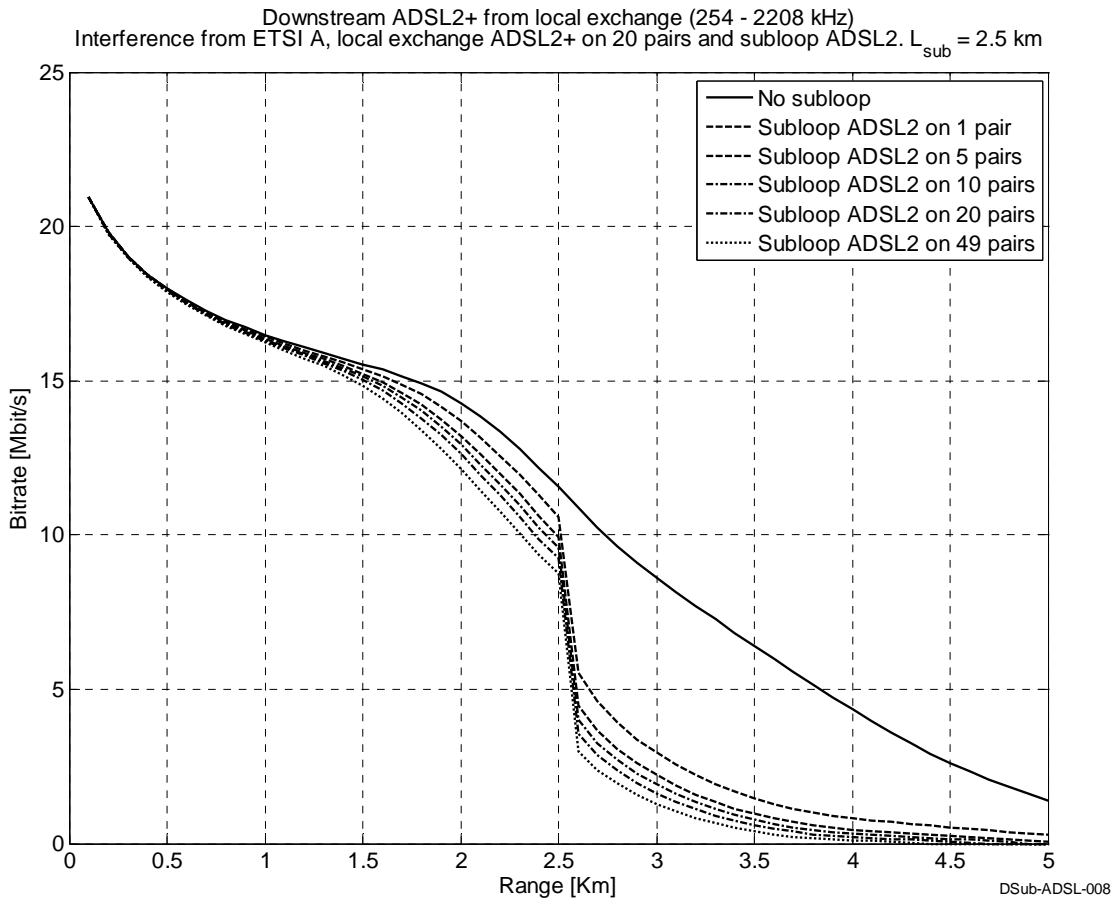
Local exchange ADSL2+ on 20 pairs

+ ETSI A

$L_{sub} = 2.5$  km



**Figure 7.13 Downstream ADSL2+. Interference from ADSL.  $L_{sub} = 2.5$  km, varying number of disturbers.**

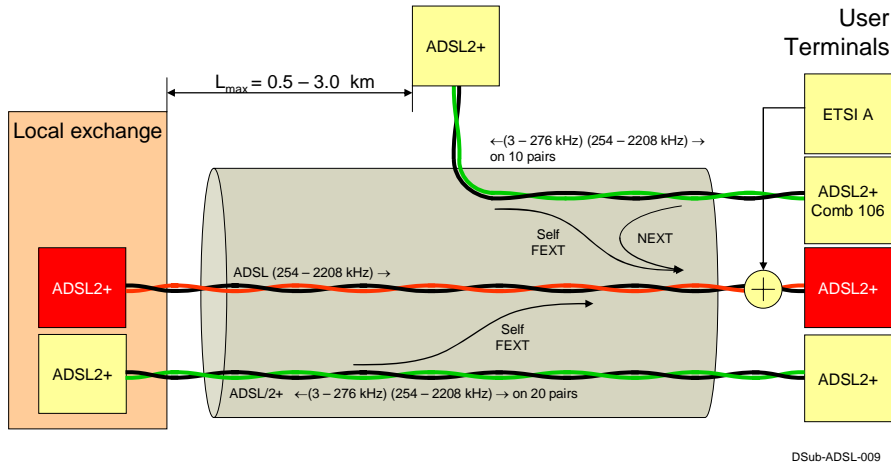


**Figure 7.14 Downstream ADSL2+. Interference from ADSL.  $L_{sub} = 2.5$  km, varying number of disturbers.**



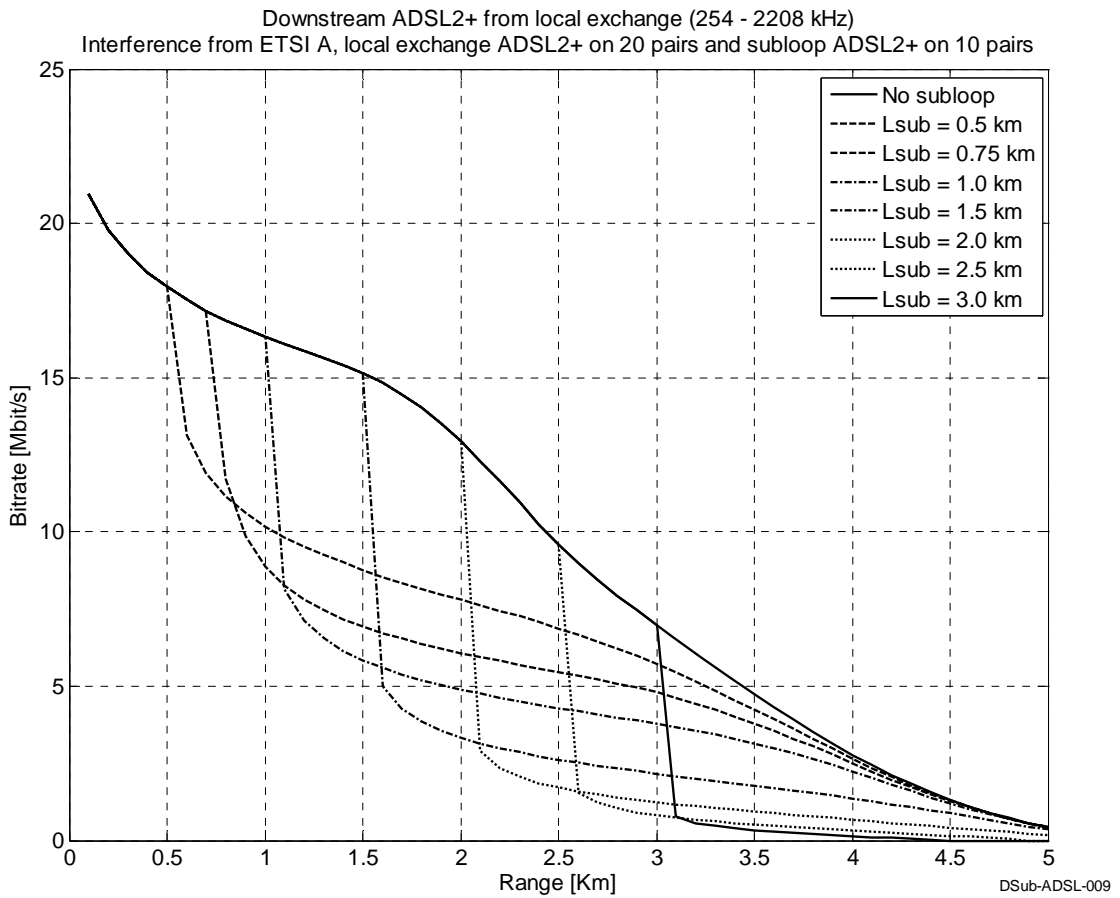
**7.2.5 Downstream ADSL2+ with interference from subloop ADSL2+ on 10 pairs, variable  $L_{sub}$**

ADSL2+ downstream from local exchange.  
 Interference from subloop ADSL2+ on 10 pairs  
 Background noise: Local exchange ADSL2+ on 20 pairs + ETSI A  
 $L_{sub} = 0.5, 0.75, 1.0, 1.5, 2.0, 2.5$  and  $3.0$  km



DSUB-ADSL-009

**Figure 7.15 Downstream ADSL2+. Interference from subloop ADSL2+, varying subloop length.**

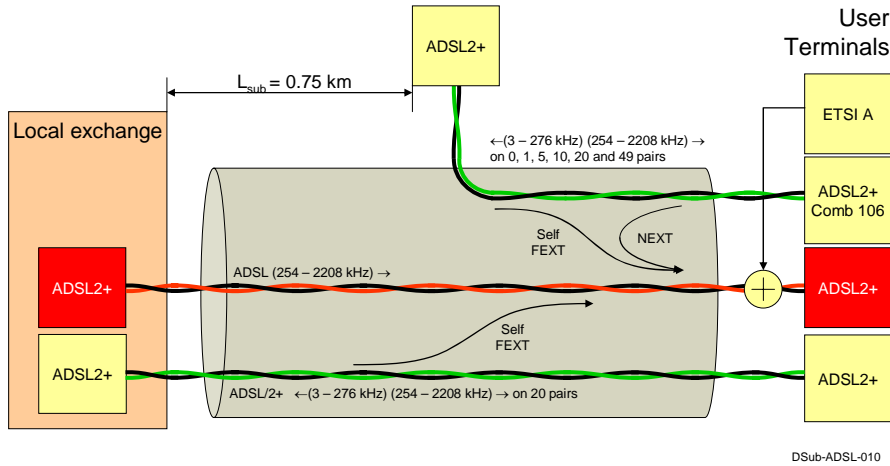


DSUB-ADSL-009

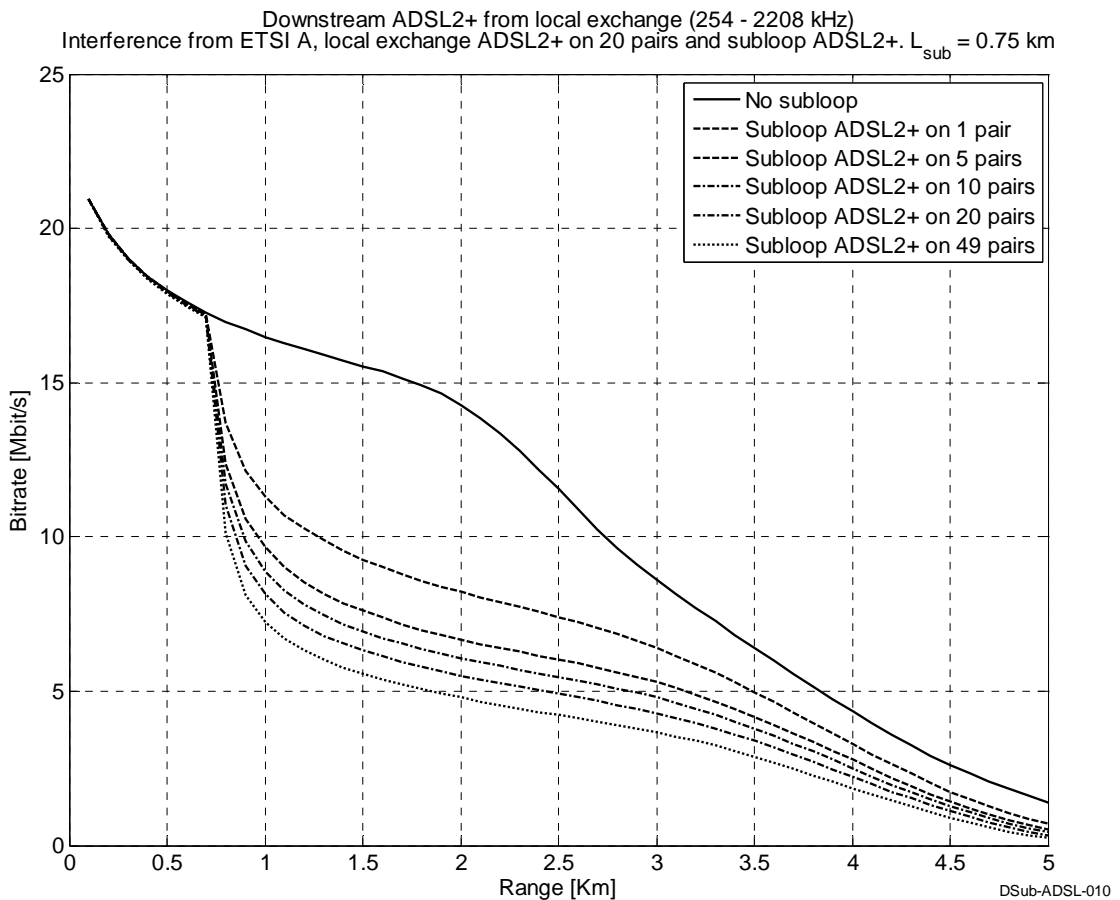
**Figure 7.16 Downstream ADSL2+. Interference from subloop ADSL2+, varying subloop length.**

**7.2.6 Downstream ADSL2+ with interference from subloop ADSL2+ on varying number of pairs.  $L_{sub} = 0.75$  km**

ADSL2+ downstream from local exchange.  
 Interference from subloop ADSL2+ on 0, 1, 5, 10, 20, and 49 pairs  
 Background noise: Local exchange ADSL2+ on 20 pairs + ETSI A  
 $L_{sub} = 0.75$  km



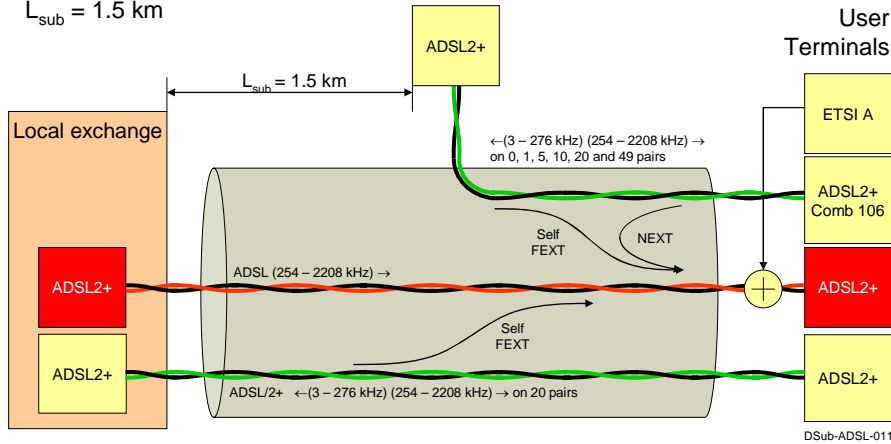
**Figure 7.17 Downstream ADSL2+. Interference from subloop ADSL2+,  $L_{sub} = 0.75$  km, varying number of disturbers.**



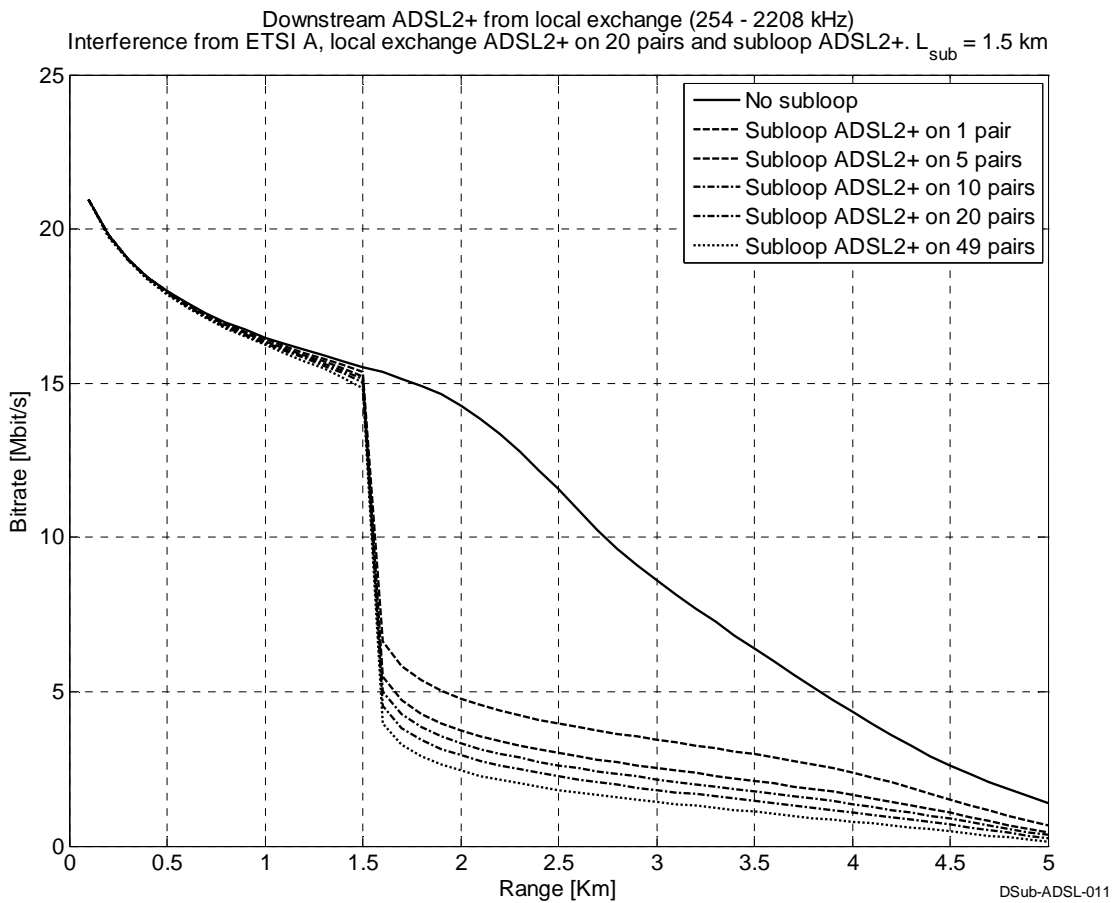
**Figure 7.18 Downstream ADSL2+. Interference from subloop ADSL2+,  $L_{sub} = 0.75$  km, varying number of disturbers.**

**7.2.7 Downstream ADSL2+ with interference from subloop ADSL2+ on varying number of pairs,  $L_{sub} = 1.5$  km**

ADSL2+ downstream from local exchange.  
 Interference from subloop ADSL2+ on 0, 1, 5, 10, 20, and 49 pairs  
 Background noise: Local exchange ADSL2+ on 20 pairs + ETSI A  
 $L_{sub} = 1.5$  km



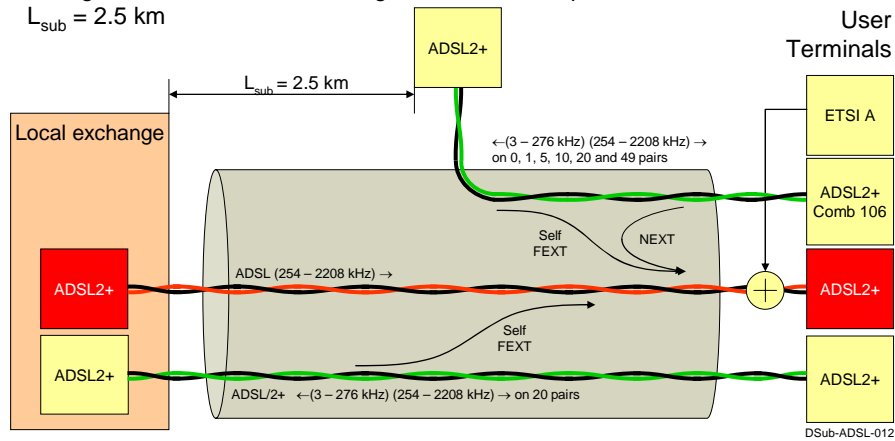
**Figure 7.19 Downstream ADSL2+. Interference from subloop ADSL2+,  $L_{sub} = 1.5$  km, varying number of disturbers.**



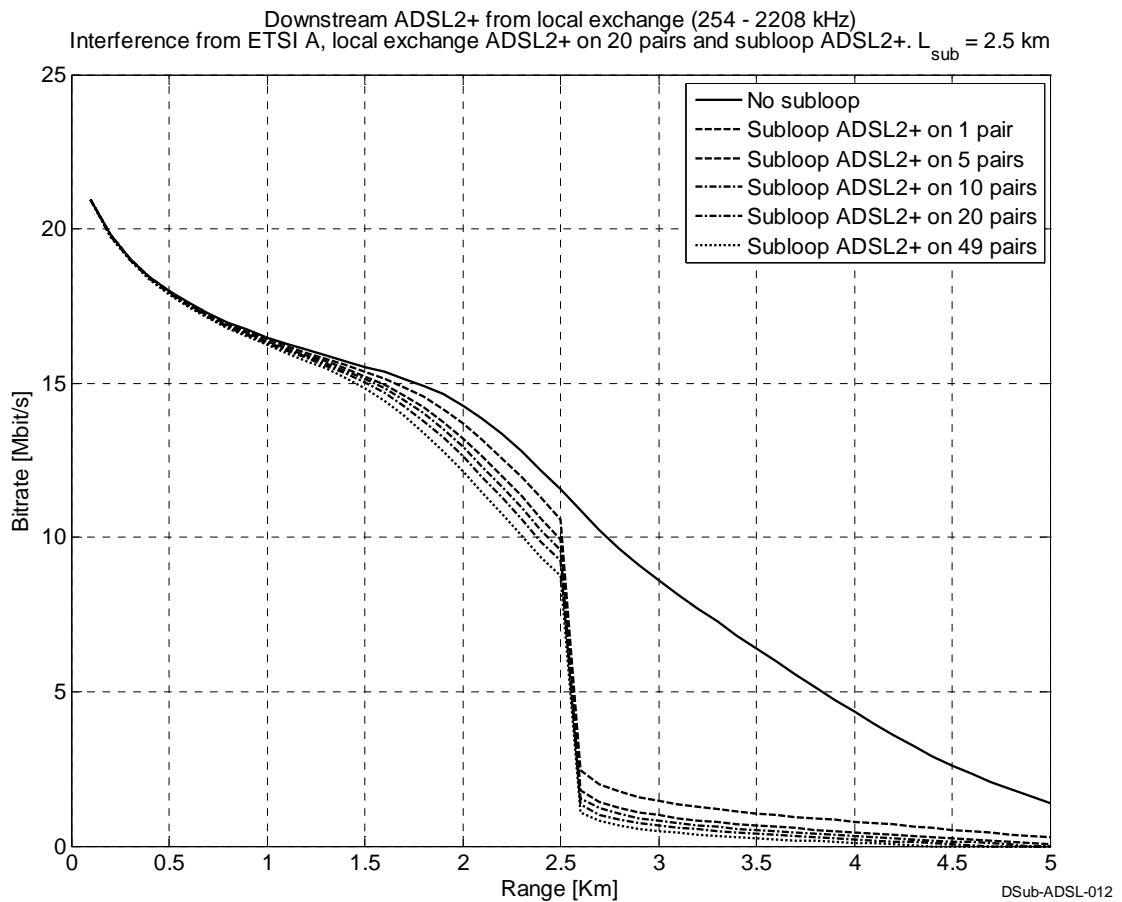
**Figure 7.20 Downstream ADSL2+. Interference from subloop ADSL2+,  $L_{sub} = 1.5$  km, varying number of disturbers.**

**7.2.8 Downstream ADSL2+ with interference from subloop ADSL2+ on varying number of pairs,  $L_{sub} = 2.5$  km**

ADSL2+ downstream from local exchange.  
 Interference from subloop ADSL2+ on 0, 1, 5, 10, 20, and 49 pairs  
 Background noise: Local exchange ADSL2+ on 20 pairs + ETSI A  
 $L_{sub} = 2.5$  km



**Figure 7.21 Downstream ADSL2+. Interference from subloop ADSL2+,  $L_{sub} = 2.5$  km, varying number of disturbers.**



**Figure 7.22 Downstream ADSL2+. Interference from subloop ADSL2+,  $L_{sub} = 2.5$  km, varying number of disturbers.**

## 8 Simulation results for VDSL2

Only the VDSL2 version of VDSL systems has been considered in this report. Six different cases have been analysed:

- VDSL2 using bandplan 997, B7-5. 25 kHz - 12.000 MHz
- VDSL2 using bandplan 997, B7-9. 25 kHz – 12.000 MHz
- VDSL2 using bandplan 997, B7-10. 25 kHz to 30.000 MHz
- VDSL2 using bandplan 998, B8-7. 138 kHz to 12.000 MHz
- VDSL2 using bandplan 998, B8-8. 138 kHz to 17.664 MHz
- VDSL2 using bandplan 998, B8-13. 276 kHz to 30.000 MHz

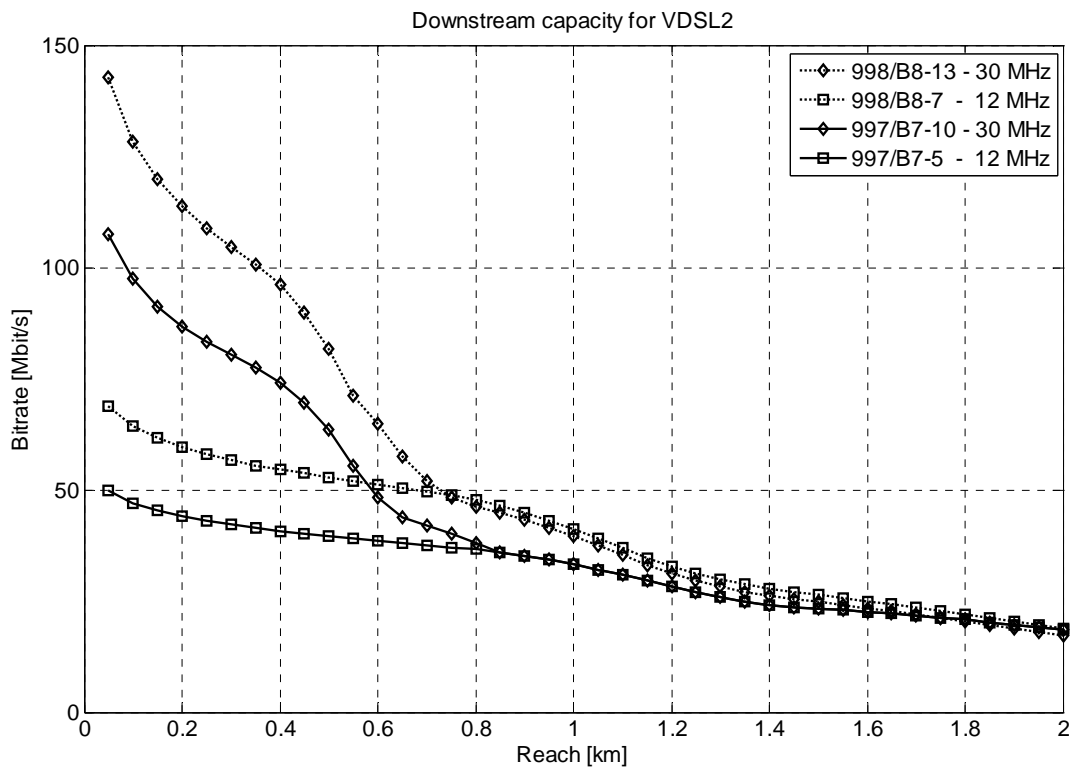
The major difference between bandplan 997 and 998 is the allocation of up- and downstream bandwidths.

Bandplan 997 is close to symmetric with respect to up- and downstream bitrate for cable lengths shorter than 0.8 km. At larger distances the asymmetry in bitrate is in favour of the downstream direction. At lengths above 800 meters the bitrate of all three 997 schemes (12, 17 and 30 MHz bandwidth) are the same. This means that capacity is only allocated to frequencies below 12 MHz at cable lengths above 1 km. The downstream bitrate is significant even at 2 km length (18.6 Mbit/s). The upstream bitrate for 997 at 2 km is 1.2 Mbit/s, which is only a fraction of the bitrate at shorter lengths, but still enough for simple services. The upstream bitrate is maintained at this level due to the lowest upstream band, U0 (25 kHz – 138 kHz.)

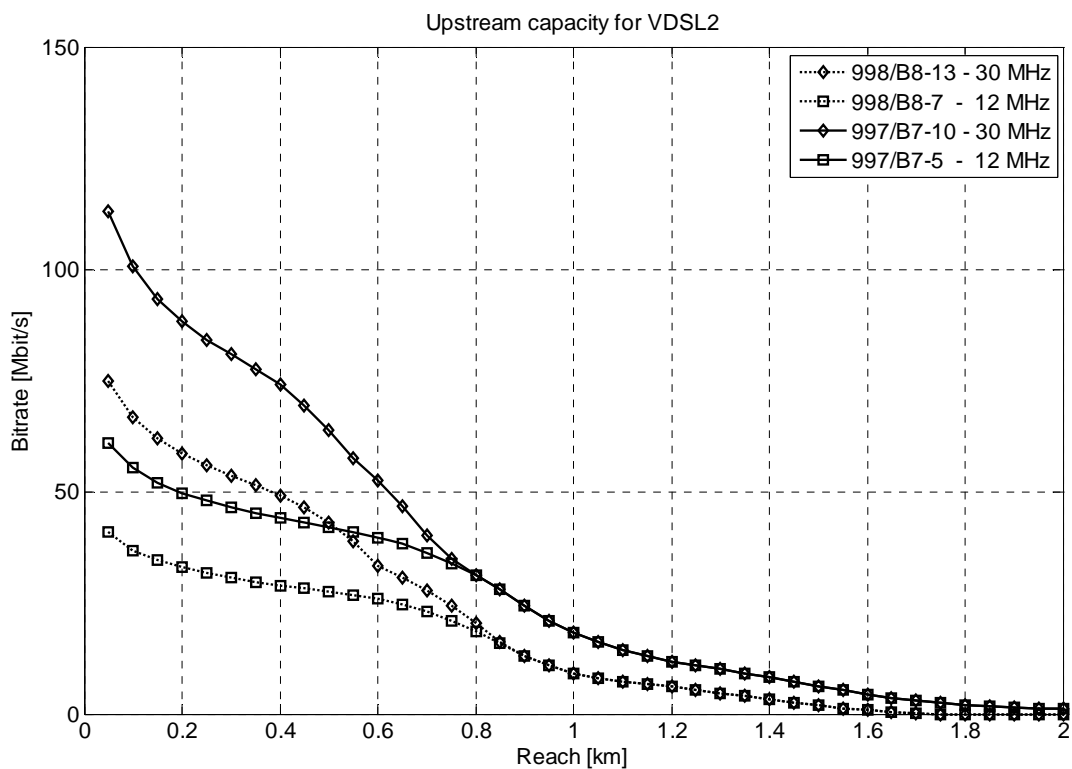
Bandplan 998 is asymmetric in favour of the downstream capacity for all cable lengths. For cables up to 800 meters the ratio of downstream/upstream bitrate is close to 2:1. For longer cables the downstream bitrate converges towards the same values as for bandplan 997. The upstream bitrate, however, is zero for cables longer than 1.8 km. This is due to the fact that there is no upstream band below 276 kHz (U0). Bandplan 998 without a U0 upstream band can therefore not be used at cable lengths above approximately 1.5 km. The bitrate for cable lengths longer than 800 meters is the same for all three 998 schemes (12, 17 and 30 MHz bandwidth).

**Table 8.1 Up- and downstream bitrates [Mbit/s] for VDSL2 bandplan 997 and 998 with 5 disturbing VDSL2 systems.**

Freq plan		Freq. range	Direction	Length [km]								
				0.3	0.4	0.5	0.6	0.8	1.0	1.25	1.5	2.0
Bandplan 997	B7-5	25 kHz to 12 MHz	Up	46.4	44.0	41.9	39.7	31.1	18.3	11.0	6.3	1.2
			Down	42.2	40.7	39.6	38.6	36.6	33.2	27.0	23.3	18.6
	B7-9	25 kHz to 17.66 MHz	Up	63.3	59.5	55.6	49.5	31.1	18.3	11.0	6.3	1.2
			Down	53.6	50.1	48.0	45.6	38.1	33.2	27.0	23.3	18.6
	B7-10	25 kHz to 30 MHz	Up	80.8	74.0	63.8	52.5	31.1	18.3	11.0	6.3	1.2
			Down	80.3	74.1	63.5	48.2	38.1	33.2	27.0	23.3	18.6
Bandplan 998	B8-7	138 kHz to 12 MHz	Up	30.6	28.9	27.5	25.8	18.6	9.1	5.4	1.9	0.0
			Down	56.7	54.5	52.8	51.3	47.8	41.1	31.1	26.4	18.9
	B8-8	138 kHz to 17.66 MHz	Up	40.7	38.3	36.0	33.0	20.4	9.1	5.4	1.9	0.0
			Down	73.6	70.1	66.5	61.1	47.8	41.1	31.1	26.4	18.9
	B8-12	276 kHz to 30 MHz	Up	53.5	49.2	42.9	33.4	20.4	9.1	5.4	1.9	0.0
			Down	105	96.1	81.7	64.8	46.2	39.5	29.5	24.8	17.3

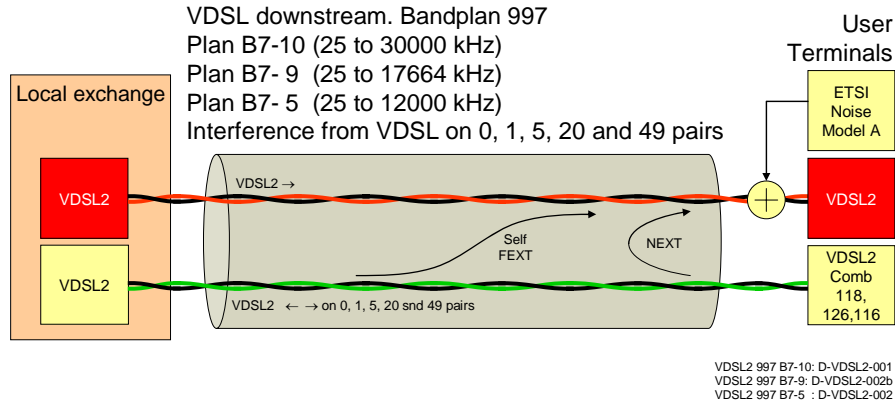


**Figure 8.1** Downstream bitrate for VDSL2, bandplan 997 and 998. Interference from ETSI A noise and five VDSL2 systems.



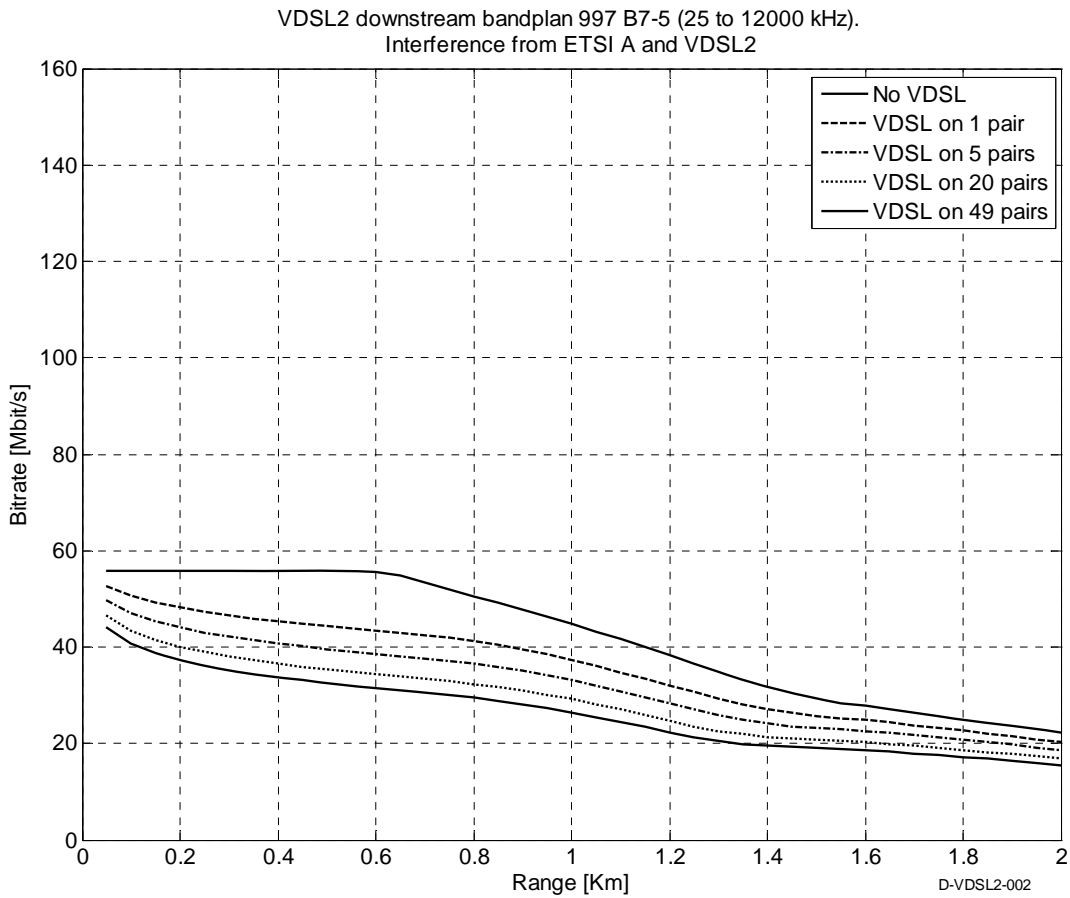
**Figure 8.2** Upstream bitrate for VDSL2, bandplan 997 and 998. Interference from ETSI A noise and five VDSL2 systems.

**8.1 Downstream VDSL2 bandplan 997**



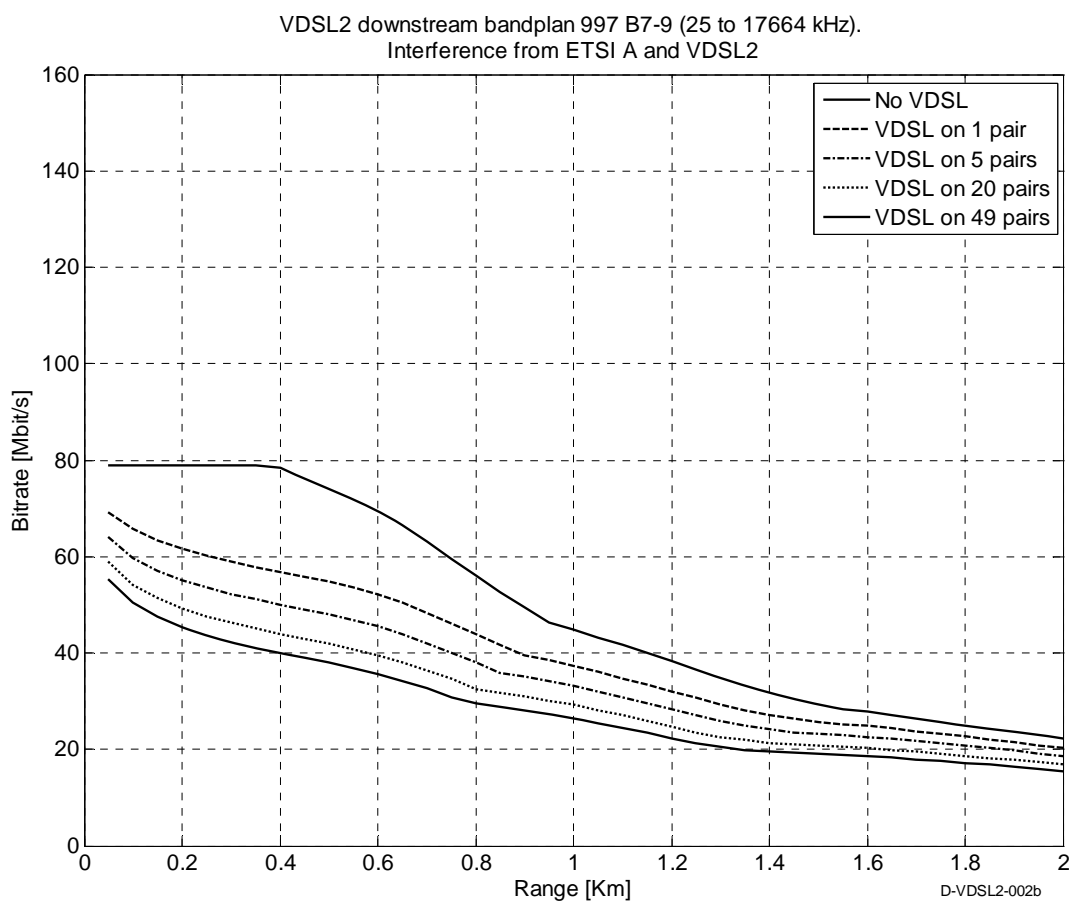
**Figure 8.3 Downstream VDSL2 bandplan 997. Interference from VDSL2, NEXT and FEXT.**

**8.1.1 Downstream VDSL2, bandplan 997, B7-5 (25 kHz - 12 MHz.)**



**Figure 8.4 Downstream bitrate for VDSL2, bandplan 997/B7-5 (25 kHz – 12 MHz).**

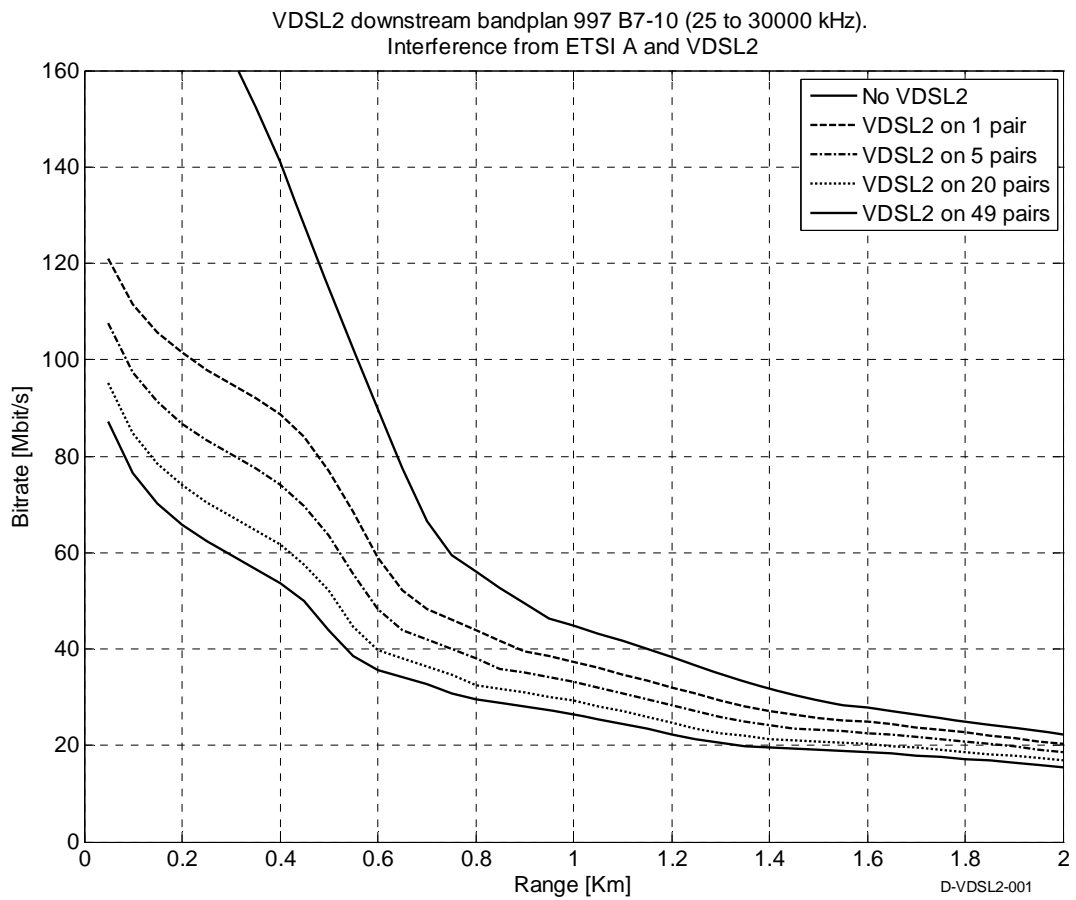
### 8.1.2 Downstream VDSL2, bandplan 997 B7-9 (25 kHz - 17.664 MHz.)



**Figure 8.5** Downstream bitrate for VDSL2, bandplan 997/B7-9 (25 kHz – 17.664 MHz).

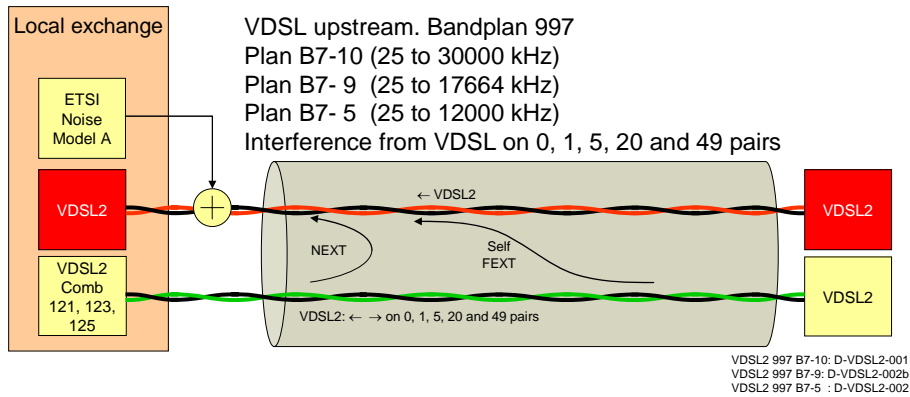


**8.1.3 Downstream VDSL2, bandplan 997 B7-10 (25 kHz – 30 MHz.)**



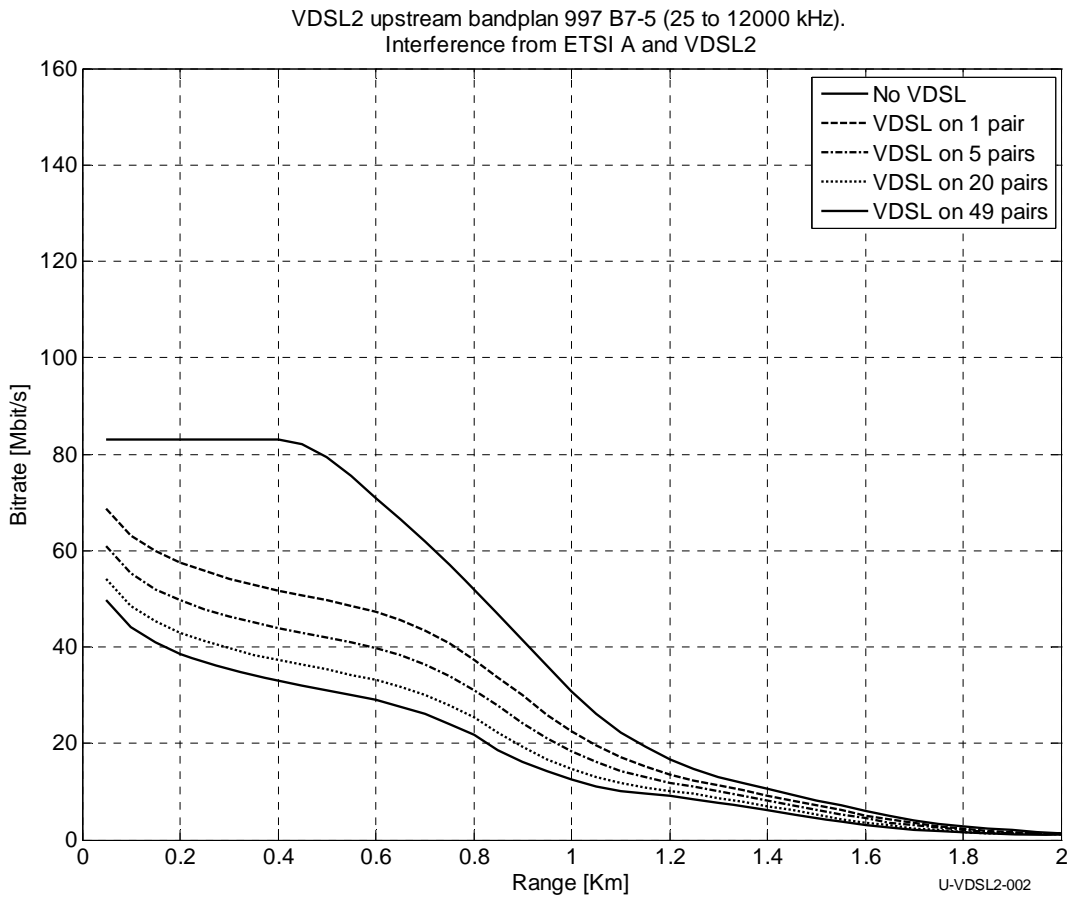
**Figure 8.6 Downstream bitrate for VDSL2, bandplan 997/B7-10 (25 kHz – 30 MHz).**

## 8.2 Upstream VDSL2, bandplan 997



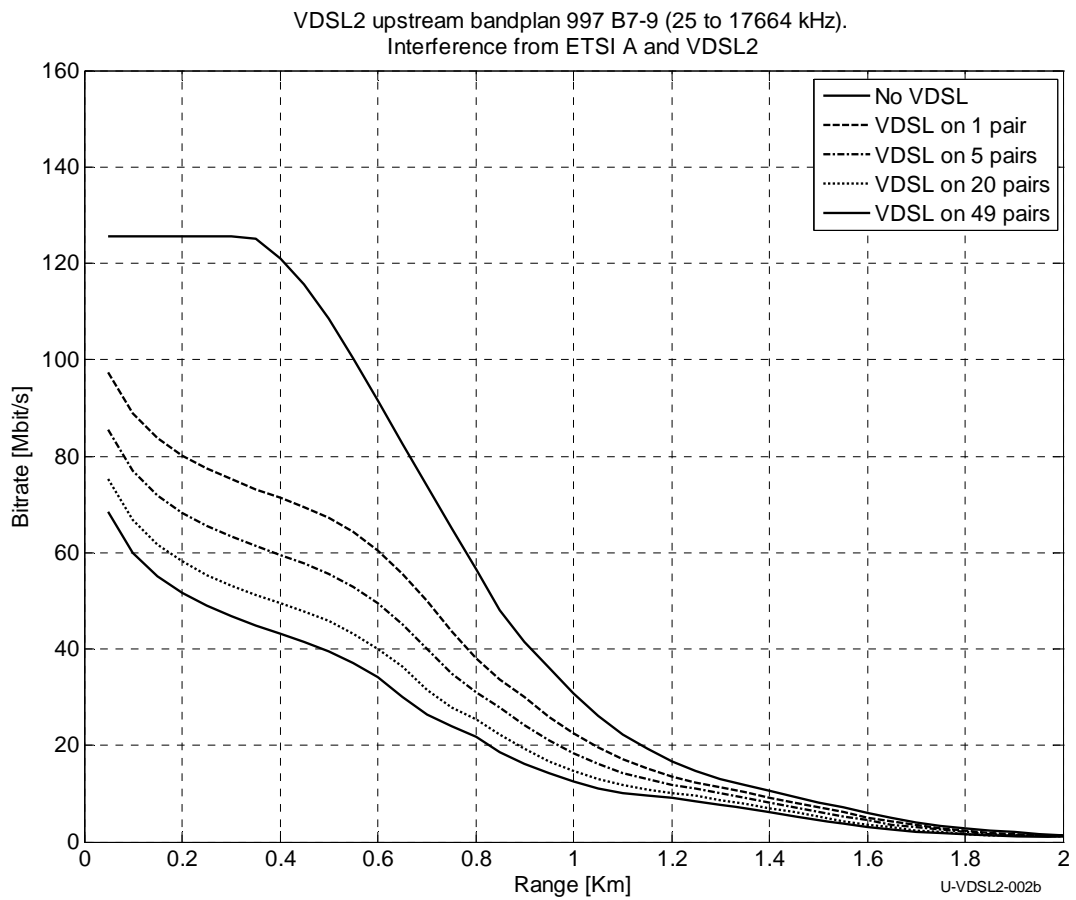
**Figure 8.7 Upstream VDSL2, bandplan 997. Interference from VDSL2, NEXT and FEXT.**

### 8.2.1 Upstream VDSL2, bandplan 997 B7-5 (25 kHz – 12 MHz)



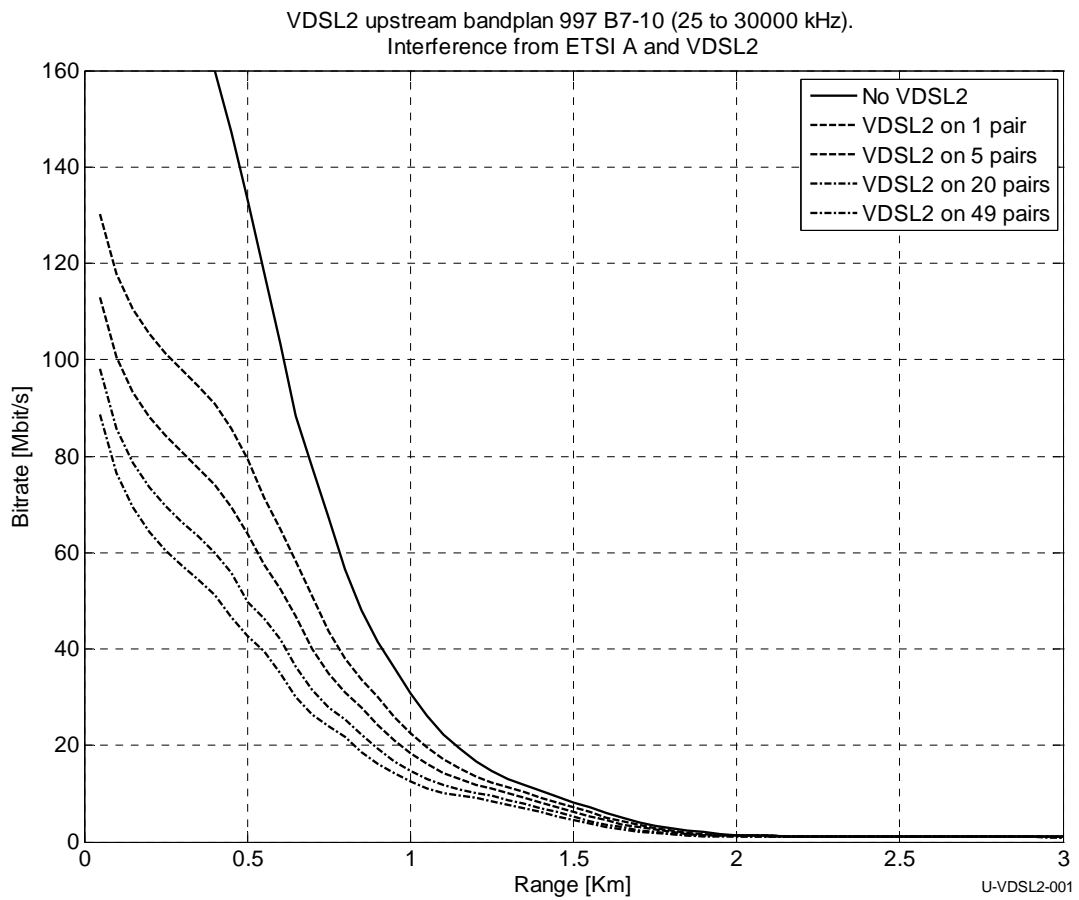
**Figure 8.8 Upstream bitrate for VDSL2, bandplan 997/B7-5 (25 kHz – 12 MHz).**

**8.2.2 Upstream VDSL2, bandplan 997 B7-9 (25 kHz – 17.664 MHz)**



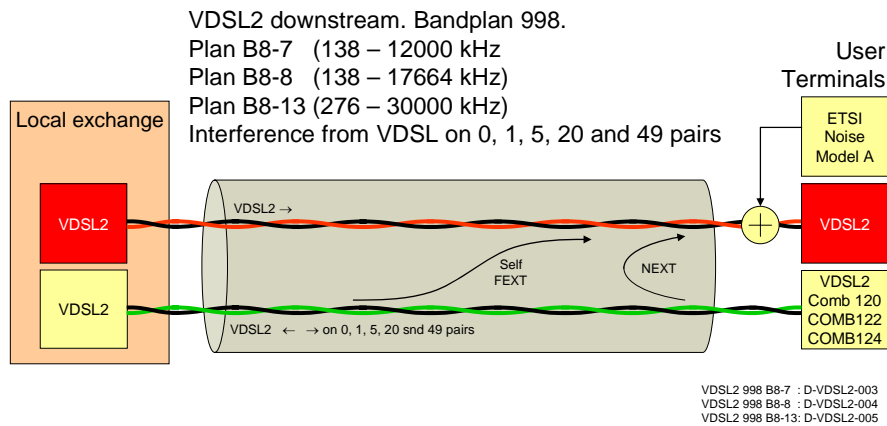
**Figure 8.9 Upstream bitrate for VDSL2, bandplan 997/B7-9 (25 kHz – 17.664 MHz).**

**8.2.3 Upstream VDSL2, bandplan 997 B7-10 (25 kHz - 30 MHz)**



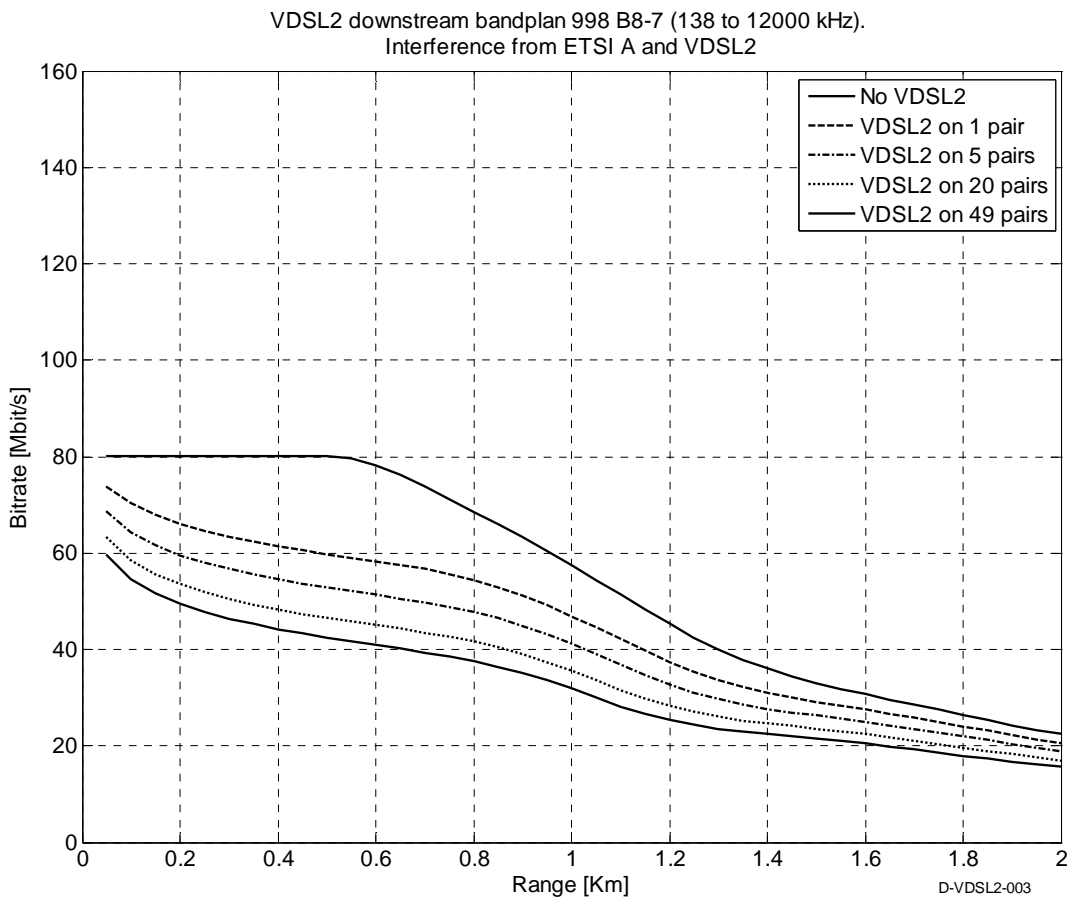
**Figure 8.10 Upstream bitrate for VDSL2, bandplan 997/B7-10 (25 kHz – 30 MHz).**

### 8.3 Downstream VDSL2, bandplan 998



**Figure 8.11 Downstream VDSL2, bandplan 998. Interference from VDSL2, NEXT and FEXT.**

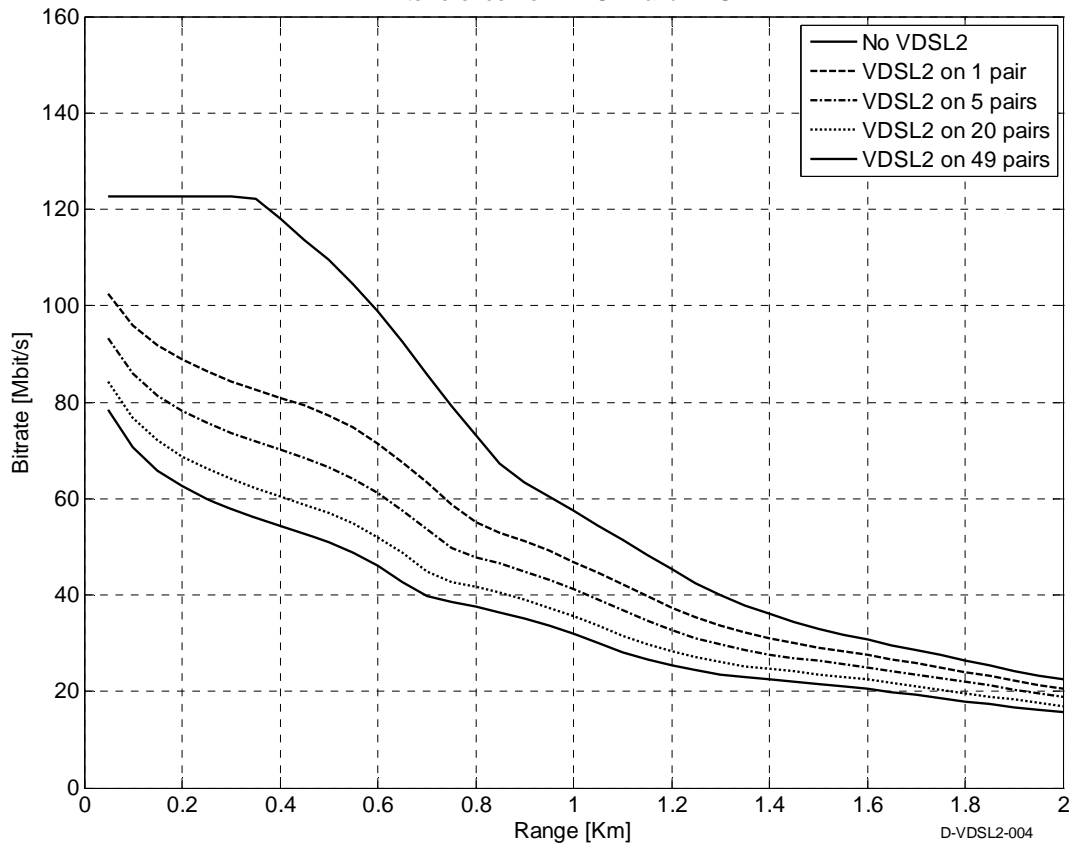
#### 8.3.1 Downstream VDSL2, bandplan 998 B8-7 (138 kHz – 12 MHz)



**Figure 8.12 Downstream bitrate for VDSL2, bandplan 998/B8-7 (138 kHz – 12 MHz).**

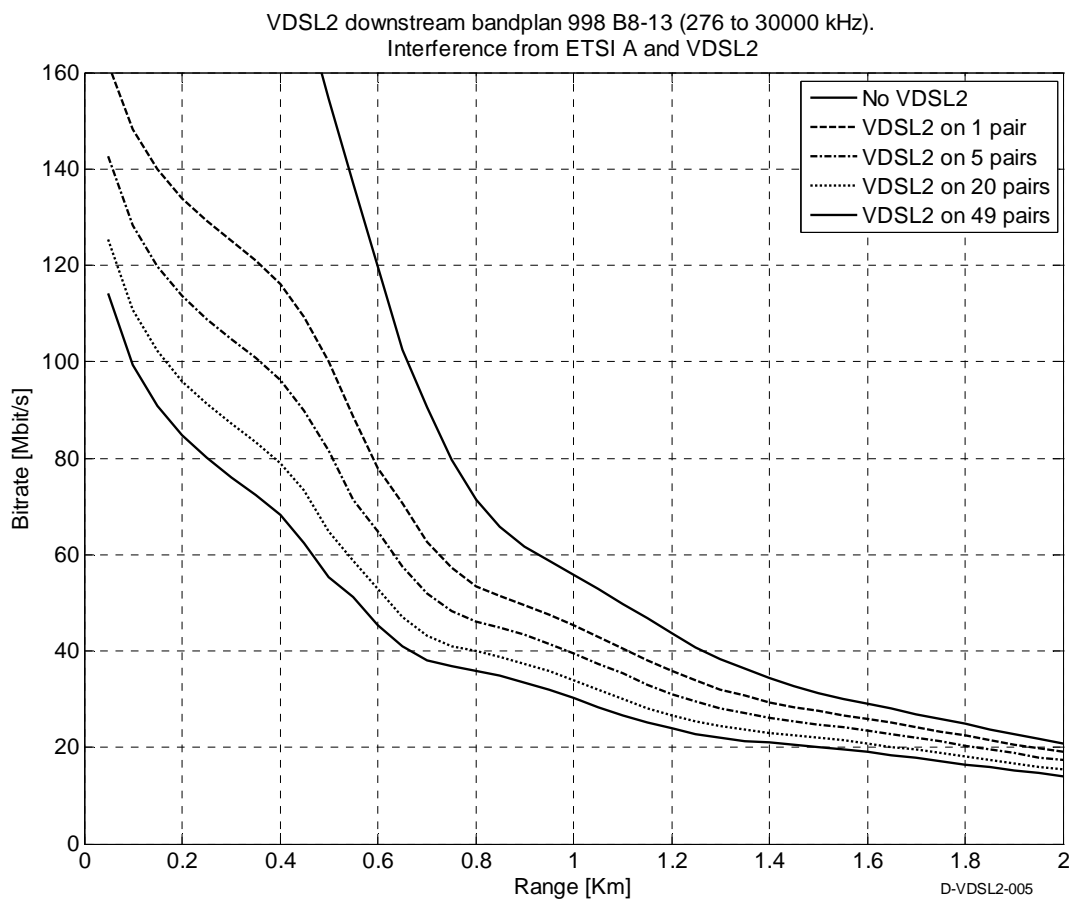
**8.3.2 Downstream VDSL2, bandplan 998 B8-8 (138 kHz – 17.664 MHz)**

VDSL2 downstream bandplan 998 B8-8 (138 to 17664 kHz).  
Interference from ETSI A and VDSL2



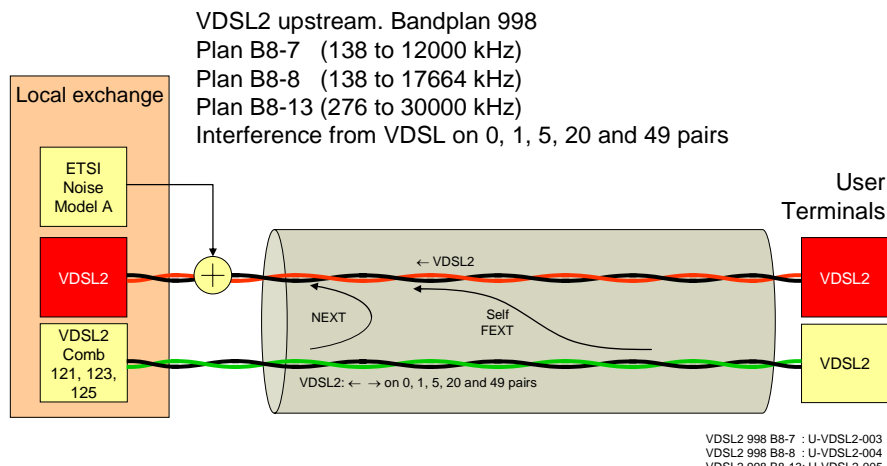
**Figure 8.13 Downstream bitrate for VDSL2, bandplan, 998/B8-8 (138 kHz – 17.664 MHz).**

### 8.3.3 Downstream VDSL2, bandplan 998 B8-13 (276 kHz – 30 MHz)



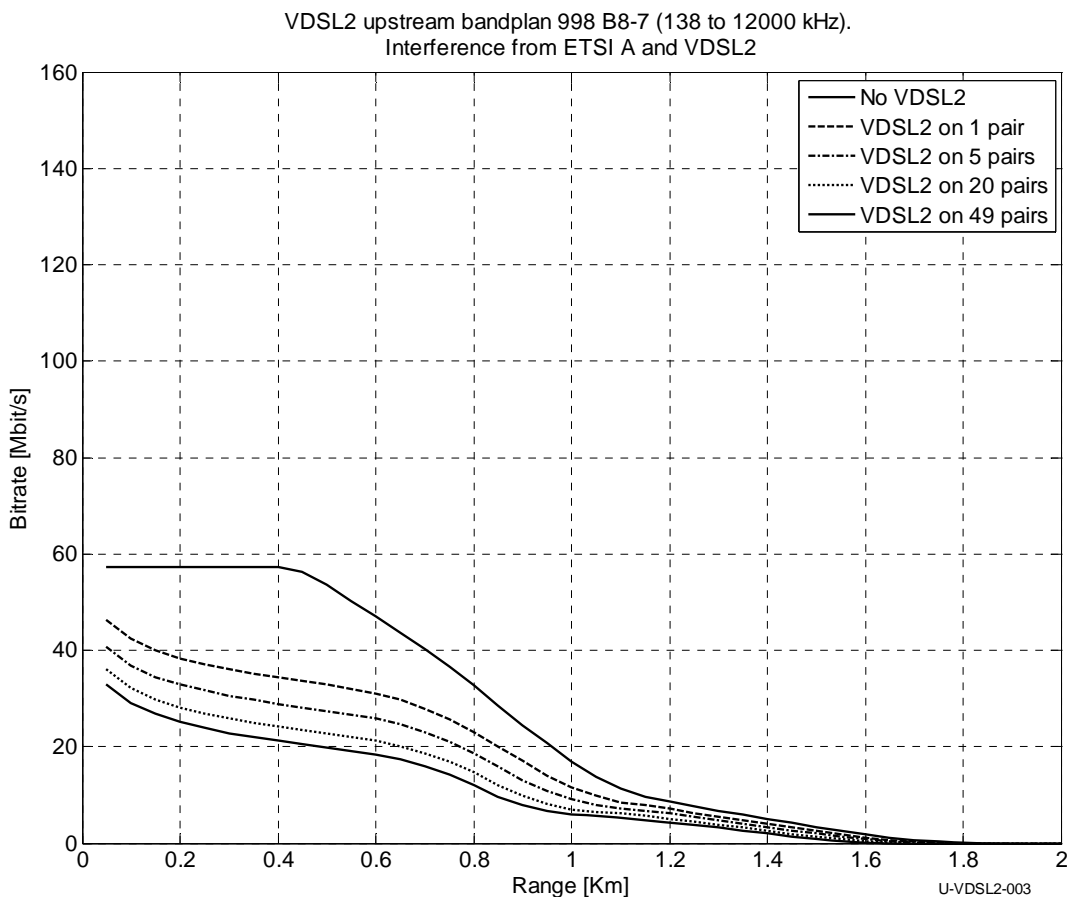
**Figure 8.14 Downstream bitrate for VDSL2, bandplan 998/B8-13 (276 kHz – 30 MHz).**

### 8.4 Upstream VDSL2, bandplan 998



**Figure 8.15 Upstream VDSL2, bandplan 998. Interference from VDSL2, NEXT and FEXT.**

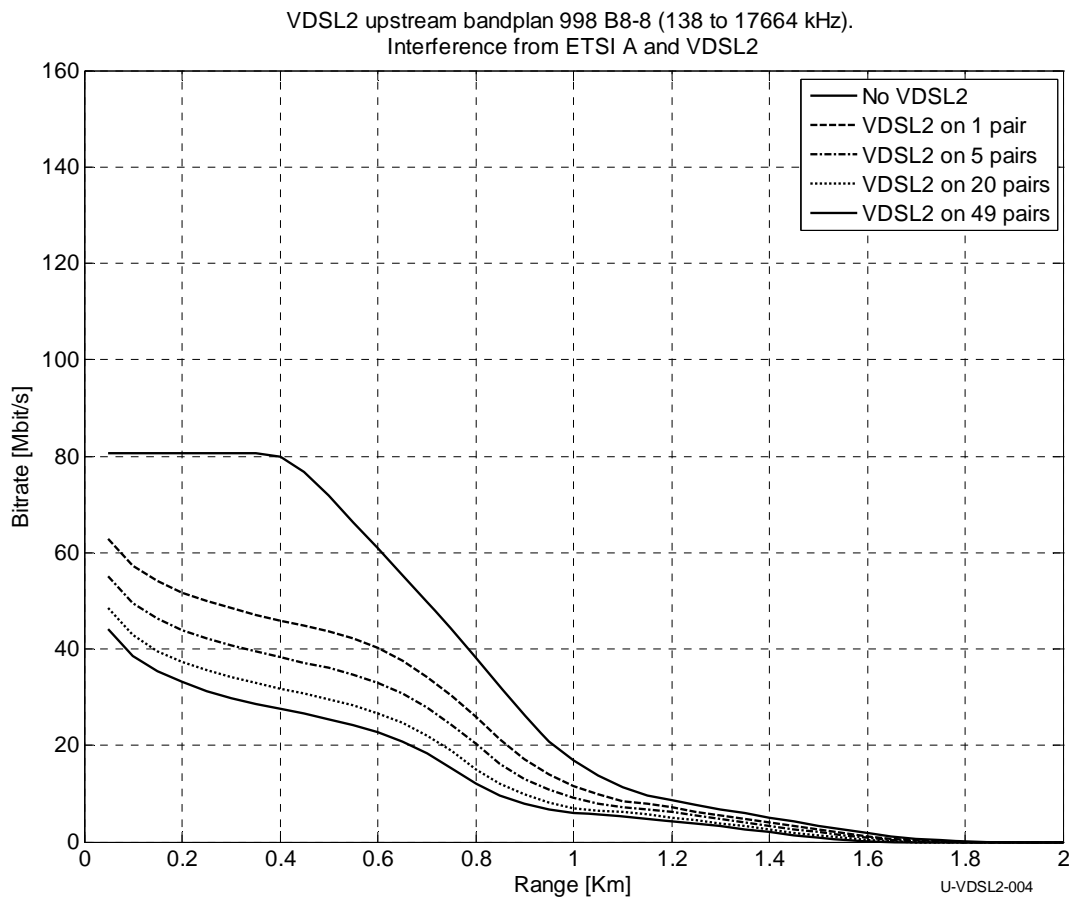
#### 8.4.1 Upstream VDSL2, bandplan B8-7 (138 kHz – 12 MHz)



**Figure 8.16 Upstream bitrate for VDSL2, bandplan, 998/B8-7 (138 kHz – 12 MHz).**

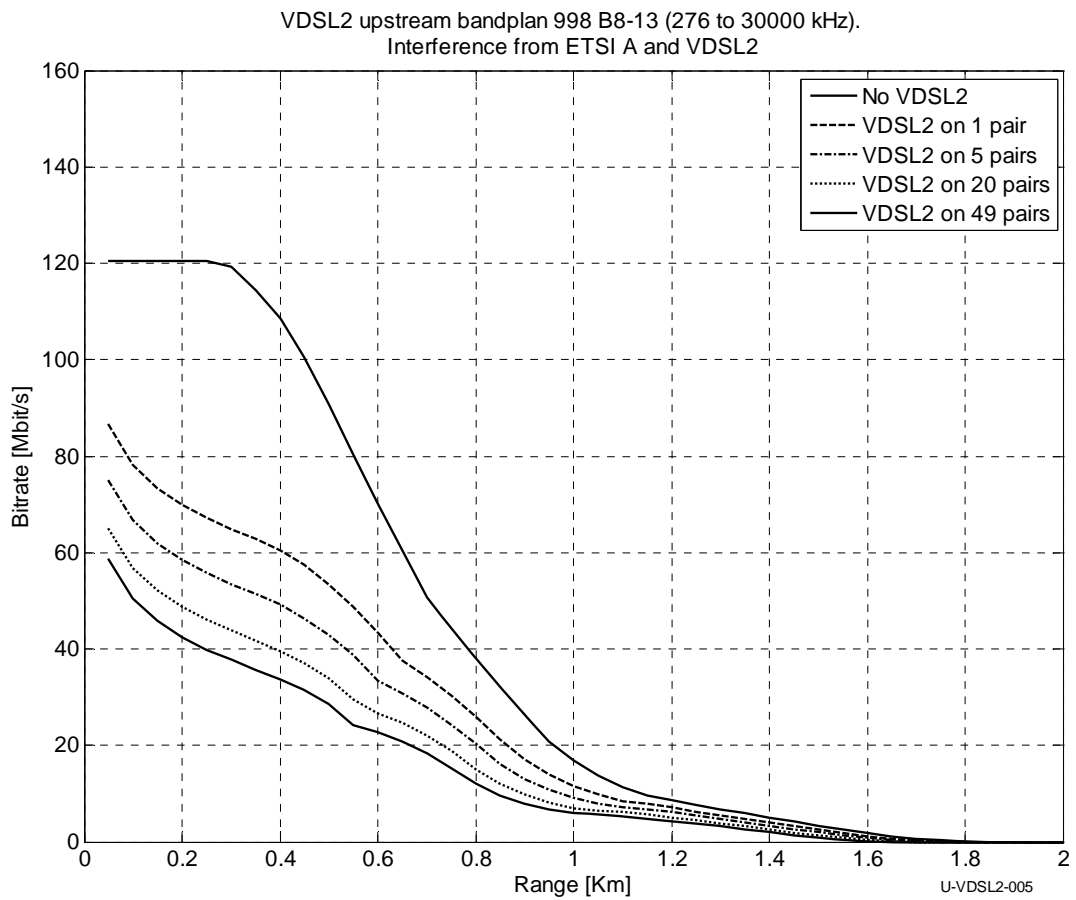


### 8.4.2 Upstream VDSL2, bandplan B8-8 (138 kHz – 17.664 MHz)



**Figure 8.17 Upstream bitrate for VDSL2, bandplan 998/B8-8 (138 kHz – 17.664 MHz).**

**8.4.3 Upstream VDSL2, bandplan B8-13 (276 kHz – 30 MHz)**



**Figure 8.18 Upstream bitrate for VDSL2, bandplan 998/B8-13 (276 kHz – 30 MHz).**

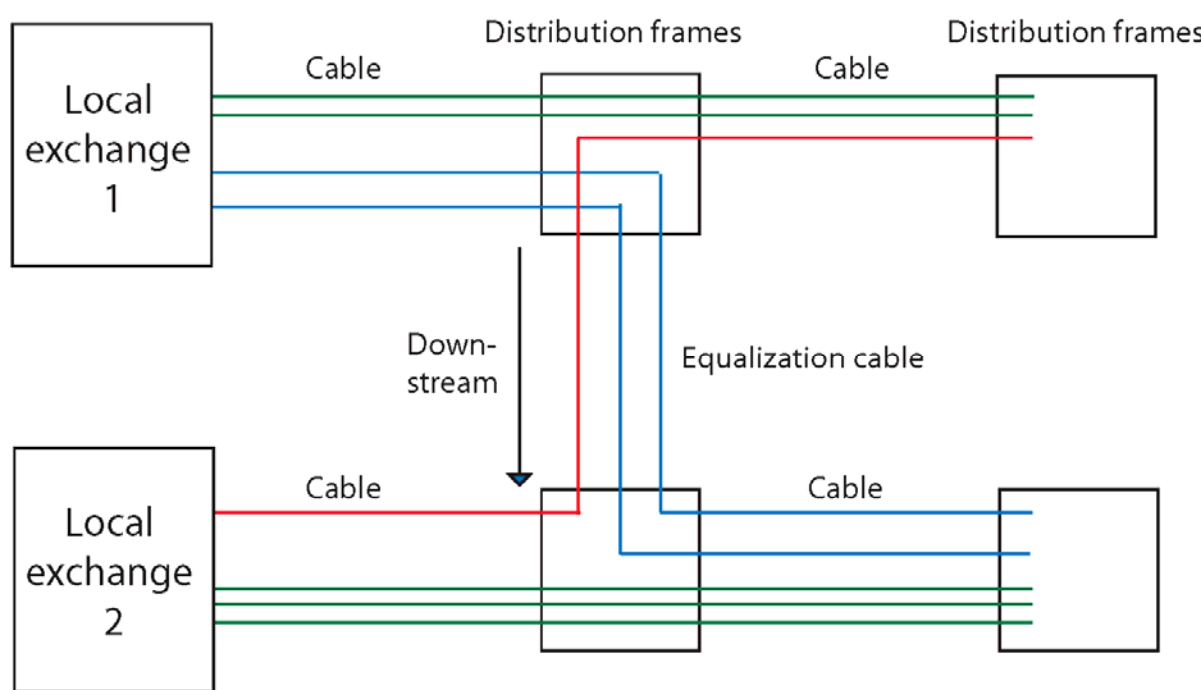
### 9 Use of ADSL in a network containing equalization cables

An equalization cable is a cable between two distributors that belong to different local exchanges. Equalization cables are usually installed for use in telephony services (POTS or ISDN) in order to solve bottleneck problems, like lack of available pairs in a cable or lack of lines in an exchange. This is illustrated in Figure 9.1. However, it is not straightforward to install ADSL in pairs that pass through an equalization cable for two main reasons:

- different signal levels in pairs from an equalization cable and other pairs
- conflicting directions of transmission within the equalization cable

A key element in the ADSL (and VDSL) standard is to divide the cable into upstream and downstream frequency bands. By using one-way transmission in each band, NEXT is eliminated, and the channel capacity is significantly increased. When equalization cables are used for DSL transmission, it will be necessary to define a downstream direction for the equalization cable. Hence, only ADSL transmission systems in accordance with the defined direction of transmission should be permitted.

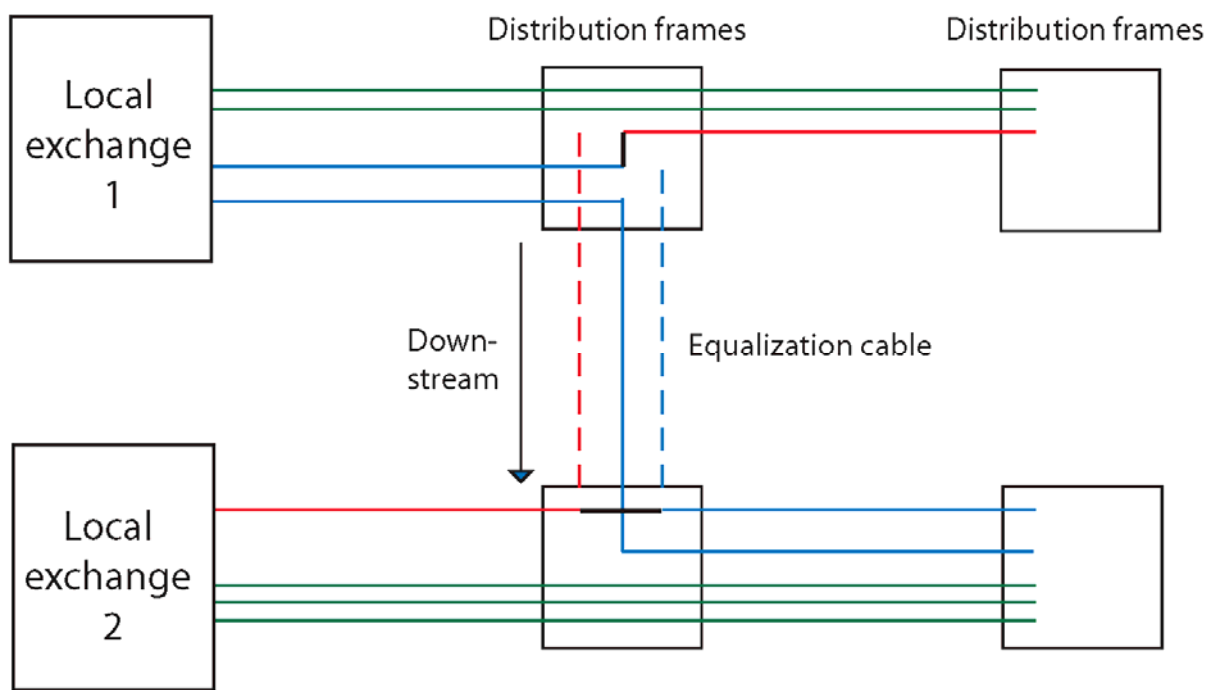
The length of the direct pairs from Local exchange 2 and the blue pairs from the equalization cable will usually have different lengths. Hence, installing ADSL in a pair that passes through an equalization cable will cause a situation that is similar to ADSL subloop. In order to install ADSL, there should not be too much difference in length between the direct (green) pairs from Local exchange 2 and the length of the blue pairs, measured up to the point where they meet. Normally, the direct pairs will be shorter. The main problem for this case will be reduced downstream bitrate in the pairs that pass through the equalization cable, and ADSL in the direct pairs will not be degraded. Before ADSL is installed in equalization cables, each situation should be analyzed, either by a calculation or by a set of rules. A quantitative analysis of this problem is beyond the scope of the current project.



**Figure 9.1 Equalization cable with conflicting directions of transmission.**

For historical reasons, both directions of transmission may be present in the same cable as shown in the example in Figure 9.1. For the defined direction of transmission, the red pair is in conflict

with the definition and cannot carry ADSL. This conflict can only be resolved by reconnecting pairs. A possible approach is illustrated in Figure 9.2 and is as follows. The downstream direction is defined as the direction where most of the pairs carry downstream signals. The pairs with the conflicting direction of transmission have to be disconnected from the equalization cable. The corresponding subscribers must then be connected to the local exchange they belong to, according to the main cable structure. If there are not available spare pairs, a corresponding number of subscribers that use the defined direction of downstream transmission, have to be disconnected from the equalization cable. This group of subscribers must subsequently be connected to the local exchange they belong to. This procedure will exchange subscribers between two local exchanges, and some pairs in the equalization cable will be disconnected. No extra pairs are needed in any of the cables. Figure 9.2 shows a simple example where two subscribers are exchanged between Local exchange 1 and Local exchange 2 to solve this problem.



**Figure 9.2** Reconnection of an equalization cable in order to remove conflicting directions of transmission.

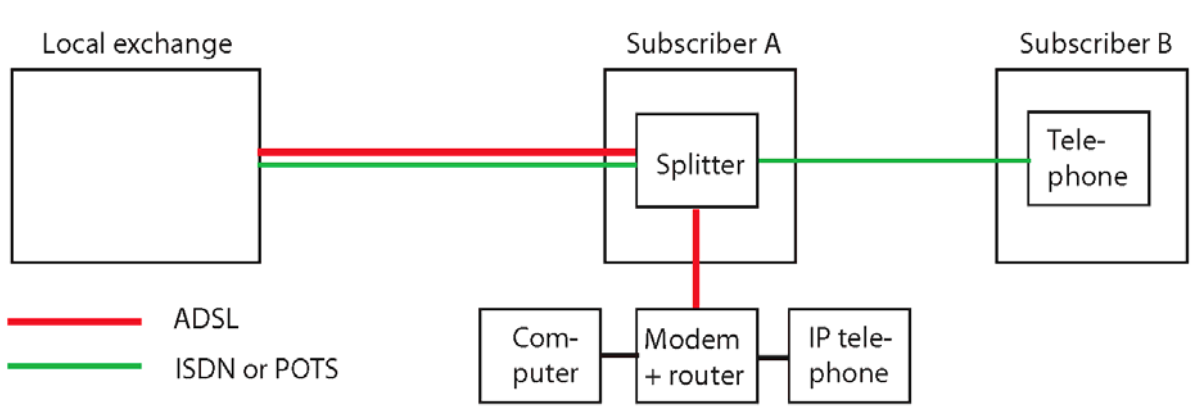
### 10 Alternative ways to install DSL in pairs that contain 1+1 systems

Due to shortage of pairs in the cable plant, it has been common to use 1+1 pair gain systems in order to provide telephony. If two subscribers share a common pair, it is not straightforward to provide ADSL to any of them, unless extra pairs are available in the cables.

In this section we will propose one approach to solve this problem without using extra pairs. We assume that subscribers A and B initially share a common line for telephony services. It is assumed that subscriber A is closest to the local exchange. We also assume that some kind of telephony service shall be maintained to both of the subscribers, and that one or both wants ADSL or a similar type of broadband service. This may be divided in three different cases:

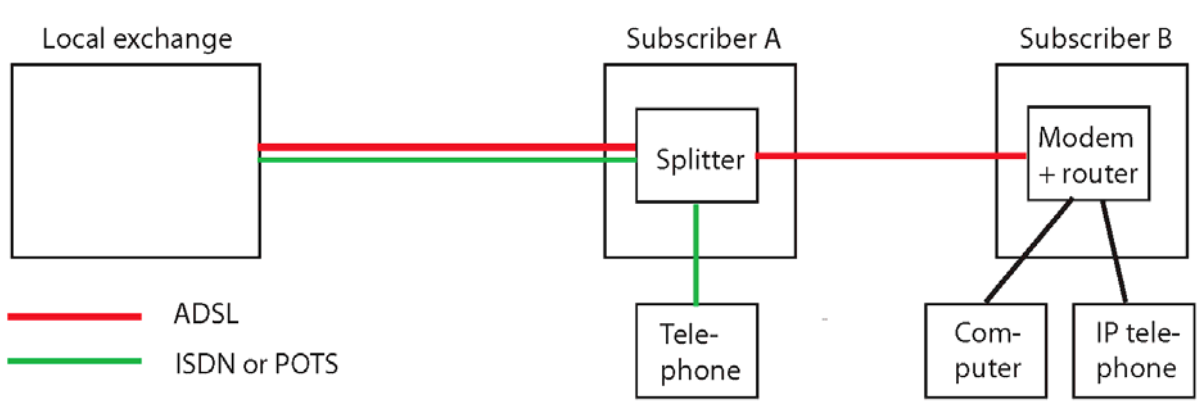
1. Subscriber A wants ADSL
2. Subscriber B wants ADSL
3. Both subscribers A and B want ADSL

The proposed solution for case 1 is shown in Figure 10.1. A splitter for ADSL/ISDN is installed at the premises of subscriber A. Subscriber A may have a full ADSL installation, but the telephone service for this subscriber has to be implemented as an IP telephone. Subscriber B will have access to the low frequency band, and may hence have an ordinary POTS service or ISDN.



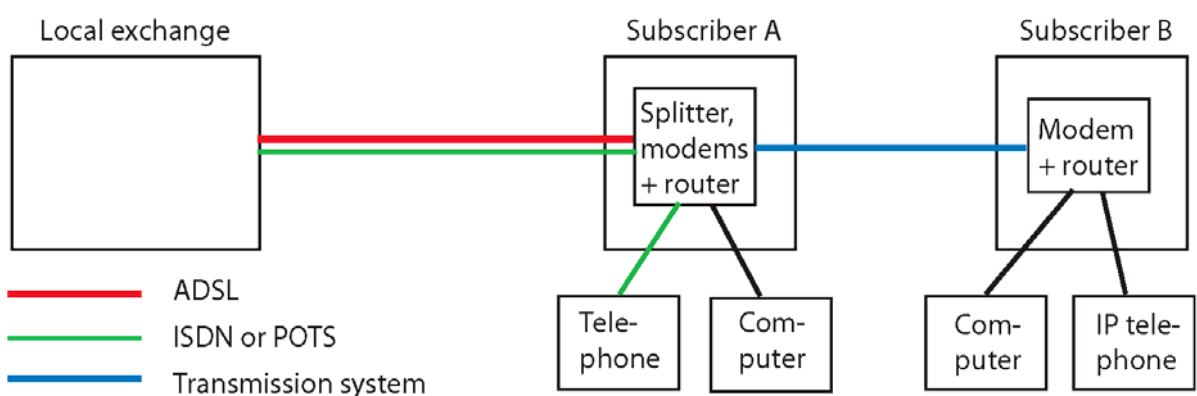
**Figure 10.1 Replacement of a 1+1 system where subscriber A wants ADSL.**

The proposed solution for case 2 is shown in Figure 10.2. A splitter for ADSL/ISDN is installed at the premises of subscriber A. Subscriber B may have a full ADSL installation, but the telephone service for this subscriber has to be implemented as an IP telephone. Subscriber A will have access to the low frequency band, and may hence have an ordinary POTS service or ISDN.



**Figure 10.2 Replacement of a 1+1 system where subscriber B wants ADSL.**

The proposed solution for case 3 is shown in Figure 10.3. A splitter for ADSL/ISDN is installed at subscriber A. Subscriber A will have access to the low frequency band, and may hence have an ordinary POTS service or ISDN. The two subscribers may form a common IP-zone that shares the capacity of the ADSL system. Subscribers A and B must be connected by some type of two-way transmission system. The telephone service of subscriber B has to be implemented as an IP telephone.



**Figure 10.3 Replacement of a 1+1 system where both subscriber A and subscriber B want ADSL.**

## 11 Conclusions

A comprehensive set of simulations has been carried out in order to estimate the potential performance of DSL systems in the Norwegian access network. An important objective has been to investigate important aspects of compatibility between different transmission systems in the network. The performance has been analyzed for different versions of SHDSL, ADSL, and VDSL, where the systems are subject to additional crosstalk from ISDN, HDSL, E1-systems and background noise.

The potential reach of SHDSL systems has been calculated for different alternatives of bitrates and alternative cases of interfering systems, both for 16-PAM and 32-PAM modulation. The reach is gradually reduced versus increasing bitrate. The highest bitrate for 16-PAM is 3.85 Mbit/s and gives a estimated reach of 1.2 to 1.6 km of 0.4 mm cable for typical situations of interference. The corresponding reach is 0.8 to 1.2 km for 5.7 Mbit/s 32-PAM systems.

The results for downstream ADSL show a potential bitrate higher than 6 Mbit/s up to approximately 2.8 km of 0.4 mm cable for typical situations of interference, and there is a significant decrease in bitrate for cable lengths beyond this limit. By doubling the bandwidth to 2.2 MHz in ADSL2+ the potential downstream bitrate is increased to typically 15 Mbit/s for cable length 1.5 km.

The results for upstream ADSL over ISDN show a typical potential bitrate of 0.8 Mbit/s for 2.8 km 0.4 mm cable. By also using the ISDN band for upstream transmission, the potential upstream bitrate of All Digital ADSL will typically be increased to 2.8 Mbit/s for 1.5 km cable length.

The major disturbing systems in downstream ADSL (ADSL/ADSL2+) are other ADSL systems, HDSL and SHDSL, and the potential bitrate is mainly determined by crosstalk from these types of systems. E1-systems may also be present, but will cause a dramatic reduction in bitrate and should be avoided. The SHDSL standard has recently been extended from 2.3 Mbit/s to 5.7 Mbit/s in an Annex G to the standard. A current critical issue is how the extended bitrates of SHDSL will reduce the performance of downstream ADSL systems. The results show that the potential bitrate of both downstream ADSL and downstream ADSL+ will be almost the same for crosstalk from 5.7 Mbit/s SHDSL with 32-PAM modulation as it is for crosstalk from current One-pair HDSL. The worst degradation of ADSL will be caused by 3.85 Mbit/s SHDSL with 16-PAM modulation. The maximum reduction in bitrate will be 7% for downstream ADSL compared to crosstalk from One-pair HDSL. The corresponding maximum reduction in bitrate will be only 3% for ADSL2+ in the most interesting loops lengths up to 2 km.

The performance of downstream ADSL and ADSL2+ has been calculated for ADSL subloops without power backoff. This demonstrates that ADSL subloop dramatically reduces the downstream bitrate, and that power backoff has to be used in all subloop systems, except systems installed very close to the main DSLAM.

The potential performance for VDSL according to the VDSL2 standard has been analyzed both for bandplan 997 and 998. The results show that bandplan 997 gives a more symmetrical system with respect to downstream and upstream bitrates than bandplan 998. Typical downstream/upstream bitrates will be 35/30 Mbit/s for bandplan 997 and 47/20 Mbit/s for bandplan 998 for 0.8 km of 0.4 mm cable.

The installation of ADSL in a network containing equalisation cables has been discussed. Equalisation cables may cause problems both due to differences in signal levels and because of conflicting directions of transmission. It has been shown by an example that conflicting directions of transmission may be removed by reconnection of pairs in equalization cables, and without installation of new cables.

In cases where two subscribers share one copper pair for telephony in an 1+1 system, it may be difficult to install ADSL. Possible solutions to this problem have been presented both for the case where one of the subscribers or both wants broadband access.



## References

- [1] N. Holte, V. Ringset, "Plan for the use of frequencies in the Norwegian access network – a proposal," SINTEF report STF40-F02024, Trondheim, June 2002.
- [2] ITU-T Recommendation G.996.1, "Test procedures for digital subscriber line (DSL) transceivers", Geneva, Feb. 2001.
- [3] ETSI Technical Report ETR328, "Transmission and Multiplexing (TM), Asymmetrical Digital Subscriber Line (ADSL); Requirements and Performance".
- [4] ITU-T Recommendation G.961, "Digital transmission system on metallic local lines for ISDN basic rate access", Geneva, March 1993.
- [5] Tekniske spesifikasjoner for operatøraksess,  
[http://www.jara.no/produktlosninger/ovrige/pdf/tekniske\\_spesifikasjoner01012006.pdf](http://www.jara.no/produktlosninger/ovrige/pdf/tekniske_spesifikasjoner01012006.pdf)
- [6] ITU-T Recommendation G.991.1, "High bitrate digital subscriber line (HDSL) transceivers", Geneva, Oct. 1998.
- [7] ITU-T Recommendation G.991.2, "Single-pair high-speed digital subscriber line (SHDSL) transceivers", Geneva, Dec. 2003.
- [8] ITU-T Recommendation G.992.1, "Asymmetric digital subscriber line (ADSL) transceivers", Geneva, June 1999.
- [9] ITU-T Recommendation G.992.3, "Asymmetric digital subscriber line transceivers 2 (ADSL2)", Geneva, Jan. 2005.
- [10] ITU-T Recommendation G.992.5, "Asymmetric Digital Subscriber Line (ADSL) transceivers – Extended bandwidth ADSL2 (ADSL2+)", Geneva, Jan. 2005.
- [11] ITU-T Recommendation G.993.1, "Very high speed digital subscriber line transceivers", Geneva, June. 2006.
- [12] ITU-T Recommendation G.993.2, "Very high speed digital subscriber line transceivers 2 (VDSL2)", Geneva, Feb. 2006.
- [13] ITU-T Recommendation G.703, "Physical/electrical characteristics of hierarchical digital interfaces", Geneva, 1998.
- [14] E. A. Lee, D. G. Messerschmitt, "Digital Communications," 2<sup>nd</sup> ed., Kluwer, Boston 1994.
- [15] H. Kaden, "Wirbelströme und Schirmung in der Nachrichtentechnik", Springer-Verlag, Berlin 1959.
- [16] S. Nordblad, "Multi-paired Cable of nonlayer design for low capacitance unbalance telecommunication networks," Int. Wire and cable symp., 1971, pp. 156-163.
- [17] N. Holte, "Krysstale i abonnentkabler, sluttrapport," SINTEF rapport nr. STF44 F85001, Trondheim, januar 1985.