

SINTEF Building and Infrastructure Børge Johannes Wigum (editor)

Workshop on Manufactured Sand, Stavanger, Norway 30–31 October 2008

COIN project report 79 – 2015



SINTEF Building and Infrastructure

Børge Johannes Wigum (editor)

Workshop on Manufactured Sand, Stavanger, Norway 30–31 October 2008

FA: Competitive constructions

SP 2.3 Production of high quality manufactured aggregate for concrete

COIN Project report 79 – 2015

COIN Project report no 79

Børge Johannes Wigum (editor)

Workshop on Manufactured Sand, Stavanger, Norway 30-31 October 2008

FA: Competitive constructions

SP 2.3 Production of high quality manufactured aggregate for concrete

Keywords:

Concrete aggregates; manufactured sand

Project no.: 102000442-5

Photo, cover: «Pipes», iStock

ISSN 1891-1978 (online)

ISBN 978-82-536-1496-0 (pdf)

© Copyright SINTEF Building and Infrastructure 2015

The material in this publication is covered by the provisions of the Norwegian Copyright Act. Without any special agreement with SINTEF Building and Infrastructure, any copying and making available of the material is only allowed to the extent that this is permitted by law or allowed through an agreement with Kopinor, the Reproduction Rights Organisation for Norway. Any use contrary to legislation or an agreement may lead to a liability for damages and confiscation, and may be punished by fines or imprisonment.

Address: Forskningsveien 3 B
POBox 124 Blindern
N-0314 OSLO

Tel: +47 73 59 30 00

Fax: +47 22 69 94 38

www.sintef.no/byggforsk

www.coinweb.no

Cooperation partners / Consortium Concrete Innovation Centre (COIN)

Kværner Engineering

Contact: Jan-Diederik Advocaat

Email: Jan-Diederik.Advocaat@kvaerner.com

Tel: +47 67595050

Mapei AS

Contact: Trond Hagerud

Email: trond.hagerud@mapei.no

Tel: +47 69972000

Norwegian Public Roads Administration

Contact: Kjersti K. Dunham

Email: kjersti.kvalheim.dunham@vegvesen.no

Tel: +47 22073940

Saint Gobain Weber

Contact: Geir Norden

Email: geir.norden@saint-gobain.com

Tel: +47 22887700

SINTEF Building and Infrastructure

Contact: Tor Arne Hammer

Email: tor.hammer@sintef.no

Tel: +47 73596856

Unicon AS

Contact: Stein Tosterud

Email: stto@unicon.no

Tel: +47 22309035

Norcem AS

Contact: Terje Rønning

Email: terje.ronning@norcem.no

Tel: +47 35572000

Skanska Norge AS

Contact: Sverre Smeplass

Email: sverre.smeplass@skanska.no

Tel: +47 40013660

Veidekke Entreprenør ASA

Contact: Christine Hauck

Email: christine.hauck@veidekke.no

Tel: +47 21055000

NTNU

Contact: Terje Kanstad

Email: terje.kanstad@ntnu.no

Tel: +47 73594700



MANUFACTURED SAND WORKSHOP

STAVANGER, NORWAY,
OCTOBER 30TH AND 31ST 2008

SUMMARY OF PRESENTATIONS

COIN Version

November 2008

MANUFACTURED SAND - WORKSHOP

Stavanger, Norway, October 30th and 31st 2008



Introduction

As part of the COIN project, an International Workshop on the topic of production and use of manufactured sand aggregates was held at Hummeren hotel in Stavanger, Norway, on October 30th and 31st 2008..

The motivation for this workshop is the increasing miss balance between the need for aggregates in the society and the availability of traditionally suitable geologic sources. We see a strong need for developing and implementing technology that can enable the use of alternative resources, reduce the need for transport and present zero waste concepts for the aggregate and concrete industry.

The main aim of this workshop was to create opportunity for professional development, for information sharing and dissemination. We wanted this workshop to be an arena for interactive exchange of experiences between the participant., regarding one of the following topics:

- Sustainability and environmental challenges
- Geological and mineralogical issues
- Production (extraction, crushing, sieving, washing)
- Use of manufactured sand in concrete; mix design
- Characterization and testing of fines
- Standards and specifications
- Alternative utilization of fines
- Cases

In total 25 participants from 9 countries participated in the workshop, where a total of 18 lectures were presented. The participations represented various parties of the aggregate business, from production to utilisation, including; geologists, aggregate producers, machinery engineers (producers and users), concrete admixture producers, researchers and concrete producers.

This report contains the slides presented at the workshop, including short abstracts for some of the presentations.

MANUFACTURED SAND - WORKSHOP
 Stavanger, Norway, October 30th and 31st 2008

Participants

Name	Company	Country
Chris Rogers		Canada
Jouni Mähönen	Metso Minerals	Finland
Jarmo Eloranta	Metso Minerals	Finland
Guðmundur Símonarsson	Björgun	Iceland
Makoto Hashimoto	Kotobuki Engineering and Manufacturing Co. Ltd	Japan
Takato Kaya	Kotobuki Engineering and Manufacturing Co. Ltd	Japan
Torben Jepsen	JGO-Betong	Norway
Peer Richard Neeb	NGU	Norway
Dan Arve Juvik	Rescon Mapei	Norway
Bård Pedersen	NorStone	Norway
Svein Willy Danielsen	SINTEF Byggforsk	Norway
Odd Hotvedt	Kolo Veidekke	Norway
Lillian Uthus Mathisen	Kolo Veidekke	Norway
Gaute Veland	NorStone	Norway
Børge Johannes Wigum	Norwegian University of Science and Technology	Norway
Roar Nålsund	Norwegian University of Science and Technology	Norway
Lukasz Debny	Grace	Poland
Niklas Skoog	Sand & Grus AB Jehander	Sweden
Hans-Erik Gram	Cemeta	Sweden
Bjørn Schouenborg	CBI Betonginstituttet	Sweden
Sven-Henrik Norman	Metso Minerals	Sweden
Per Hedvall	Sandvik	Sweden
Magnus Evertsson	Chalmers University of Technology	Sweden
Jose M. Cuevas	AIDICO	Spain
Hugo Pettingell	Hugo Pettingell Mineral Services	UK

MANUFACTURED SAND - WORKSHOP
Stavanger, Norway, October 30th and 31st 2008



Participants:

Upper row from left: Sven-Henrik Norman, Jarmo Eloranta, Guðmundur Símonarsson, Chris Rogers, Børge Johannes Wigum, Magnus Evertsson, Per Hedvall, Bjørn Schouenborg.

Lower row from left: Jouni Mähönen, Gaute Veland, Svein Willy Danielsen, Bård Pedersen, Dan Arve Juvik, Odd Hotvedt, Niklas Skoog, Lukasz Debny, Hans-Erik Gram, Makoto Hashimoto, Hugo Pettingell, Jose M. Cuevas, Takato Kaya.

In front from left: Per-Richard Neeb and Roar Nålsund.

Not present: Lillian Uthus Mathisen and Torben Jepsen.

Organizers

COIN - Concrete Innovation Centre

The workshop is arranged as part of the COIN project. COIN stands for Concrete Innovation Centre and is one of 14 Norwegian centres for research-based innovation (CRIs) that was established by the Research Council of Norway in 2006. The vision of COIN is creation of more attractive concrete buildings and constructions. Attractiveness implies – among others – aesthetics, functionality, sustainability, energy efficiency and cost efficiency during the whole service life. The primary goal is to fulfil this vision by bringing the development a major leap forward by more fundamental understanding of the mechanisms in order to develop advanced materials, efficient construction techniques and durable design concepts combined with more environmentally friendly material production. The corporate partners are leading multinational companies in the cement and building industry and the aim of COIN is to increase their value creation and strengthen their research activities in Norway. COIN will run from 2007 to 2014 with a total budget of about €25 million.

Organizing committee:

Svein Willy Danielsen, SINTEF Building and Infrastructure
Børge Johannes Wigum, Norwegian University of Science and Technology
Odd Hotvedt, Kolo Veidekke
Bård Pedersen, NorStone

Content of Presentations

Svein Willy Danielsen, <i>SINTEF Building and Infrastructure</i> ; Concrete aggregates from crushed hard rock – why, -where, how?	7-22
Peer R. Neeb, <i>Geological Survey of Norway</i> ; Sustainable management of aggregate resources in Norway, extraction and export.	23-39
Odd Hotvedt, <i>Kolo Veidekke</i> ; Manufactured sand – Two cases; The Concrete Dam; “Førrevassdammen”, 1982-1986 & Norsk Stein 1993.	41-54
Jarmo Eloranta, <i>Metso</i> ; Barmac/HP sand. Case in US. Tests run during May and August 2006 (Soft rock).	55-64
Björn Schouenborg, <i>CBI, A group in the SP group</i> ; Microstructure versus mechanical properties and influence on aggregate production.	65-86
Niklas Skoog, <i>Sand & Grus AB Jøhander</i> ; Manufactured sand in concrete. Experience from laboratory and full scale tests in Göteborg.	87-93
Chris Rogers: Experience with Manufactured Sands in Canada.	95-111
Sven-Henrik Norman, <i>Metso</i> ; Air Classification. A method to adjust fine aggregate gradation.	113-121
Per Hedvall, <i>Sandvik</i> ; Sandvik Sand.	123-131
Makoto Hashimoto, <i>Kotobuki Engineering and Manufacturing Co. Ltd</i> ; Kemco Dry Sand-Making System V7. To turn surplus crusher dust into premium sand.	133-150
Magnus Evertsson, <i>Chalmers University of Technology</i> ; Development of Crushing Technology for Manufactured Sand.	151-167
Bård Pedersen, <i>NorStone</i> ; A preliminary study on manufactured sand in concrete. Effect of grading and fines content.	169-175
Lukasz Debny, <i>Grace</i> ; Comparison of rheological and mechanical properties of mortars prepared with manufactured and natural fine aggregates.	177-182
Dan Arve Juvik, <i>Rescon Mapei</i> ; Casting of concrete made by crushed aggregate.	183-198
Jouni Mähönen, <i>Metso</i> ; Example of how to evaluate shape of fine aggregate. Sand flow cone NZS 3111:1986.	199-203
Hans-Erik Gram, Björn Lagerblad and Mikael Westerholm, <i>Cementa and CBI</i> ; Characterization of crushed rock sands in Sweden.	205-229
Chris Rogers; A flakiness test for fine aggregate.	231-269
Jose M. Cuevas, <i>ADICO</i> ; Limitation of the fine particles content in the aggregates for concrete.	270-277

Concrete aggregates from crushed hard rock - why, - where, - how?

Svein Willy Danielsen
SINTEF Building and Infrastructure

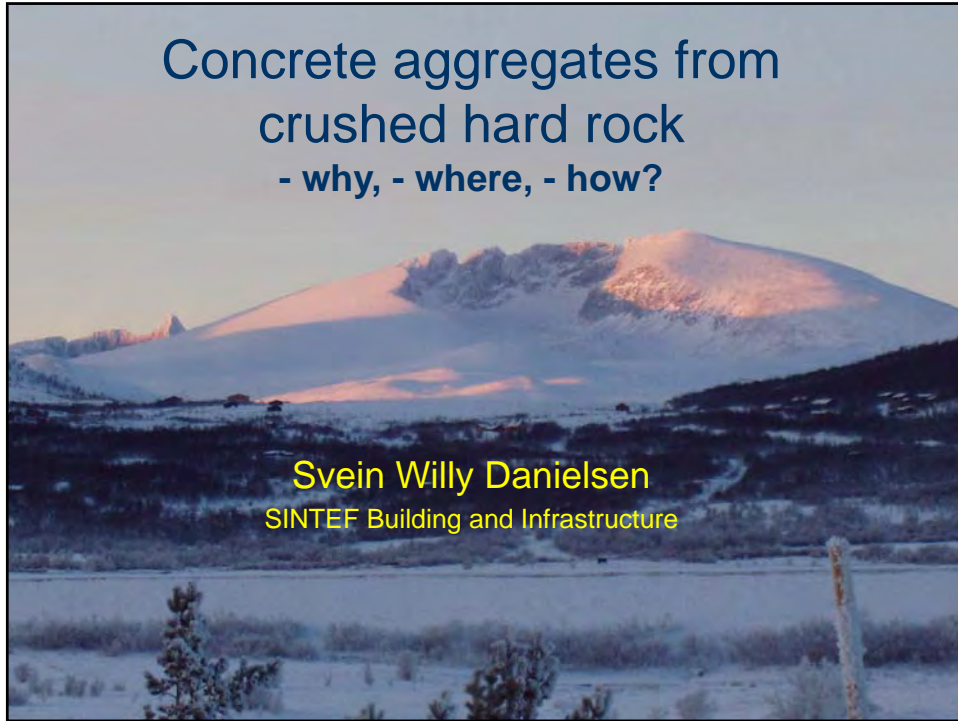

By considering the development in construction activities, we can estimate that close to 80% of the sand/gravel ever taken out of the nature, has been consumed in our generation.

How do we continue from there?

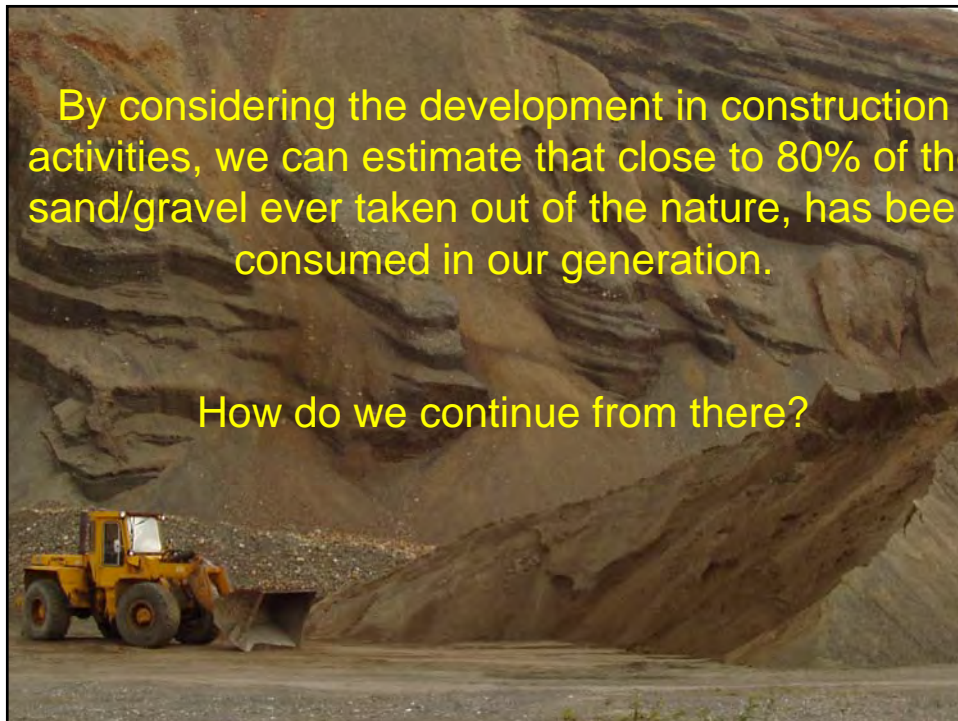

The availability of materials will be one of the important global market drivers in the years to come

(Prof. Roger Flanagan UK)

 SINTEF Building and Infrastructure  3

Mineral aggregates can only be extracted where nature has placed them

So quarries may have to be located in the countryside where constraints against development are intense.

Or alternatively in densely populated areas with protests against dust, noise and traffic

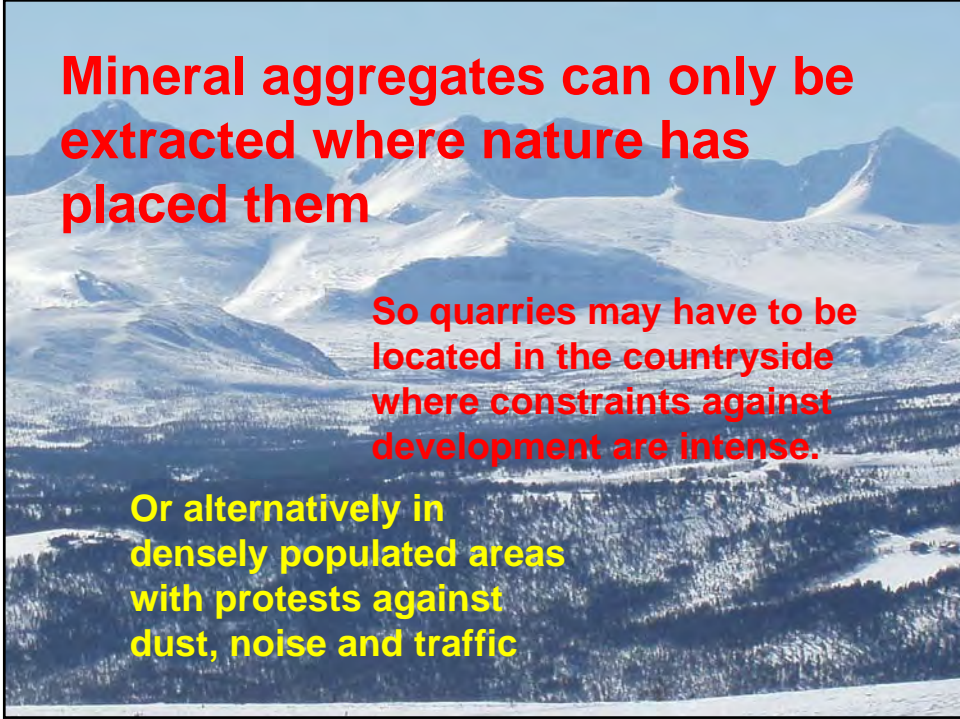

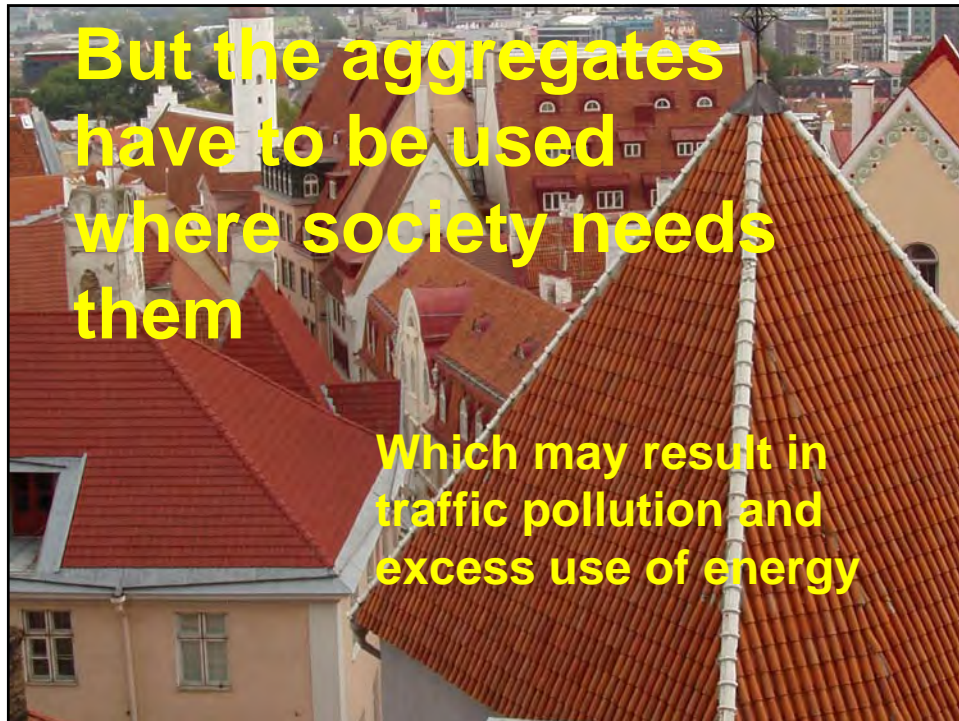

Some international key figures

- Global demand for aggregates is some 15 billion tons/year
- Expected to increase to 22 billion, where China alone will account for some 6 billion
- European aggregate industry produced >3 billion tons in 2005, at a value of >40 billion €
 - 47 % sand/gravel, 45 % crushed hard rock
 - The remaining part was recycled and artificial materials
 - Production took place in 28.000 quarries
- European concrete production is almost 600 mill m³, and uses approx 1,2 billion tons of aggregates per year

- Europe has approx 500 mill people
 - Expected average consumption of mineral aggregates 10 tons per capita
 - ➔ Total of 5 bill tons per year Europe wide
 - Assuming an average equivalent road transport distance of 40 km
 - ➔ 200 billion ton-km per year for aggregate transport
- 2 questions:
 - Where do we find these resources on a long range?
 - What is the CO2 emission per ton-km?

Aggregates - EU30 trade in 2001

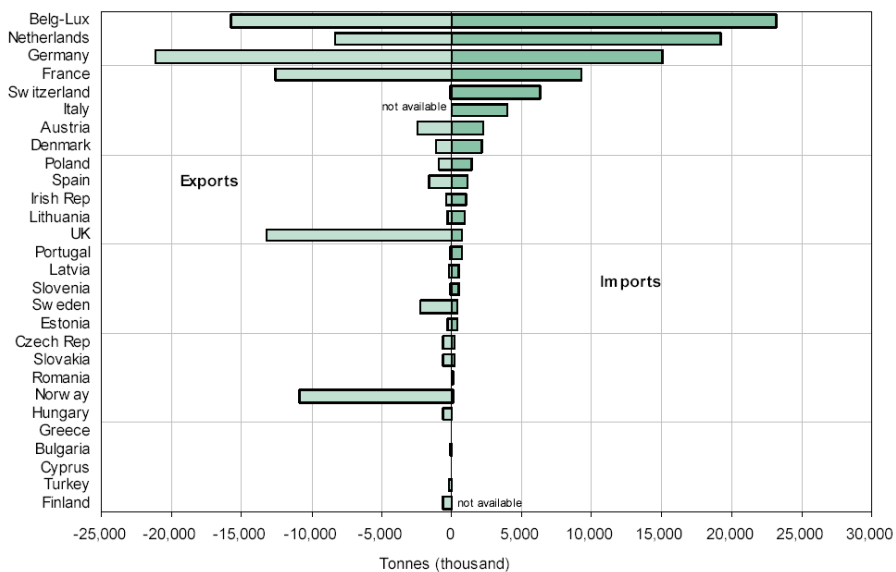

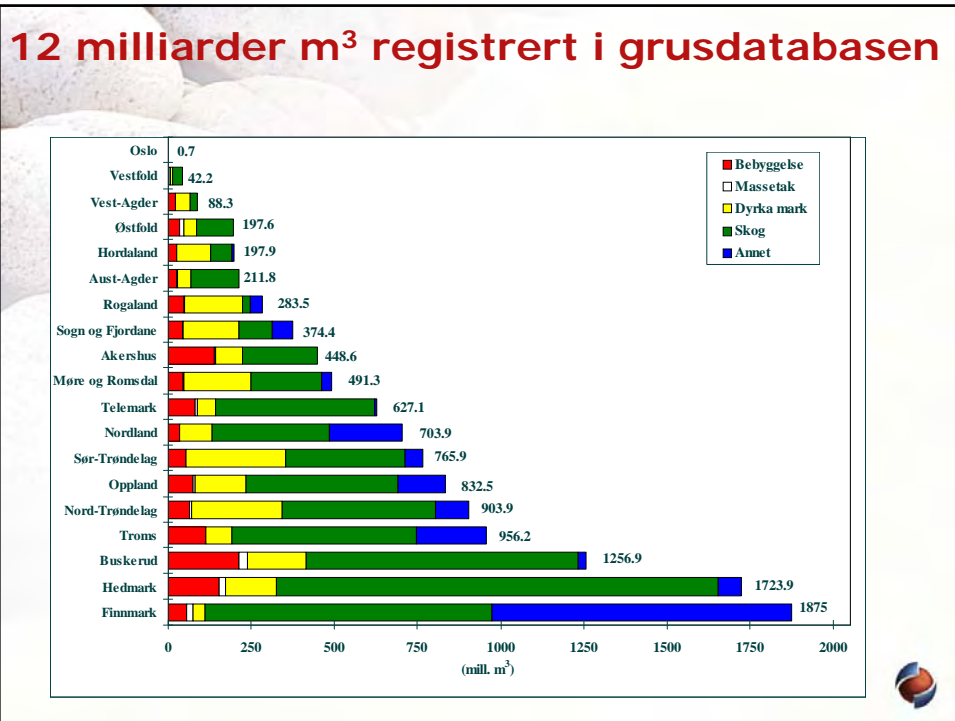

European aggregate statistics 2005 (UEPG), some selected countries

Mill tons	Sand/ gravel	Crushed hard rock	Recycled and artificial	TOTAL	Quarries
Norway	15	38	0,2	53,2	4600
Sweden	23	49	8,1	80,1	1840
Germany	263	174	76	513	3180
UK	124	85	68	277	1300
TOTAL All countries	1445,4	1362,2	237,8	3045,4	28339

% distribution for some countries

	%	Crushed	Recycled	Of European total prod.	Of Eur. no. of quarries
Norway		72	<<1	1,8	16
Sweden		61	10	2,6	6,5
Netherlands		8	42	1,6	0,7
Germany		34	9	17	11
UK		31	20	9	4,6
France		54	2,5	13,5	9,5
Spain		65	<<1	15	6,8

Development in sand/gravel versus crushed rock (Norway)

Year	Production value mill. NOK					Mill. t 2002
	1982	1991	1997	2000	2002	
Sand/gravel	1000	900	900	760	590	15
Crushed hard rock	800	1350	1859	1825	1950	35
Total	1800	1920	2759	2585	2540	50
% sand/gravel	56	47	33	29	23	

Some key items to be handled

- Local resources, local production – to reduce long range, polluting transport
- How do we handle that when existing resources are depleted – and access to new ones are limited?
- “Secondary materials”, and the use of all available sizes – for a zero-waste production
- Adaptation of requirements and materials design to the local resources available – instead of standard “ideal” designs
- Can we (and must we) invent an all-new materials technology?
- Densely populated areas – combining sub surface quarrying with the cities’ need for underground space?

Sustainability:

Resource management is the key

– access to resources the main challenge.

Any encroachment upon nature should be justified by increased values for the society, both relating to the products made and to the area left for later use.

Four essential phases in aggregate business

1. Inventory and planning
2. Quarrying and production
3. Use of aggregates in construction
4. Reclamation of mined-out area

Inventory and planning:

1. Geological mapping
2. Regulatory issues
3. Planning of the future exploration and quarrying
4. Planning of the future land reclamation



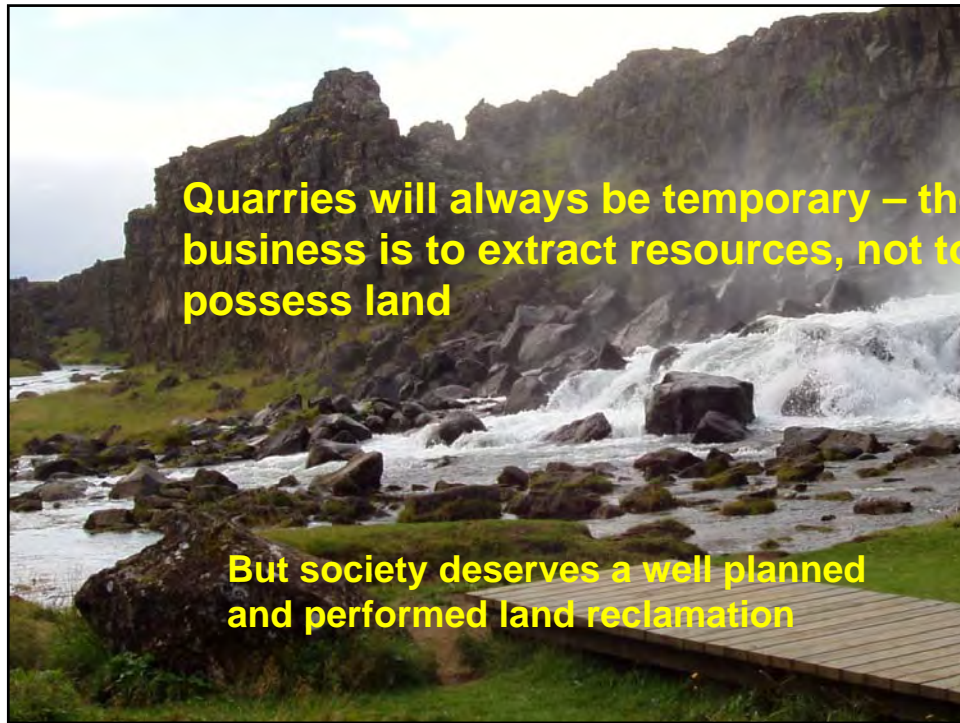

Aggregate technology

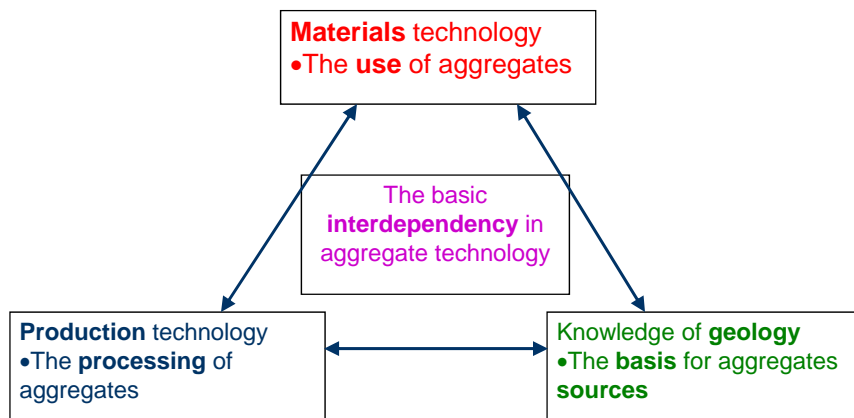

Quarrying and production

- Extraction
- Handling and transport
- Production – crushing, classifying
- Storing
- Waste depositing



Use of aggregates in construction

Concrete mix design,
performance based or
standard
requirements?

Performance analyses

Quality control

Materials proportioning

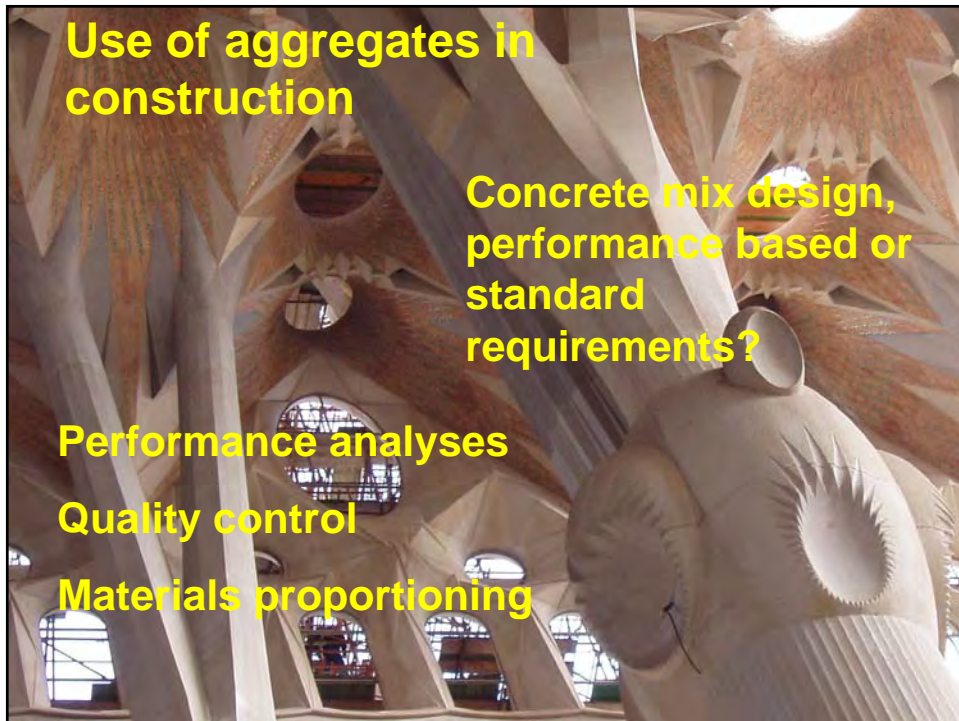

What can we achieve by using crushed rock aggregates in concrete?

- New developed technology opens new possibilities
 - Aggregate production
 - Concrete proportioning
- Utilise the properties of different rock types
 - More design opportunities
- Have a more industrialised production
 - Less surprises
- Utilise surplus sizes
 - Mass balance
 - Less need for fines deposits – *"no-waste production"*

Pre-conditions to make concrete with exclusively crushed aggregates:

Suitable rock type

Control of the 0-2 mm grading

Cubicity in the medium grain size fraction

Specific proportioning
– not just replace the natural sand

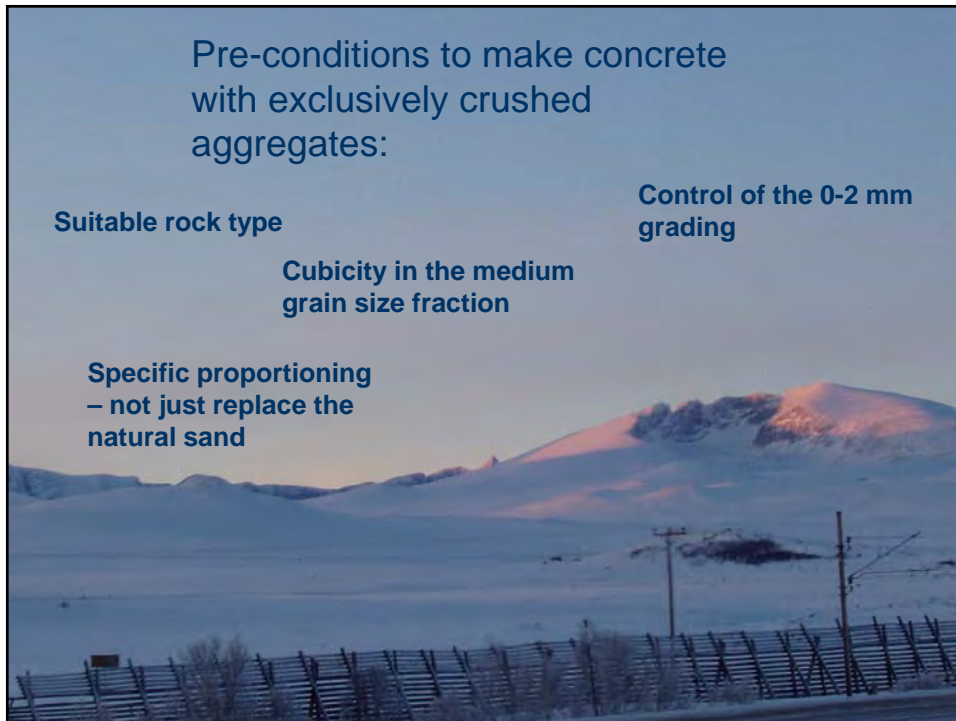

Materials technology has to a large degree been developed in dependence of the aggregate resources available, and thus of the local/regional geological conditions



Crusher Particle Shape



■ Secondary and Tertiary Compression Crusher Sand



■ **BarmacSAND™**

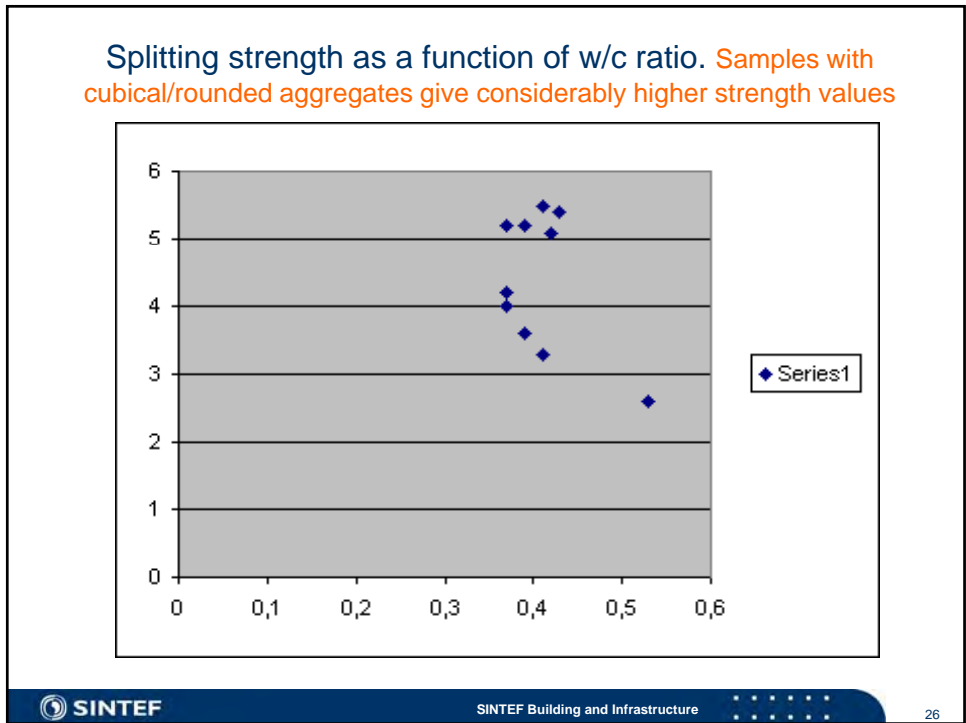
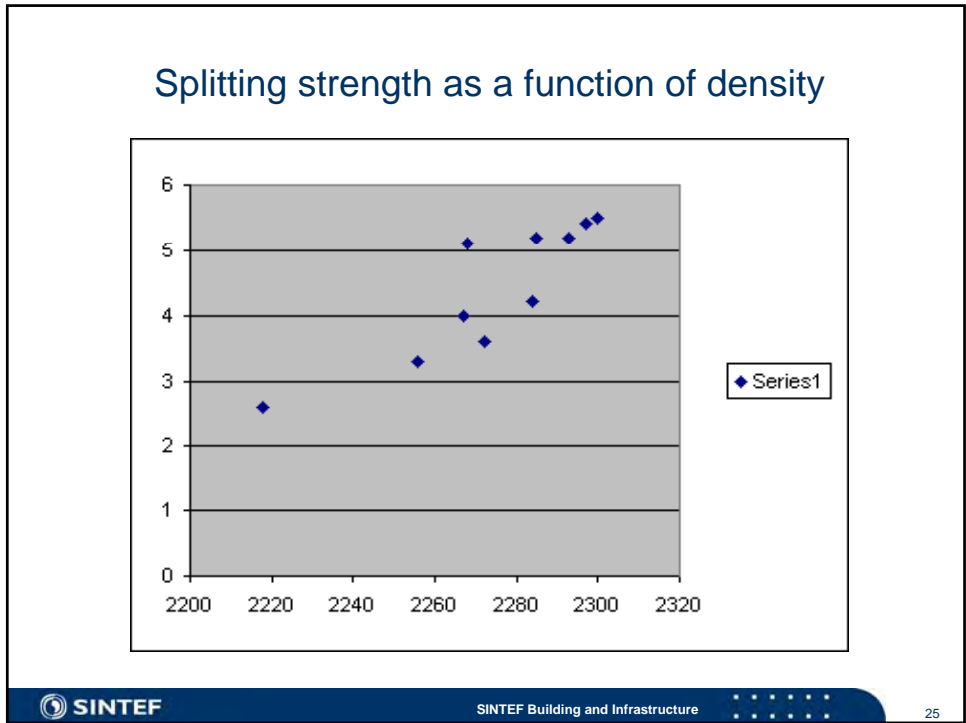

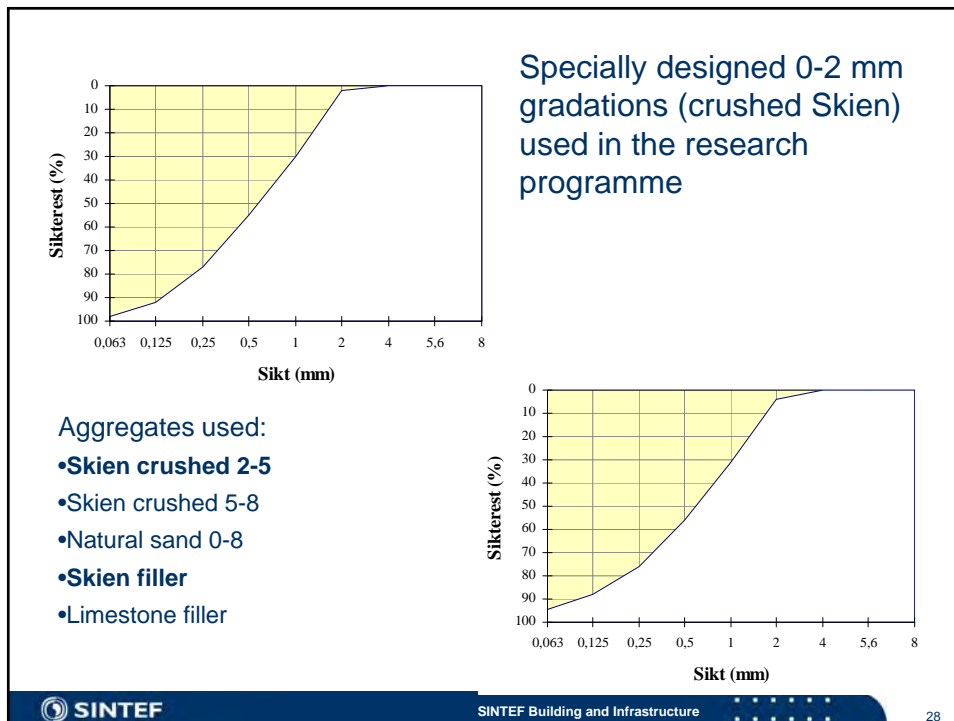
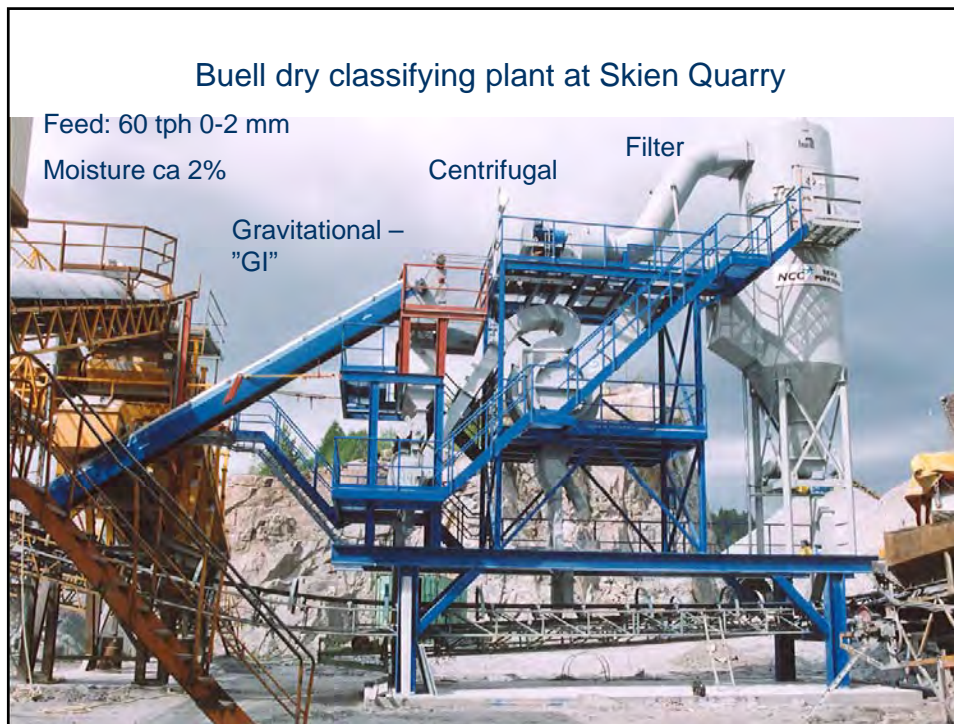

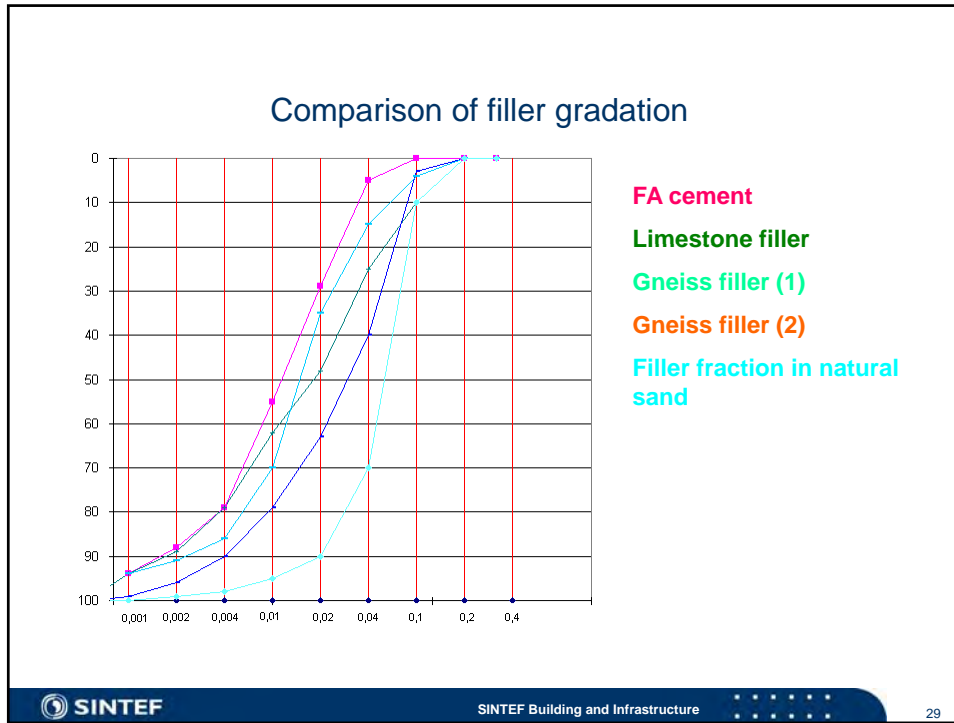

Future action and research

1. Tools for mineral resource management
2. Concepts and technologies for optimum production and use

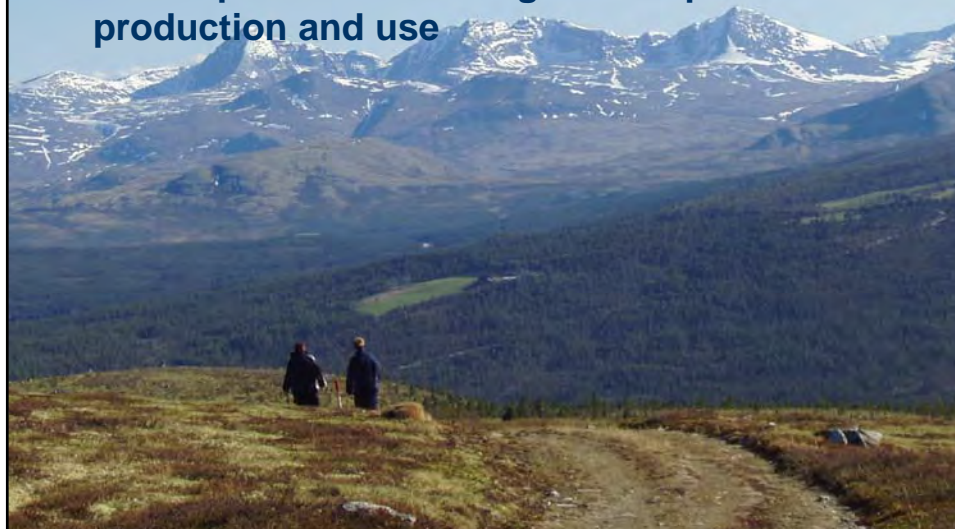

Research topics

- Concepts for **competitive use of manufactured aggregates**
- Technology to **benefit from specific rock properties**
- Utilisation of **secondary aggregates /marginal resources**
- Concepts to constantly obtain **mass balance** (100% utilisation)
- Concepts to **use more kinds of local materials**, all new materials technology?
- **Integrated plant** concepts, with cost effective production
- More economically feasible **subsurface quarrying**, combined with establishing underground space

Crushed hard rock aggregates for concrete

- A need
- A challenge
- And an opportunity



Sustainable management of
aggregate resources in Norway,
extraction and export



Peer-Richard Neeb, Stavanger 30. October 2008
Geological Survey of Norway



Geological Survey of Norway
Goals 2008-2012

- Better knowledge of nature and environment
- ➡ **Economic growth in the mineral industry**
- Better planning and land management
- International co-operation and development



Mineral resources in Norway

The mining and quarrying industry comprises companies engaged in extracting and processing minerals and rocks from bedrock or superficial deposits.

Five categories of raw materials are distinguished:

- ➔ **industrial minerals (e.g. limestone, quartz and nepheline syenite)**
- ➔ **building stone derived from dimension stone (e.g. larvikite, granite and flagstone)**
- ➔ **raw materials for construction (sand, gravel, crushed rock and clay)**
- ➔ **metallic ores (iron, nickel and titanium oxide) energy minerals (coal).**



Mineral raw materials in use

The diagram illustrates the diverse applications of mineral raw materials in Norway. It shows a cross-section of the ground and the flow of materials from extraction to various uses. Key materials and their applications include:

- Industrial Minerals:** Aluminum, steel, titanium, titanium oxide, nepheline syenite, quartz, and mica.
- Building Stone:** Larvikite, granite, flagstone, and natural stone.
- Construction Materials:** Concrete roof tiles, bricks from clay and olivine, roofing slate, concrete reinforcement, concrete sleepers, and aggregates (sand, gravel, crushed rock).
- Other Materials:** Limestone, talc, kaolin, feldspar, granite, marble, and rock wool.

The diagram also shows the geological layers of the ground, including till, sand/gravel, aggregate, and bedrock. A small NGU logo is visible in the bottom right corner.

Norway's aggregate industry in 2007

- Total turnover: € 500 million.
- 51 million tonnes hard rock.
- 15 million tonnes sand and gravel.
- Export sales: € 83 million.
- 13 million tonnes exported.
- 640 operators, ranging from small enterprises to international companies.
- Provides the backbone of many communities.
- Export from coastal areas.
- Potential for further growth.

Information on resources – Data acquisition

- Fieldwork, mapping
- Laboratory investigations
 - Los Angeles method
 - Polished Stone Value
 - Nordic abrasion value
 - Micro-deval
 - Microscopy
 - Etc.
- Data interpretation
- Data presentation



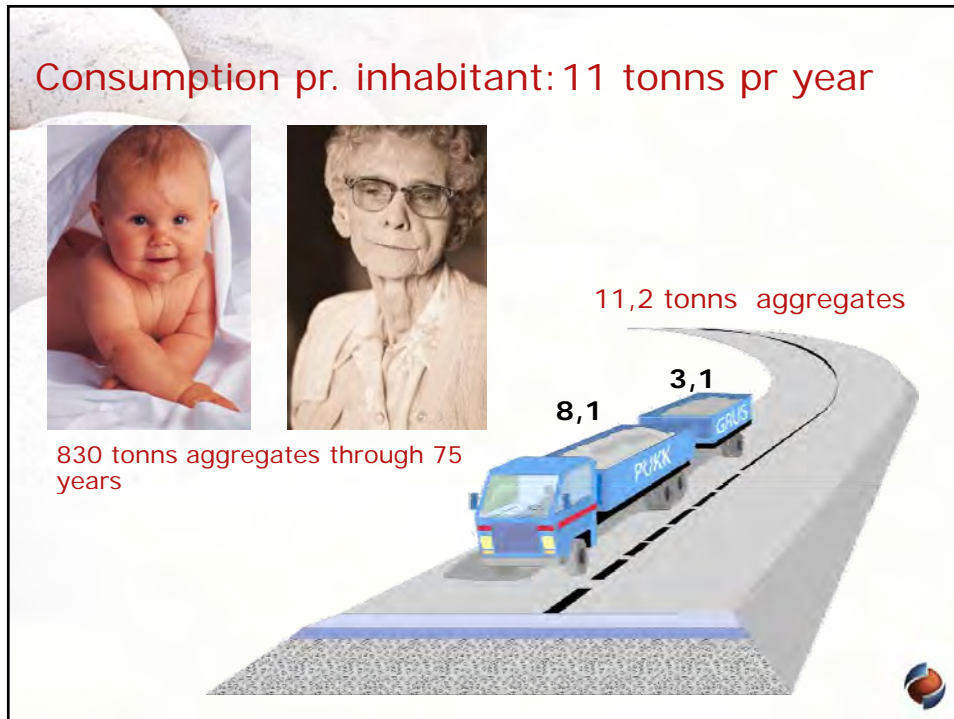
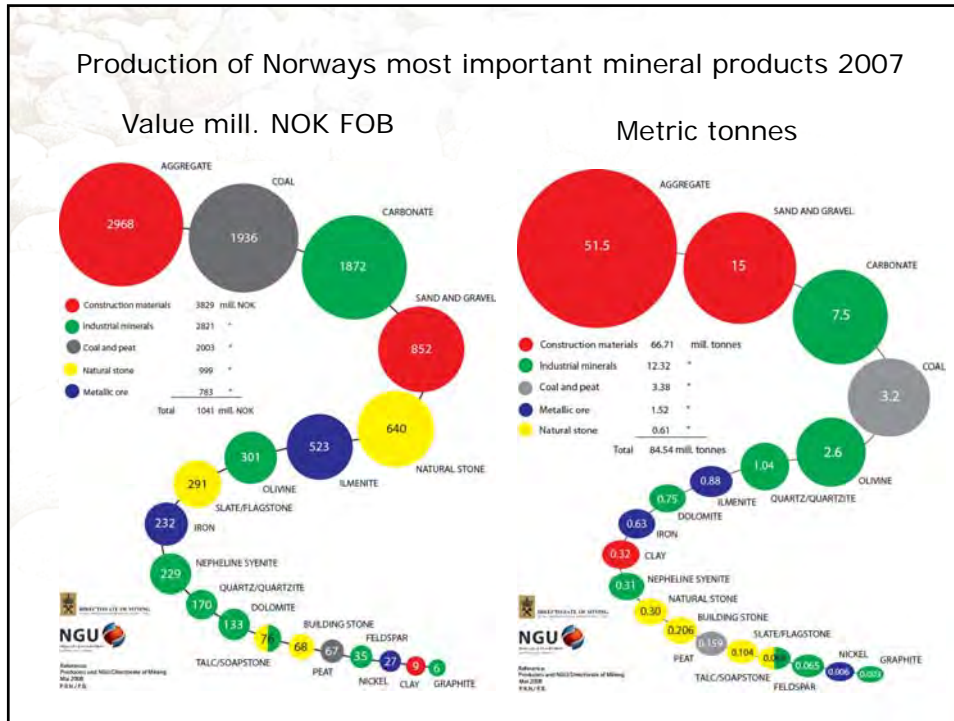

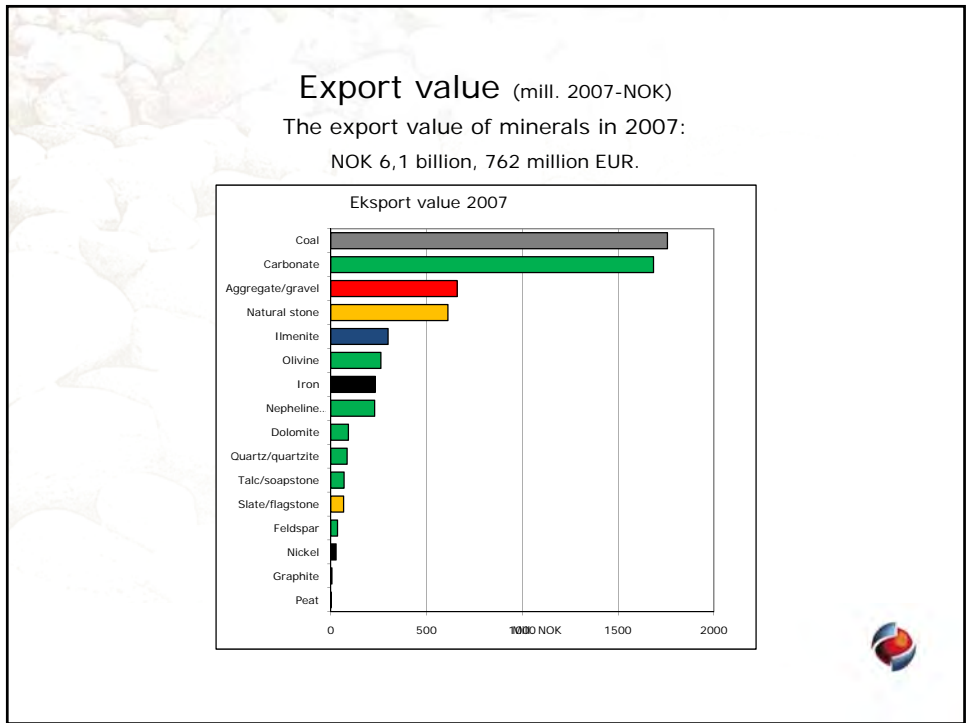
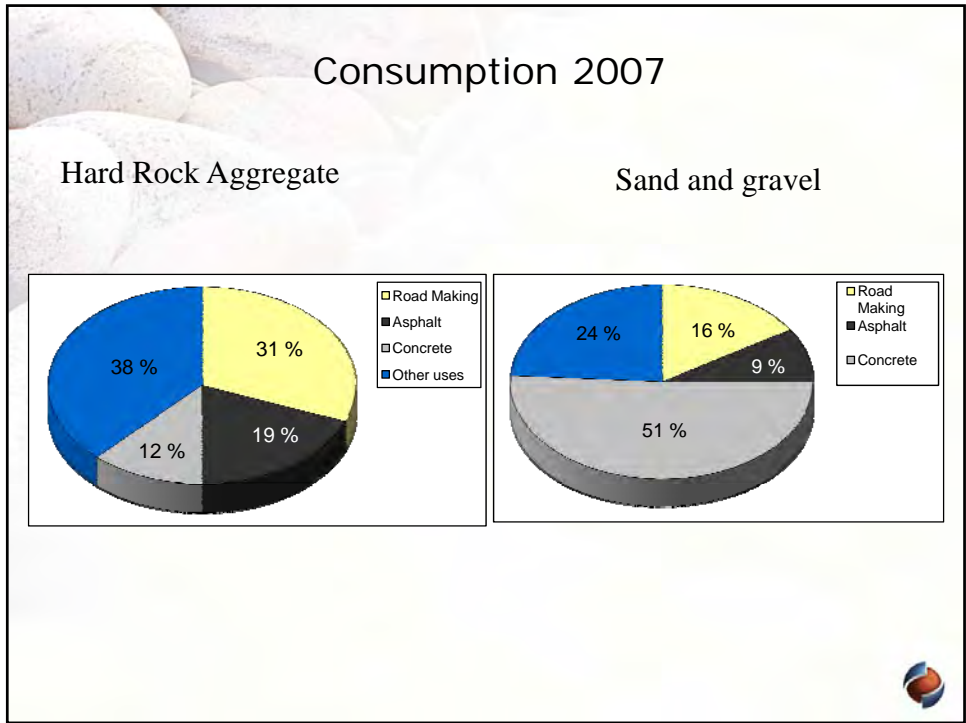

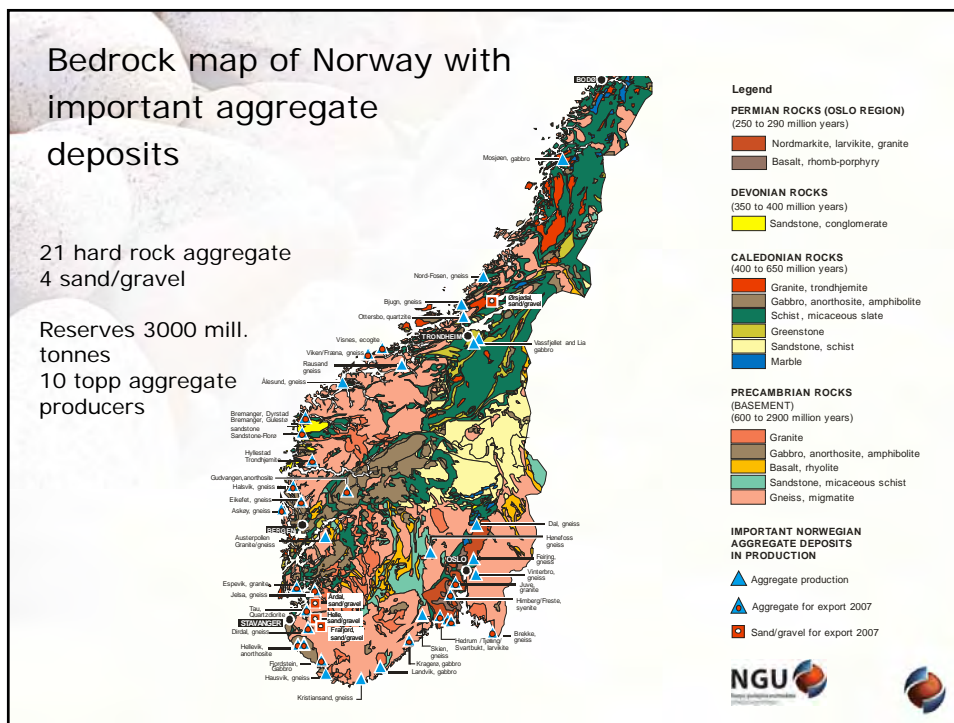
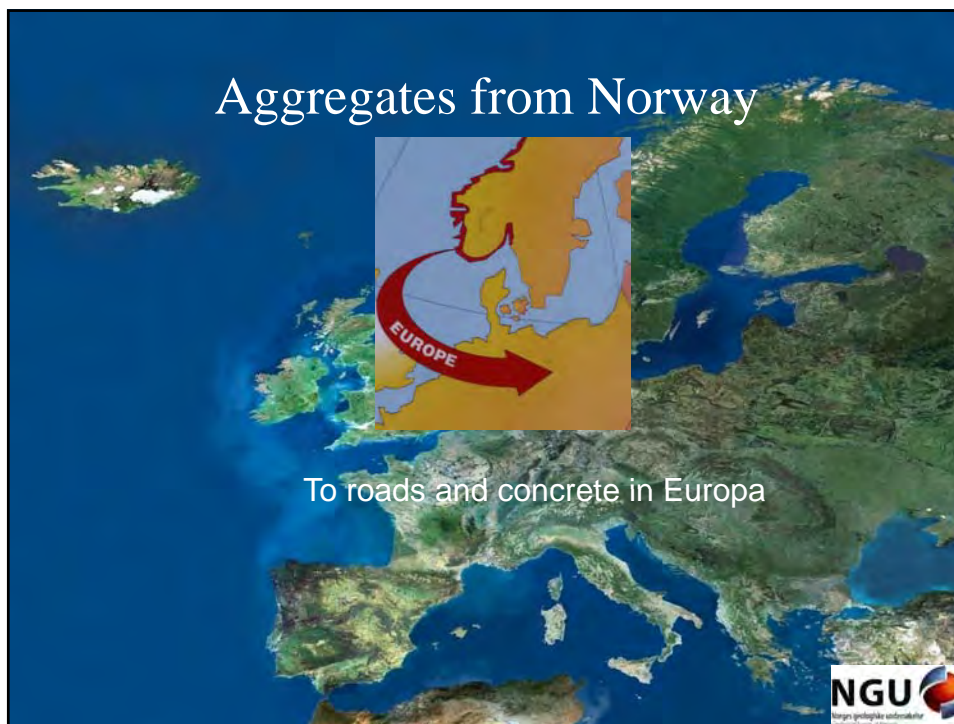

Norwegian aggregate export 2007



Aggregate/armourstone 13,4 mill. tonnes
 Sand/gravel 0,2 mill. tonnes
 Exportvalue 660 mill. NOK/83 mill EUR
 Offshore aggregate 2,0 mill. tonnes

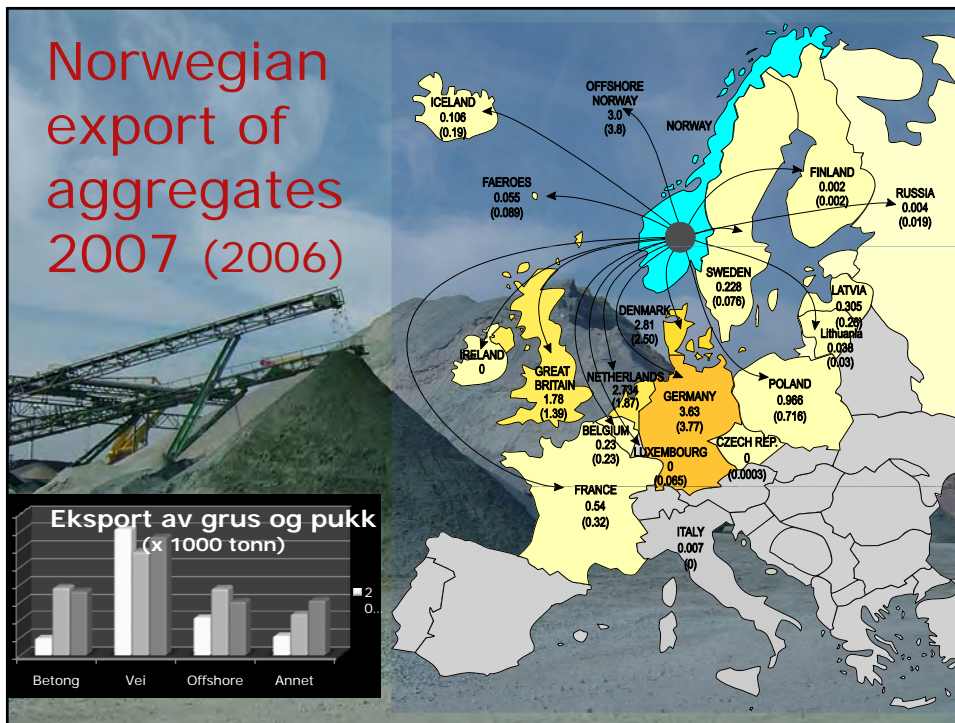
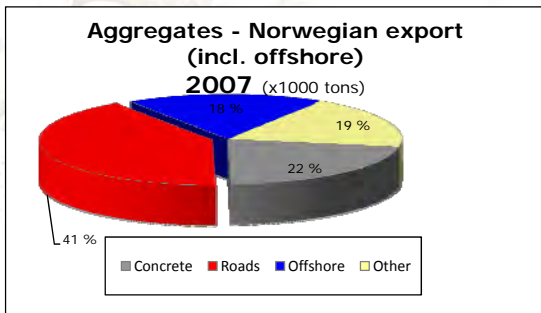

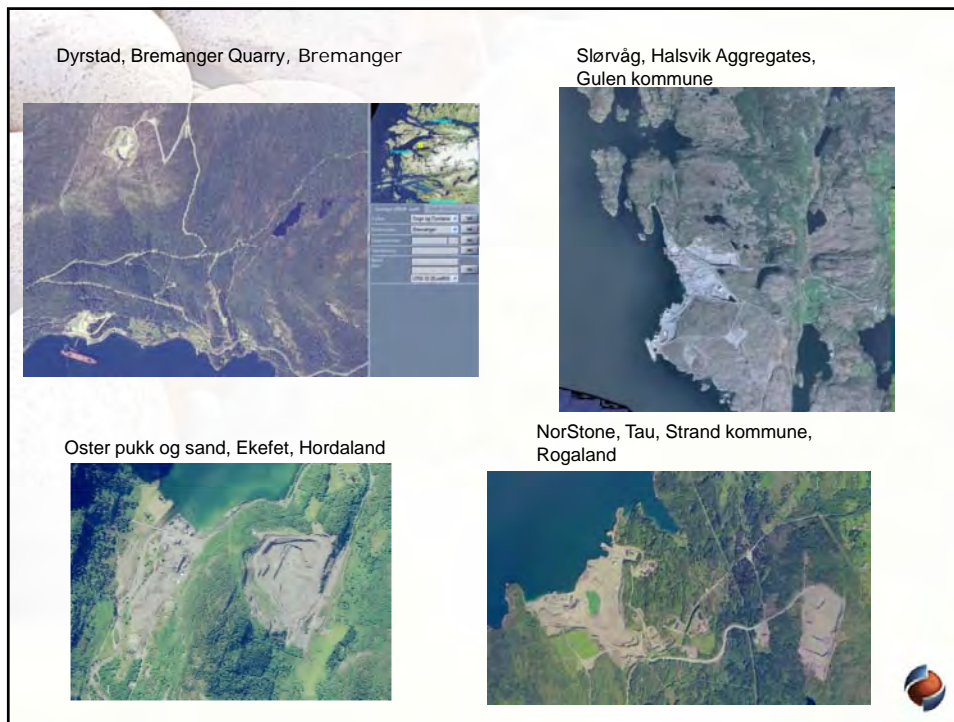



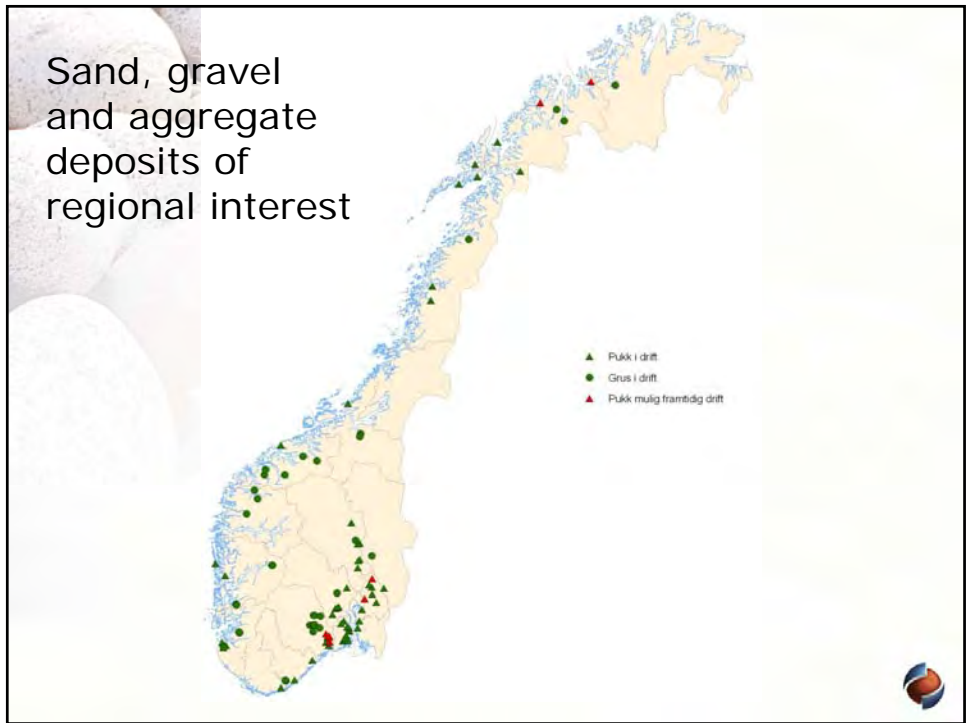
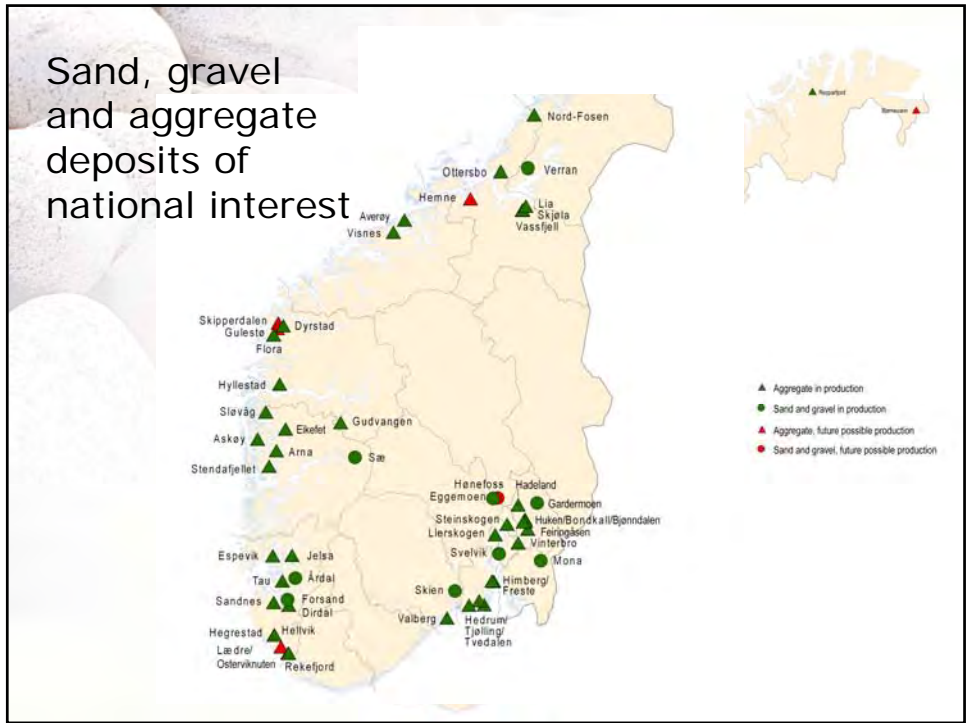

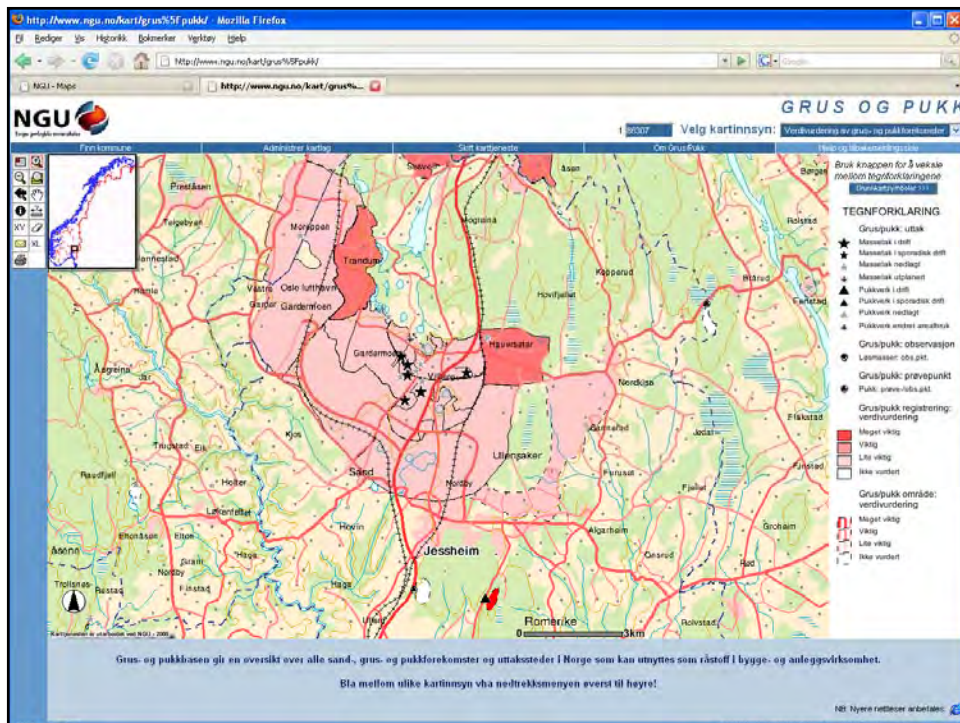
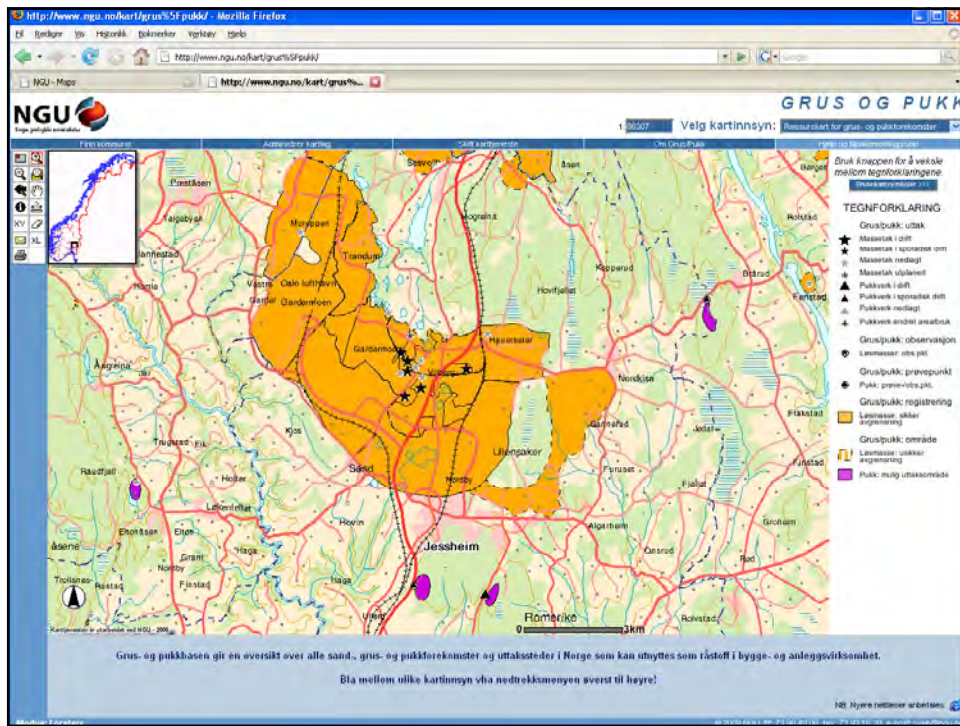

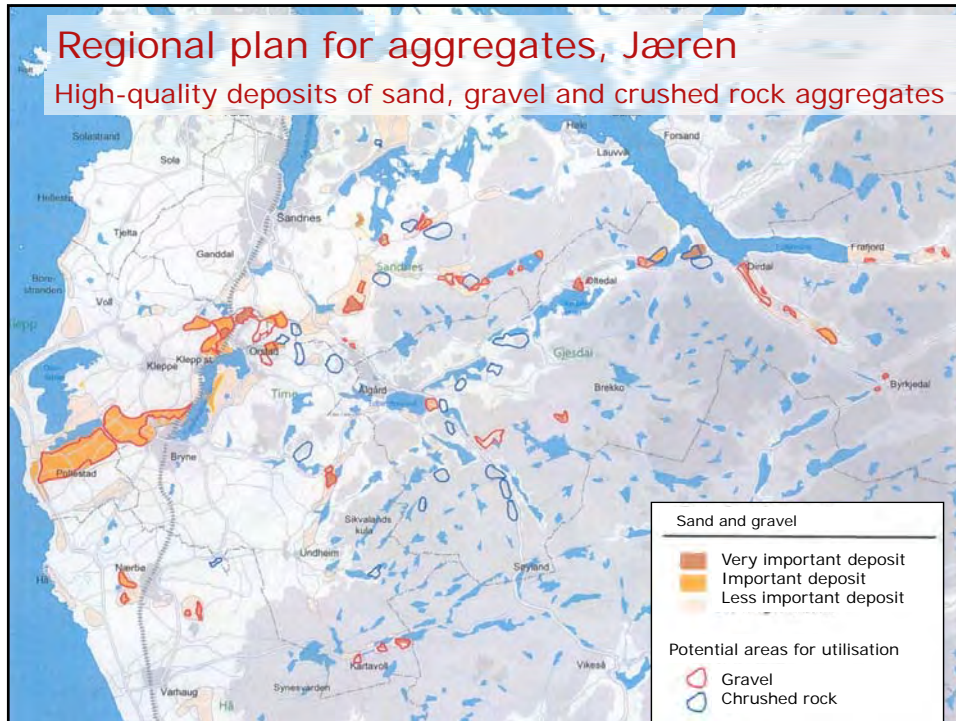

Case study: Espevik

- Annual production: 1.1 mill tonnes
- 80-90% export
- Reserves for 4-5 years
- Relocation and expansion plans: Sât

© Photo: Amrock

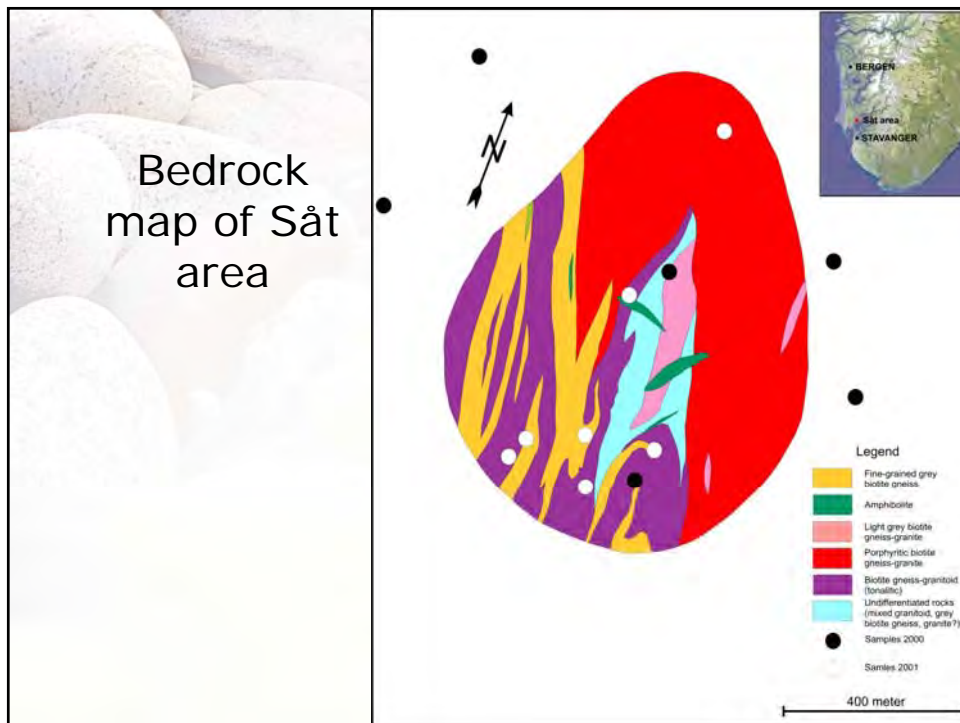
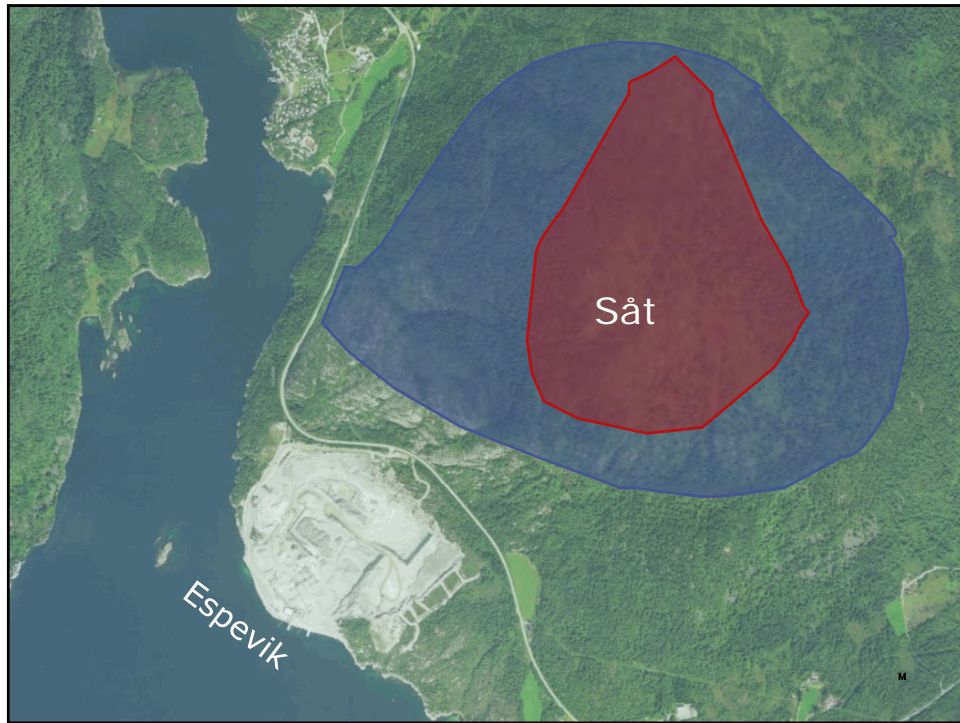

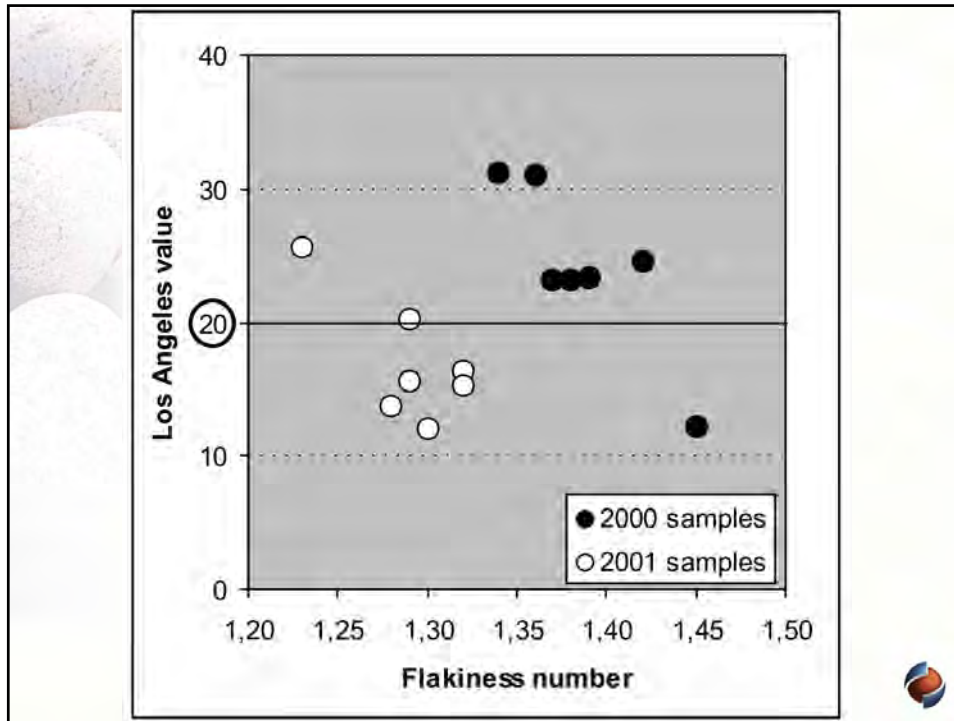

Competing land use interests

- NIMBY
- Urbanisation
- Conservation acts
- Tourism in unspoiled areas
- Sustainable management requires balanced land use planning.
- Land use planning requires unbiased information on resources.



Conclusions

- Aggregate industry has potential for further growth in Norway, if the actors meet the necessary environmental standards.
- Accept from community requires:
 - Geological knowledge: Where is the resource?
 - Transparency: Easy public access to information on mineral resources.
 - Holistic approach: Resource issues balanced against other types of land use.





THE CONCRETE DAM FØRREVASSDAMMEN

Odd Hotvedt

In Norway manufactured stone sand was used on a large scale for the construction of Førrevassdammen in the years 1982 – 1986. Førrevassdammen is double curved arch dam, 15 meter thick, with gravity dams at both sides. Maximum height is 96 m and the length is 1.300 meter. The concrete volume is 250.000 m³. The dam is situated at the high mountain at 1.000 meter above sea level in Rogaland country. It belongs to Statkraft Ulla-Førre-plant which is the biggest hydro power plant in Europe. By reason of the tough weather conditions at the construction site, the construction of the dam could only be executed at the summer months.

Not any natural aggregate resource was available close enough and all aggregate for the concrete production had to be produced at the site. Stone for the production of manufactured sand was taken out in a quarry close to the site. The rock was a gneiss-granite.

In addition to the concrete for the dam, there was also produced some 50.000 m³ of normal construction concrete for different use at the hydro power plant.

The production plant for the manufactured sand was based at three crushing steps. The final step was a horizontal impact crusher with horizontal shaft (Hazemag APK 1313). The separation was done in a wet process. The aggregate was split in the following fractions: 0,04 / 1 mm, 1 / 4 mm, 4 / 10 mm, 10 / 30 mm, 30 / 60 mm and 60 / 120 mm. The separation down to 4 mm was done by normal wet screening. The separation at 1 mm was done in a Rheax column and the separation at 0,04 mm was done by cyclones and lamella classifiers. The speed of the impact crusher was regulated between 30 and 55 meter per second in periphery speed to get balance in the volume of the fines gradings. High speed made high production of the finest grading, but also high consumption of wearing steel in the crushers. In general there was an overproduction of the grading 1 / 1 mm. This was a consequence of the mineral composition, the dominating crystal size etc in the rock.

The concrete for the dam was of two types. The concrete closer than 1,5 meter from the surface was a frost resistant surface concrete with d_{maks} 60 mm. The rest was an inner concrete with d_{maks} 120 mm. In the surface concrete there was 210 kg cement per m³ and in the inner concrete 150 kg, in addition to that 16 kg silica fumes for both. The cement contained 30% fly ash. The demand for characteristic strength of the surface concrete was 30 MPa and for the inner concrete 25 MPa.

The normal construction concrete that was made was a C30 quality with d_{maks} 22 mm and 325 kg cement per m³.

The experiences with the production and the use of this concrete can be summed up like this; to the object the concrete was used to, nothing important was different from what it had been with corresponding concrete produced from natural sand and gravel. More bad shape and texture was to a certain extent compensated by a very good control with the grading of the aggregate. The grading for the dam concrete was very similar to a Füller curve. For the grading for the normal construction concrete a curve with a particle step was used. A great deal of the construction concrete with d_{maks} 22 mm was pumped.

One negative experience was a tendency for bleeding of the fresh concrete. The fine aggregate had some to little of fines (filler) smaller than 0,06 mm. The aggregate separation plant could not be adjusted to increase the fines content enough without reconstruction and it was decided to live with this small problem in the construction period.

MANUFACTURED SAND



TWO CASES

- THE CONCRETE DAM "FØRREVASSDAMMEN" 1982-1986
- NORSK STEIN 1993

ODD HOTVEDT

FØRREVASSDAMMEN



FØRREVASSDAMMEN

- ARCH + GRAVIDITY DAM
- LENGTH: 1.300 m
- HEIGHT: 96 m
- VOLUME: 255.000 m³

NO NATURAL AGGREGATE AVAILABLE !



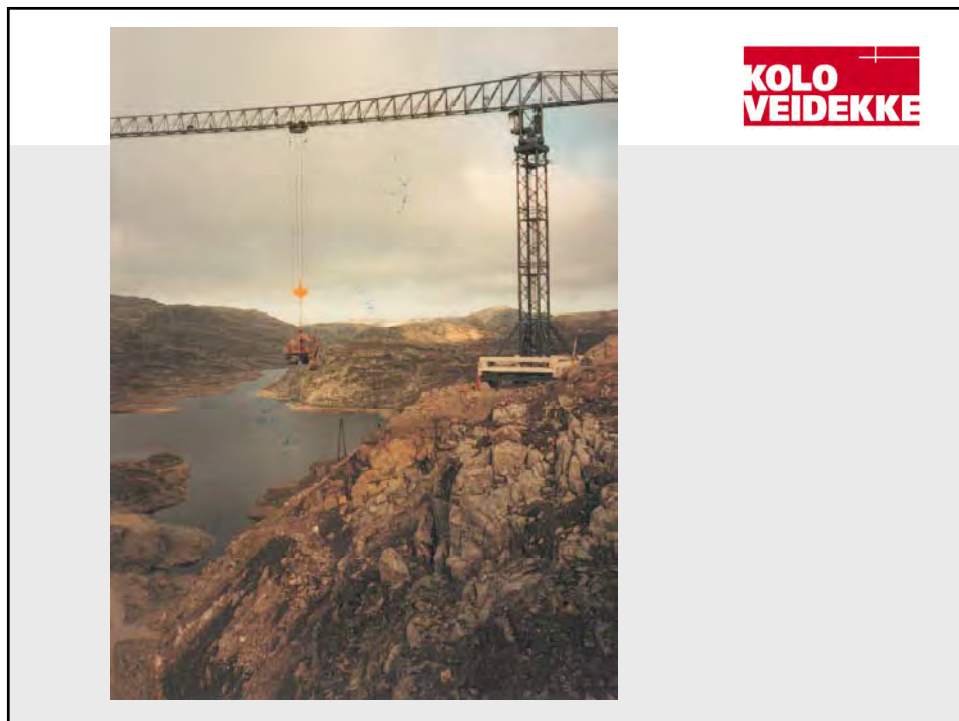

FØRREVASSDAMMEN



FØRREVASSDAMMEN



FØRREVASSDAMMEN



INNER CONCRETE

- $D_{\max} = 120$ mm
- 150 kg cement with 30% fly ash per m^3
- 16 kg silica fumes per m^3
- 25 MPa

SURFACE CONCRETE

- $D_{\max} = 60$ mm
- 210 kg cement with 30% fly ash per m^3
- 16 kg silica fumes per m^3
- 30 MPa

Crushed ice !

FØRREVASSDAMMEN



NORMAL CONSTRUCTION CONCRETE

- $D_{\max} = 22$ mm
- 325 kg cement per m^3
- 16 kg silica (?) fumes per m^3
- 30 MPa

50.000 m^3 , partial pumped

FØRREVASSDAMMEN



AGGREGATE PRODUCTION

- Rock: Gneiss-granite
- 3 crushing steps
- 3. step:
 - Horizontal impact crusher, Hazemag APK 1313
 - Periphery speed: 30 – 55 m/s

(Alternative was Cone crusher + Rod mill ?)

FØRREVASSDAMMEN



SEPARATION

6 fractions: **0,04 / 1 mm** (0,06 / 1 mm)

1 / 4 mm

4 / 10 mm

10 / 30 mm

30 / 60 mm

60 / 120 mm

Total concrete aggregate curve: “ Füller curve”

FØRREVASSDAMMEN



SEPARATION PROCESS

Wet process:

- Normal wet screening down to 4 mm cut
- Rheax column at 1 mm cut
- Cyclones + lamella classifiers at 0,04 mm cut

FØRREVASSDAMMEN



FØRREVASSDAMMEN



FØRREVASSDAMMEN





FØRREVASSDAMMEN

KOLO VEIDEKKE

EXPERIENCES

- **No particular by reason of manufactured sand !**
- **Some bleeding – some lack of fines in 0,04 – 1 mm**
- **Some over- production of 1 / 4 mm**
- **Much work and costs at the impact crusher (wearing parts - manganese). Alternatives included investment cost probably worse !**

FØRREVASSDAMMEN



FØRREVASSDAMMEN



FØRREVASSDAMMEN



FØRREVASSDAMMEN



MANUFACTURED SAND



NORSK STEIN 1993

Construction of new crushing plant with stock and berth facilities

Basis:

- Requirement for much concrete (2.000 m³ ?)
- Long distance to ready mixed plant (expensive !)
- Crushed material available (0/2, 2/5, 5/8, 8/11, 11/16, 16/22 mm)
- Knowledge and competence for concrete production available in the staff

NORSK STEIN 1993



Goal

- Produce concrete just good enough for the constructions, as simple and cheap as possible.

NORSK STEIN 1993



Aggregate

- Rock: Granodioritt / Gneiss-granite
- Gradings: 0/2, 2/5, 5/8, 8/11, 11/16, 16/22 mm
 - 0/2 was not washed or dry processed
 - Cone crushers in the final crushing step.
 - The shape of the fine fractions was not particular good

Concrete production plant:

- Very simple, silos for 3 gradings
- Production fully certificated

NORSK STEIN 1993



Best result for fresh concrete

D max= 22mm with step-gradings;

Step: 5 / 8 mm

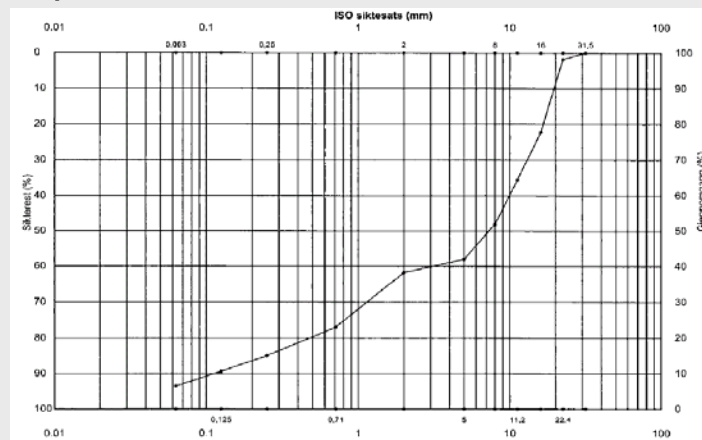

NORSK STEIN 1993



Typical recipes:

1. C25, $v/c < 0,90$, $d_{max} = 22$ mm
270 kg cement, Additive: 4 litre Plasticizer admixture (Perlamin P)
2. C35, $v/c < 0,60$, $d_{max} = 22$ mm
300 kg cement, Additive: 4 litre Superplasticizer admixture (Perlamin F)
3. C65, $v/c < 0,45$, $d_{max} = 22$ mm
425 kg cement, Additive: 4,5 litre Plasticizer + 4,5 litre Superplasticizer

■ It worked !

- The C65 – recipe gave tough consistence, but was workable
- No particular effort was necessary by pouring
- Pumping was not tried

Abstract

Metso presentations on manufactured sand at COIN workshop Stavanger Oct 30-31

Background:

Metso Minerals has been following the global trend of increasing use of manufactured sand in concrete for the past 10-15 years in order to develop machines and solutions that fit the market needs, Recommending the most cost effective solution for a given customer and application is a complex procedure with many aspects. We will highlight three important aspects in our presentations.

Presentations:

1. Example of how to evaluate shape of fine aggregate

In this presentation, Jouni Mahonen will give the background to the NZ flow cone and present results that indicate that the level of fines will have impact on results on flow time and void content of fine aggregate. These are important parameters for how the sand will perform in concrete

2. Barmac / HP sand Case in US

This presentation by Jarmo Eloranta will look at results from a recent test in USA where a Barmac VSI crusher and HP type cone crusher were compared in performance from different aspects. Aspects like yield of sand, power consumption, amount of fines produced and shape of the sand. Since there is no internationally recognized and widely used standard for evaluating shape, the NZ flow cone test method was used.

3. Air Classification. A method to to adjust fine aggregate gradation

Manufactured sand, especially sand with very good shape properties, have a higher level of fines (minus 125 micron) than what is required in most concrete mix designs.

The conventional way to reduce the amount of fines in fine aggregate has been by washing. In recent years however dry classification has entered the market as a strong alternative. Sven-Henrik Norman will present Metso's solution for air classification.

Conclusion:

The production technology for manufacturing sand/fine aggregate for concrete is more advanced than normal production of aggregates, but still incorporates the same basic crushing and screening equipment. With the addition of classification tools are available for production of high quality manufactured sand for concrete.

Metso Minerals would like to see development of test methods for fine aggregate. As an equipment and solutions provider, it is important to know more about the exact shape and gradation requirements of end users/concrete producers so that the right equipment recommendation can be made to the aggregate / sand producer.

Barmac / HP sand

Presentation for Stavanger Sand Meeting,
Oct.2008

Case in US

Tests run during May and August 2006

(Soft rock)



Jarmo Eloranta



Tests August 2006

- Feed material: Gravel: Crushability 56%, Abrasiveness 924 g/t
- HP cavity: fine
- Slotteed (penpendicular against material flow). Width 4,75, length abt 5x.

Test ID	Crusher	Feed	Speed*	CSS	Cascade	Rotor	Red. Ratio 80
A	B9100	5/8" x 0	60	NA	0%	3-port Std	1.30
B	B9100	5/8" x 0	55	NA	0%	3-port Std	1.20
C	B9100	5/8" x 0	65	NA	0%	3-port Std	1.28
D	HP100	5/8" x 0	870	0.44"	NA	NA	1.15
E	B9100	5/8" x 0	55	NA	0%	4-port Deep	1.34
F	B9100	5/8" x 0	60	NA	0%	4-port Deep	1.33
G	B9100	5/8" x 0	65	NA	0%	4-port Deep	1.44
H	HP100	5/8" x 0	1100	0.44"	NA	NA	1.13
I	HP100	5/8" x 0	1100	0.44"	NA	NA	1.18
J	HP100	5/8" x 0	1200	0.44"	NA	NA	1.15
K	HP100	5/8" x 0	1100	0.38"	NA	NA	1.27
L	B9100	1" x 1/4"	55	NA	0%	4-port Deep	1.44
M	B9100	1" x 1/4"	60	NA	0%	4-port Deep	1.79
N	B9100	1" x 1/4"	65	NA	0%	4-port Deep	1.47
O	HP100	1" x 1/4"	1100	0.38"	NA	NA	1.60
P	HP100	1" x 1/4"	1200	0.38"	NA	NA	1.31
Q	HP100	1" x 1/4"	1000	0.38"	NA	NA	1.55
R	HP100	1" x 1/4"	1100	0.44"	NA	NA	1.29
S	B9100	1" x 1/4"	55	NA	0%	3-port Deep	1.56
T	B9100	1" x 1/4"	60	NA	0%	3-port Deep	1.30
U	B9100	1" x 1/4"	65	NA	0%	3-port Deep	1.43
V	B9100	1" x 1/4"	60	NA	10%	3-port Deep	NA
W	B9100	1" x 1/4"	60	NA	20%	3-port Deep	1.56
X	HP100	3/8" x 1/8"	1100	0.48"	NA	NA	1.07
Y	HP100	3/8" x 1/8"	1100	0.44"	NA	NA	1.10
Z	HP100	3/8" x 1/8"	1200	0.44"	NA	NA	1.09
AA	HP100	3/8" x 1/8"	1100	0.38"	NA	NA	1.16
BB	B9100	3/8" x 1/8"	60	NA	0%	3-port Deep	1.20
CC	B9100	5/8" x 0	55	NA	0%	3-port Deep	1.41
DD	B9100	5/8" x 0	60	NA	0%	3-port Deep	1.40
EE	B9100	5/8" x 0	65	NA	0%	3 port Deep	1.32

Flow sheet

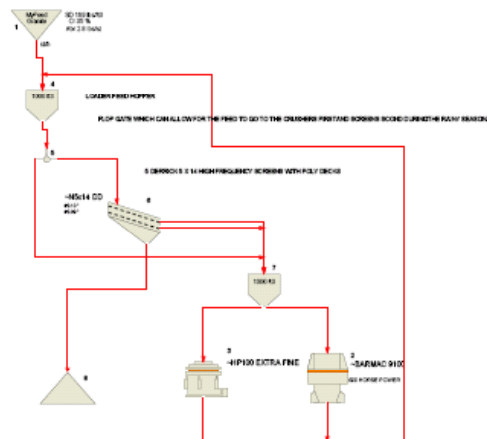

*Speed: B9100 is in m/s tip speed. HP100 is in rpm countershaft speed.

B9100 tests in BLUE

HP100 tests in BLACK

Tests in GREEN do not include one sample gradation



Feed

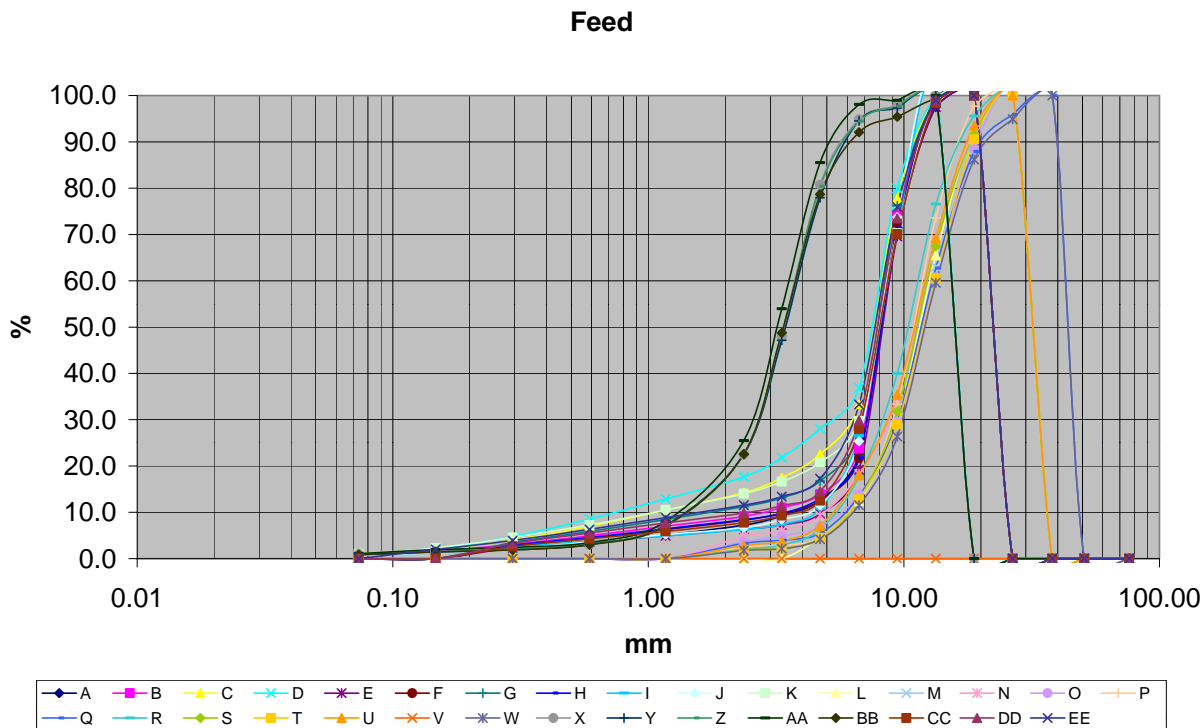

Product

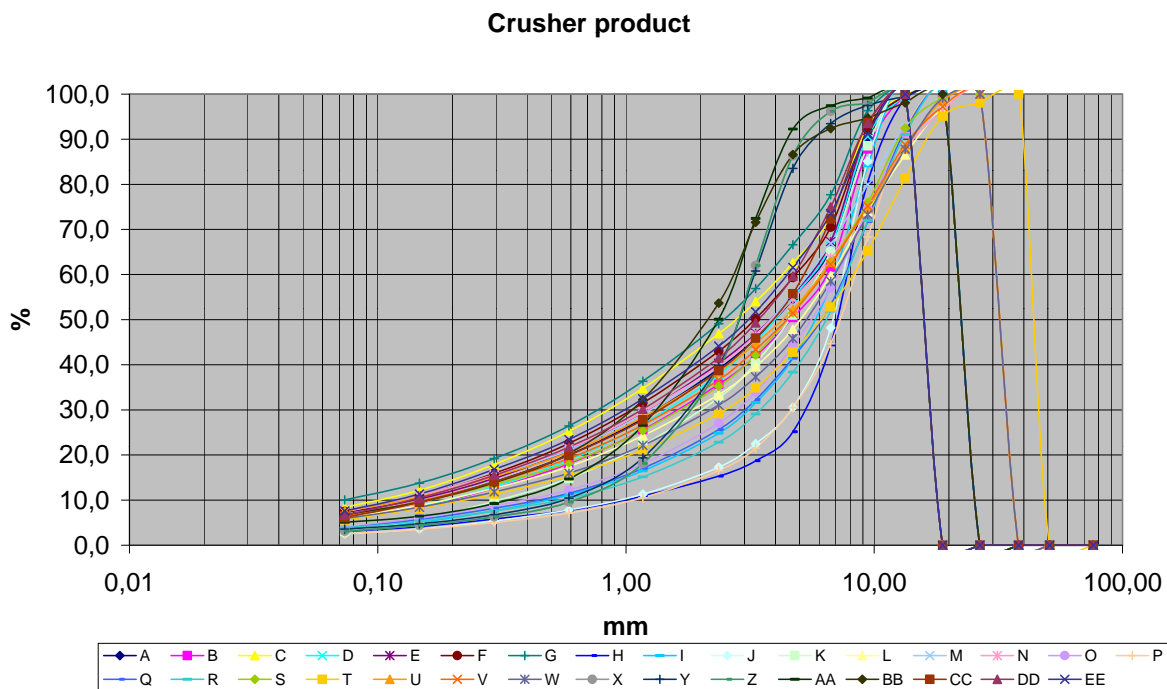

Summary of valid test results

(sand amount calculated from screen undersize)
Production of ASTM C33 Spec Sand

Crusher	Test	Oper. HP	Screen Undersize (STPH)	HP/Ton Screen Undersize	% Coarse Waste	%C33 Sand	% Fine Waste	STPH of C33 Sand	HP/Ton of C33 Sand	Bruno Screen Setup	Feed	Speed*	CSS (in)	Cascade	Rotor	RR 80	aver flow time (s)	% voids	ASTM % voids
											5/8" x 0	60	NA	0%	3-p Std.	1.30	25.5	38.7	43.6
B9100	A	490	158.6	3.09	27%	61%	12%	96.7	5.06	A	5/8" x 0	60	NA	0%	3-p Std.	1.20	26.1	38.3	44.0
B9100	B	490	171.8	2.85	29%	60%	11%	103.1	4.75	A	5/8" x 0	55	NA	0%	3-p Std.	1.28	25.4	37.8	43.5
B9100	C	500	158.4	3.16	25%	62%	13%	98.2	5.09	A	5/8" x 0	65	NA	0%	4-p Deep	1.34	25.4	38.6	46.5
B9100	E	495	184.4	2.68	29%	60%	11%	110.6	4.47	A	5/8" x 0	60	NA	0%	4-p Deep	1.33	25.5	38.2	44.3
B9100	F	495	176.9	2.80	26%	62%	11%	109.7	4.51	A	5/8" x 0	60	NA	0%	4-p Deep	1.33	25.5	38.2	44.3
HP100	H	57	30.8	1.85	49%	44%	7%	13.6	4.21	B	5/8" x 0	1100	0.44"	NA	NA	1.13	28.2	41.5	43.8
HP100	I	69	44	1.57	57%	36%	6%	15.8	4.36	C	5/8" x 0	1100	0.44"	NA	NA	1.18	*	*	44.7
HP100	J	51	30.6	1.67	44%	49%	7%	15.0	3.40	B	5/8" x 0	1200	0.44"	NA	NA	1.15	29.3	41.7	45.1
B9100	L	490	145.9	3.36	26%	63%	12%	91.9	5.33	A	1" x 1/4"	55	NA	0%	4-p Deep	1.44	27.3	38.3	44.7
B9100	M	490	138.5	3.54	26%	62%	12%	85.9	5.71	A	1" x 1/4"	60	NA	0%	4-p Deep	1.79	27.2	38.3	44.0
B9100	N	495	129.8	3.81	24%	63%	14%	81.8	6.05	A	1" x 1/4"	65	NA	0%	4-p Deep	1.47	24.7	38.0	43.1
HP100	O	87	47.3	1.84	40%	51%	9%	24.1	3.61	B	1" x 1/4"	1100	0.38"	NA	NA	1.60	28.2	41.8	46.8
HP100	P	56	29.4	1.90	51%	41%	8%	12.1	4.65	B	1" x 1/4"	1200	0.38"	NA	NA	1.31	28.2	41.8	45.9
HP100	Q	111	46	2.41	41%	50%	8%	23.0	4.83	B	1" x 1/4"	1000	0.38"	NA	NA	1.55	29.1	41.8	46.6
HP100	R	83	36.3	2.29	51%	40%	9%	14.5	5.72	C	1" x 1/4"	1100	0.44"	NA	NA	1.29	30.5	42.1	47.4
B9100	S	505	145.7	3.47	29%	60%	11%	87.4	5.78	A	1" x 1/4"	55	NA	0%	3-p Deep	1.56	25.2	38.0	44.6
B9100	T	500	136.9	3.65	25%	63%	12%	86.2	5.80	A	1" x 1/4"	60	NA	0%	3-p Deep	1.30	25.8	38.0	44.8
B9100	U	500	141.4	3.54	22%	66%	12%	93.3	5.36	A	1" x 1/4"	65	NA	0%	3-p Deep	1.43	25.5	37.8	44.0
B9100	V	495	150.4	3.29	28%	61%	12%	91.7	5.40	A	1" x 1/4"	60	NA	10%	3-p Deep	NA	26.2	37.9	43.7
B9100	W	498	158.1	3.15	27%	61%	12%	96.4	5.16	A	1" x 1/4"	60	NA	20%	3-p Deep	1.56	26.3	38.4	45.1
HP100	X	63	90.9	0.69	76%	20%	4%	18.2	3.47	D	3/8" x 1/8"	1100	0.48"	NA	NA	1.07	33.6	39.5	43.6
HP100	Y	83	89.5	0.93	71%	24%	4%	21.5	3.86	D	3/8" x 1/8"	1100	0.44"	NA	NA	1.10	31	40.0	44.2
HP100	Z	63	82.7	0.76	74%	22%	3%	18.2	3.46	D	3/8" x 1/8"	1200	0.44"	NA	NA	1.09	33.7	39.7	44.3
HP100	AA	111	82.7	1.34	67%	27%	6%	22.3	4.97	D	3/8" x 1/8"	1100	0.38"	NA	NA	1.16	27.4	40.2	45.1
B9100	BB	500	275.1	1.82	44%	49%	7%	134.8	3.71	E	3/8" x 1/8"	60	NA	0%	3-p Deep	1.20	25.7	39.0	44.8
B9100	DD	500	172.9	2.89	26%	63%	11%	108.9	4.59	A	5/8" x 0	60	NA	0%	3-p Deep	1.40	24.2	38.3	44.5
B9100	EE	500	163.2	3.06	25%	64%	12%	104.4	4.79	A	5/8" x 0	65	NA	0%	3-p Deep	1.32	24	37.5	44.0

*C33 production values taken from running screen undersize gradation through Bruno with a screen setup to produce a sand within the specification ASTM C33 man. Sand. 100% screen efficiency was used. Gate used on mid-deck of C,D,E setups. Horsepower for HP tests are calculated from amps observed and motor efficiency curves for 125 hp WEG motor.

In next pages this data sorted according to different criteria and graphs are drawn

Bruno Screen Setup				
	Top Deck	Middle Deck	Bottom Deck	%Mid-Deck
A	0.111"	NA	0.0029"	NA
B	0.093"	NA	0.0029"	NA
C	0.093"	0.0234"	0.0029"	25 %
D	0.093"	0.0234"	0.0029"	65 %
E	0.111"	0.0234"	0.0029"	35 %

See last slide in presentation



Sand production %

Production of ASTM C33 Spec Sand

Crusher	Test	Oper. HP	Screen Undersize (STPH)	HP/Ton Screen Undersize	% Coarse Waste	%C33 Sand	% Fine Waste	STPH of C33 Sand	HP/Ton of C33 Sand	Feed	Speed*	CSS (in)	Cascade	Rotor	RR 80	aver flow time (s)	% voids	ASTM % voids
										1" x 1/4"	65	NA	0%	3-p Deep <th>1.43</th> <th>25.5</th> <th>37.8</th> <th>44.0</th>	1.43	25.5	37.8	44.0
B9100	U	500	141.4	3.54	22%	66%	12%	93.3	5.36	5/8" x 0	65	NA	0%	3-p Deep	1.32	24	37.5	44.0
B9100	EE	500	163.2	3.06	25%	64%	12%	104.4	4.79	1" x 1/4"	55	NA	0%	4-p Deep	1.44	27.3	38.3	44.7
B9100	L	490	145.9	3.36	26%	63%	12%	91.9	5.33	1" x 1/4"	65	NA	0%	4-p Deep	1.47	24.7	38.0	43.1
B9100	N	495	129.8	3.81	24%	63%	14%	81.8	6.05	1" x 1/4"	60	NA	0%	3-p Deep	1.30	25.8	38.0	44.8
B9100	T	500	136.9	3.65	25%	63%	12%	86.2	5.80	5/8" x 0	60	NA	0%	3-p Deep	1.40	24.2	38.3	44.5
B9100	DD	500	172.9	2.89	26%	63%	11%	108.9	4.59	5/8" x 0	65	NA	0%	3-p Std.	1.28	25.4	37.8	43.5
B9100	C	500	158.4	3.16	25%	62%	13%	98.2	5.09	5/8" x 0	60	NA	0%	4-p Deep	1.33	25.5	38.2	44.3
B9100	F	495	176.9	2.80	26%	62%	11%	109.7	4.51	1" x 1/4"	60	NA	0%	4-p Deep	1.79	27.2	38.3	44.0
B9100	M	490	138.5	3.54	26%	62%	12%	85.9	5.71	5/8" x 0	60	NA	0%	3-p Std.	1.30	25.5	38.7	43.6
B9100	A	490	158.6	3.09	27%	61%	12%	96.7	5.06	1" x 1/4"	60	NA	10%	3-p Deep	NA	26.2	37.9	43.7
B9100	V	495	150.4	3.29	28%	61%	12%	91.7	5.40	1" x 1/4"	60	NA	20%	3-p Deep	1.56	26.3	38.4	45.1
B9100	W	498	158.1	3.15	27%	61%	12%	96.4	5.16	1" x 1/4"	55	NA	0%	3-p Deep	1.20	26.1	38.3	44.0
B9100	B	490	171.8	2.85	29%	60%	11%	103.1	4.75	5/8" x 0	55	NA	0%	3-p Std.	1.20	26.1	38.3	44.0
B9100	E	495	184.4	2.68	29%	60%	11%	110.6	4.47	5/8" x 0	55	NA	0%	4-p Deep	1.34	25.4	38.6	46.5
B9100	S	505	145.7	3.47	29%	60%	11%	87.4	5.78	1" x 1/4"	55	NA	0%	3-p Deep	1.56	25.2	38.0	44.6
HP100	O	87	47.3	1.84	40%	51%	9%	24.1	3.61	1" x 1/4"	1100	0.38"	NA	NA	1.60	28.2	41.8	46.8
HP100	Q	111	46	2.41	41%	50%	8%	23.0	4.83	1" x 1/4"	1000	0.38"	NA	NA	1.55	29.1	41.8	46.6
HP100	J	51	30.6	1.67	44%	49%	7%	15.0	3.40	5/8" x 0	1200	0.44"	NA	NA	1.15	29.3	41.7	45.1
B9100	BB	500	275.1	1.82	44%	49%	7%	134.8	3.71	3/8" x 1/8"	60	NA	0%	3-p Deep	1.20	25.7	39.0	44.8
HP100	H	57	30.8	1.85	49%	44%	7%	13.6	4.21	5/8" x 0	1100	0.44"	NA	NA	1.13	28.2	41.5	43.8
HP100	P	56	29.4	1.90	51%	41%	8%	12.1	4.65	1" x 1/4"	1200	0.38"	NA	NA	1.31	28.2	41.8	45.9
HP100	R	83	36.3	2.29	51%	40%	9%	14.5	5.72	1" x 1/4"	1100	0.44"	NA	NA	1.29	30.5	42.1	47.4
HP100	I	69	44	1.57	57%	36%	6%	15.8	4.36	5/8" x 0	1100	0.44"	NA	NA	1.18	*	*	44.7
HP100	AA	111	82.7	1.34	67%	27%	6%	22.3	4.97	3/8" x 1/8"	1100	0.38"	NA	NA	1.16	27.4	40.2	45.1
HP100	Y	83	89.5	0.93	71%	24%	4%	21.5	3.86	3/8" x 1/8"	1100	0.44"	NA	NA	1.10	31	40.0	44.2
HP100	Z	63	82.7	0.76	74%	22%	3%	18.2	3.46	3/8" x 1/8"	1200	0.44"	NA	NA	1.09	33.7	39.7	44.3
HP100	X	63	90.9	0.69	76%	20%	4%	18.2	3.47	3/8" x 1/8"	1100	0.48"	NA	NA	1.07	33.6	39.5	43.6

• Barmac gives higher yield for sand

$$\text{STPH of C33 Sand} = \frac{\text{Screen undersize STPH}}{\dots}$$



HP / ton of sand

Production of ASTM C33 Spec Sand

Crusher	Test	Oper. HP	Screen Undersize (STPH)	HP/Ton Screen Undersize	% Coarse Waste	%C33 Sand	% Fine Waste	STPH of C33 Sand	HP/Ton of C33 Sand	Feed	Speed*	CSS (in)	Cascade	Rotor	RR 80	aver flow time (s)	% voids	ASTM % voids
HP100	J	51	30.6	1.67	44%	49%	7%	15.0	3.40	5/8" x 0	1200	0.44"	NA	NA	1.15	29.3	41.7	45.1
HP100	Z	63	82.7	0.76	74%	22%	3%	18.2	3.46	3/8" x 1/8"	1200	0.44"	NA	NA	1.09	33.7	39.7	44.3
HP100	X	63	90.9	0.69	76%	20%	4%	18.2	3.47	3/8" x 1/8"	1100	0.48"	NA	NA	1.07	33.6	39.5	43.6
HP100	O	87	47.3	1.84	40%	51%	9%	24.1	3.61	1" x 1/4"	1100	0.38"	NA	NA	1.60	28.2	41.8	46.8
B9100	BB	500	275.1	1.82	44%	49%	7%	134.8	3.71	3/8" x 1/8"	60	NA	0%	3-p Deep	1.20	25.7	39.0	44.8
HP100	Y	83	89.5	0.93	71%	24%	4%	21.5	3.86	3/8" x 1/8"	1100	0.44"	NA	NA	1.10	31	40.0	44.2
HP100	H	57	30.8	1.85	49%	44%	7%	13.6	4.21	5/8" x 0	1100	0.44"	NA	NA	1.13	28.2	41.5	43.8
HP100	I	69	44	1.57	57%	36%	6%	15.8	4.36	5/8" x 0	1100	0.44"	NA	NA	1.18	*	*	44.7
B9100	E	495	184.4	2.68	29%	60%	11%	110.6	4.47	5/8" x 0	55	NA	0%	4-p Deep	1.34	25.4	38.6	46.5
B9100	F	495	176.9	2.80	26%	62%	11%	109.7	4.51	5/8" x 0	60	NA	0%	4-p Deep	1.33	25.5	38.2	44.3
B9100	DD	500	172.9	2.89	26%	63%	11%	108.9	4.59	5/8" x 0	60	NA	0%	3-p Deep	1.40	24.2	38.3	44.5
HP100	P	56	29.4	1.90	51%	41%	8%	12.1	4.65	1" x 1/4"	1200	0.38"	NA	NA	1.31	28.2	41.8	45.9
B9100	B	490	171.8	2.85	29%	60%	11%	103.1	4.75	5/8" x 0	55	NA	0%	3-p Std.	1.20	26.1	38.3	44.0
B9100	EE	500	163.2	3.06	25%	64%	12%	104.4	4.79	5/8" x 0	65	NA	0%	3-p Deep	1.32	24	37.5	44.0
HP100	Q	111	46	2.41	41%	50%	8%	23.0	4.83	1" x 1/4"	1000	0.38"	NA	NA	1.55	29.1	41.8	46.6
HP100	AA	111	82.7	1.34	67%	27%	6%	22.3	4.97	3/8" x 1/8"	1100	0.38"	NA	NA	1.16	27.4	40.2	45.1
B9100	A	490	158.6	3.09	27%	61%	12%	96.7	5.06	5/8" x 0	60	NA	0%	3-p Std.	1.30	25.5	38.7	43.6
B9100	C	500	158.4	3.16	25%	62%	13%	98.2	5.09	5/8" x 0	65	NA	0%	3-p Std.	1.28	25.4	37.8	43.5
B9100	W	498	158.1	3.15	27%	61%	12%	96.4	5.16	1" x 1/4"	60	NA	20%	3-p Deep	1.56	26.3	38.4	45.1
B9100	L	490	145.9	3.36	26%	63%	12%	91.9	5.33	1" x 1/4"	55	NA	0%	4-p Deep	1.44	27.3	38.3	44.7
B9100	U	500	141.4	3.54	22%	66%	12%	93.3	5.36	1" x 1/4"	65	NA	0%	3-p Deep	1.43	25.5	37.8	44.0
B9100	V	495	150.4	3.29	28%	61%	12%	91.7	5.40	1" x 1/4"	60	NA	10%	3-p Deep	NA	26.2	37.9	43.7
B9100	M	490	138.5	3.54	26%	62%	12%	85.9	5.71	1" x 1/4"	60	NA	0%	4-p Deep	1.79	27.2	38.3	44.0
HP100	R	83	36.3	2.29	51%	40%	9%	14.5	5.72	1" x 1/4"	1100	0.44"	NA	NA	1.29	30.5	42.1	47.4
B9100	S	505	145.7	3.47	29%	60%	11%	87.4	5.78	1" x 1/4"	55	NA	0%	3-p Deep	1.56	25.2	38.0	44.6
B9100	T	500	136.9	3.65	25%	63%	12%	86.2	5.80	1" x 1/4"	60	NA	0%	3-p Deep	1.30	25.8	38.0	44.8
B9100	N	495	129.8	3.81	24%	63%	14%	81.8	6.05	1" x 1/4"	65	NA	0%	4-p Deep	1.47	24.7	38.0	43.1

- HP uses less energy/produced sand ton



Fine waste %

Production of ASTM C33 Spec Sand

Crusher	Test	Oper. HP	Screen Undersize (STPH)	HP/Ton Screen Undersize	% Coarse Waste	%C33 Sand	% Fine Waste	STPH of C33 Sand	HP/Ton of C33 Sand	Feed	Speed*	CSS (in)	Cascade	Rotor	RR 80	aver flow time (s)	% voids	ASTM % voids
HP100	Z	63	82.7	0.76	74%	22%	3%	18.2	3.46	3/8" x 1/8"	1200	0.44"	NA	NA	1.09	33.7	39.7	44.3
HP100	X	63	90.9	0.69	76%	20%	4%	18.2	3.47	3/8" x 1/8"	1100	0.48"	NA	NA	1.07	33.6	39.5	43.6
HP100	Y	83	89.5	0.93	71%	24%	4%	21.5	3.86	3/8" x 1/8"	1100	0.44"	NA	NA	1.10	31	40.0	44.2
HP100	I	69	44	1.57	57%	36%	6%	15.8	4.36	5/8" x 0	1100	0.44"	NA	NA	1.18	*	*	44.7
HP100	AA	111	82.7	1.34	67%	27%	6%	22.3	4.97	3/8" x 1/8"	1100	0.38"	NA	NA	1.16	27.4	40.2	45.1
HP100	H	57	30.8	1.85	49%	44%	7%	13.6	4.21	5/8" x 0	1100	0.44"	NA	NA	1.13	28.2	41.5	43.8
HP100	J	51	30.6	1.67	44%	49%	7%	15.0	3.40	5/8" x 0	1200	0.44"	NA	NA	1.15	29.3	41.7	45.1
B9100	BB	500	275.1	1.82	44%	49%	7%	134.8	3.71	3/8" x 1/8"	60	NA	0%	3-p Deep	1.20	25.7	39.0	44.8
HP100	P	56	29.4	1.90	51%	41%	8%	12.1	4.65	1" x 1/4"	1200	0.38"	NA	NA	1.31	28.2	41.8	45.9
HP100	Q	111	46	2.41	41%	50%	8%	23.0	4.83	1" x 1/4"	1000	0.38"	NA	NA	1.55	29.1	41.8	46.6
HP100	O	87	47.3	1.84	40%	51%	9%	24.1	3.61	1" x 1/4"	1100	0.38"	NA	NA	1.60	28.2	41.8	46.8
HP100	R	83	36.3	2.29	51%	40%	9%	14.5	5.72	1" x 1/4"	1100	0.44"	NA	NA	1.29	30.5	42.1	47.4
B9100	B	490	171.8	2.85	29%	60%	11%	103.1	4.75	5/8" x 0	55	NA	0%	3-p Std.	1.20	26.1	38.3	44.0
B9100	E	495	184.4	2.68	29%	60%	11%	110.6	4.47	5/8" x 0	55	NA	0%	4-p Deep	1.34	25.4	38.6	46.5
B9100	F	495	176.9	2.80	26%	62%	11%	109.7	4.51	5/8" x 0	60	NA	0%	4-p Deep	1.33	25.5	38.2	44.3
B9100	S	505	145.7	3.47	29%	60%	11%	87.4	5.78	1" x 1/4"	55	NA	0%	3-p Deep	1.56	25.2	38.0	44.6
B9100	DD	500	172.9	2.89	26%	63%	11%	108.9	4.59	5/8" x 0	60	NA	0%	3-p Deep	1.40	24.2	38.3	44.5
B9100	A	490	158.6	3.09	27%	61%	12%	96.7	5.06	5/8" x 0	60	NA	0%	3-p Std.	1.30	25.5	38.7	43.6
B9100	L	490	145.9	3.36	26%	63%	12%	91.9	5.33	1" x 1/4"	55	NA	0%	4-p Deep	1.44	27.3	38.3	44.7
B9100	M	490	138.5	3.54	26%	62%	12%	85.9	5.71	1" x 1/4"	60	NA	0%	4-p Deep	1.79	27.2	38.3	44.0
B9100	T	500	136.9	3.65	25%	63%	12%	86.2	5.80	1" x 1/4"	60	NA	0%	3-p Deep	1.30	25.8	38.0	44.8
B9100	U	500	141.4	3.54	22%	66%	12%	93.3	5.36	1" x 1/4"	65	NA	0%	3-p Deep	1.43	25.5	37.8	44.0
B9100	V	495	150.4	3.29	28%	61%	12%	91.7	5.40	1" x 1/4"	60	NA	10%	3-p Deep	NA	26.2	37.9	43.7
B9100	W	498	158.1	3.15	27%	61%	12%	96.4	5.16	1" x 1/4"	60	NA	20%	3-p Deep	1.56	26.3	38.4	45.1
B9100	EE	500	163.2	3.06	25%	64%	12%	104.4	4.79	5/8" x 0	65	NA	0%	3-p Deep	1.32	24	37.5	44.0
B9100	C	500	158.4	3.16	25%	62%	13%	98.2	5.09	5/8" x 0	65	NA	0%	3-p Std.	1.28	25.4	37.8	43.5
B9100	N	495	129.8	3.81	24%	63%	14%	81.8	6.05	1" x 1/4"	65	NA	0%	4-p Deep	1.47	24.7	38.0	43.1

- Share of fines (<0.07mm = 0.0029in) is less with HP



Coarse waste %

Production of ASTM C33 Spec Sand

Crusher	Test	Oper. HP	Screen Undersize (STPH)	HP/Ton Screen Undersize	% Coarse Waste	%C33 Sand	% Fine Waste	STPH of C33 Sand	HP/Ton of C33 Sand	Bruno Screen Setup	Feed	Speed*	CSS (in)	Cascade	Rotor	RR 80	aver flow time (s)	% voids	ASTM % voids
B9100	U	500	141.4	3.54	22%	66%	12%	93.3	5.36	A	1" x 1/4"	65	NA	0%	3-p Deep	1.43	25.5	37.8	44.0
B9100	N	495	129.8	3.81	24%	63%	14%	81.8	6.05	A	1" x 1/4"	65	NA	0%	4-p Deep	1.47	24.7	38.0	43.1
B9100	C	500	158.4	3.16	25%	62%	13%	98.2	5.09	A	5/8" x 0	65	NA	0%	3-p Std.	1.28	25.4	37.8	43.5
B9100	T	500	136.9	3.65	25%	63%	12%	86.2	5.80	A	1" x 1/4"	60	NA	0%	3-p Deep	1.30	25.8	38.0	44.8
B9100	EE	500	163.2	3.06	25%	64%	12%	104.4	4.79	A	5/8" x 0	65	NA	0%	3-p Deep	1.32	24	37.5	44.0
B9100	F	495	176.9	2.80	26%	62%	11%	109.7	4.51	A	5/8" x 0	60	NA	0%	4-p Deep	1.33	25.5	38.2	44.3
B9100	L	490	145.9	3.36	26%	63%	12%	91.9	5.33	A	1" x 1/4"	55	NA	0%	4-p Deep	1.44	27.3	38.3	44.7
B9100	M	490	138.5	3.54	26%	62%	12%	85.9	5.71	A	1" x 1/4"	60	NA	0%	4-p Deep	1.79	27.2	38.3	44.0
B9100	DD	500	172.9	2.89	26%	63%	11%	108.9	4.59	A	5/8" x 0	60	NA	0%	3-p Deep	1.40	24.2	38.3	44.5
B9100	A	490	158.6	3.09	27%	61%	12%	96.7	5.06	A	5/8" x 0	60	NA	0%	3-p Std.	1.30	25.5	38.7	43.6
B9100	W	498	158.1	3.15	27%	61%	12%	96.4	5.16	A	1" x 1/4"	60	NA	20%	3-p Deep	1.56	26.3	38.4	45.1
B9100	V	495	150.4	3.29	28%	61%	12%	91.7	5.40	A	1" x 1/4"	60	NA	10%	3-p Deep	NA	26.2	37.9	43.7
B9100	B	490	171.8	2.85	29%	60%	11%	103.1	4.75	A	5/8" x 0	55	NA	0%	3-p Std.	1.20	26.1	38.3	44.0
B9100	E	495	184.4	2.68	29%	60%	11%	110.6	4.47	A	5/8" x 0	55	NA	0%	4-p Deep	1.34	25.4	38.6	46.5
B9100	S	505	145.7	3.47	29%	60%	11%	87.4	5.78	A	1" x 1/4"	55	NA	0%	3-p Deep	1.56	25.2	38.0	44.6
HP100	O	87	47.3	1.84	40%	51%	9%	24.1	3.61	B	1" x 1/4"	1100	0.38"	NA	NA	1.60	28.2	41.8	46.8
HP100	Q	111	46	2.41	41%	50%	8%	23.0	4.83	B	1" x 1/4"	1000	0.38"	NA	NA	1.55	29.1	41.8	46.6
HP100	J	51	30.6	1.67	44%	49%	7%	15.0	3.40	B	5/8" x 0	1200	0.44"	NA	NA	1.15	29.3	41.7	45.1
B9100	BB	500	275.1	1.82	44%	49%	7%	134.8	3.71	E	3/8" x 1/8"	60	NA	0%	3-p Deep	1.20	25.7	39.0	44.8
HP100	H	57	30.8	1.85	49%	44%	7%	13.6	4.21	B	5/8" x 0	1100	0.44"	NA	NA	1.13	28.2	41.5	43.8
HP100	P	56	29.4	1.90	51%	41%	8%	12.1	4.65	B	1" x 1/4"	1200	0.38"	NA	NA	1.31	28.2	41.8	45.9
HP100	R	83	36.3	2.29	51%	40%	9%	14.5	5.72	C	1" x 1/4"	1100	0.44"	NA	NA	1.29	30.5	42.1	47.4
HP100	I	69	44	1.57	57%	36%	6%	15.8	4.36	C	5/8" x 0	1100	0.44"	NA	NA	1.18	*	*	44.7
HP100	AA	111	82.7	1.34	67%	27%	6%	22.3	4.97	D	3/8" x 1/8"	1100	0.38"	NA	NA	1.16	27.4	40.2	45.1
HP100	Y	83	89.5	0.93	71%	24%	4%	21.5	3.86	D	3/8" x 1/8"	1100	0.44"	NA	NA	1.10	31	40.0	44.2
HP100	Z	63	82.7	0.76	74%	22%	3%	18.2	3.46	D	3/8" x 1/8"	1200	0.44"	NA	NA	1.09	33.7	39.7	44.3
HP100	X	63	90.9	0.69	76%	20%	4%	18.2	3.47	D	3/8" x 1/8"	1100	0.48"	NA	NA	1.07	33.6	39.5	43.8

- Share of coarse waste (oversize) is less with Barmac



Average flow time (sand flow cone)

Production of ASTM C33 Spec Sand

Crusher	Test	Oper. HP	Screen Undersize (STPH)	HP/Ton Screen Undersize	% Coarse Waste	%C33 Sand	% Fine Waste	STPH of C33 Sand	HP/Ton of C33 Sand	Feed	Speed*	CSS (in)	Cascade	Rotor	RR 80	aver flow time (s)	% voids	ASTM % voids
B9100	EE	500	163.2	3.06	25%	64%	12%	104.4	4.79	5/8" x 0	65	NA	0%	3-p Deep	1.32	24	37.5	44.0
B9100	DD	500	172.9	2.89	26%	63%	11%	108.9	4.59	5/8" x 0	60	NA	0%	3-p Deep	1.40	24.2	38.3	44.5
B9100	N	495	129.8	3.81	24%	63%	14%	81.8	6.05	1" x 1/4"	65	NA	0%	4-p Deep	1.47	24.7	38.0	43.1
B9100	S	505	145.7	3.47	29%	60%	11%	87.4	5.78	1" x 1/4"	55	NA	0%	3-p Deep	1.56	25.2	38.0	44.6
B9100	E	495	184.4	2.68	29%	60%	11%	110.6	4.47	5/8" x 0	55	NA	0%	4-p Deep	1.34	25.4	38.6	46.5
B9100	C	500	158.4	3.16	25%	62%	13%	98.2	5.09	5/8" x 0	65	NA	0%	3-p Std.	1.28	25.4	37.8	43.5
B9100	F	495	176.9	2.80	26%	62%	11%	109.7	4.51	5/8" x 0	60	NA	0%	4-p Deep	1.33	25.5	38.2	44.3
B9100	A	490	158.6	3.09	27%	61%	12%	96.7	5.06	5/8" x 0	60	NA	0%	3-p Std.	1.30	25.5	38.7	43.6
B9100	U	500	141.4	3.54	22%	66%	12%	93.3	5.36	1" x 1/4"	65	NA	0%	3-p Deep	1.43	25.5	37.8	44.0
B9100	BB	500	275.1	1.82	44%	49%	7%	134.8	3.71	3/8" x 1/8"	60	NA	0%	3-p Deep	1.20	25.7	39.0	44.8
B9100	T	500	136.9	3.65	25%	63%	12%	86.2	5.80	1" x 1/4"	60	NA	0%	3-p Deep	1.30	25.8	38.0	44.8
B9100	B	490	171.8	2.85	29%	60%	11%	103.1	4.75	5/8" x 0	55	NA	0%	3-p Std.	1.20	26.1	38.3	44.0
B9100	V	495	150.4	3.29	28%	61%	12%	91.7	5.40	1" x 1/4"	60	NA	10%	3-p Deep	NA	26.2	37.9	43.7
B9100	W	498	158.1	3.15	27%	61%	12%	96.4	5.16	1" x 1/4"	60	NA	20%	3-p Deep	1.56	26.3	38.4	45.1
B9100	M	490	138.5	3.54	26%	62%	12%	85.9	5.71	1" x 1/4"	60	NA	0%	4-p Deep	1.79	27.2	38.3	44.0
B9100	L	490	145.9	3.36	26%	63%	12%	91.9	5.33	1" x 1/4"	55	NA	0%	4-p Deep	1.44	27.3	38.3	44.7
HP100	AA	111	82.7	1.34	67%	27%	6%	22.3	4.97	3/8" x 1/8"	1100	0.38"	NA	NA	1.16	27.4	40.2	45.1
HP100	O	87	47.3	1.84	40%	51%	9%	24.1	3.61	1" x 1/4"	1100	0.38"	NA	NA	1.60	28.2	41.8	46.8
HP100	H	57	30.8	1.85	49%	44%	7%	13.6	4.21	5/8" x 0	1100	0.44"	NA	NA	1.13	28.2	41.5	43.8
HP100	P	56	29.4	1.90	51%	41%	8%	12.1	4.65	1" x 1/4"	1200	0.38"	NA	NA	1.31	28.2	41.8	45.9
HP100	Q	111	46	2.41	41%	50%	8%	23.0	4.83	1" x 1/4"	1000	0.38"	NA	NA	1.55	29.1	41.8	46.6
HP100	J	51	30.6	1.67	44%	49%	7%	15.0	3.40	5/8" x 0	1200	0.44"	NA	NA	1.15	29.3	41.7	45.1
HP100	R	83	36.3	2.29	51%	40%	9%	14.5	5.72	1" x 1/4"	1100	0.44"	NA	NA	1.29	30.5	42.1	47.4
HP100	Y	83	89.5	0.93	71%	24%	4%	21.5	3.86	3/8" x 1/8"	1100	0.44"	NA	NA	1.10	31	40.0	44.2
HP100	X	63	90.9	0.69	76%	20%	4%	18.2	3.47	3/8" x 1/8"	1100	0.48"	NA	NA	1.07	33.6	39.5	43.8
HP100	Z	63	82.7	0.76	74%	22%	3%	18.2	3.46	3/8" x 1/8"	1200	0.44"	NA	NA	1.09	33.7	39.7	44.3
HP100	I	69	44	1.57	57%	36%	6%	15.8	4.36	5/8" x 0	1100	0.44"	NA	NA	1.18	*	*	44.7

- Barmac sand flows faster through flowcone (rounder shape)



NZ void %

Production of ASTM C33 Spec Sand

Crusher	Test	Oper. HP	Screen Undersize (STPH)	HP/Ton Screen Undersize	% Coarse Waste	%C33 Sand	% Fine Waste	STPH of C33 Sand	HP/Ton of C33 Sand	Bruno Screen Setup	Feed	Speed*	CSS (in)	Cascade	Rotor	RR 80	aver flow time (s)	% voids	ASTM % voids
B9100	EE	500	163.2	3.06	25 %	64 %	12 %	104.4	4.79	A	5/8" x 0	65	NA	0 %	3-p Deep	1.32	24	37.5	44.0
B9100	C	500	158.4	3.16	25 %	62 %	13 %	98.2	5.09	A	5/8" x 0	65	NA	0 %	3-p Std.	1.28	25.4	37.8	43.5
B9100	U	500	141.4	3.54	22 %	66 %	12 %	93.3	5.36	A	1" x 1/4"	65	NA	0 %	3-p Deep	1.43	25.5	37.8	44.0
B9100	V	495	150.4	3.29	28 %	61 %	12 %	91.7	5.40	A	1" x 1/4"	60	NA	10 %	3-p Deep	NA	26.2	37.9	43.7
B9100	N	495	129.8	3.81	24 %	63 %	14 %	81.8	6.05	A	1" x 1/4"	65	NA	0 %	4-p Deep	1.47	24.7	38.0	43.1
B9100	S	505	145.7	3.47	29 %	60 %	11 %	87.4	5.78	A	1" x 1/4"	55	NA	0 %	3-p Deep	1.56	25.2	38.0	44.6
B9100	T	500	136.9	3.65	25 %	63 %	12 %	86.2	5.80	A	1" x 1/4"	60	NA	0 %	3-p Deep	1.30	25.8	38.0	44.8
B9100	F	495	176.9	2.80	26 %	62 %	11 %	109.7	4.51	A	5/8" x 0	60	NA	0 %	4-p Deep	1.33	25.5	38.2	44.3
B9100	B	490	171.8	2.85	29 %	60 %	11 %	103.1	4.75	A	5/8" x 0	55	NA	0 %	3-p Std.	1.20	26.1	38.3	44.0
B9100	L	490	145.9	3.36	26 %	63 %	12 %	91.9	5.33	A	1" x 1/4"	55	NA	0 %	4-p Deep	1.44	27.3	38.3	44.7
B9100	M	490	138.5	3.54	26 %	62 %	12 %	85.9	5.71	A	1" x 1/4"	60	NA	0 %	4-p Deep	1.79	27.2	38.3	44.0
B9100	DD	500	172.9	2.89	26 %	63 %	11 %	108.9	4.59	A	5/8" x 0	60	NA	0 %	3-p Deep	1.40	24.2	38.3	44.5
B9100	W	498	158.1	3.15	27 %	61 %	12 %	96.4	5.16	A	1" x 1/4"	60	NA	20 %	3-p Deep	1.56	26.3	38.4	45.1
B9100	E	495	184.4	2.68	29 %	60 %	11 %	110.6	4.47	A	5/8" x 0	55	NA	0 %	4-p Deep	1.34	25.4	38.6	46.5
B9100	A	490	158.6	3.09	27 %	61 %	12 %	96.7	5.06	A	5/8" x 0	60	NA	0 %	3-p Std.	1.30	25.5	38.7	43.6
B9100	BB	500	275.1	1.82	44 %	49 %	7 %	134.8	3.71	E	3/8" x 1/8"	60	NA	0 %	3-p Deep	1.20	25.7	39.0	44.8
HP100	X	63	90.9	0.69	76 %	20 %	4 %	18.2	3.47	D	3/8" x 1/8"	1100	0.48"	NA	NA	1.07	33.6	39.5	43.6
HP100	Z	63	82.7	0.76	74 %	22 %	3 %	18.2	3.46	D	3/8" x 1/8"	1200	0.44"	NA	NA	1.09	33.7	39.7	44.3
HP100	Y	83	89.5	0.93	71 %	24 %	4 %	21.5	3.86	D	3/8" x 1/8"	1100	0.44"	NA	NA	1.10	31	40.0	44.2
HP100	AA	111	82.7	1.34	67 %	27 %	6 %	22.3	4.97	D	3/8" x 1/8"	1100	0.38"	NA	NA	1.16	27.4	40.2	45.1
HP100	H	57	30.8	1.85	49 %	44 %	7 %	13.6	4.21	B	5/8" x 0	1100	0.44"	NA	NA	1.13	28.2	41.5	43.8
HP100	J	51	30.6	1.67	44 %	49 %	7 %	15.0	3.40	B	5/8" x 0	1200	0.44"	NA	NA	1.15	29.3	41.7	45.1
HP100	O	87	47.3	1.84	40 %	51 %	9 %	24.1	3.61	B	1" x 1/4"	1100	0.38"	NA	NA	1.60	28.2	41.8	46.8
HP100	P	56	29.4	1.90	51 %	41 %	8 %	12.1	4.65	B	1" x 1/4"	1200	0.38"	NA	NA	1.31	28.2	41.8	45.9
HP100	Q	111	46	2.41	41 %	50 %	8 %	23.0	4.83	B	1" x 1/4"	1000	0.38"	NA	NA	1.55	29.1	41.8	46.6
HP100	R	83	36.3	2.29	51 %	40 %	9 %	14.5	5.72	C	1" x 1/4"	1100	0.44"	NA	NA	1.29	30.5	42.1	47.4
HP100	I	69	44	1.57	57 %	36 %	6 %	15.8	4.36	C	5/8" x 0	1100	0.44"	NA	NA	1.18			44.7

- Barmac sand gives lower void % (rounder shape)



Some averages

Calculated from Screen undersize)

Production of ASTM C33 Spec Sand

Crusher	Test	Oper. HP	Screen Undersize (STPH)	HP/Ton Screen Undersize	% Coarse Waste	%C33 Sand	% Fine Waste	STPH of C33 Sand	HP/Ton of C33 Sand	Bruno Screen Setup	Feed	Speed*	CSS (in)	Cascade	Rotor	RR 80	aver flow time (s)	% voids	ASTM % voids	
																				Feed
B9100	EE	500	163.2	3.06	25 %	64 %	12 %	104.4	4.79	A	5/8" x 0	65	NA	0 %	3-p Deep	1.32	24	37.5	44.0	
B9100	DD	500	172.9	2.89	26 %	63 %	11 %	108.9	4.59	A	5/8" x 0	60	NA	0 %	3-p Deep	1.40	24.2	38.3	44.5	
B9100	N	495	129.8	3.81	24 %	63 %	14 %	81.8	6.05	A	1" x 1/4"	65	NA	0 %	4-p Deep	1.47	24.7	38.0	43.1	
B9100	S	505	145.7	3.47	29 %	60 %	11 %	87.4	5.78	A	1" x 1/4"	55	NA	0 %	3-p Deep	1.56	25.2	38.0	44.6	
B9100	C	500	158.4	3.16	25 %	62 %	13 %	98.2	5.09	A	5/8" x 0	65	NA	0 %	3-p Deep	1.28	25.4	37.8	43.5	
B9100	E	495	184.4	2.68	29 %	60 %	11 %	110.6	4.47	A	5/8" x 0	55	NA	0 %	4-p Deep	1.34	25.4	38.6	46.5	
B9100	A	490	158.6	3.09	27 %	61 %	12 %	96.7	5.06	A	5/8" x 0	60	NA	0 %	3-p Std.	1.30	25.5	38.7	43.6	
B9100	F	495	176.9	2.80	26 %	62 %	11 %	109.7	4.51	A	5/8" x 0	60	NA	0 %	4-p Deep	1.33	25.5	38.2	44.3	
B9100	U	500	141.4	3.54	22 %	66 %	12 %	93.3	5.36	A	1" x 1/4"	65	NA	0 %	3-p Deep	1.43	25.5	37.8	44.0	
B9100	BB	500	275.1	1.82	44 %	49 %	7 %	134.8	3.71	E	3/8" x 1/8"	60	NA	0 %	3-p Deep	1.20	25.7	39.0	44.8	
B9100	T	500	136.9	3.65	25 %	63 %	12 %	86.2	5.80	A	1" x 1/4"	60	NA	0 %	3-p Deep	1.30	25.8	38.0	44.8	
B9100	B	490	171.8	2.85	29 %	60 %	11 %	103.1	4.75	A	5/8" x 0	55	NA	0 %	3-p Std.	1.20	26.1	38.3	44.0	
B9100	V	495	150.4	3.29	28 %	61 %	12 %	91.7	5.40	A	1" x 1/4"	60	NA	10 %	3-p Deep	NA	26.2	37.9	43.7	
B9100	W	498	158.1	3.15	27 %	61 %	12 %	96.4	5.16	A	1" x 1/4"	60	NA	20 %	3-p Deep	1.56	26.3	38.4	45.1	
B9100	M	490	138.5	3.54	26 %	62 %	12 %	85.9	5.71	A	1" x 1/4"	60	NA	0 %	4-p Deep	1.79	27.2	38.3	44.0	
B9100	L	490	145.9	3.36	26 %	63 %	12 %	91.9	5.33	A	1" x 1/4"	55	NA	0 %	4-p Deep	1.44	27.3	38.3	44.7	
			496.4	163.0	3.13	0.27	0.61	0.12	98.8	5.10	#		60.0		0.02		1.39	25.63	38.19	44.31
HP100	AA	111	82.7	1.34	67 %	27 %	6 %	22.3	4.97	D	3/8" x 1/8"	1100	0.38"	NA	NA	1.16	27.4	40.2	45.1	
HP100	H	57	30.8	1.85	49 %	44 %	7 %	13.6	4.21	B	5/8" x 0	1100	0.44"	NA	NA	1.13	28.2	41.5	43.8	
HP100	P	56	29.4	1.90	51 %	41 %	8 %	12.1	4.65	B	1" x 1/4"	1200	0.38"	NA	NA	1.31	28.2	41.8	45.9	
HP100	O	87	47.3	1.84	40 %	51 %	9 %	24.1	3.61	B	1" x 1/4"	1100	0.38"	NA	NA	1.60	28.2	41.8	46.8	
HP100	Q	111	46	2.41	41 %	50 %	8 %	23.0	4.83	B	1" x 1/4"	1000	0.38"	NA	NA	1.55	29.1	41.8	46.6	
HP100	J	51	30.6	1.67	44 %	49 %	7 %	15.0	3.40	B	5/8" x 0	1200	0.44"	NA	NA	1.15	29.3	41.7	45.1	
HP100	R	83	36.3	2.29	51 %	40 %	9 %	14.5	5.72	C	1" x 1/4"	1100	0.44"	NA	NA	1.29	30.5	42.1	47.4	
HP100	Y	83	89.5	0.93	71 %	24 %	4 %	21.5	3.86	D	3/8" x 1/8"	1100	0.44"	NA	NA	1.10	31	40.0	44.2	
HP100	X	63	90.9	0.69	76 %	20 %	4 %	18.2	3.47	D	3/8" x 1/8"	1100	0.48"	NA	NA	1.07	33.6	39.5	43.6	
HP100	Z	63	82.7	0.76	74 %	22 %	3 %	18.2	3.46	D	3/8" x 1/8"	1200	0.44"	NA	NA	1.09	33.7	39.7	44.3	
HP100	I	69	44	1.57	57 %	36 %	6 %	15.8	4.36	C	5/8" x 0	1100	0.44"	NA	NA	1.18				44.7
			75.8	55.5	1.57	0.56	0.37	0.06	18.0	4.23	#		1118.2				1.24	29.92	41.01	45.23

- Barmac makes better quality sand with somewhat higher reduction ratio
- Barmac produces twice so much fines as HP. HP produces oversize twice Barmac



Flow time vs void % comparisons

- Barmac has lower values

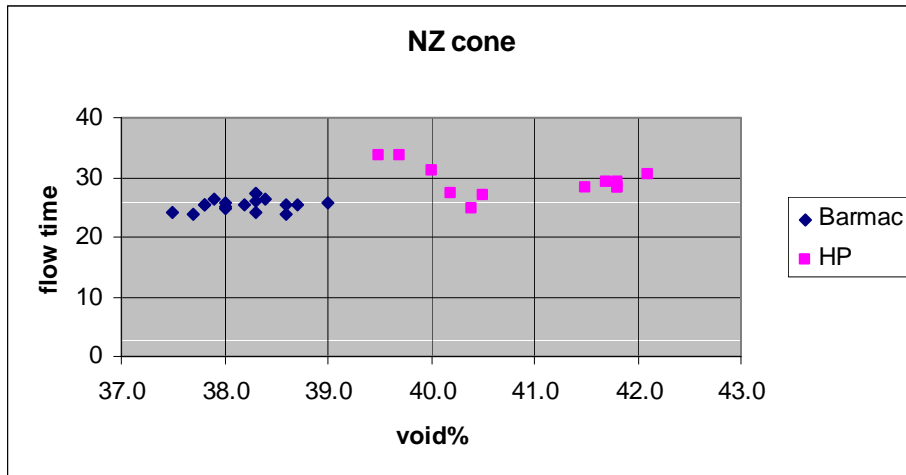

Flow time vs void % comparisons

- Finer feed gives in general better flow cone and void content values = shape of sand is better

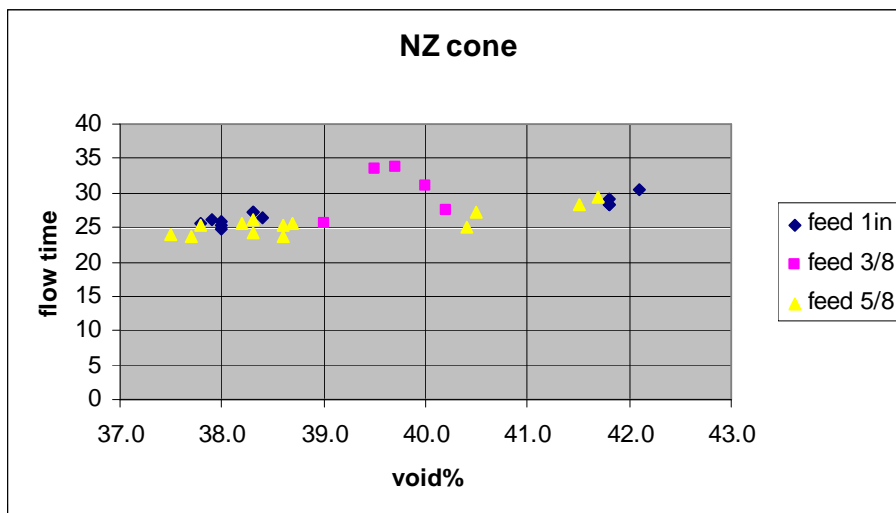

NZ Flowcone Results

Flow time vs void % comparisons

- Barmac gives better void % with coarser feed
- As to sand quality Barmac is not so responsive to coarser feed as HP
- HP behaviour is somewhat unlogical because finest feed gives longest flowtime. Reason seems to be coarser 3/8" feed.
- All Barmac sand fullfills NZ flowcone criteria. 50% of HP sand fullfills same criteria

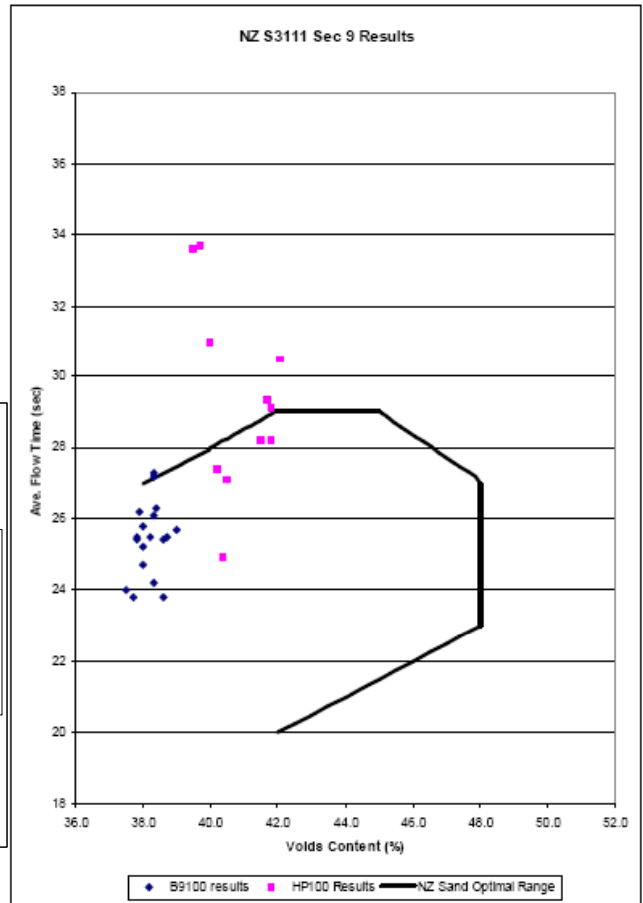
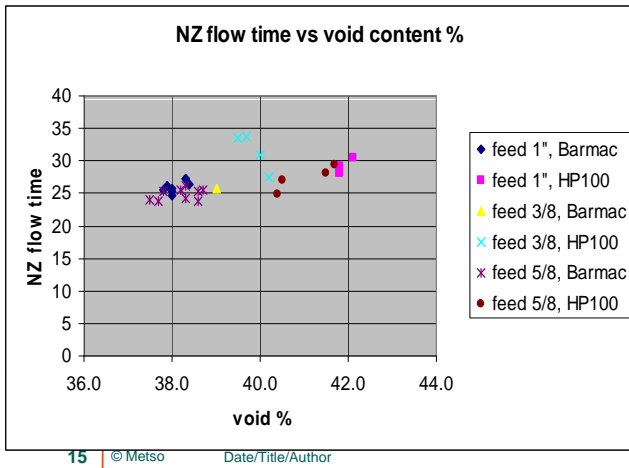

Void content / flow time vs. reduction ratio

- Some reduction ratio is needed to improve flowtime
- With coarser feed Barmac gives better void content and even with higher red.ratio
- Average reduction ratio with Barmac is higher and sand quality in average is better than with HP (see also average table before)
- Barmac results are more consistent when feed fraction changes

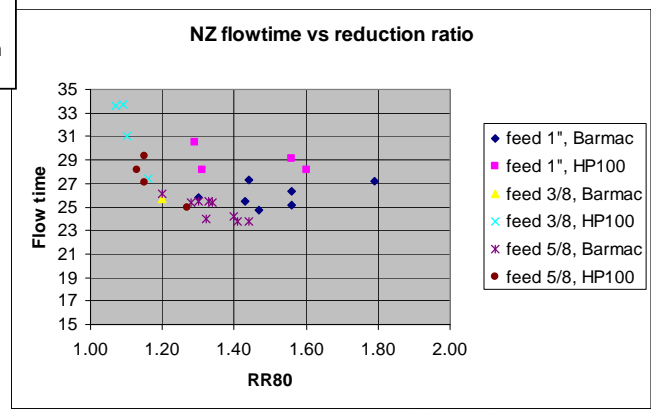
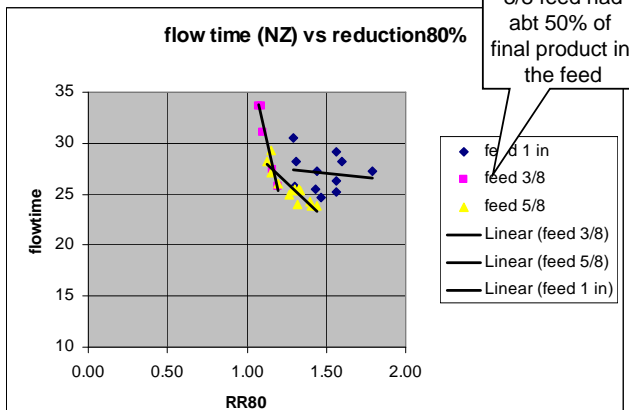
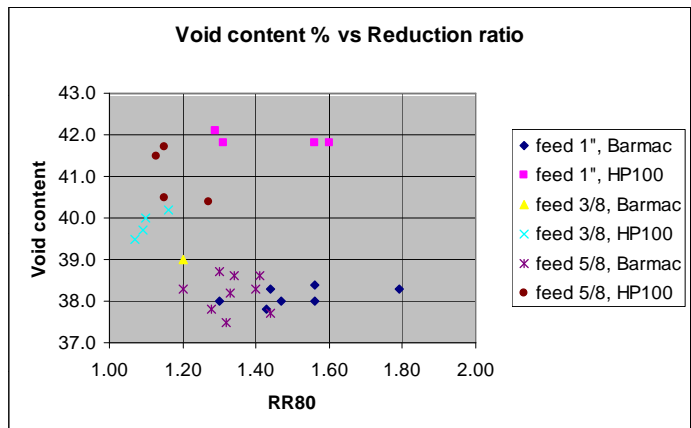

Conclusions

	Soft rock (measured), Crushability 56%			
	Barmac	HP	Crusher selection to	
			Concrete	Asphalt
Yield of sand (% of feed)	high	medium	B	B
Energy/produced sand ton	higher	lower	HP	HP
Fines (<0,07mm) 1)	more	less	HP	HP
Oversize (> 2,5mm) 2)	less	more	B	B
Flowtime through flowcone (roundness)	shorter	longer	B	HP
Void content	lower	higher	B	HP
Void content with coarser feed	lower	higher	B	HP
Ability to produce consistent sand 3)	lower variation	higher variation	B	B
Ability to produce high quality of sand with higher reduction ratio	good	medium	B	B
Ability to produce high quality sand if feed is 1-10mm	good	should be good but variations in tests	B	HP
Ability to produce high quality sand if feed is 1-15mm	good	good	B/HP	B/HP
Ability to produce high quality sand if feed is 1-25mm	good	medium	B	HP
Cost / ton estimate	?	?		

1) fines in screen undersize: Barmac 12%, HP 6%. Fines in crusher product: Barmac 7%, HP 3,6%

2) oversize in crusher product: Barmac 60,2%; HP 70,1%

3) change in crusher wear profile increases variation

General notes
Some reduction ratio is needed to improve flowtime (shape)
Feed to HP has to be 50-100% < CSS
Pumping characteristics in concrete is important factor. Aggregate and sand shape play important role
Higher speed in Barmac results higher amount of sand, higher HP/tons sand produced, higher amount of fines, less coarse product, improved flowtime and voids content.



Calculation related to sand simulation

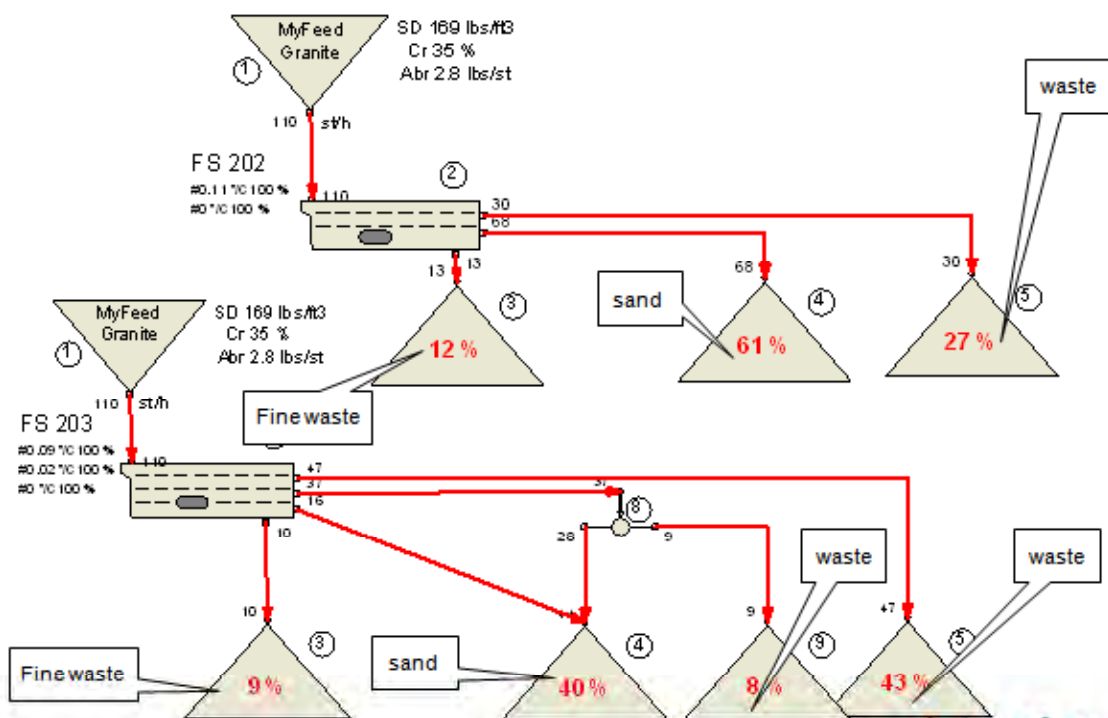

**COIN, 30 - 31 October 2008
Stavanger, Norway**



**Microstructure versus mechanical properties and
influence on aggregate production
(A contribution to project planning and collaboration)**

CBI, Swedish Cement and Concrete Research Institute



SP, Technical Research
Institute of Sweden

**CBI, A company in the
SP group**



CBI, Swedish Cement and Concrete Research Institute

**Björn Schouenborg & Urban Åkesson
"Swedish Competence Centre for Rock Materials"
Tang Luping, Chalmers**

Contents



- Background – national and international needs
- **Suitable raw material - Characterization of the bedrock**
- *Aggregate production, crushing techniques*
- **Characterization of aggregates, microstructure and more**
- *Concrete production: Cement improvement, rheology of concrete, stability of the mix*
- Innovative solutions – Future collaboration possibilities

I have also used material from e.g.:

Tang Luping, SP (Concrete)

Urban Åkesson, SP (Image analysis of aggregates) **Many thanks!**

Svein Willy Danielsen, SINTEF (a lot! Seen here today as well)

CBI, Swedish Cement and Concrete Research Institute

Vision of the European Construction Technology Platform (ECTP)



from "A vision for a sustainable and competitive construction sector by 2030"

"In the year 2030, Europe's built environment is designed, built and maintained by a successful knowledge- and demand-driven sector, well known for its ability to satisfy all the needs of its clients and society, providing a high quality of life and demonstrating its long-term responsibility to mankind's environment".

"The negative impacts of construction's whole life-cycle on the environment are radically reduced"

<http://www.ectp.org/>

CBI, Swedish Cement and Concrete Research Institute

Needs of the industry and society?



A sustainable concrete production with 100 % crushed aggregates in several areas.

Sustainable means profitable, cost efficient and environmentally friendly. This requires that:

- We don't want to increase the use of cement and additives.
- We don't want to have long transportation distances of aggregates or other components.
- We want to be able to use locally available materials
- We also need to help the industry develop simple and quick test methods for their process control.
- We need to develop a methodology suitable for all crushed rock producers. Most of them being SMEs

CBI, Swedish Cement and Concrete Research Institute

A holistic view is needed when re-engineering the concrete production "construction's whole life-cycle"

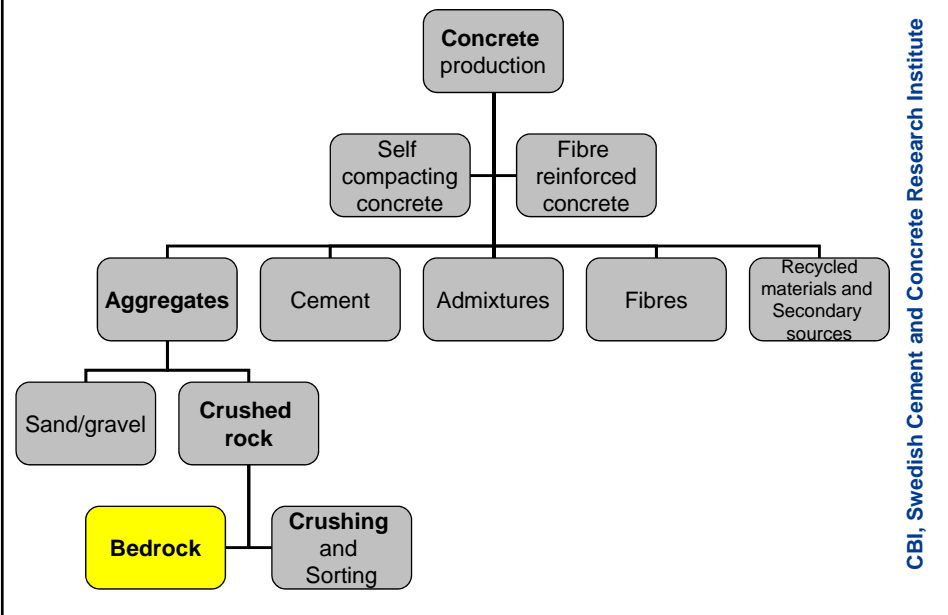

CBI, Swedish Cement and Concrete Research Institute

The bedrock - The main source of raw material

The choice of suitable bedrock is the key to a cost efficient production of totally crushed aggregates where the fine gradings can be used without too much further processing.



Photo: Svein Willy Danielsen

However, suitable bedrock is not everywhere available

There is an increasing shortage of natural sand and gravel deposits suitable for concrete and other civil engineering works. Especially close to larger cities where the infrastructural intensity of rebuilding is very large. Remaining deposits have, in many cases, to be left for ground water filtration, recreation areas etc ...
Environmental goals and other conflicting interests.

We have to learn how to make better use of locally available materials, not only bedrock but also waste (secondary aggregates and recycled aggregates).



CBI, Swedish Cement and Concrete Research Institute

Therefore, use the resources carefully!

Quality classification of bedrock for optimum use. Norway is a good example

Elements of BEDROCK quality classification

- Geological mapping and classical description of the bedrock
- Mapping of faults, joints etc.
- Aeromagnetic mapping
- Sampling of the bedrock
- Laboratory crushing and sieving in a defined way
- A set of tests to assess the potential use for concrete, asphalt, railway ballast. Petrographic analysis and

Add new elements depending on the needs.

CBI, Swedish Cement and Concrete Research Institute

The microstructure of the rock is the key to understanding many of the product properties (aggregates and natural stone)

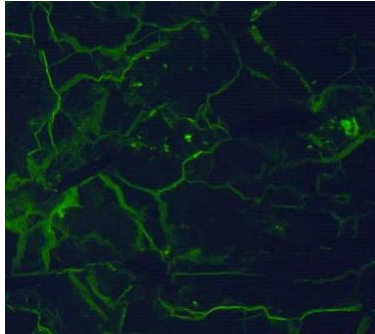
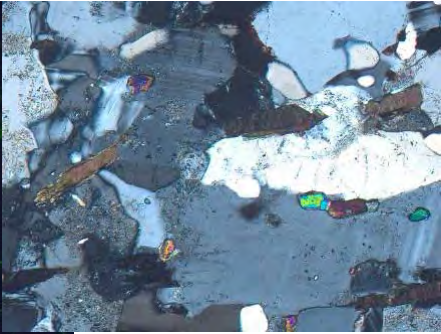

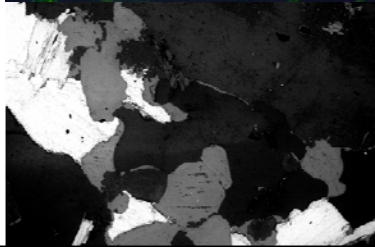
Aggregate production starts here where suitable bedrock meets the needs of the society



CBI, Swedish Cement and Concrete Research Institute

**Efficient evaluation of the bedrock potentials
SEM images show differences between two granites**

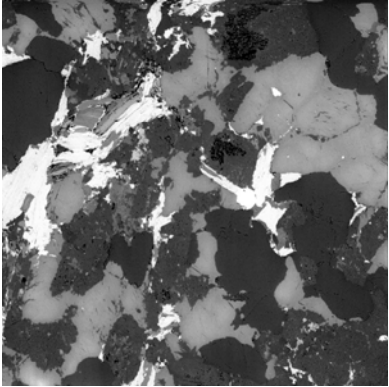
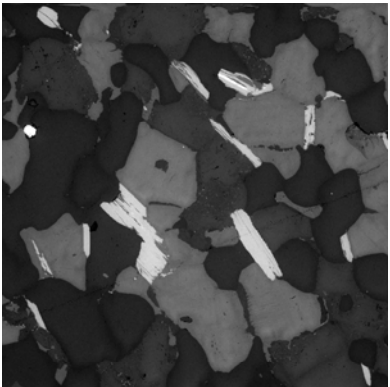
LA 14

LA 25

1.75 x 1.75 mm

LA = Los Angeles value. Chcrushing resistance of aggregate, important for e.g. choice and adjustment of crushers

CBI, Swedish Cement and Concrete Research Institute

Relationships between microstructure and mechanical properties (LA-value)



CBI, Swedish Cement and Concrete Research Institute

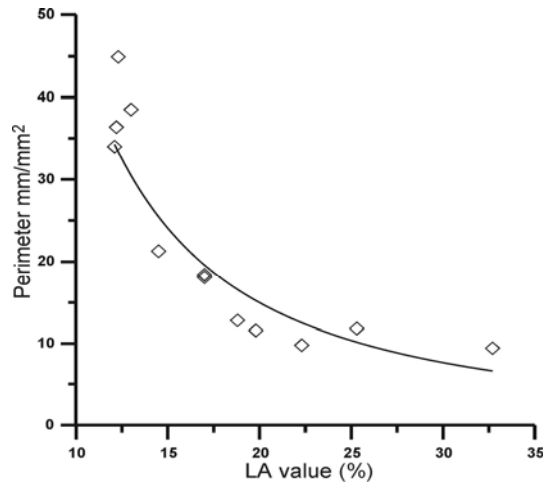

Many granites have a foliation



CBI, Swedish Cement and Concrete Research Institute

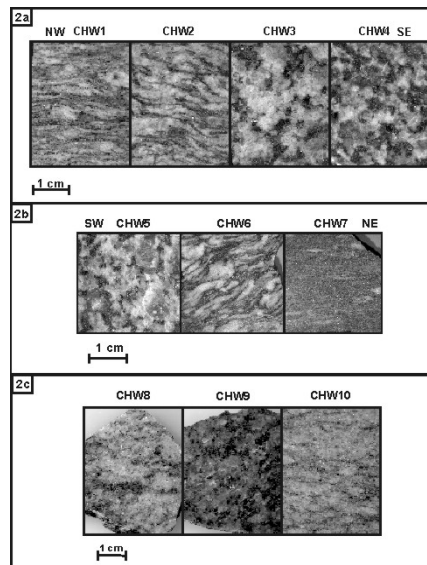
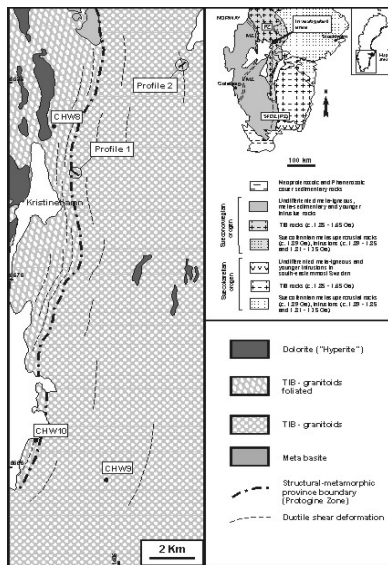

Add a foliation index and - Almost perfect correlation

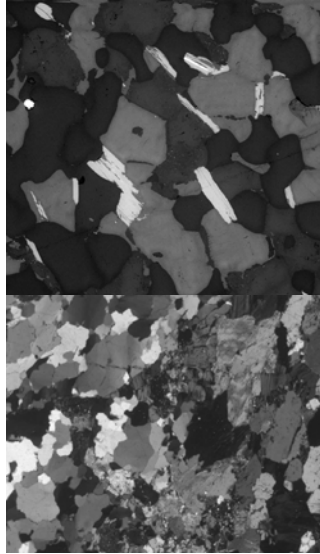

Correlation coefficient of 0,95

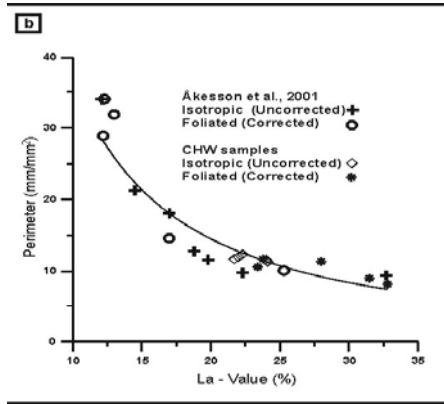

CBI, Swedish Cement and Concrete Research Institute

One step further, not only crushing resistance but also the shape of the product

The amount and type of **Microcracks** is important for the fragmentation and shape of the Aggregate

Several projects today on the correlation of cracks in different scales with various fragmentation Processes; blasting, crushing..

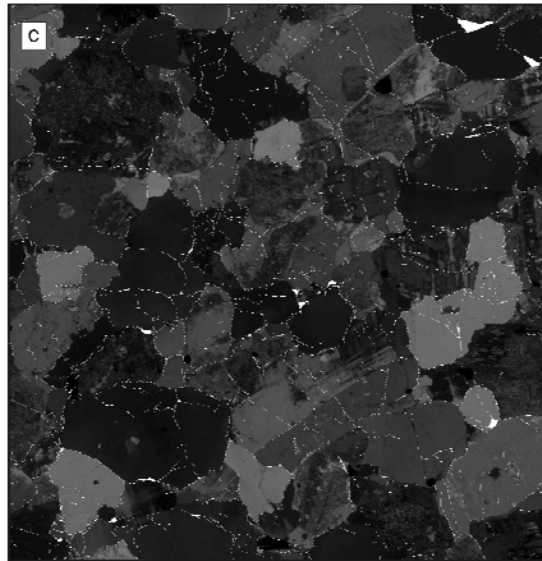

8x8 mm

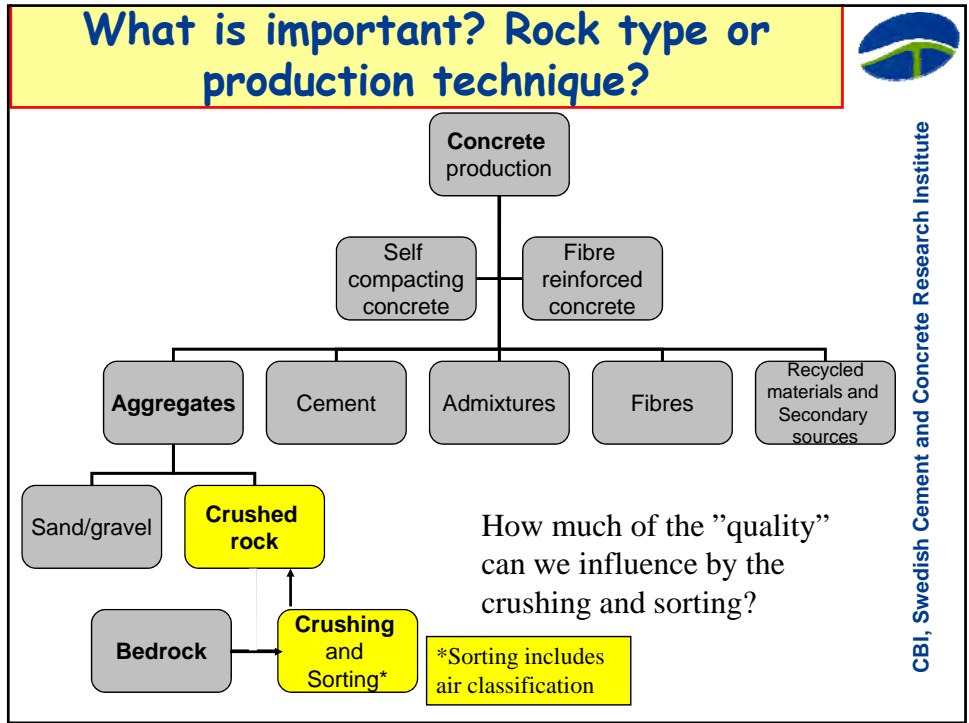

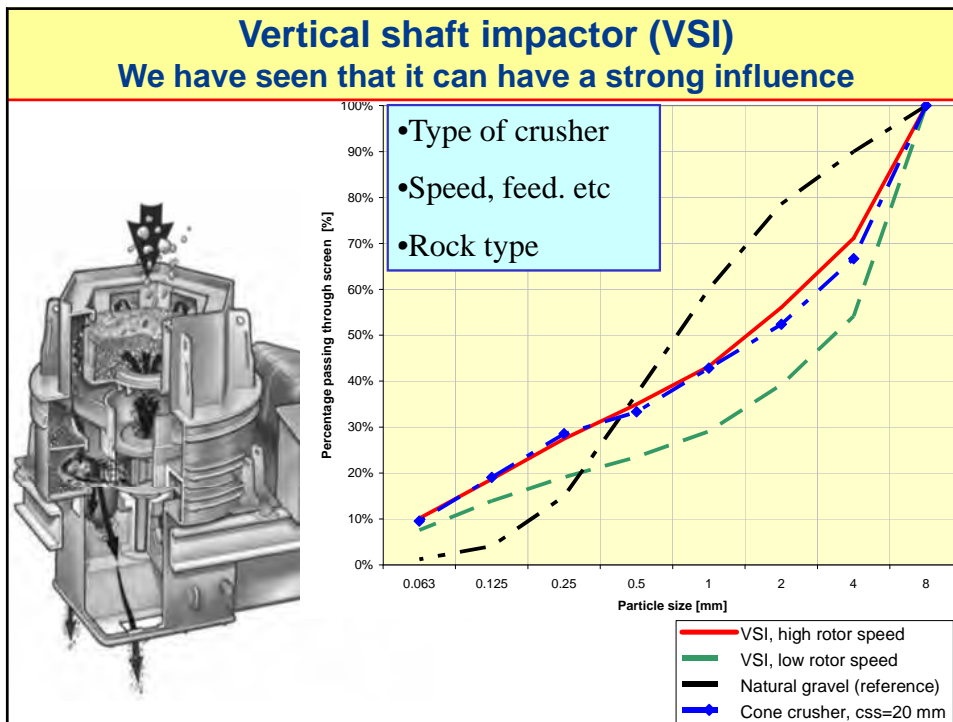

Air classification, example from NCC

The Centrifugal Classifier requires less handling equipment and ranges from 150 mesh to 15 microns

Photo: Kent A, NCC Stenungsund

Air classification – some advantages



Separates in better defined gradings than traditional sieve-sorting

This is especially important for more demanding concrete products. Several different size distributions can subsequently be "composed" in an easy way.

Can separate e.g. mica from the main product

Mica and other very flaky minerals can be separated. They may otherwise make concrete mixing troublesome.

Can be an alternative to VSI or combined with it **depending on the rock type, existing machinery and range of products**

CBI, Swedish Cement and Concrete Research Institute

Aggregates, the product

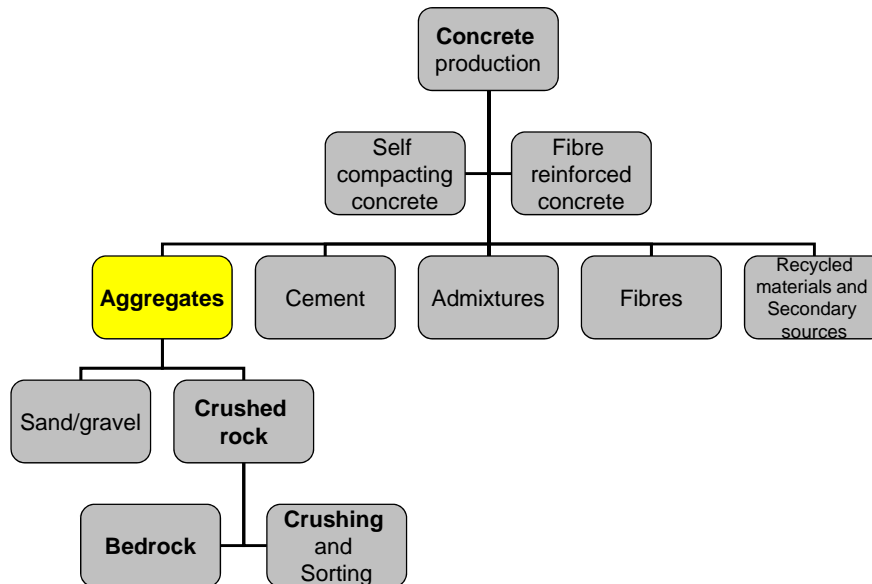

CBI, Swedish Cement and Concrete Research Institute

Aggregate characterisation: Shape, size and flow

Fluorescent epoxy impregnated thin sections
+250-500 microns

Institute

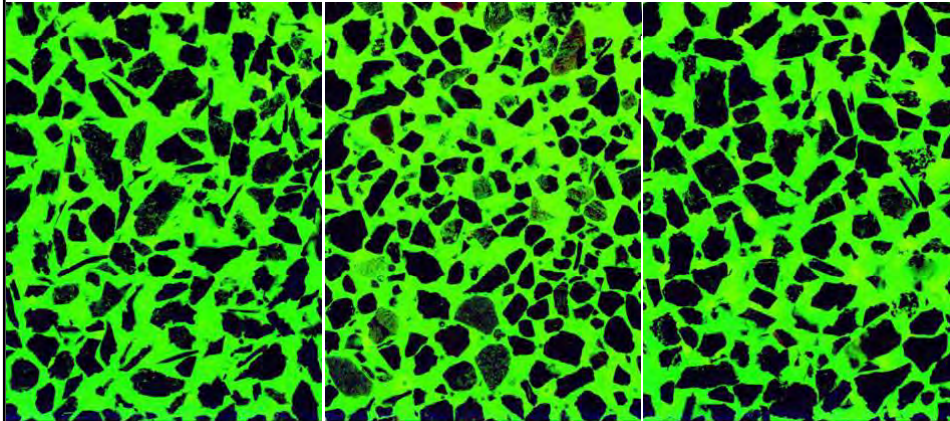

Cone Crusher

Natural Gravel

VSI

CBI

Aggregate characterisation: quantification of critical parameters

Scanning electron microscopy and computer aided image analysis are used for detailed characterisation of the fine aggregates.

The particle size distribution and the shape are measured.

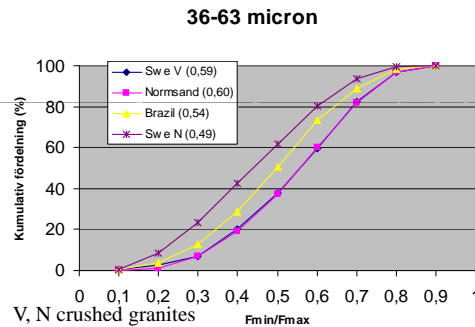
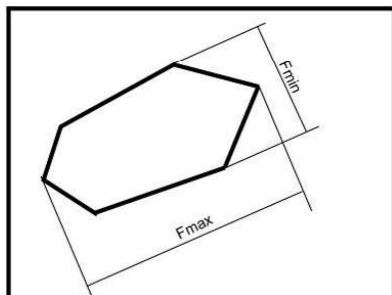
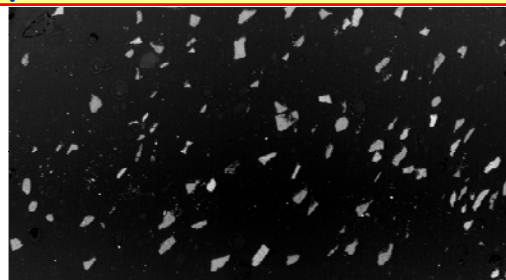

Favourable properties - Petrography



To produce a **good shape** in the finer size fractions (0,036 – 0,250 mm) a rock with small amounts of mica and amphiboles is preferable

To produce a good shape in the coarser size fractions (0,5 – 1,0 mm) a rock with complex texture is preferable

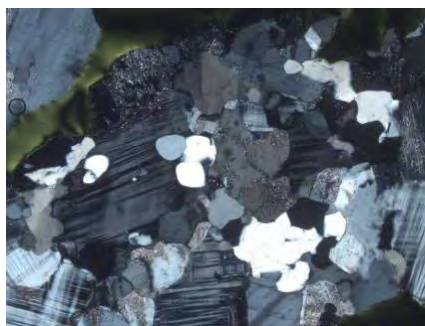

Quartz	45 %
Plagioclase	42 %
K-feldspar	7 %
Biotite	4 %
Chlorite	1 %
Amphibole	0,5 %

CBI, Swedish Cement and Concrete Research Institute

**If air classified or magnetic separated, don't forget the heavy elements!
You want to use the "left-over" LEACHING TEST RESULTS:**

	L/S 2		L/S 0-10	
	22436:1	Detektionsgräns	22436:1	Detektionsgräns
As (mg/kg)	0,0012	0,00002	0,0032	0,00009
Ba (mg/kg)	0,0050	0,0001	0,0052	0,0005
Cd (mg/kg)	0,0003	0,0001	<0,0005	0,0005
Co (mg/kg)	<0,0001	0,0001	<0,0006	0,0006
Cr (mg/kg)	<0,009	0,009	<0,04	0,04
Cu (mg/kg)	0,0096	0,0001	0,012	0,0007
Mo (mg/kg)	0,0098	0,0004	0,015	0,002
Ni (mg/kg)	0,0059	0,0001	0,015	0,0006
Pb (mg/kg)	0,0012	0,0002	0,0012	0,0009
Sb (mg/kg)	<0,0002	0,0002	<0,0009	0,0009
Se (mg/kg)	<0,002	0,002	<0,009	0,009
Tl (mg/kg)	<0,0001	0,0001	<0,0006	0,0006
V (mg/kg)	0,0042	0,0001	0,0083	0,0007
Zn (mg/kg)	0,036	0,0005	0,036	0,003
Hg (mg/kg)	<0,001	<0,001	<0,001	<0,001
F ⁻ (mg/kg)	0,49	0,2	<1	1
Cl ⁻ (mg/kg)	6,8	0,2	6,8	1

CBI, Swedish Cement and Concrete Research Institute

What else should be documented?



Aggregate samples should be followed by documentation of every possible influencing factor that we may need for interpreting the results and **be able to draw more far-reaching conclusions than merely for a single sample!** Whenever possible, we should try to document:

- Bedrock mapping and crack patterns in the rock
- MWD (measurement while drilling)
- Blasting conditions
- Petrographic composition of different gradings at different stages in the production
- Crushing conditions, speed, energy, openings...
- Weather conditions or at least moisture content
- Which products are produced together with the sampled one.
- Feed-back to bedrock quality mapping

CBI, Swedish Cement and Concrete Research Institute

Sample and document more! Why is this so important?



Because a single sample is no more than a single sample!
Sounds obvious doesn't it? Especially when we know that all aggregates vary with the production.

Remember the goal! We need to be able to develop concrete mixes that are rugged enough to cope with the variations in the aggregate and cement production. One single sample from each quarry doesn't help us do this.

Individual success stories have their value but we need to extract and compile the essential information from all of them to make them more generally usable!

CBI, Swedish Cement and Concrete Research Institute

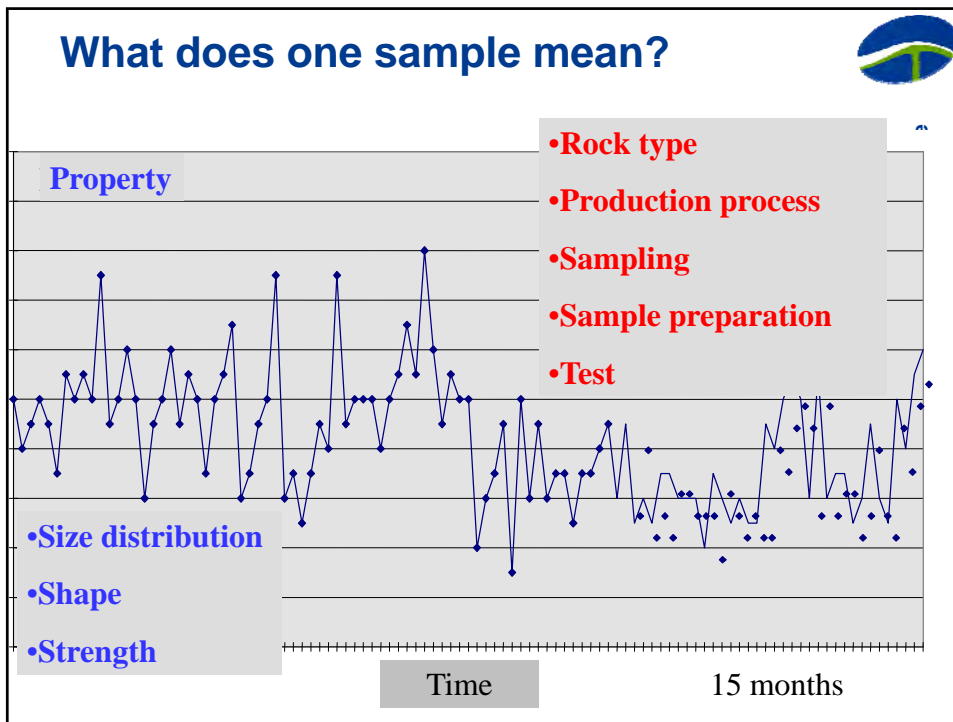

A more efficient way to plan a project is to define parameters of interest and sample what you need to answer the relevant questions

Mica content 0-5 %	Micro structure
Micro-fine grained	homo
Fine-medium grained	homo
Fine-medium grained	hetero
Fine-medium grained	homo
Medium-coarse grained	homo
Mica content 5-10 %	
Micro-fine grained	hetero
Fine-medium grained	homo
Medium-coarse grained	homo
Mica content >10 %	
Micro-fine grained	homo
Fine-medium grained	hetero
Fine-medium grained	hetero foliated
Fine-medium grained	hetero

We already have a lot of information from product certification of aggregates

CBI, Swedish Cement and Concrete Research Institute

**What can we measure in the quarry or concrete factory?
Aggregate characterisation in the production plant**



EN 933-6 Flow coefficient of aggregates

The flow coefficient depends on the

- shape,
- rugosity
- size distribution
- density

Fine aggregate



Coarse aggregate

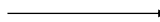

Mass Flow Rate vs Material Type and Fraction Size



The work of e.g. Magnus Bengtsson (doctoral student at Chalmers, Gothenburgh, Sweden) clearly shows that it works

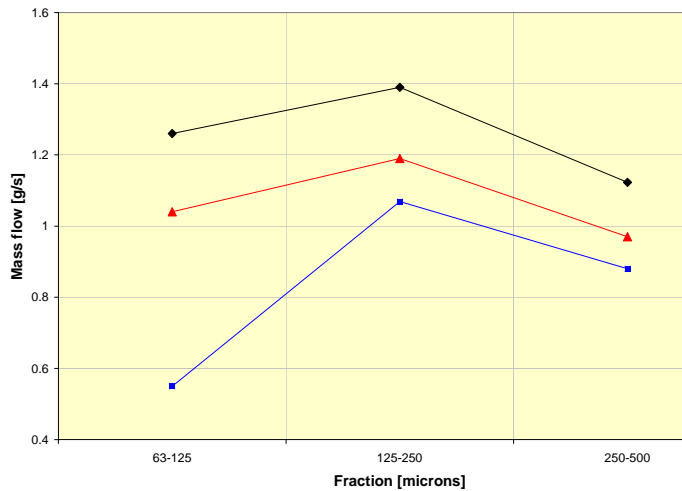

CBI, Swedish Cement and Concrete Research Institute

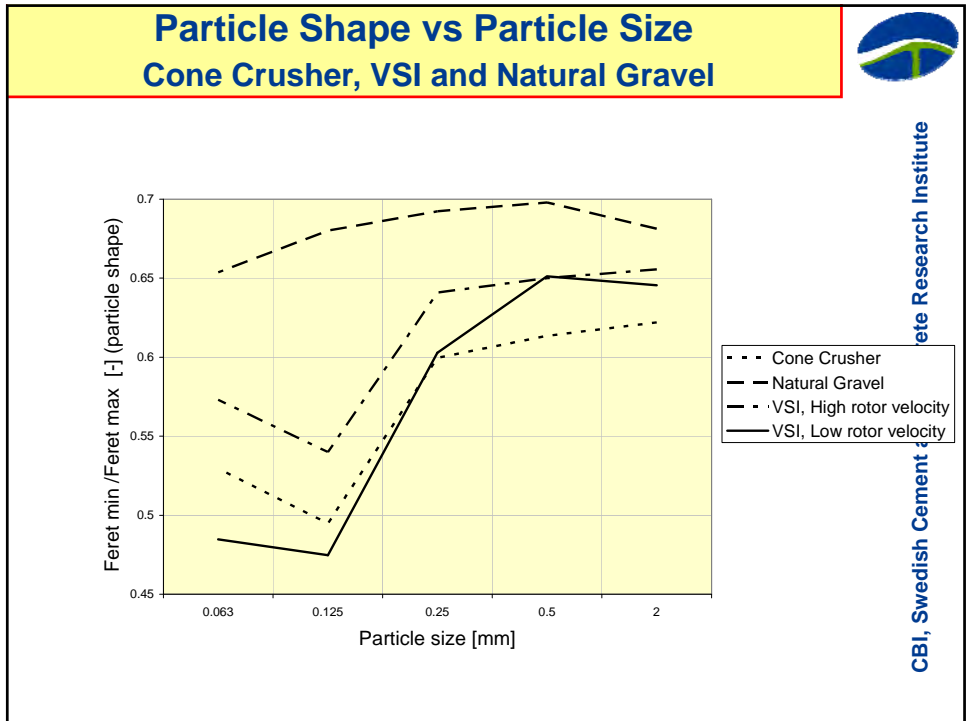

Cement Research Institute
CBI, Swedish Cement and Concrete Research Institute

Most producers need immediate answers! Advanced on-line techniques can be a solution in larger quarries?

Particle and shape analysers are becoming more and more available also for the producer labs.

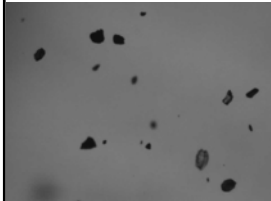

Images of fine and coarse particles

Including the distribution

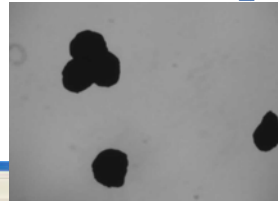

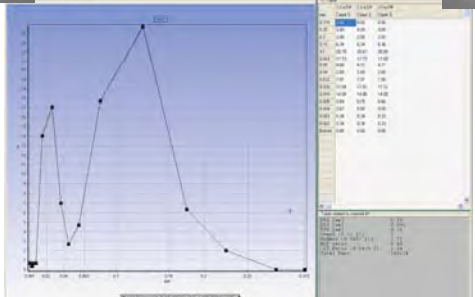



Cement Research Institute
CBI, Swedish Cement and Concrete Research Institute

AnaTec's Particle analyser 0-32mm



Automatic samplers are designed for each plant

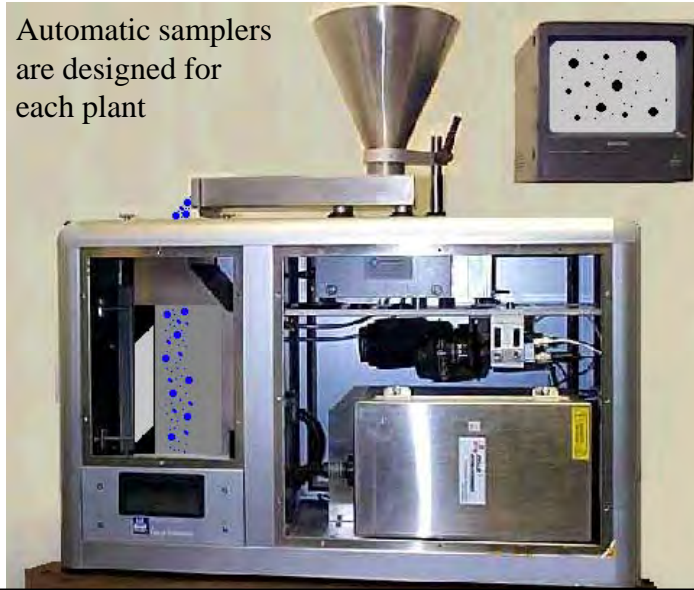

CBI, Swedish Cement and Concrete Research Institute

The cement system

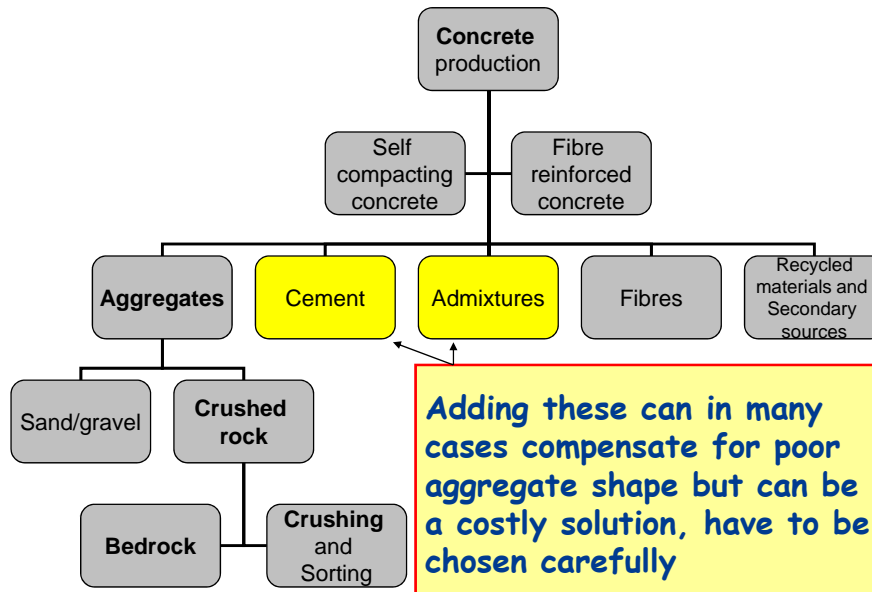

CBI, Swedish Cement and Concrete Research Institute

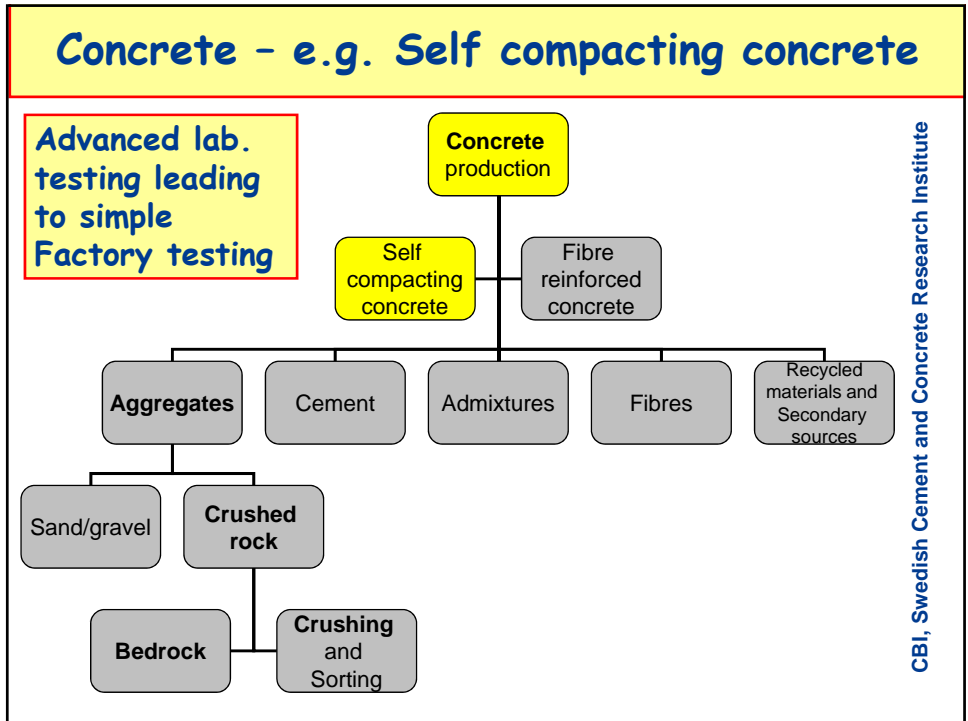

Advanced laboratory tests



Rheology in cement paste, mortar and then concrete

Tixotropy, etc

Leading to quicker and more simple production tests

Photos from Mapei Milano



CBI, Swedish Cement and Concrete Research Institute

Factory tests of fresh concrete properties



Concrete Research Institute

The rheology of the concrete and its stability are of crucial importance and should be possible to measure in the production plant!

➤ Filling ability

Methods: slump flow, **J-ring**, V-funnel, etc.

➤ Passing ability

Methods: L-box, **J-ring**, etc.

➤ Stability (Resistance to segregation)

Methods: sieve stability test, **J-ring**, etc.

New Nordic standard
NT BUILD 507
for industrial QC

Blocking

$$B_J = \frac{\sum \Delta h_i}{4} - \Delta h_0$$

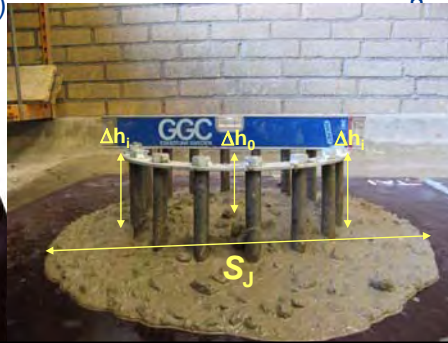
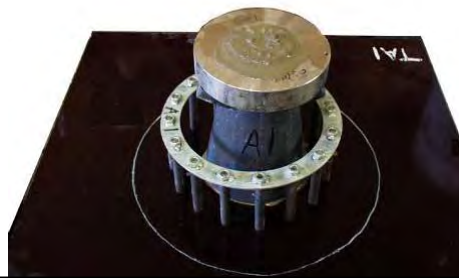

The concrete, continued



Test of stability with the J-ring, a few minutes after mixing.

The method is suitable for both lab. and field analysis

The consistency has to be stable from the production plant all the way out to the construction site!

Top part of sample

Bottom part of sample

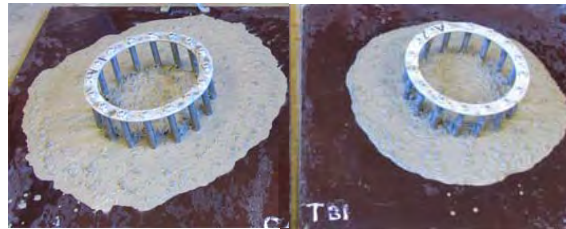

Small difference – stability is ok.

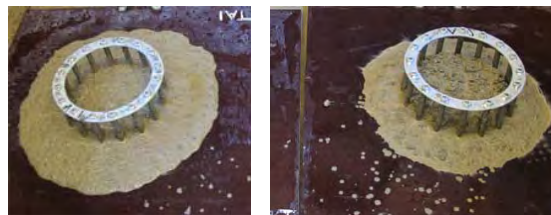

Significant difference – stability is not ok

The new material/production chain: Avoid trial and error! Transfer the knowledge from one place to the other

Knowledge-based concrete proportioning as the central part to design concrete mixtures based on performance based requirements with optimised use of local raw materials and local producers (incl. recycled materials):

Knowledge-based **rock characterisation** of crucial parameters for cost efficient production of totally crushed aggregates suitable for concrete

Knowledge based **aggregate production/rock crushing** with the techniques maximally fulfilling the optimised requirements from concrete proportioning.

Optimised particle **shape characterisation** with the help of SEM and image analysis, conversion to tests applicable in the industry such as, e.g. **Flow coefficient**

Optimised **particle size distribution** of aggregates with the help of **non-spherical packing algorithm**. Not based on natural sand distributions!

CBI, Swedish Cement and Concrete Research Institute

The new material/production chain, continued:

Knowledge-based **cement, fibre and admixture** production/development for maximally fulfilling the functional requirements of concrete.

Optimised use of **cementitious materials** (cement and various pozzolanic by-products) with the help of LCA for maximum reduction of CO₂ emission;

Optimised use of **fibres** for functions of reinforcement, cracking resistance, fire resistance, etc.;

Optimised use of **admixtures** for proper workability, frost resistance, corrosion resistance, etc.

Knowledge-based **recycling** for maximal reuse of demolished concrete.

Instrumented **QA system** from raw materials to final product of concrete.

CBI, Swedish Cement and Concrete Research Institute

Join E2B and influence the future European research!

Anyone interested in collaboration in this area is welcome to use these contacts:

bjorn.schouenborg@sp.se
tang.luping@sp.se
urban.akesson@sp.se
svein.danielsen@sintef.no

• <http://www.e2b-jti.eu/>



**Attend the next
ECTP FA Materials
Meeting, 18th
Dec. in Brussels**

**Thank you for
your attention and for arranging this important workshop!!**

CBI, Swedish Cement and Concrete Research Institute

Experience of the utilisation of crushed rock as concrete aggregates in Göteborg

Governmental restrictions and uncertain future resources of natural sand have made the search for alternative materials an urgent matter in order to secure the future supply of concrete aggregates in the Göteborg region. A project was thus initiated to find a long term aggregate solution. Even though a few different alternatives have been assessed within the project the main focus has been to utilise manufactured sand from the Jehander pit in Källered, just south of Göteborg.

Preliminary results from laboratory concrete tests showed that the replacement of natural sand 0/8 with corresponding manufactured fraction resulted in a substantial increase of the water demand as well as reduced workability for the concrete. The differences were believed to be due to an increased amount of fines <0,063 mm in combination with poorer particle shapes of the crushed material.

Some alternative measures to improve the crushed sand were thus assessed and a production process that included the use of a so called VSI-crusher in combination with air classification was eventually selected. Full scale tests verified that VSI-crushing improved the particle shape. Another important effect of the selected crushing method was to even out the particle size distribution, see figure 1. It was further verified that the content of fines could be significantly reduced by air classification, see figure 2.

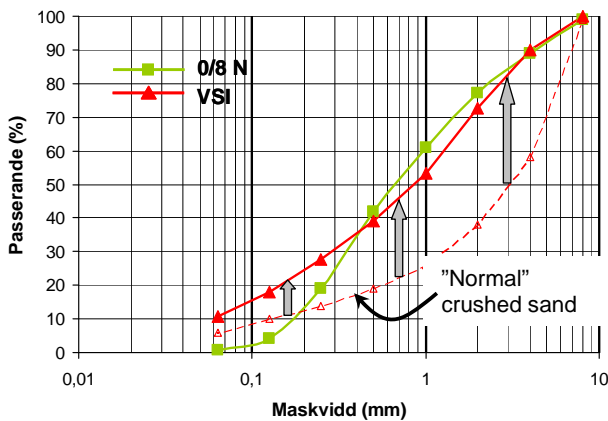

Figure 1

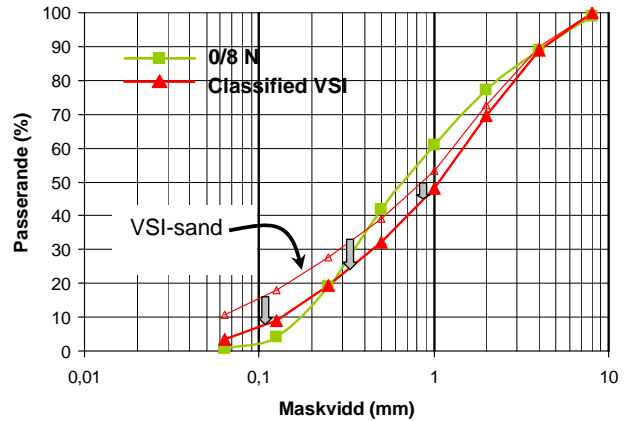

Figure 2

Results from laboratory and full scale concrete tests verified that the above described measures were sufficient to reduce the water demand to a level close to that of natural sand concrete. Moreover, the workability of the manufactured sand concrete was found to be satisfactory, see figure 3.

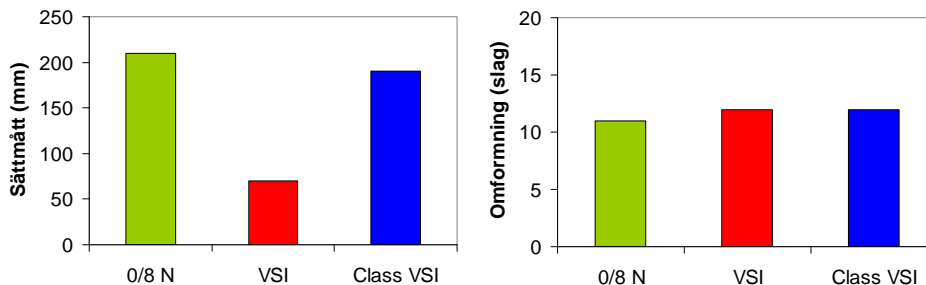

Figure 3 – Measured slump (left) and drops with Powers remolding test (right).

Manufactured sand in concrete

Experiences from laboratory and full scale tests in Göteborg

Stavanger 2008-10-29

Niklas Skoog
Sand & Grus AB Jehander

JEHANDER
HEIDELBERGCEMENT Group

Betongindustri
HEIDELBERGCEMENT Group

The Quarry in Kållerød



Slide 2 - 30-31.10.2008
Concrete with crushed rock aggregates – Jonas Carlswård

JEHANDER
HEIDELBERGCEMENT Group

Betongindustri
HEIDELBERGCEMENT Group

Background

- Uncertain future natural sand resources in Göteborg area
- Governmental restrictions
- Need to find alternative solution in Göteborg area
- A project initiated (Betongindustri/Jehander) to find a future solution
- Alternative types of aggregates have been assessed (e.g. danish sea sand and crushed rock from the Källered quarry)
- Conclusions from preliminary tests
 - Sea sand can be used to replace 0/8 sand (low water demand)
 - A drawback is that the supply is somewhat uncertain
 - Concrete with crushed rock aggregates (0/4) from Källered resulted in a substantial increase in water demand and poor workability
- Further processing required in order to utilize crushed rock from Källered

Slide 3 - 30-31.10.2008
Concrete with crushed rock aggregates – Jonas Carlswård

 HEIDELBERGCEMENT Group

 HEIDELBERGCEMENT Group

Main problems with manufactured sand

- Three main differences between crushed rock from Källered (cone crushed granite) and natural sand 0/8
 - Poor particle shape → Increased water demand
 - High amount of mica → Increased water demand
(~13% in fraction 0,125/0,25 mm)
 - Difference in size distribution → Increased water demand, poor workability

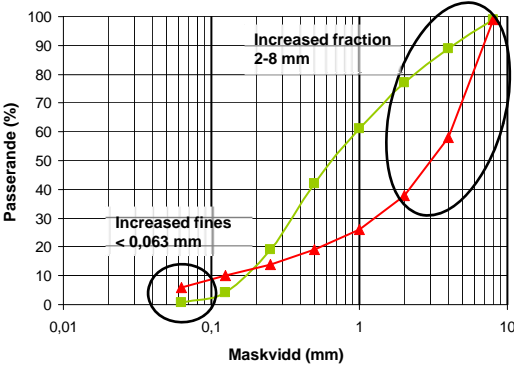



Maskvidd (mm)	Crushed Rock (Passerande %)	Natural Sand (Passerande %)
0,01	0	0
0,063	10	5
0,125	15	10
0,25	25	15
0,5	45	25
1,0	65	35
2,0	85	45
4,0	95	55
8,0	100	65
16,0	100	75
32,0	100	85
63,0	100	95
125,0	100	100

Concrete with crushed aggregates



Concrete with crushed rock aggregates – Jonas Carlswård

 HEIDELBERGCEMENT Group

 HEIDELBERGCEMENT Group

How to solve the problem?

- Modification of both particle shape and size distribution required
- Measures taken in the Göteborg project

1) VSI-crushing → Improves shape and evens out size distribution

Sandvik
Merlin
RP 107



F-shape

	0,125/0,25	0,25/0,5
Källered	0,46	0,48
Källered VSI	0,53	0,53

Slide 5 - 30-31.10.2008
Concrete with crushed rock aggregates – Jonas Carlswård

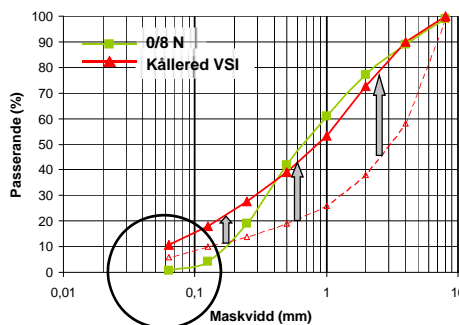

High content of fines

JEHANDER
HEIDELBERGCEMENT Group

Betongindustri
HEIDELBERGCEMENT Group

Solution to the problem

- Measures taken in the Göteborg project continued:

2) Air classification → Reduces amount of fines (and probably mica?)

Schmidt
USF 32

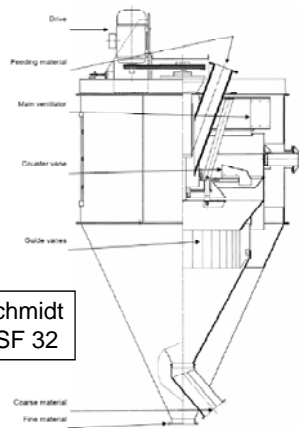

Slide 6 - 30-31.10.2008
Concrete with crushed rock aggregates – Jonas Carlswård

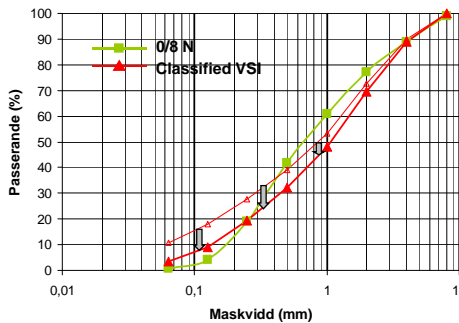

JEHANDER
HEIDELBERGCEMENT Group

Betongindustri
HEIDELBERGCEMENT Group

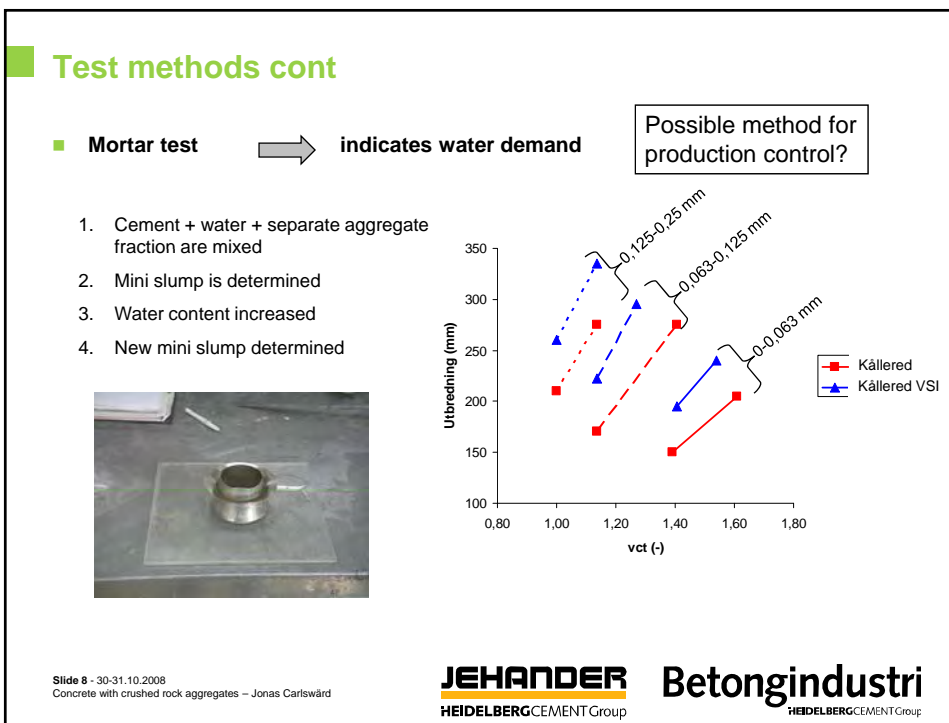
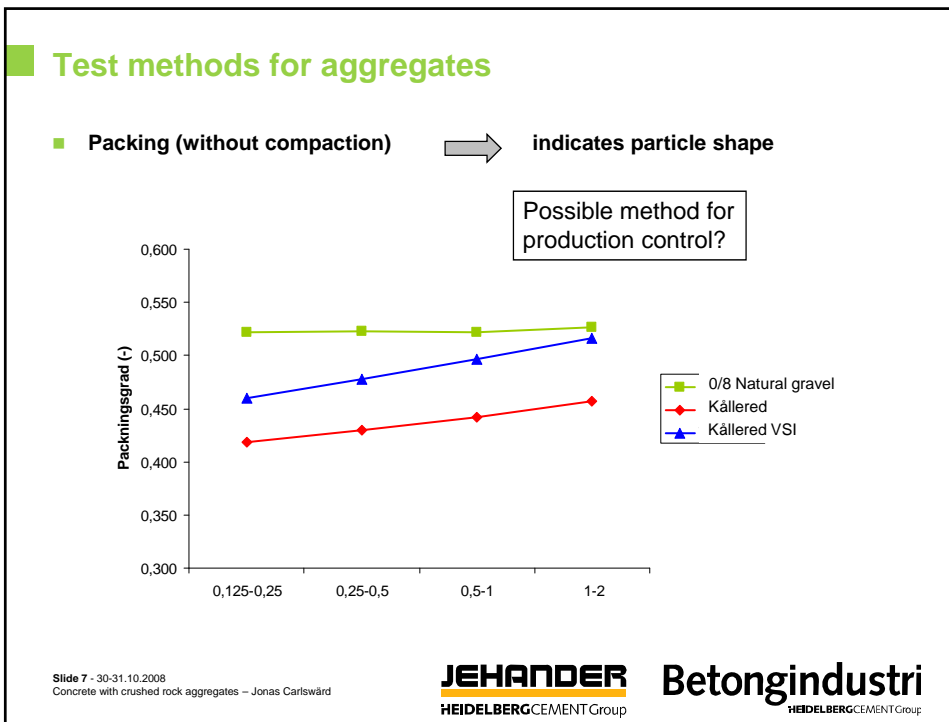

Concrete tests

Concrete with VSI-crushed and air classified aggregates

Btg C25/30 16 S3			
Material	0/8N	VSI	VSI+air
Cement	310 kg/m ³	310 kg/m ³	310 kg/m ³
Water	198 kg/m ³	198 kg/m ³	198 kg/m ³
w/c	0,64	0,64	0,64
Plasticizer	0,3 %	0,3 %	0,3 %
Slump	210 mm	70 mm	190 mm
Remoulding number	11	12	12
Add water		17 kg/m ³	
w/c		0,69	
Slump		135 mm	
Remoulding number		15	



Powers remoulding test

Slide 9 - 30-31.10.2008
Concrete with crushed rock aggregates – Jonas Carlswård

JEHANDER
HEIDELBERGCEMENT Group

Betongindustri
HEIDELBERGCEMENT Group

Full scale verification

Full scale test to verify pumpability, workability and other characteristics in the fresh and hardened state

C25/30 16 S3	
Material	
Cement Bygg	306 kg/m ³
Water	194 kg/m ³
S 56	0,45 %
w/c	0,63
Slump	200 mm
Slump _{45 min}	170 mm
Remoulding number	8 slag
Strength, 28d	36 MPa
Density	2360 kg/m ³



Slump 5 min



Slump 45 min



Slide 10 - 30-31.10.2008
Concrete with crushed rock aggregates – Jonas Carlswård

JEHANDER
HEIDELBERGCEMENT Group

Betongindustri
HEIDELBERGCEMENT Group

Conclusions

- We believe we have a concept for manufacturing sand from the quarry in Kållerød (VSI crusher + air classifier)

To go further we need:

■ **Requirement specification for manufactured sand :**

- Size distribution, shape, surface structure, mineral content (mica?)...
- Are the characteristics of 0/8 natural gravel also the optimum for manufactured sand?

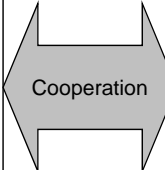

Cooperation

■ **Optimize a plant for manufactured sand:**

- Optimum input material, type and position (replace the cone crusher in the third crusher step?) and settings of the VSI-crusher?
- Optimum type, input material and settings of the air classifier?

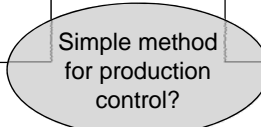

Simple method for production control?

Slide 11 - 30-31.10.2008
Concrete with crushed rock aggregates – Jonas Carlswård

JEHANDER
HEIDELBERGCEMENT Group

Betongindustri
HEIDELBERGCEMENT Group

EXPERIENCE WITH MANUFACTURED SANDS IN CANADA

Chris Rogers

Post Office Box 185, 161 Centre Street, Beeton, Ontario, Canada, L0G 1A0

E-mail rogers.chris@rogers.com

Phone 905-729-4768

ABSTRACT

Manufactured sands have been used in Canada for over 50 years. One of the first recorded instances was for the supply of concrete sand for parts of the St Lawrence Seaway in the 1950's. In this case there were no suitably graded sands locally available for lock or dam construction. Crusher screenings from local limestone quarries were washed and blended with locally available quartz rich raised beach sands. The beach sands were predominantly sized pass 600 μm . This ensured that there were adequate amounts (a minimum of 10 %) of material passing the 300 μm sieve so that adequate workability and concrete bleeding behaviour were achieved. Since the 1950's manufactured sands have been rarely used in hydraulic cement concrete. The reason is the generally unsuitable behaviour of such sands in concrete, the high cost of manufacture and the general availability of natural sands. Even in markets where natural sands are not locally available, natural sands will be brought into the market rather than adopt the use of locally made manufactured sands. Concrete sand probably only makes up about 10 % of the combined market for concrete and hot mix asphalt fine aggregate.

Manufactured sands have been extensively used in high performance asphalt concrete for the past 20 years. The angular shape of manufactured sands is necessary to provide the necessary resistance to deformation and rutting. High truck axle loads and high tire pressures have had a major impact on deformation rutting of asphalt concrete made with rounded and sub-angular natural sands. Generally manufactured sands for this application are made by blending approximately equal amounts of washed and unwashed crusher screenings. This results in a blended fine aggregate with an optimal amount of about 5 to 6 % material pass the 75 μm sieve. Such blending usually takes place at the asphalt plant in the feed system into the aggregate drier. Because much of the asphalt made today contains either crusher screenings blended with natural sand or manufactured sand, aggregate suppliers are seeing a relative decline in the demand for natural sands for asphalt.

Three interesting technical problems have arisen with the use of manufactured sands:

- Manufactured sands made of carbonate rocks (limestone and dolomite) are very susceptible to polishing in pavement surfaces compared with natural sands that normally contain large amounts of hard minerals such as quartz and feldspar. The Ontario Ministry of Transportation has a

requirement that manufactured sands for use in concrete pavement have an acid insoluble residue of 50%. This ensures that there are a sufficient amount of hard insoluble minerals such as quartz present that will resist polishing. Similar issues have also arisen with asphalt pavements and specifications restrict the use of carbonate rich manufactured sands on high traffic volume pavements.

- The measurement of the bulk relative density (specific gravity) of manufactured sands and crusher screenings using the ASTM C 128 test method may be in error when high fines ($- 75 \mu\text{m}$) are present in the sample. These differences in density can be large and can result in errors in calculating concrete and asphalt mixture characteristics. Sands with high fines content give abnormally high absorption and low bulk relative density values. This is caused by the fines promoting the formation of agglomerations of artificial aggregate particles as the sample is being stirred during the achievement of the saturated surface dry condition. These artificial aggregate particles have porosity in and of themselves and reach a saturated surface dry condition. The porosity (absorption) and bulk relative density measured is a combination of not only the individual grains in the fine aggregate but also of the artificial particles. A warning about this phenomenon has been placed in the ASTM and Canadian test methods.
- Large amounts of flakey particles in manufactured sands can result in poor asphalt concrete compaction or very poor concrete workability characteristics. At present there is no really suitable test to measure the presence of excessive amounts of flakey particles. The use of slotted sieves of suitable size can be used to recognize these particles. It is possible that the presence of excessive amounts of flakey particles is related to the type of crushers used to crush the coarse aggregate fraction. In any evaluation of the suitability of manufactured sand, the flakiness of the coarse fractions (1 to 5 mm) of sand should be assessed.

It is foreseen that the use of manufactured sands will gradually increase in Canada and North America. This will be driven by both the depletion of local sources of natural sand and the high cost of natural sand in certain markets and also because of the beneficial engineering properties of manufactured sands. The test methods that we have used to evaluate natural sands will need modification and new criteria and test methods will have to be adopted to properly evaluate the properties of these new materials.

Keywords: acid insoluble residue, aggregate, concrete, crusher screenings, density, flakey particles, hot mix asphalt, manufactured sand, particle shape, polishing, rutting, sand, testing,

Experience with Manufactured Sands in Canada

Chris Rogers
October 2008

Ministry of Transportation Ontario

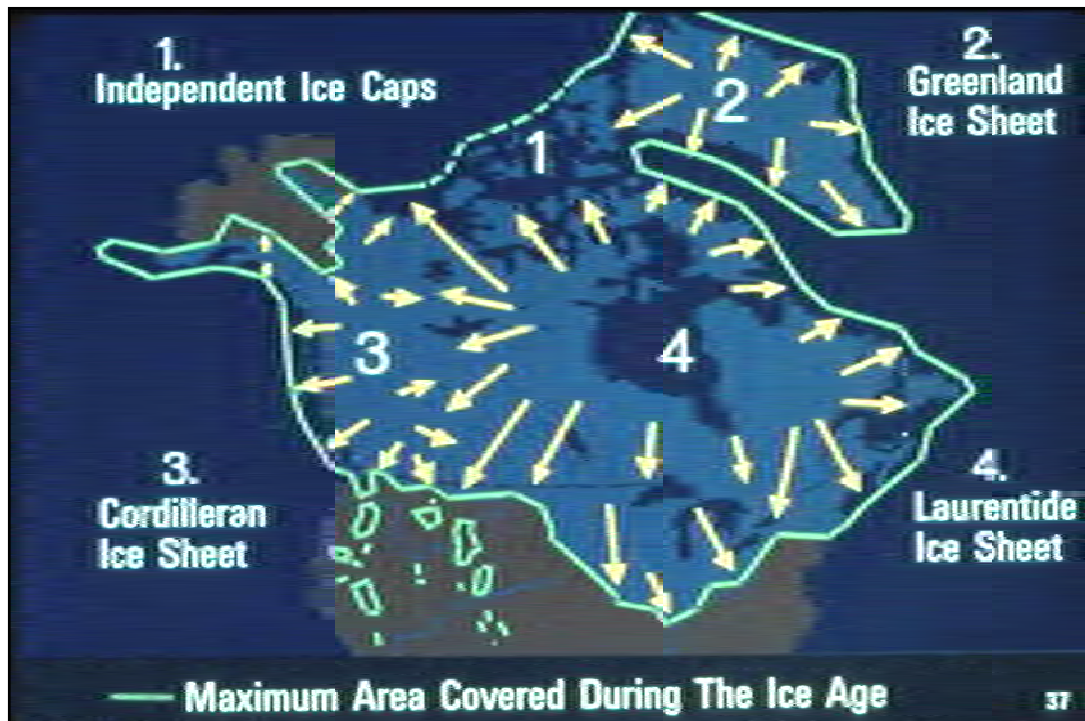

Manufactured sand – Concrete use

- Extensive sources of natural sand in NA. Concrete sand is a small % of all aggregates.
- Early use of Manufactured sand on St Lawrence Seaway c 1957 – limestone crusher sand with local quartz rich sand from raised beach (mainly finer than 600um).
- Little use of manufactured sand in concrete since. Relative cost and ease of transport has improved (highways, trucks).
- Niagara area, only one sand source (close to depleted) – natural sand is trucked in.
- Loss of beach sand on Caribbean Islands.

3

Ministry of Transportation Ontario



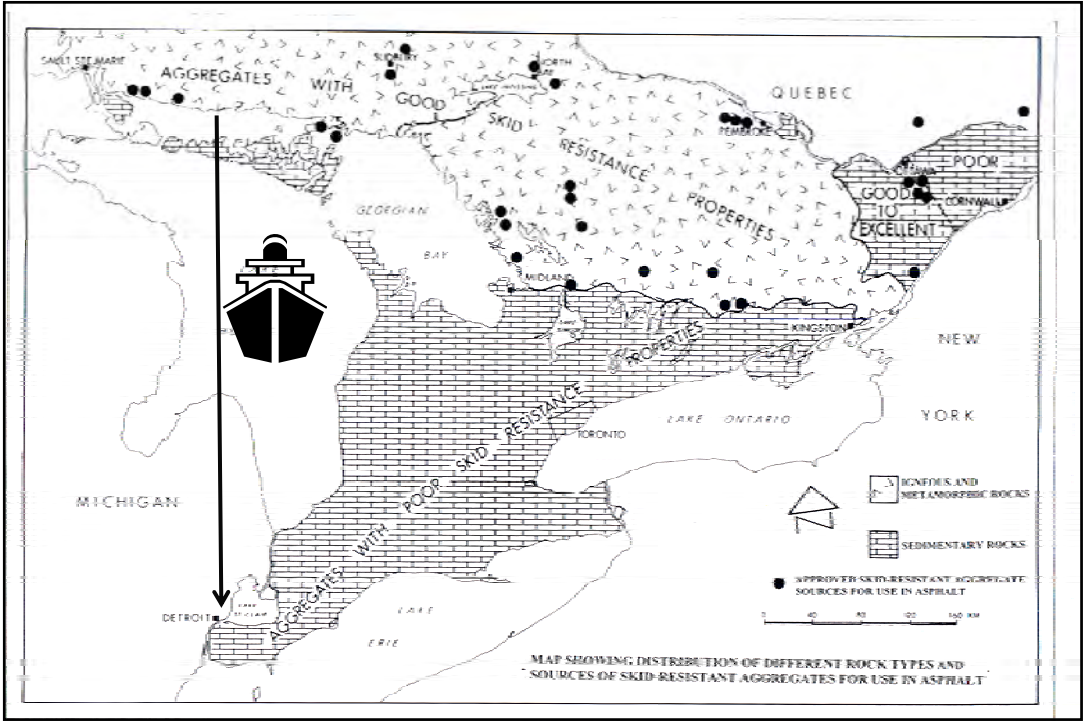



Manufactured sand – Asphalt use

- Extensive sources of natural sand in NA.
- Increased tire and axle weights of 1980's led to deformation rutting.
- Resulted in introduction of 'Super Pave' liquid asphalts and mix design process starting in mid-1990's.
- Substantially increased use of manufactured sand – crusher screenings (< 5mm).
- Typically two crusher screening products (washed and unwashed) mixed in cold feed bins at asphalt plant

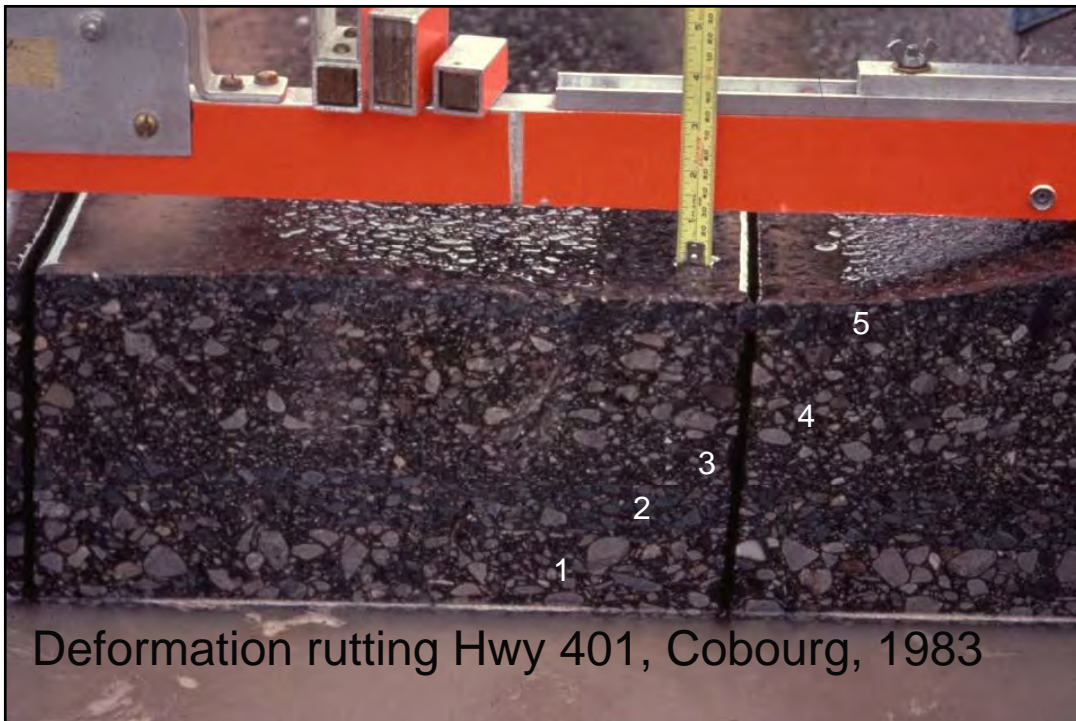

Superpave Aggregates

- Most North American Highway Agencies changed from Marshall Mix Design method to Superpave Mix Design method in early 2000's
 - Marshall– 45% stone, 45% sand, 10% Scr
 - S. Pave – 50 % stone, 25 % sand, 25% Scr
- S. Pave tends to result in reduction of natural sand use and imbalance of products in sand/gravel aggregate sources

Ministry of Transportation Ontario

Density testing problems

- There can be significant differences in bulk relative density when fine aggregate is tested with high fines ($-75 \mu\text{m}$) present in test sample.
- Differences in density can be large and cause big errors in calculating the VMA.
- In Kentucky, Kansas, Kentucky, Mississippi and Ontario led to contract disputes (use of payment based ERS involving the VMA).
- Study to investigate the effect and determine the cause.

12

Ministry of Transportation Ontario

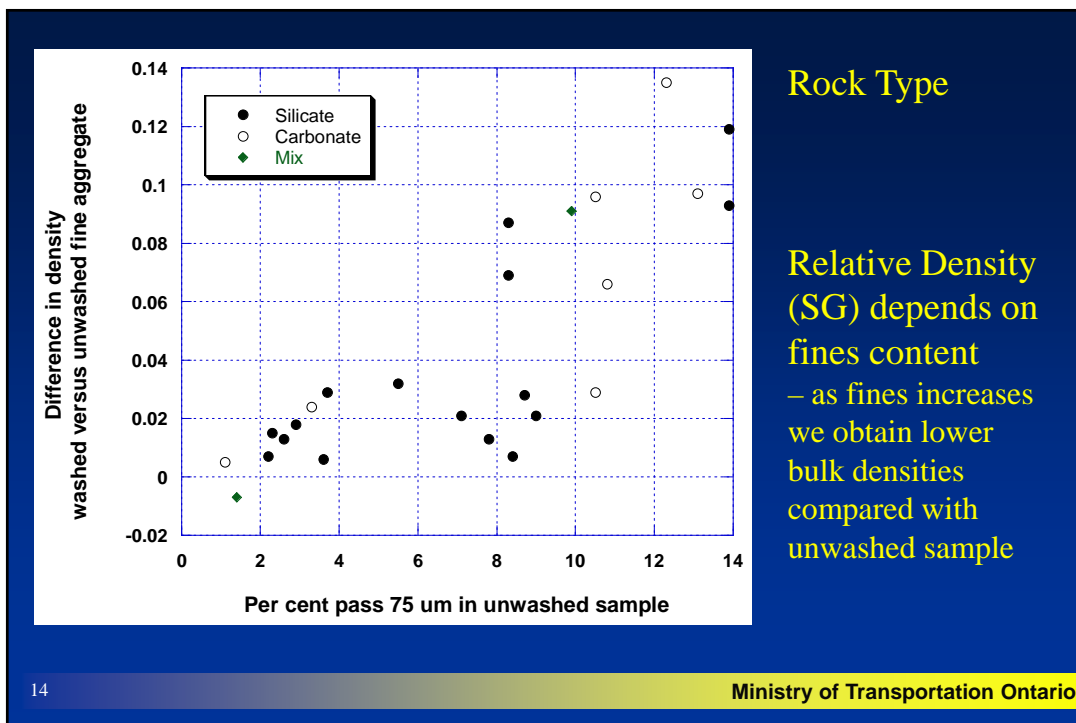
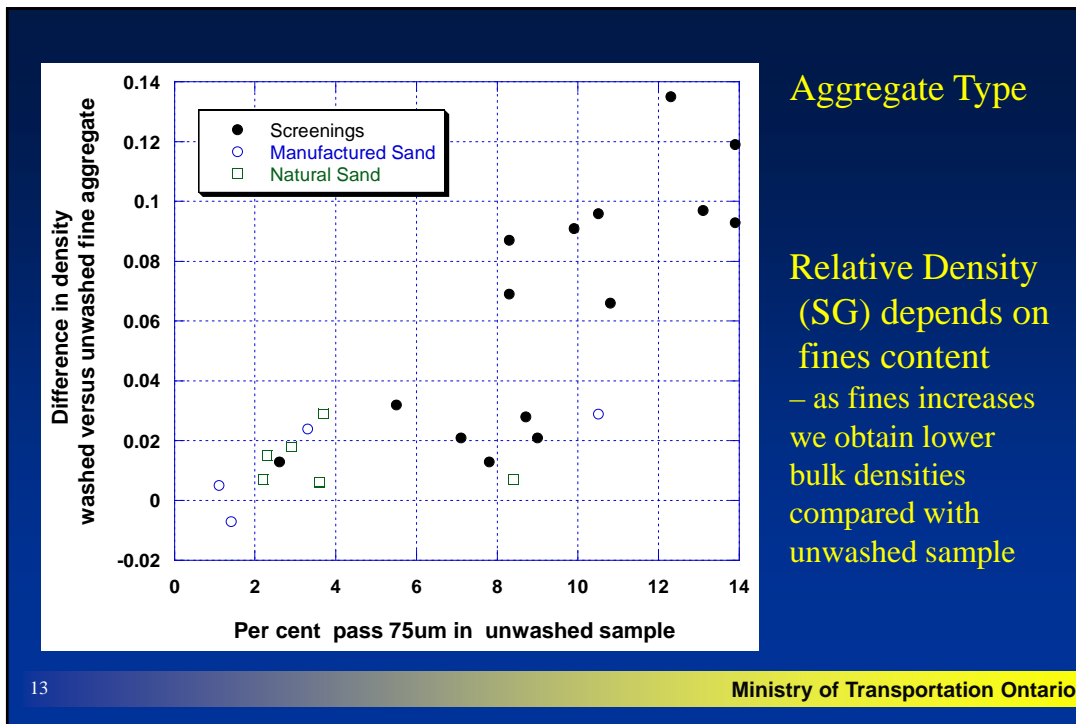

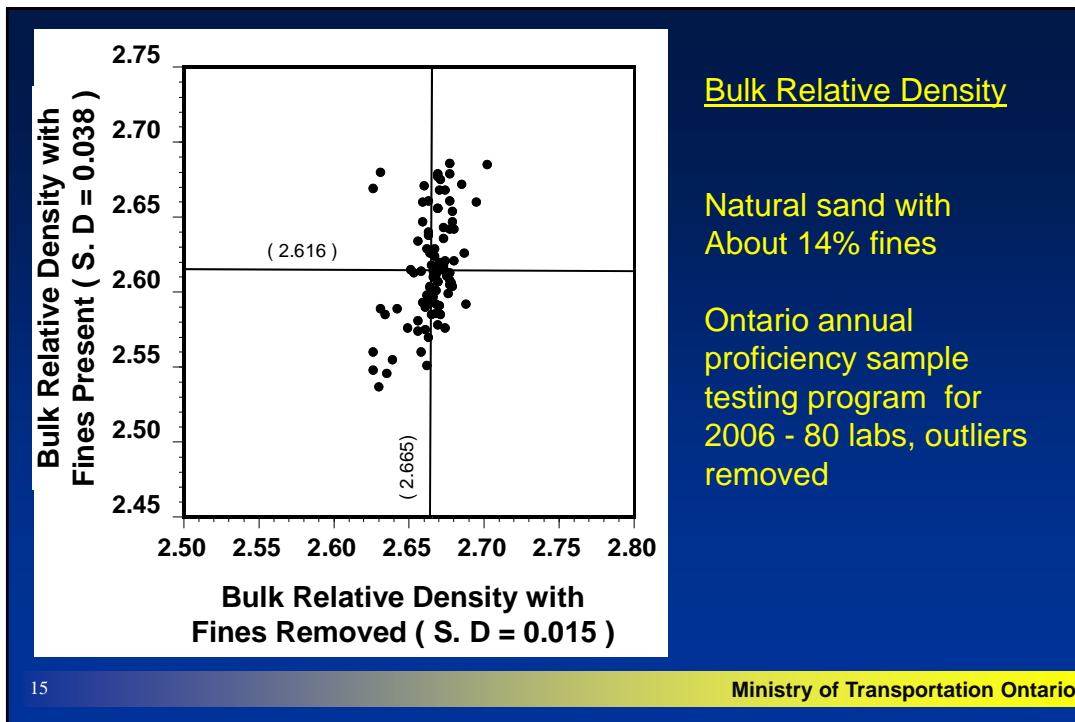

Effect of fines on density (SG)

- Effect seems to be most pronounced with manufactured sand or crusher screenings with > 6 or 7 % fines (-75 μm)
- Normally stone sand density is same as parent rock.
- Following the conventional ASTM C 128 or AASHTO T 84 methods, where fines are present in sample, nearly always results in a higher absorption and a lower bulk relative density compared with testing the same fine aggregate from which the fines are removed.

Limestone crushed sand, no fines. 0.74 % Absn, 2.639 RD



Limestone crushed sand , 11.5 % fines, 2.4 % Absn, 2.554 RD

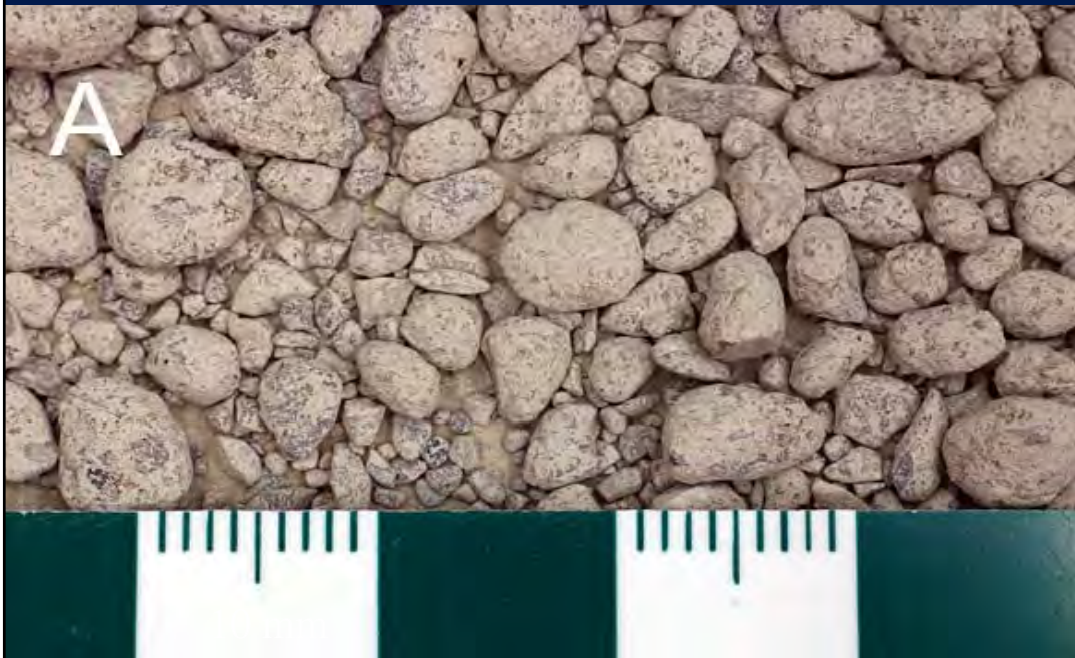

Limestone crushed sand, no fines, 0.74 % Absn, 2.639 RD



Limestone crushed sand , 11.5 % fines, 2.4 % Absn, 2.554 RD



Effect of fines

- Samples with fines built up a coating around the coarser particles at the SSD point caused by stirring during drying
 - Density and absorption measured is that of these artificial particles
 - Samples without fines have no coating so at SSD point, density is that of the particle and density and absorption is that of rock particle
- Note: SSD = saturated surface dry condition

21

Ministry of Transportation Ontario

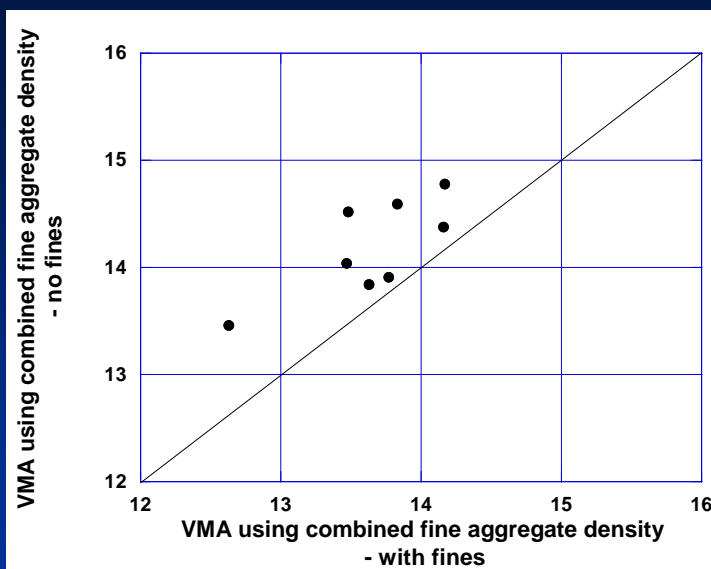

Effect of fines/
no fines
relative
density
determination
on
calculated
VMA of eight
asphalt
mixtures

22

Ministry of Transportation Ontario

Conclusions

- To properly measure the density of fine aggregate the fines should be removed from the sample by washing.
- Ontario and Kentucky (and others) in 1960's recognized this defect of the test and modified it so that fines were removed from sample prior to testing.
- This test was developed in the 1930's for concrete sands and at that time was not conceived of being used with fine aggregates with a high fines content.

23

Ministry of Transportation Ontario

APPENDIX TO ASTM C 128 (Non-Mandatory Information)

X1. POTENTIAL DIFFERENCES IN BULK RELATIVE DENSITY AND ABSORPTION DUE TO PRESENCE OF MATERIAL FINER THAN 75 μm

X1.1 It has been found that there may be significant differences in bulk relative density and absorption between fine aggregate samples tested with the material finer than 75 μm (No. 200) present and not present in the samples. Samples from which the material finer than 75 μm is not removed usually give a higher absorption and a lower bulk relative density compared to testing the same fine aggregate from which the material finer than 75 μm is removed following the procedures of Test Method C 117. Samples with material finer than 75 μm may build up a coating around the coarser fine aggregate particles during the surface drying process. The resultant relative density and absorption that is subsequently measured is that of the agglomerated and coated particles and not that of the parent material. The difference in absorption and relative density determined between samples from which the material finer than 75 μm have not been removed and samples from which the material finer than 75 μm have been removed depends on both the amount of the material finer than 75 μm present and the nature of the material. When the material finer than 75 μm is less than about 4% by mass, the difference in relative density between washed and unwashed samples is less than 0.03. When the material finer than 75 μm is greater than about 8% by mass, the difference in relative density obtained between washed and unwashed samples may be as great as 0.13. It has been found that the relative density determined on fine aggregate from which the material finer than 75 μm has been removed prior to testing more accurately reflects the relative density of the material.

X1.2 The material finer than 75 μm which is removed can be assumed to have a relative density that is the same of that of the fine aggregate. Alternatively, the relative density (specific gravity) of the material finer than 75 μm may be further evaluated using Test Method D 854, however, this test determines the apparent relative density and not the bulk relative density.

24

Ministry of Transportation Ontario



Diabase
Stone
Resistant
To polishing

12.5 mm SP mix with 40 % coarse aggregate (> 5mm)
Actual stone in surface was about 23% of area

25 Ministry of Transportation Ontario

Pavement friction problems

- Aggregate grading and gyratory compaction of superpave mixtures encourages high amounts in size 1 to 5 mm to maximize stability.
- This can result in immersion of polish resistant coarse aggregate (> 5mm) and loss of friction
- Solution is to specify polish resistant aggregate in size range 1- 5 mm - cost?

26

Ministry of Transportation Ontario



Diabase
Coarse
aggregate

Limestone manufactured sand polished and 40 vehicles lost control

27 Ministry of Transportation Ontario

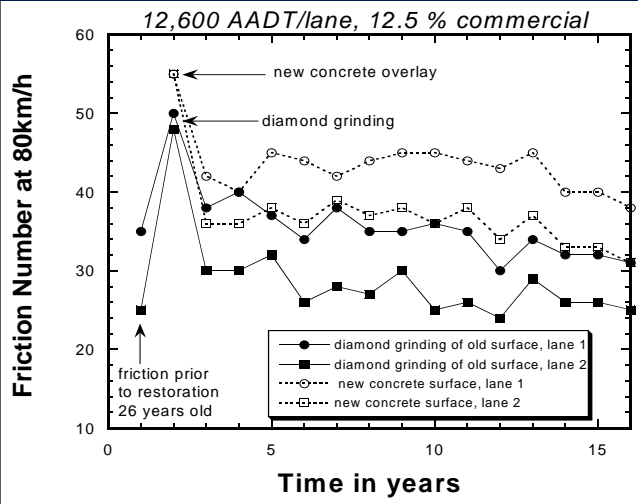

12,600 AADT/lane, 12.5 % commercial

Friction Number at 80km/h

Time in years

friction prior to restoration 26 years old

new concrete overlay

diamond grinding

● diamond grinding of old surface, lane 1
 ■ diamond grinding of old surface, lane 2
 ○ new concrete surface, lane 1
 □ new concrete surface, lane 2

Concrete pavement, Old Hwy 126, London

Ministry of Transportation Ontario

For concrete pavement surfaces - specifications in Ontario require a minimum 50% acid insoluble residue (i.e. Quartz or silicate sand) in manufactured sand. Michigan had problems In early 1950's when stone and sand from the same limestone source.

Conclusions – Manufactured sands

- Concrete
- Small market (<10% of overall sand market)
- Limited use in specific market areas – cost of natural sand
- Asphalt
- Larger market
- Increased use due to technical advantages
- Density measurement
- Polishing of carbonates in pavement surface
- Shape and effect on asphalt compaction and concrete workability – flakiness test
- Need to have new or modified test methods
- Understand crushers



Air Classification

A method to adjust fine aggregate gradation

Stavanger October 2008



Why Air Classification?



- **Increased market interest in manufactured sand to replace natural sand, which is a locally diminishing resource**



- **A growing need for our customers to find an alternative solution for removing fines (1-500 microns) from sand**



- **Increased awareness about disadvantages with traditional wet separation process, environmental and economical.**



Principles of Operation

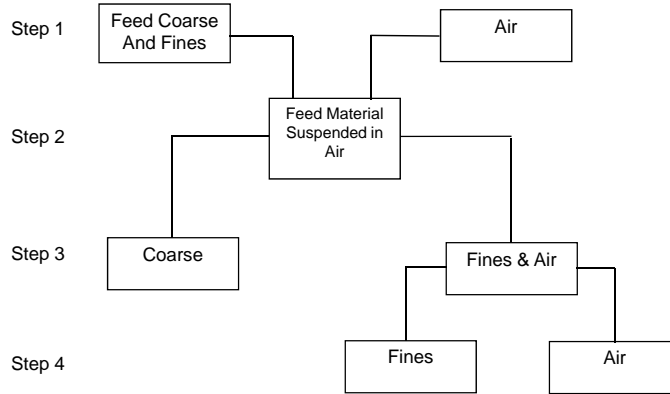

© Metso



Process schematic

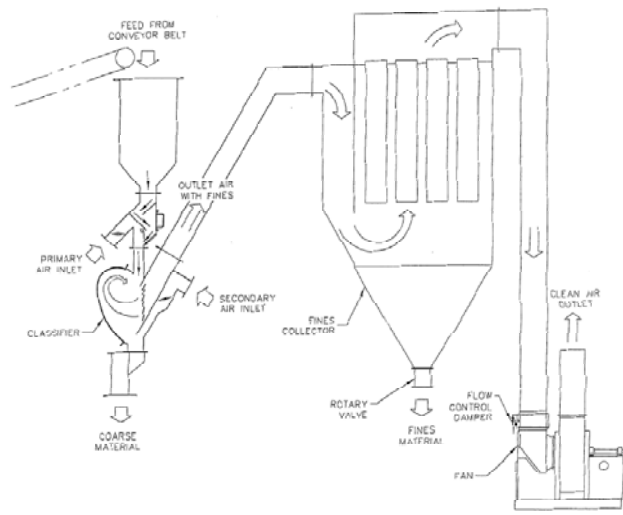

© Metso



Nordberg AC27 & AC30

Gravitational Inertial Classifier

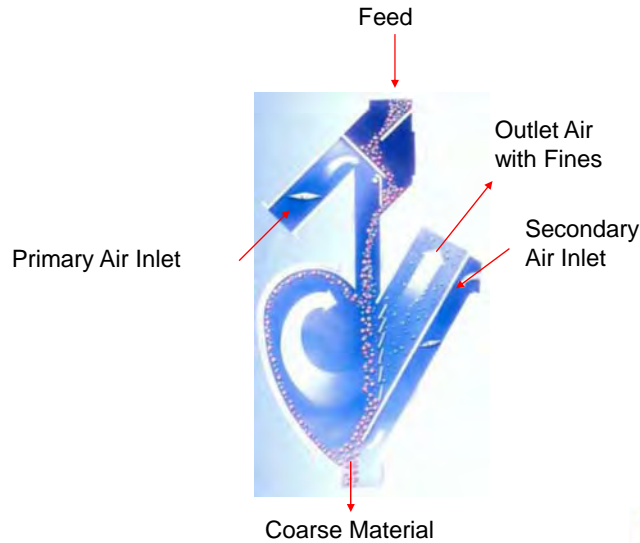

© Metso



The air classification process

Forces acting upon particles in the classifying chamber

Coarse particle

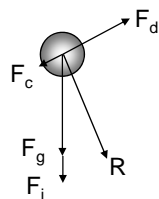

Fine particle

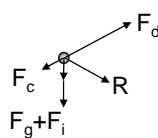

Near size particle

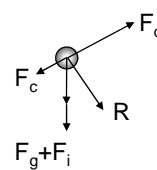

F_d = Air drag force

F_g = Gravitational force particle mass x g

F_i = Inertial drag force provided by the secondary air

F_c = Centrifugal force or the reactional force counteracting the air drag force

R = The resultant of forces acting on each particle in the classifying chamber

© Metso



The gravitational Inertial classification process

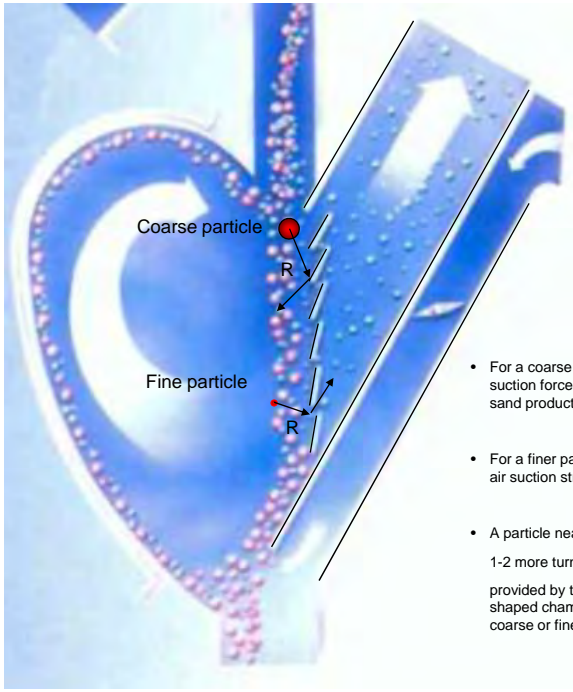

The diagram illustrates the internal structure of a classifier chamber. It shows a central vertical shaft where particles are fed. The chamber is designed to create an eddy current. A coarse particle (red dot) is shown falling towards the bottom, while a fine particle (pink dot) is shown being drawn into the air suction stream. Arrows labeled 'R' indicate the radial forces acting on the particles.

- For a coarse particle, gravity will be stronger than the air suction force and hence it will fall down into the coarse sand product.
- For a finer particle the resulting force will move it into the air suction stream and separate it out as fines.
- A particle near the designed cut point size may need 1-2 more turns in the eddy current provided by the secondary air entering the half-heart shaped chamber before it is directed either into the coarse or fine product.



The classifier chamber in real life



The photograph shows the interior of a classifier chamber. The walls are curved and made of metal. The floor is covered with a layer of sand. On the right side, there is a slatted structure that allows the air suction to draw the fine particles into the stream.



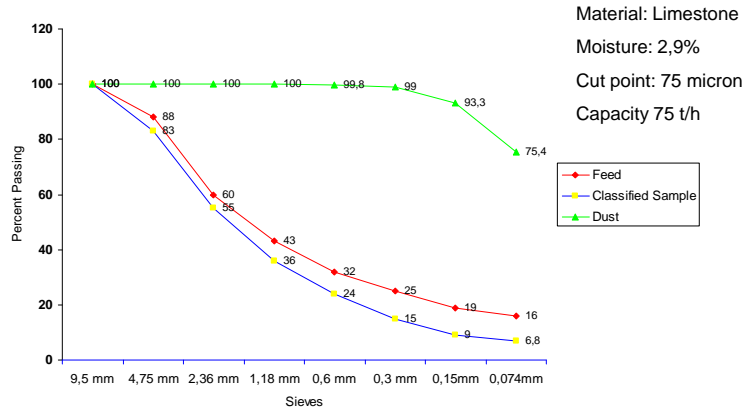

Gravitational Inertial Classifier classification example 1



© Metso

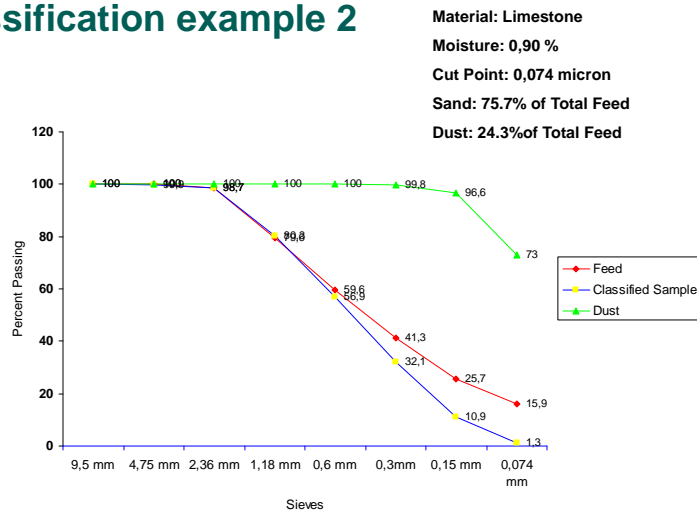

Gravitational Inertial Classifier classification example 2



© Metso



Centrifugal Classifiers

- **Nordberg AC1809**

- Designed to separate particles at cutpoints between 20 and 100 microns
- Best used as separate 2nd stage classification to further increase yield of coarse sand and additionally reduce particle top size in filler(dust) fraction.

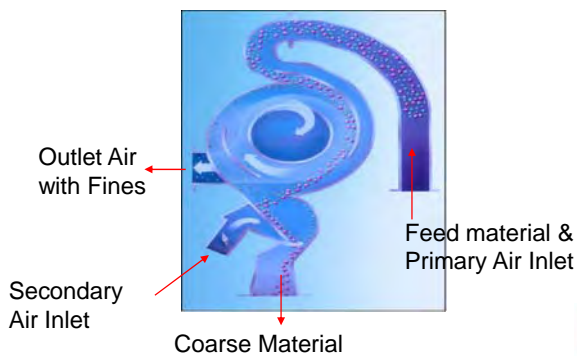

© Metso

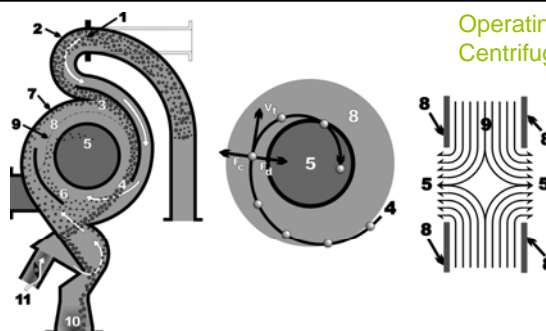

Operating principle
Centrifugal Classifier

Feed material and gas (usually air) enter the classifier inlet (1). The connecting duct for pneumatically conveyed material can be positioned from a vertical to a horizontal position to suit layout requirements (see dashed outline Figure 5). Gas inlet velocity is approximately 4,000 feet per minute, dependent upon feed material physical characteristics and cutpoint. Conveying velocity may be higher. For pneumatically fed, open air systems, the classifier inlet is flared and the feed dropped directly into the air stream.

The sharp bend (2) behind the inlet separates feed material from the gas stream by centrifugal action. The resultant "clean" gas stream passes behind a baffle plate (3) against which the feed material is sliding. The air stream then crosses the curtain of feed material (4) producing an intense scrubbing action which separates fine particles from the tailings, breaks up agglomerates and subjects all particles to an equal drag force.

Gravitational force immediately precipitates any very large particles to the bottom of the classifier. Intermediate and finer particles flow with the gas stream in a spiral path around the exhaust orifice (5) and are classified. The baffle plates (3, 6), the classifier outer casing (7), and side plates (8) form a flat, cylindrical classifying chamber (9) through which the gas stream spirals inwardly in a two-dimensional flow.

The flow path is controlled by the ratio of exhaust orifice diameter to the classifying chamber diameter and the amount of secondary air introduced at the bottom of the unit (11). Customers' varying cutpoint requirements are met by regulating secondary air flow.



2 stage Fixed Plant – Norway

- 60tph of minus 2mm.
- Moisture 2%.



© Metso



2 stage Fixed Plant – Norway

Gravitational Inertial Classifier
Cutting @ 0.50mm

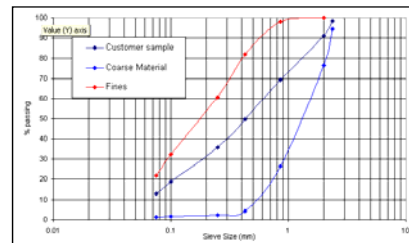

Centrifugal Classifier
Cutting @ 0.063mm

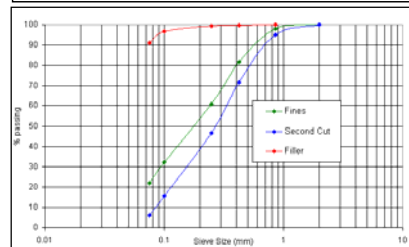

© Metso



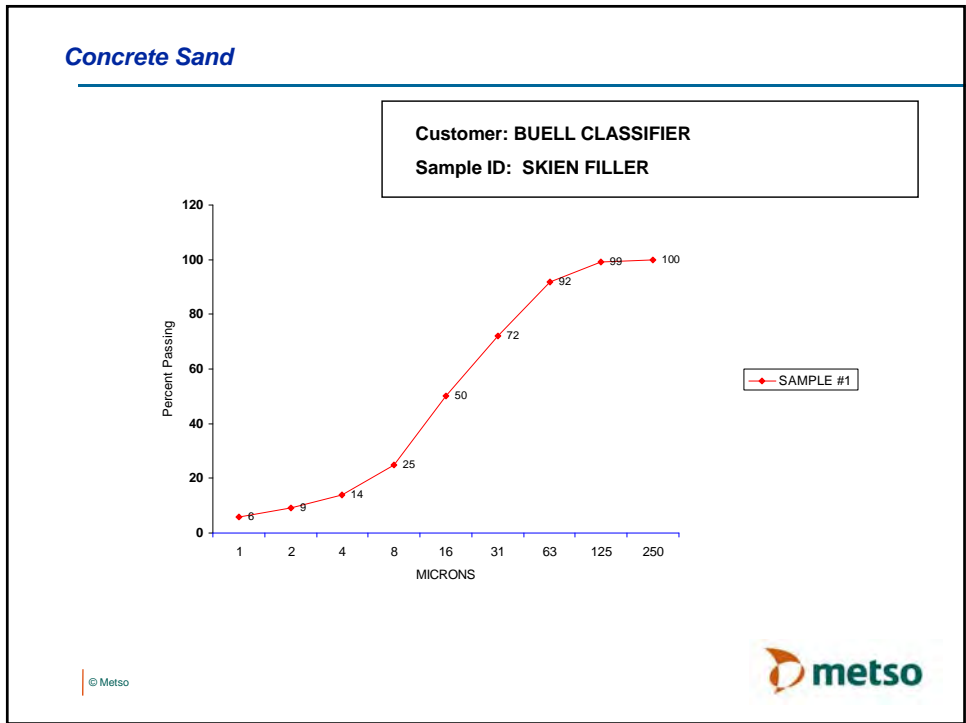
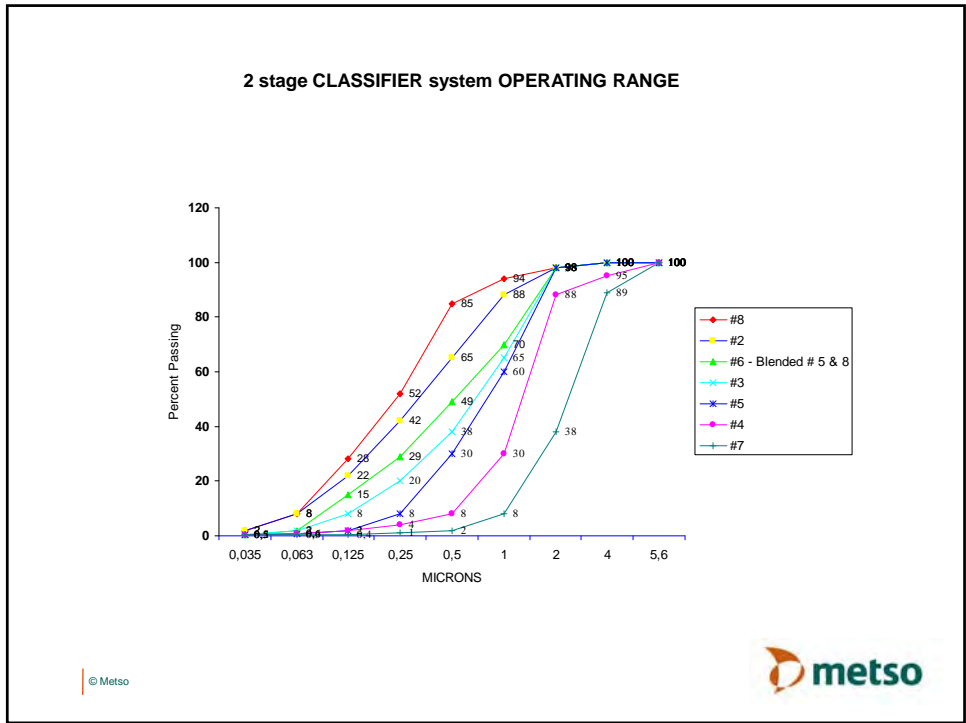

Gravitational Inertial classifier selecting correct wear lining

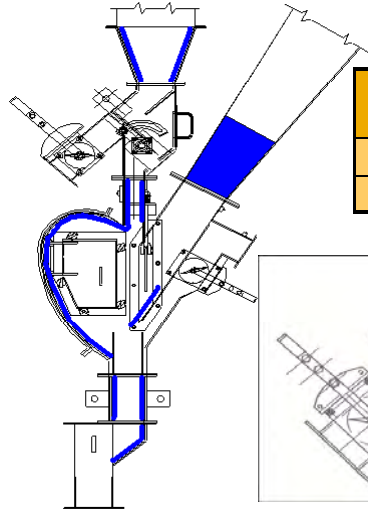

Classified material Abrasiveness	Lining Material (marked in blue)
Non Abrasive	Hardened steel plate
Abrasive (e.g. granite)	Ceramic tiles



Sandvik Sand

SANDVIK

Per Hedvall

General Manager Process Technology
 Rock Excavating and Processing Expertise
Sandvik Mining and Construction



Imagine

- The year is 2084
- All natural sand production has stopped Globally
- There are only a few options left

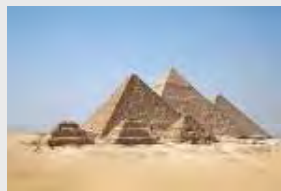

Hi I'm Per

- Born 1949 => **59 years young**
- Manager of the Rock Excavating and Processing Expertise department at SMC.
- REPE stands on four legs
 - Process support
 - Information support
 - EaT support
 - Process developments
- Worked within process technology for the last 35 years.



The Process Technology Manufactured sand

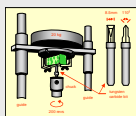
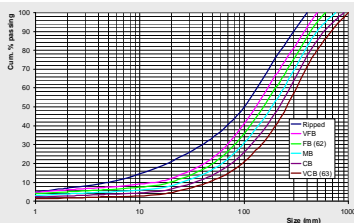

Pilot manufacturing of sand CV crushing

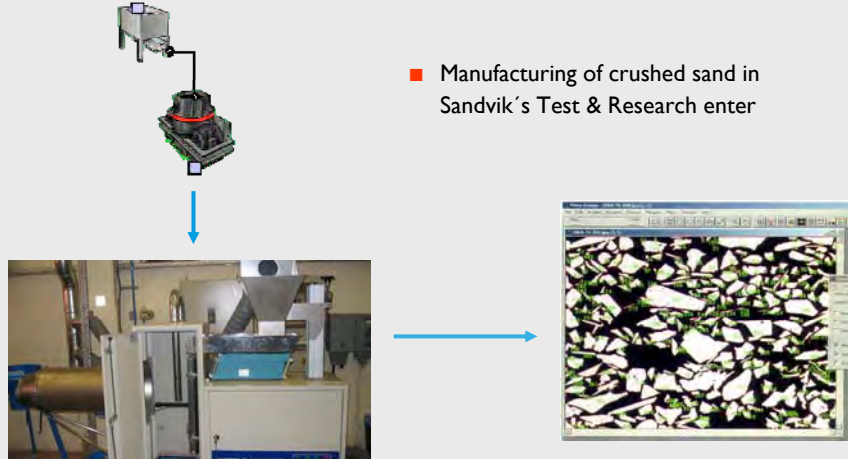

Crushing sand Comparison of CH, CS and CV crusher

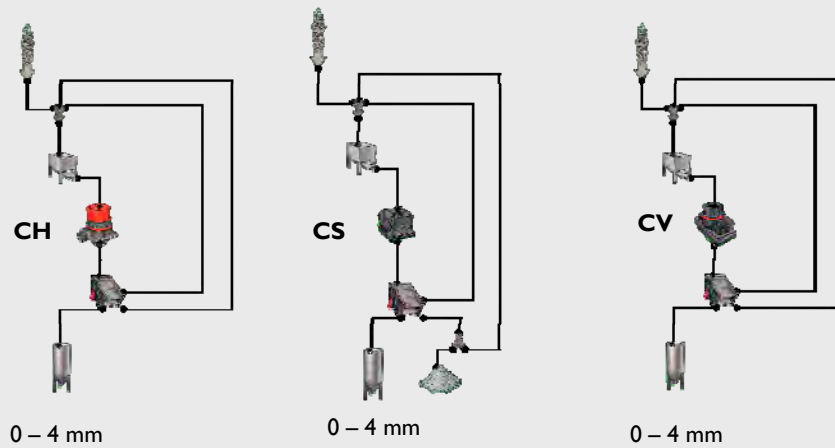

Crushing sand Feed materials

- Pre-crushed Limestone, Impact Work Index of 12.3 and Abrasion Index of 0.009.
- Pre-crushed Granite, Impact Work Index of 15.6 and Abrasion Index of 0.45.
- Pre-crushed Basalt, Impact Work Index of 21.9 and Abrasion Index of 0.24.

Material	WI	AI
Basalt	15 – 25	0.1 – 0.3
Diabase	14 – 22	0.1 – 0.4
Diorite	15 – 23	0.1 – 0.5
Gabbro	19 – 26	0.3 – 0.6
Gneiss	12 – 20	0.3 – 0.6
Granite	11 – 21	0.3 – 0.7
Limestone	10 – 16	0.001 – 0.2
Quartzite	11 – 19	0.6 – 0.9

Crushing sand Full-scale tests with CH crusher

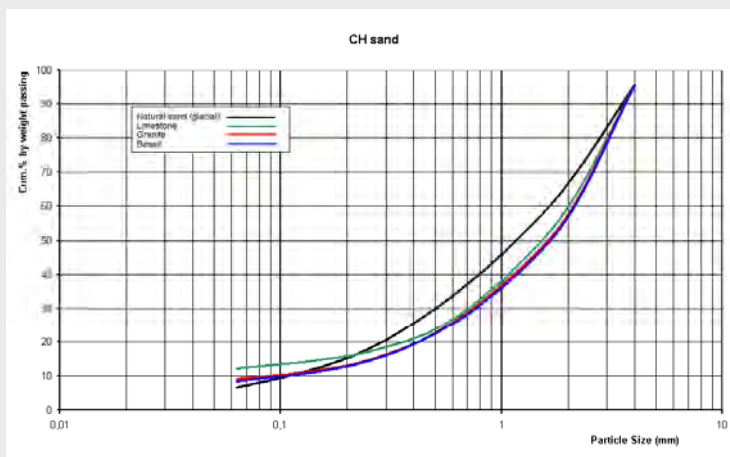

Crushing sand Full-scale tests with CS crusher

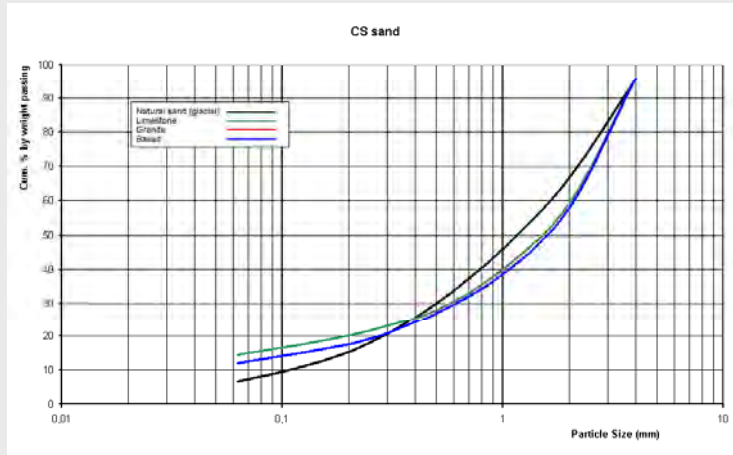

Crushing sand Full-scale tests with CV crusher

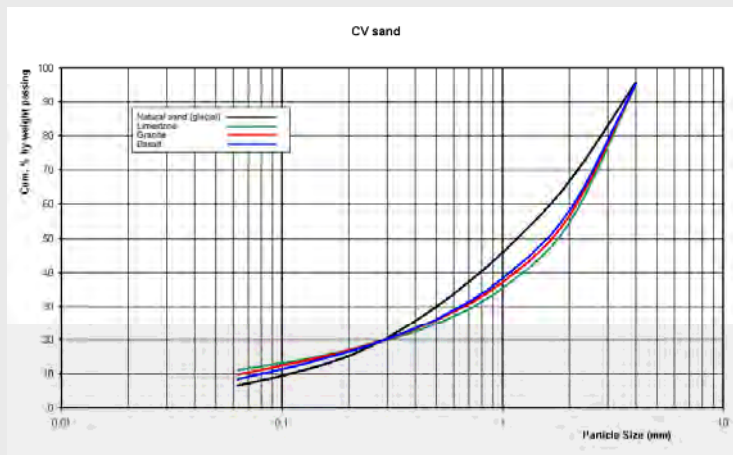

Crushing sand Shape in 0.063 – 0.125 mm



Natural sand



CV



CH



Sand particles bound for Concrete Shape ?



Sand particles bound for Concrete Ratio -- Area/Volume

Shape	Size (mm)			Surface Area (A)	Volume (W)	A/W
	l	w	t			
Round	4	4	4	50	100	0,5
	1	1	1	3,14	1,57	2
	0,1	0,1	0,1	0,031	0,002	20
Cub	4,7	4,7	4,7	129	100	1,3
	1,16	1,16	1,16	8,11	1,57	5,2
	0,116	0,116	0,116	0,082	0,002	51,6
Rec	3,2	3,2	9,7	146	100	1,5
	0,81	0,81	2,42	12,99	1,57	5,8
	0,080	0,080	0,242	0,129	0,002	57,9



Pilot manufacturing of sand Dedusting



Dedusting of crushed sand (1) Full-scale test

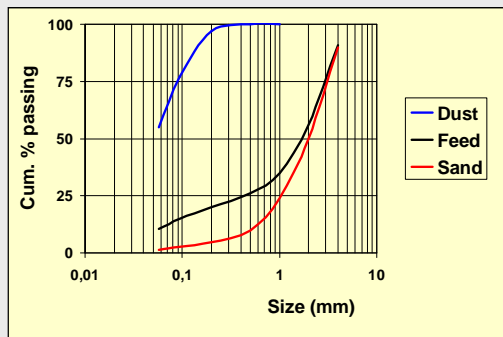

Dedusting of crushed sand (2) Full-scale test

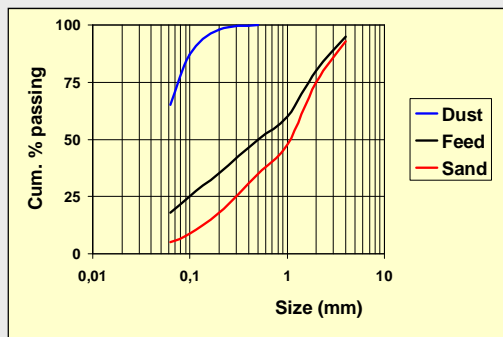

George Fensome
+ 44 773 312 0472



Natural sand will be a limit resource in the future.

but

The manufactured sand must be as good as or better than Natural sand.

The Beginning of the new Era



**Welcome to the future,
already today !!!**

An ostrich with its head in the sand is just as blind to disaster”

THE DEVELOPMENT OF CRUSHED SAND IN JAPAN
AND THE DIRECTION OF OUR RESEARCH

I. HISTORY OF FINE AGGREGATE USE AND DEVELOPMENT:

Japan was totally devastated as a result of World War II, with extensive destruction of buildings and infrastructure. However, we immediately started the reconstruction of the Nation, and that led to the first economic boom in around 1955. The consumption of concrete and fine aggregate dramatically increased, and reached its first peak when we had the Tokyo Olympic Games in 1964.

Initially, we mainly used river sand as a fine aggregate, but that caused many critical problems including the collapse of bridges and other structures. The use of river sand was therefore restricted, even though the demand for fine aggregate kept on increasing. Instead, we used pit sand and sea-dredged sand, and crushed sand was also slowly introduced. For environmental reasons, the use of sea sand began to be restricted in many places from around 1990, and the development of sand manufacture from crushed rock became inevitable.

2. THE CURRENT SITUATION IN CRUSHED SAND MANUFACTURE IN JAPAN.

Initially we used wet systems; more recently dry sand production has been recognized as advantageous.

Consideration of advantages and disadvantages of the both of wet system and dry system, and the reputation of both in Japan.

3. TECHNICAL AND COMMERCIAL EXPLANATION OF V7 DRY SAND MAKING SYSTEM:

Explanation of V7 technology, and the comparison of V7 sand with natural sand.

4. THE QUESTION OF FILLER:

Crushing rock to make sand unavoidably produces filler (normally considered to be all material $<75\mu\text{m}$), which is becoming a critical problem in Japanese applications.

Explanation of our current research into the advantageous use of filler.

5. COMMERCIAL CONSIDERATIONS IN SAND PRODUCTION.

Analysis of suitability and economic efficiency of available technology

P-1

Manufactured Sand-Workshop
Stavanger, Norway – Oct 30th and 31st, 2008

Kemco Dry Sand-Making System V7
<To turn surplus crusher dust into premium sand>

Kotobuki Engineering &
Manufacturing Co.,Ltd.
Japan



P-2

Kemco presentation

**HOW CRUSHED SAND WAS DEVELOPED IN JAPAN
AND WHAT ARE WE DOING NOW - 5 MAIN POINTS:**

- 1. History of the use of fine aggregate and the current situation in Japan.**
- 2 . The current situation of crushed sand making machines in Japan.**
- 3 . Technical and commercial explanation of V7 dry sand making system .**
- 4 . The filler problem .**
- 5 . What is commercially most preferable sand?**

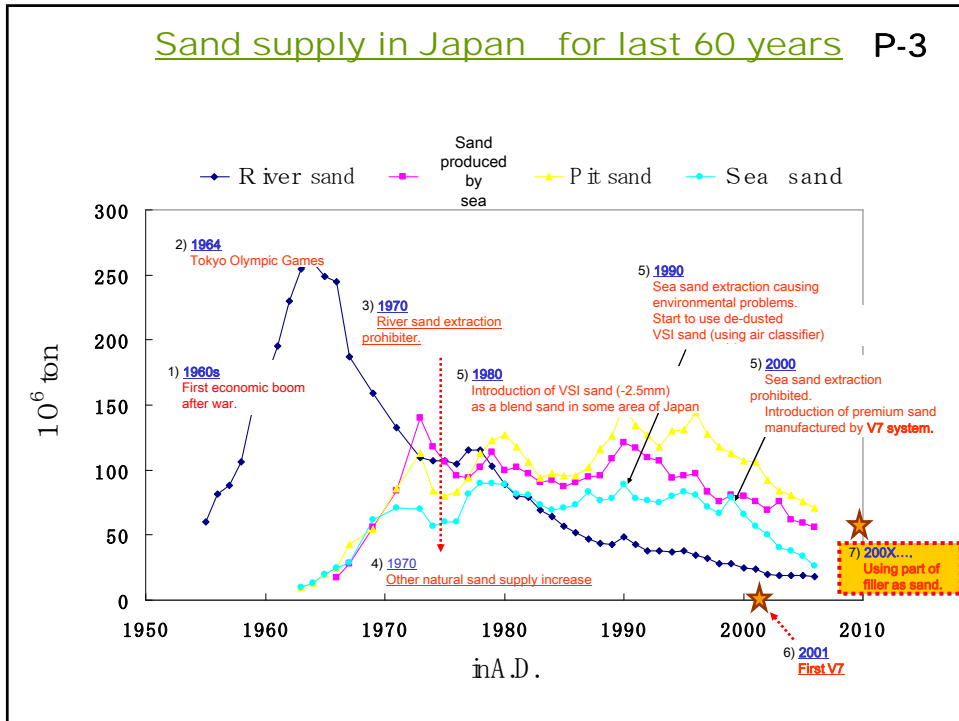

Extraction of sea sand causes the serious harm to the marine environment => 1990s P-4

Sea water gets turbid through sand extraction.

20m of depth of sand was extracted

A dredger extracting sea sand..

Map labels: 忠海, 幸崎, 大久野島, 大久野島中央, 忠海採取許可区域, 幸崎採取許可区域, 大久野島中央からの距離 (km).
 Legend: 忠海採取許可区域 (0.5km以内), 幸崎採取許可区域 (0.5km以内), 海深103号昭和38年11月による水深, 本調査結果 (平成10年度).
 Diagram labels: 海底断面図, 水深 (m), 20m, 消失した砂利層, 現状海底面.

The bottom of sea from which sand was all extracted. =>1990s

P-5



Well-known pictures published in the newspapers, triggering restriction of sea sand extraction in Japan.

Current and future availability of sand in Japan
Segment by segment

P-6

Options	Current situation	Future availability
River sand	Getting short	x
Sea sand	Getting short	x
Pit sand	Decreasing	△Limited volume
Slag	Very limited area and volume	△Limited volume
Import from China	China banned sand export in May, 2006.(Natural sand supply in China is also getting short)	x
Crushed sand	Increasing	⊙

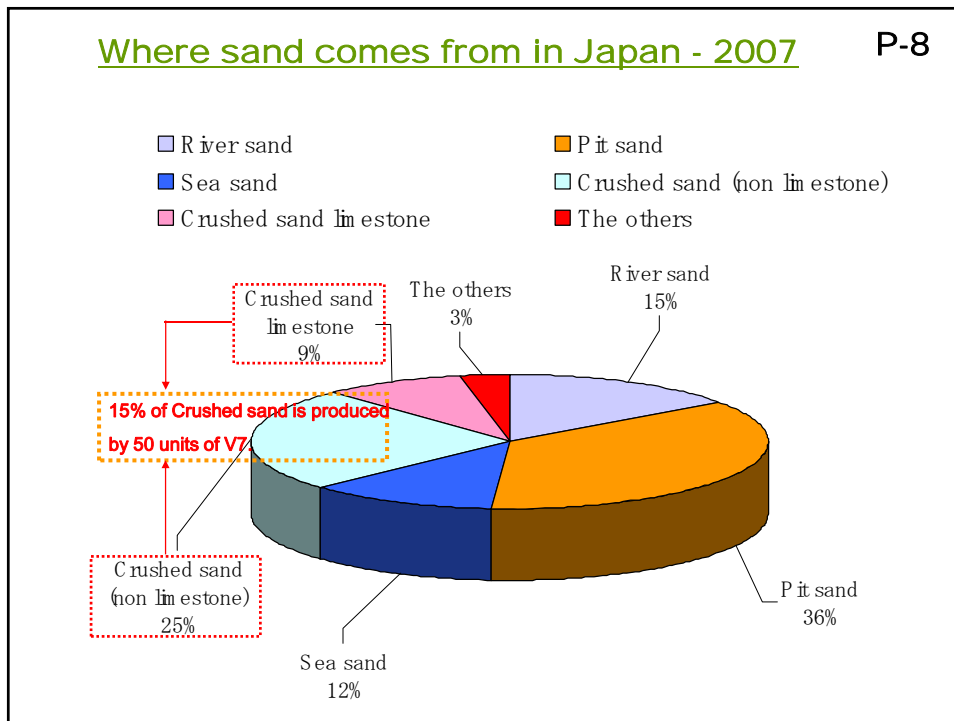
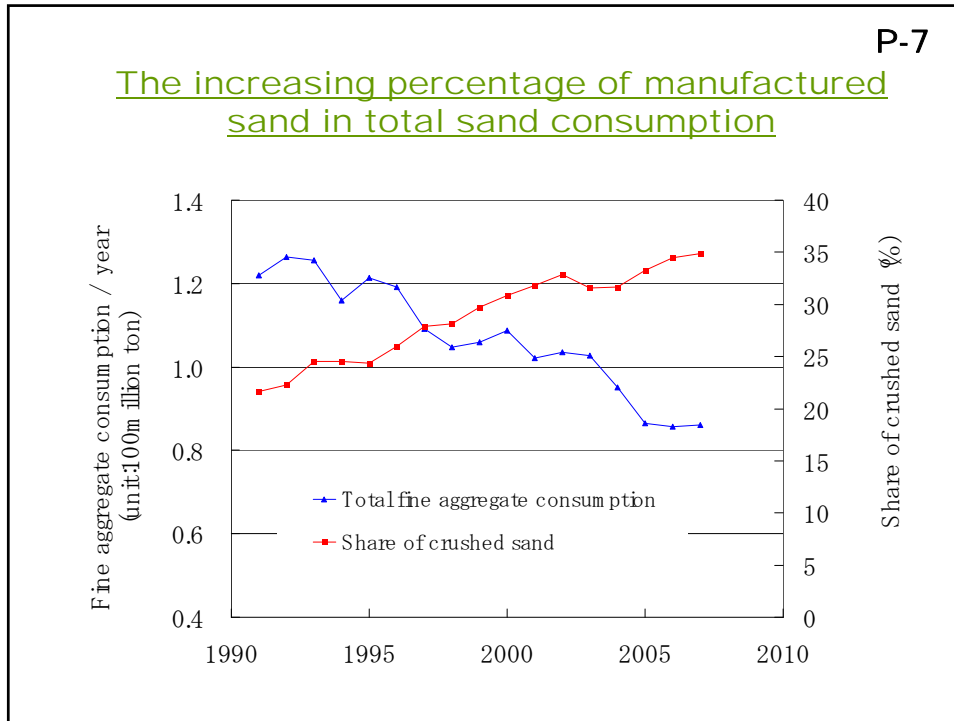

Kemco presentation P-9

**HOW CRUSHED SAND WAS DEVELOPED IN JAPAN
AND WHAT ARE WE DOING NOW - 5 MAIN POINTS:**

1. **History of the use of fine aggregate and the current situation in Japan.**
2. **The current situation of crushed sand making machines in Japan.**
3. **Technical and commercial explanation of V7 dry sand making system .**
4. **The filler problem .**
5. **What is commercially most preferable sand?**

Dry system vs. wet system P-10

	Dry Type (V7)	Wet Type (Ball Mill)
Sand making system	US\$1,000,000	US\$1,000,000
Sand making system-power arrangement	190,000	160,000
Sand making system-foundation	80,000	150,000
Wastewater disposal system	0	800,000
Wastewater disposal system-foundation	0	200,000
Cake disposal system	0	500,000
Total	US\$1,270,000	US\$2,810,000

Running cost	5 (US\$/t)	10 (US\$/t)
Required space	700m ² (20m×35m)	3200m ² (40m×80m)

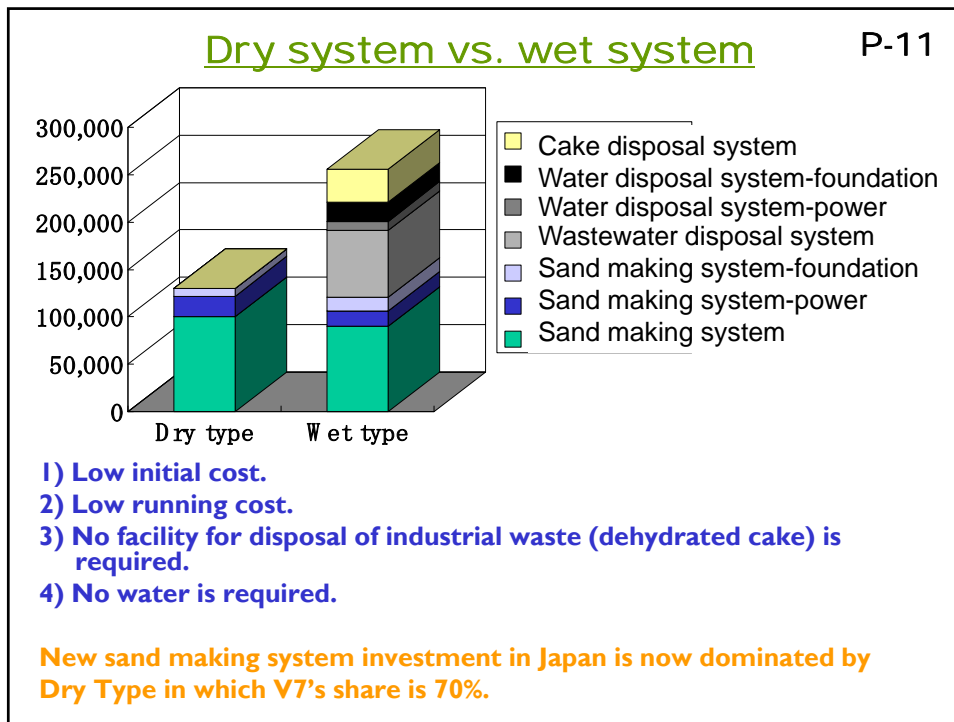

V7 vs. conventional sand making system P-12

Item	V7 Dry Sand-Making System	Roller Mill	Cage Mill	Rod Mill	Descriptions
Structure cutaway view					
Plant flow					
Grading control mechanism	By the combination of advance VSI and air screen.	Grading control is difficult	By an adjustment of screen and cage r.p.m. (inverter).	By changing number of rods and screen	
FM controllable range	F M 2.6 - 3.0	F M 3.0 - 3.2	F M 2.8 - 3.0	F M 2.6 - 3.0	
Gradation control	1) Can select the required grading. 2) Stable grading 3) Ideal grading	Insufficient 0.3 mm size range and excessive 2.5 - 1.2 mm size rang and filler.	Insufficient 0.3 mm size range and excessive 2.5 - 1.2 mm size size rang and filler.	Moderate	
Solid content (2.5-1.2 mm)	5 7.5 - 5 9 %	5 6.5 - 5 8.5 %	5 5 - 5 7 %	5 3 - 5 4 %	
Running cost	1 . 0	1 . 2	1 . 1	2 . 0	
Initial cost	1 . 0	1 . 6	1 . 3	1 . 1	
Maintenance	Easy	Difficult	Difficult	Difficult	
General statement	To produce premium sand which can be used as unblended sand. Excellent grain shape and ideal grading.	Grain shape is good. Grading control is inadequate.	Grain shape is good. Grading control is inadequate.	Bad grain shape.	

Using slag as sand

P-13

To produce sand by feeding slag from blast furnace and incineration plant.

1. 6-8% of moisture content in the feed generates excessive build-up in the crushing chamber.
(See "5 minutes" picture)
2. Vibrator helps to reduce the build-up to satisfactory level.
(See "2 hours" picture)
3. Continuous operation.



Kemco presentation

P-14

**HOW CRUSHED SAND WAS DEVELOPED IN JAPAN
AND WHAT ARE WE DOING NOW - 5 MAIN POINTS:**

1. **History of the use of fine aggregate and the current situation in Japan.**
2. **The current situation of crushed sand making machines in Japan.**
3. **Technical and commercial explanation of V7 dry sand making system .**
4. **The filler problem .**
5. **What is commercially most preferable sand?**

Kemco's criteria for manufactured sand system P-15

- **Marketable Sand Product**
- **Equivalent to natural sand**
- **Stable grading for non-blending sand**
- **Zero dust emissions**
- **Automatic operation**

Kemco V7 dry sand making system P-16

The image shows a complex industrial structure for sand production. It features a central vertical column labeled 'U S 7' surrounded by various conveyor belts, a dust collector at the top, a filler tank on the left, and a blower on the right. The system is supported by a network of steel beams and ladders.

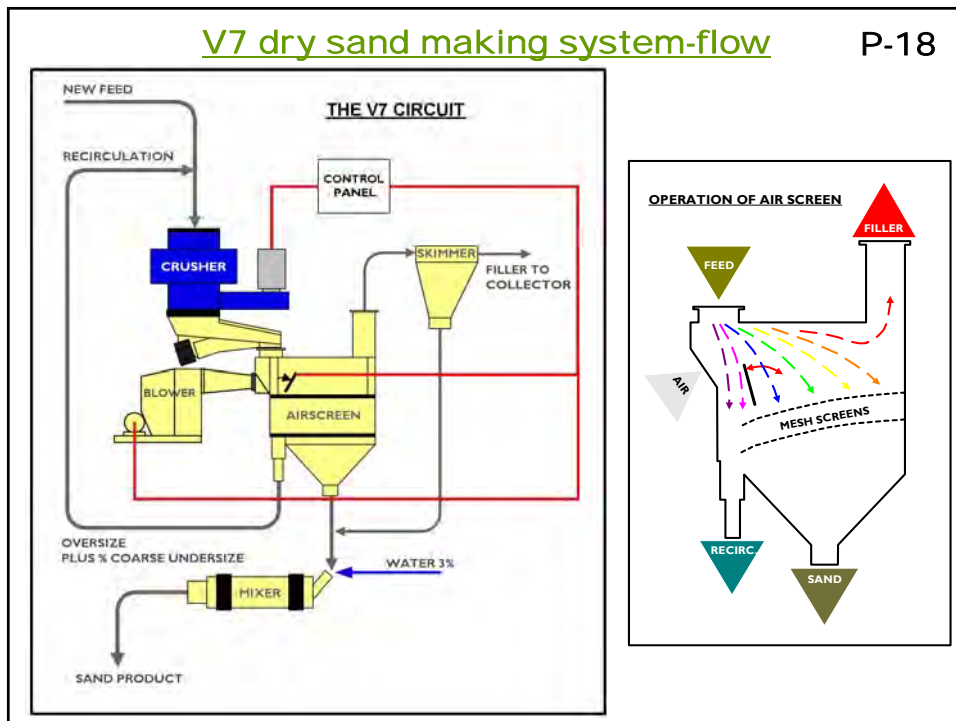
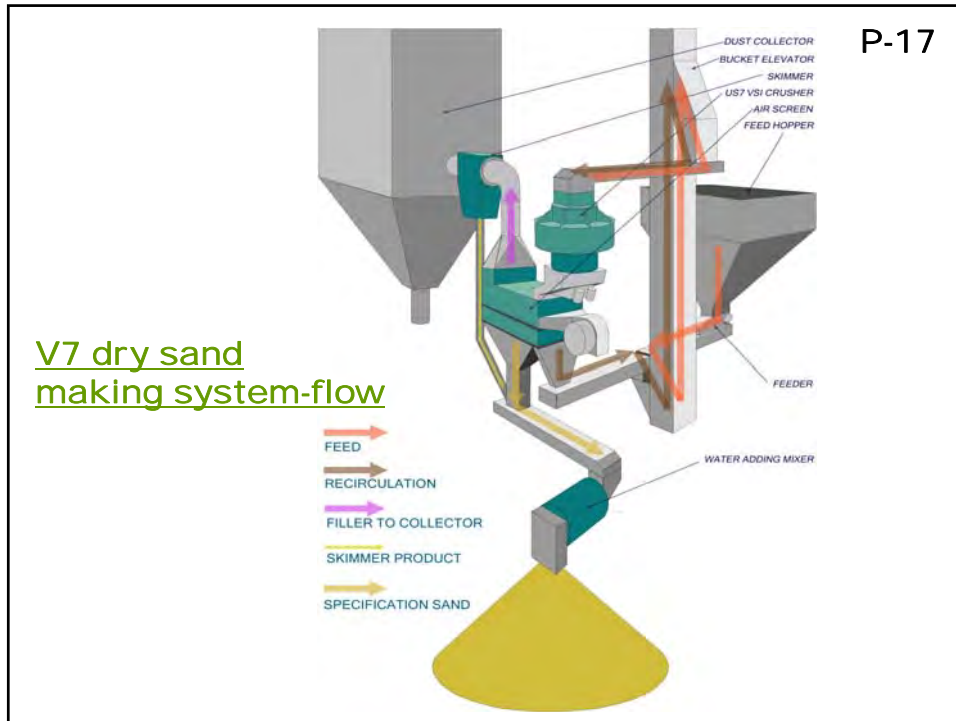

3 sets of V7-100 on a common platform for the biggest cement manufacturer in Japan P-19



V7 sand trial mix data

P-20

Case 1=> V7 sand:30%/Natural sand:70%

Specified mix				Property of concrete					
Sample No.	Specified strength	W/C (%)	Slump (cm)	Slump (cm)	Entrapped air (%)	Flow value (cm)	Workability	Compressive strength (N/mm ²)	
								7 days	28 days
1	18	68	8	10.0	4.8	-	Good	16.8	26.2
2		68	15	16.5	5.2	26.5 X 26.0	Good	18.1	27.0
3	24	57	8	9.5	4.6	-	Good	26.3	35.0
4		57	18	19.5	5.1	33.5 X 34.0	Good	25.8	34.3
5	30	49	15	16.5	4.6	25.5 X 27.0	Good	30.6	41.2
6		49	18	20.0	4.8	34.0 X 25.0	Good	31.1	40.6

Case 2=> V7 sand:70% / Natural sand:30%

Specified mix				Property of concrete					
Sample No.	Specified strength	W/C (%)	Slump (cm)	Slump (cm)	Entrapped air (%)	Flow value (cm)	Workability	Compressive strength (N/mm ²)	
								7 days	28 days
1	18	68	8	9.5	4.4	-	Good	17.1	27.2
2		68	15	16.0	5.5	26.5 X 26.5	Good	17.8	28.1
3	24	57	8	10.0	4.2	-	Good	27.3	34.3
4		57	18	19.5	4.9	32.0 X 34.0	Good	26.5	34.9
5	30	49	15	16.5	4.6	27.0 X 27.0	Good	31.0	40.3
6		49	18	19.5	4.8	34.0 X 33.0	Good	32.1	41.2

Specified mix remains unchanged!

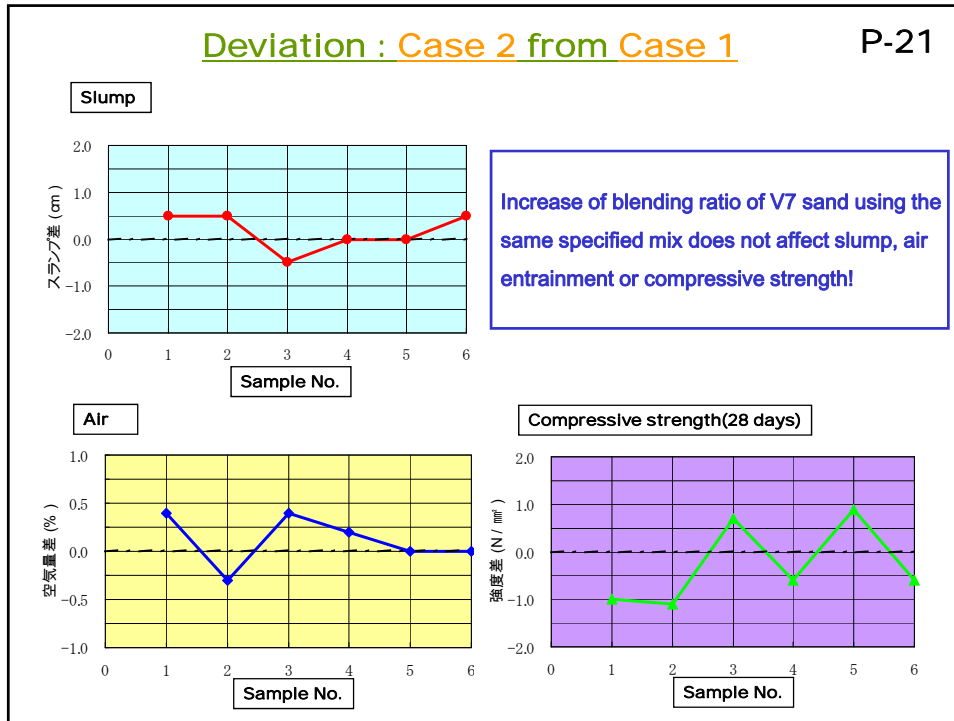

Actual cases in Japan. P-22

Case 1: A ready-mixed concrete plant "H"
 From 100% of sea sand to 50% of V7 sand:
 => Reduction of unit water content by 7 – 9 kg

Case 2: A ready-mixed concrete plant "S"
 From 100% of sea sand to 100% of V7 sand:
 => Improvement of the workability of concrete.

Case 3: A ready-mixed concrete plant "T"
 => Achieved saving of 11kgs of unit water content and 15-20kgs of unit cement content.

Kemco presentation

P-23

HOW CRUSHED SAND WAS DEVELOPED IN JAPAN AND WHAT ARE WE DOING NOW - 5 MAIN POINTS:

1. **History of the use of fine aggregate and the current situation in Japan.**
2. **The current situation of crushed sand making machines in Japan.**
3. **Technical and commercial explanation of V7 dry sand making system .**
4. **The filler problem .**
5. **What is commercially most preferable sand?**

Filler

P-24



Filler processing machine P-25

Filler



Granular



-> Crush -> Knead ->

80 of Filler + 15% of water and 5% of cement

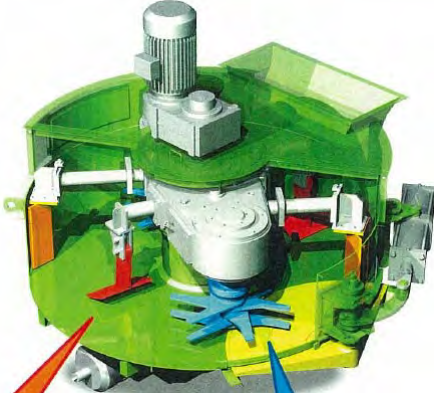
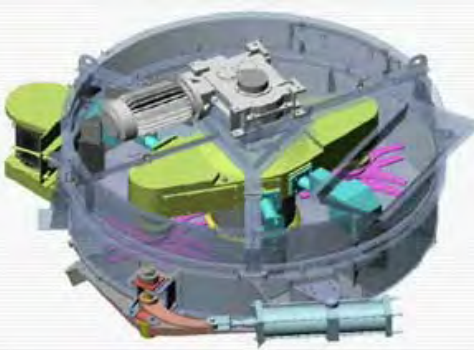

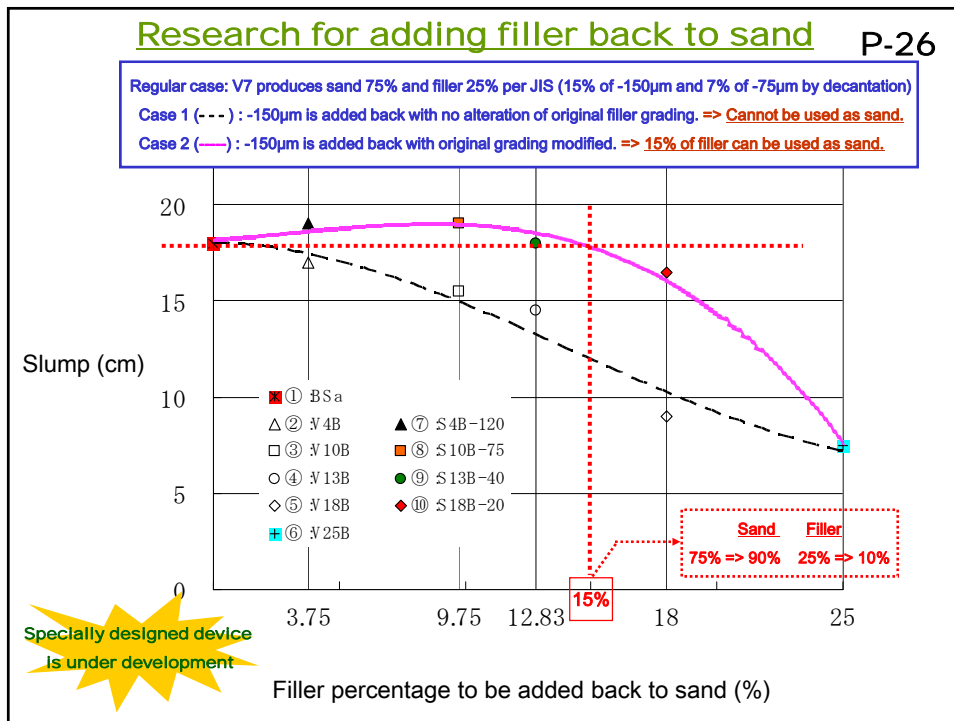
Kemco presentation

P-27

HOW CRUSHED SAND WAS DEVELOPED IN JAPAN AND WHAT ARE WE DOING NOW - 5 MAIN POINTS:

1. **History of the use of fine aggregate and the current situation in Japan.**
2. **The current situation of crushed sand making machines in Japan.**
3. **Technical and commercial explanation of V7 dry sand making system .**
4. **The filler problem .**
5. **What is commercially most preferable sand?**

Natural sand and manufactured sand & what Kemco can do.

P-28

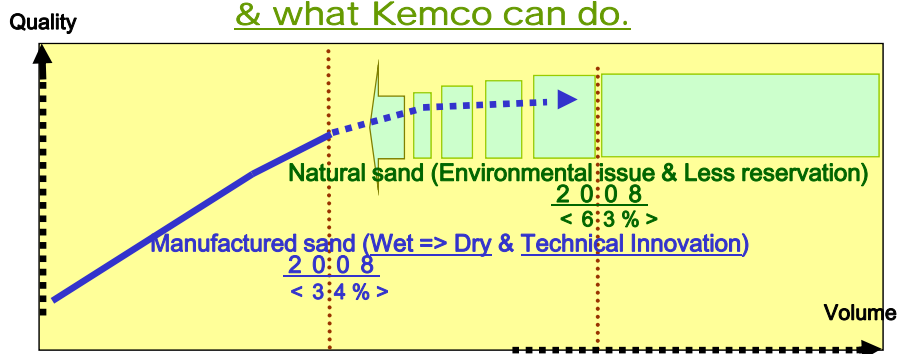

① Market is selective:

=> Supplying the products with high performance. For last 10 years, wet system with less cost performance disappeared and V7 got 90% of market share in Japan..

② Innovation:

=> V7 sand is also used for dam and nuclear power plant construction where it was thought dry manufactured sand could not be used.

③ Close but often ineffective relationship:

=> The relationship between concrete and aggregate producers is both close and distant :
Several hundreds of test data for sand sample and concrete trial mix in "KEMCO Archive".
Kemco wants to be a bridge between the two branches of the industry.

Kemco's RC 7 demolition concrete recycling plant

P-30



Removing cement paste which remains on the surface of demolition concrete

P-31

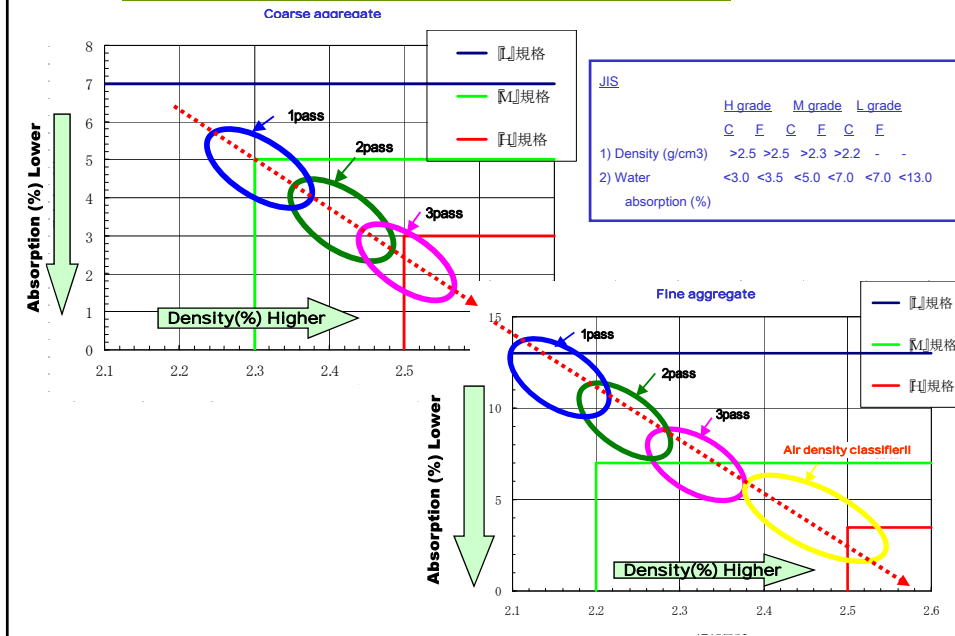

Kemco's challenge to new field

P-29

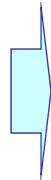

Thank you!

Kotobuki Engineering &
Manufacturing Co.,Ltd.
Japan



CHALMERS Chalmers University of Technology

Development of Crushing Technology for Manufactured Sand



Chalmers Rock Processing Research
www.crpr.se

08-11-03 Magnus Evertsson, CRPR, PPU Sida 1

CHALMERS Chalmers University of Technology

- Crushing technology for manufactured sand
- Real-time optimisation
and statistical process control

08-11-03 Magnus Evertsson, CRPR, PPU Sida 2

CHALMERS Chalmers University of Technology

Crushing technology for manufactured sand

Understand how particle shape can be affected in 36-500 μ m.

08-11-03 Magnus Evertsson, CRPR, PPU Sida 3

CHALMERS Chalmers University of Technology

Crushing technology for manufactured sand

- How should different rock types can be treated to achieve required particle shape?
- How should crushers be designed and controlled?
- Are existing crushers optimised for production of 0-2mm?

08-11-03 Magnus Evertsson, CRPR, PPU Sida 4

CHALMERS Chalmers University of Technology

Energy efficiency

Decreasing energy efficiency

- Single particle compression
- HPGR
- Crushing
- Milling

08-11-03
Magnus Evertsson, CRPR, PPU
Sida 5

CHALMERS Chalmers University of Technology

10⁻³ 10⁻² 10⁻¹ 10⁰ 10¹ 10² 10³ mm

Possible crushing limit (2-3 mm) →

Typical topsize for ball mill feed, (-6mm, -12 mm) →

Gyratory or Jaw
2nd. Cone or Gyratory
3rd. Cone
VSI
HPGR
AG-SAG

Manufactured sand for concrete (0.040-4 mm)

08-11-03
Magnus Evertsson, CRPR, PPU
Sida 6

CHALMERS Chalmers University of Technology

Manufactured sand for concrete

- New criterias.
- What are the needs?

08-11-03 Magnus Evertsson, CRPR, PPU Sida 7

CHALMERS Chalmers University of Technology

Interface
What is our common language?
Definitions?

08-11-03 Magnus Evertsson, CRPR, PPU Sida 8

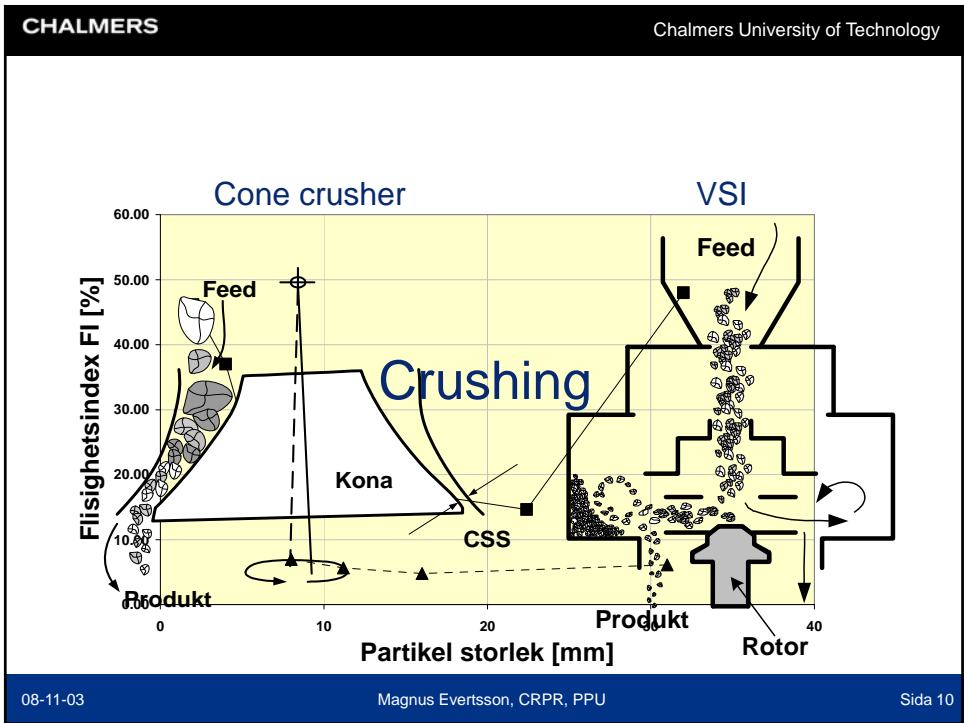
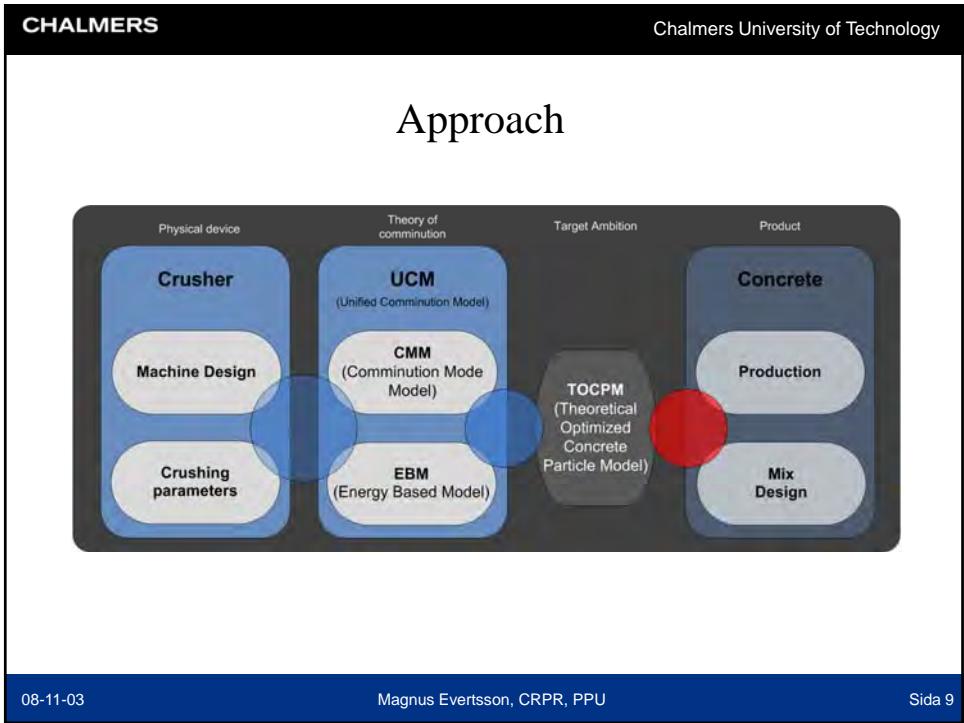

CHALMERS Chalmers University of Technology

Compressive versus impact crushing

- Completely different crushing technique
- So far, impact crushing have produced better shape compared to compressive crushing.

08-11-03 Magnus Evertsson, CRPR, PPU Sida 11

CHALMERS Chalmers University of Technology

F-Shape

Light microscope
+250-500 microns

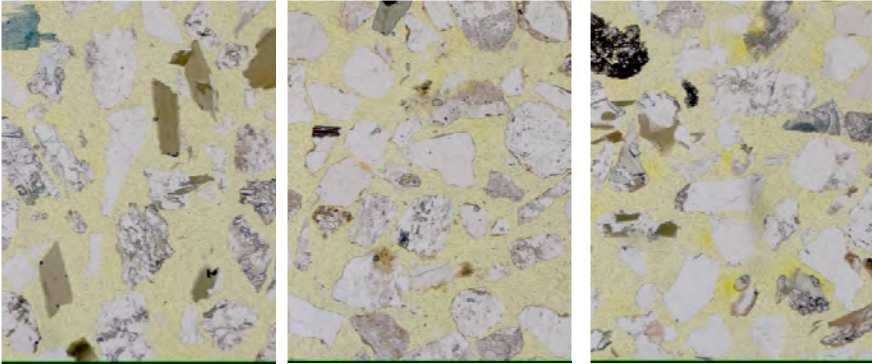

Cone crusher **Natural gravel** **VSI**



08-11-03 Magnus Evertsson, CRPR, PPU Sida 12

CHALMERS Chalmers University of Technology

F-Shape

Light microscope

+250-500 microns

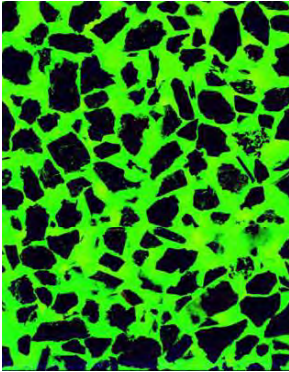



Cone crusher

Natural gravel

VSI

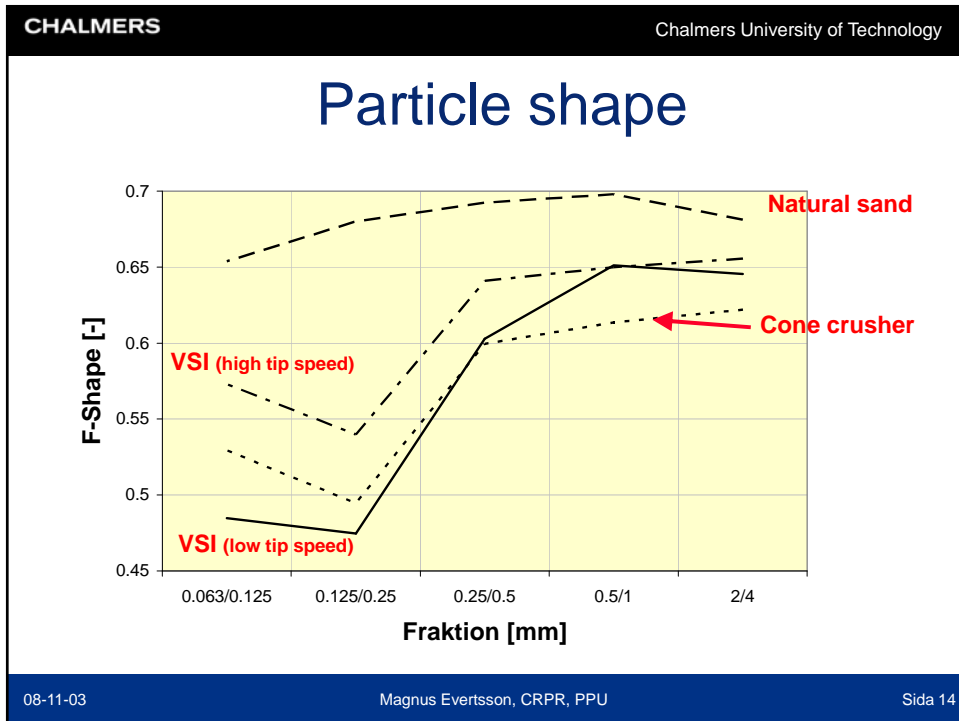
08-11-03
Magnus Evertsson, CRPR, PPU
Sida 13



CHALMERS Chalmers University of Technology

Particle shape

Reology test



- New Zealand standard **3111:1986**
- Mass flow

08-11-03 Magnus Evertsson, CRPR, PPU Sida 15

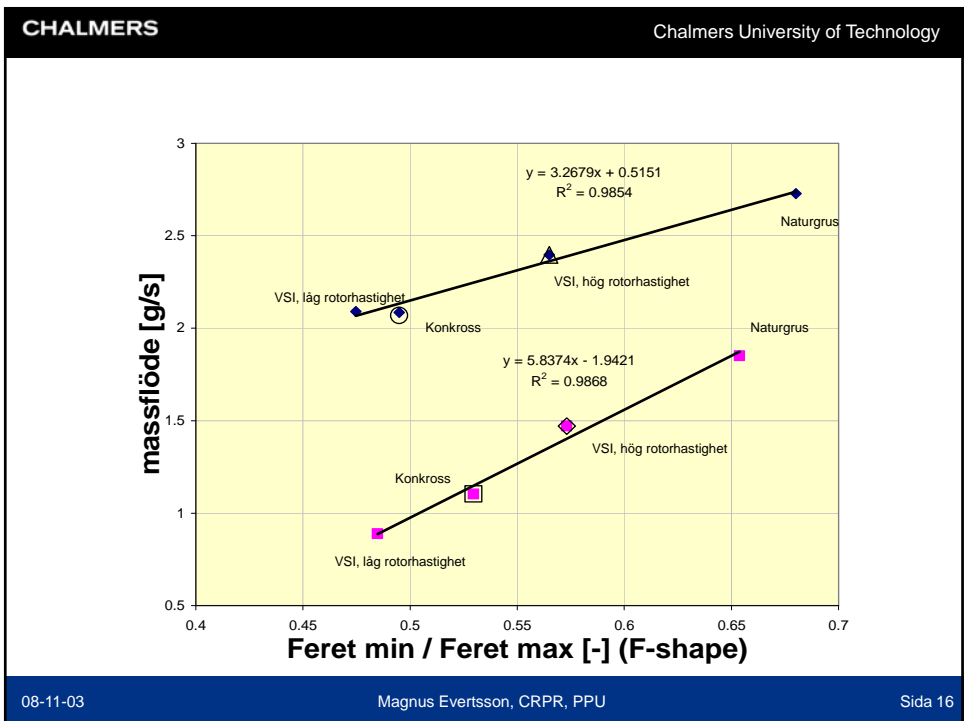

- Particle shape affects dry reology!
- Wet reology/viscosity?
- Flow cone tests correlates very well with F-shape.(and % voids)
- Fast practical test.

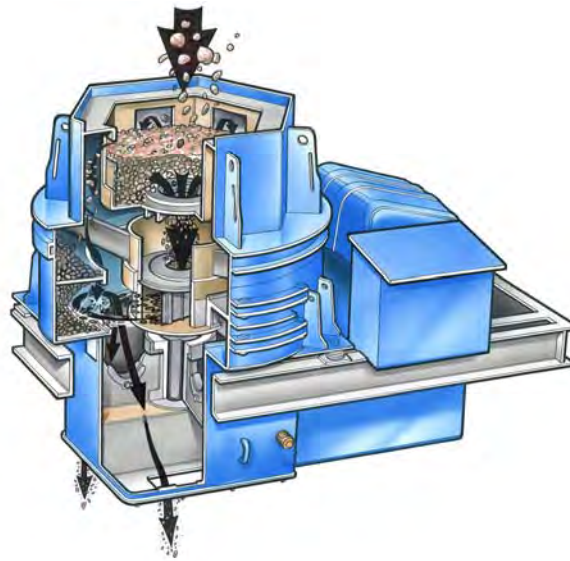

CHALMERS Chalmers University of Technology

Vertical Shaft Impact Crusher



08-11-03 Magnus Evertsson, CRPR, PPU Sida 19

CHALMERS Chalmers University of Technology

- What is the optimal way of crushing a particle? (for use in concrete)
- Different particle sizes leads to
 - different energy levels
 - different speed levels?
 - different technical design?

08-11-03 Magnus Evertsson, CRPR, PPU Sida 20

CHALMERS Chalmers University of Technology

UCM

Unified Comminution Model

Comminution Mode Model

Energy Based Model

Crushing modes

- Impact cleavage
- Abrasive chipping
- Abrasion

W. Schubert et al. / Int. J. Miner. Process. 75 (2005) 41–50

Compression -55 -43 -30 -17 -5 0 13 Tension

Stress velocity in m/s

08-11-03 Magnus Evertsson, CRPR, PPU Sida 21

CHALMERS Chalmers University of Technology

TOCPM

- Theoretical Optimized Concrete Particle Model

- Interface between aggregates production and concrete
- Common language?
- Definitions?
- Need for communication and knowledge exchange.

08-11-03 Magnus Evertsson, CRPR, PPU Sida 22



Real-time optimisation

- Rock properties vary with time
- Wear affects performance and output
- Fixed values of any parameter can **not** be optimal
- Desirable to compensate for these effects

Real-time optimisation

- More and better sensor techniques needed
- Additional control parameters must be identified

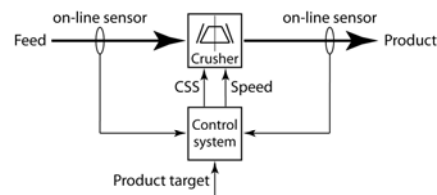

- Control theories and algorithms

CHALMERS Chalmers University of Technology

Real-time optimization

- The foundation of process control is data sampling
- Mass flow sensors provide product capacities in real-time
- Speed is identified as a new process parameter for real-time control

08-11-03 Magnus Evertsson, CRPR, PPU Sida 27

CHALMERS Chalmers University of Technology

Parameter effect on crusher output

08-11-03 Magnus Evertsson, CRPR, PPU Sida 28

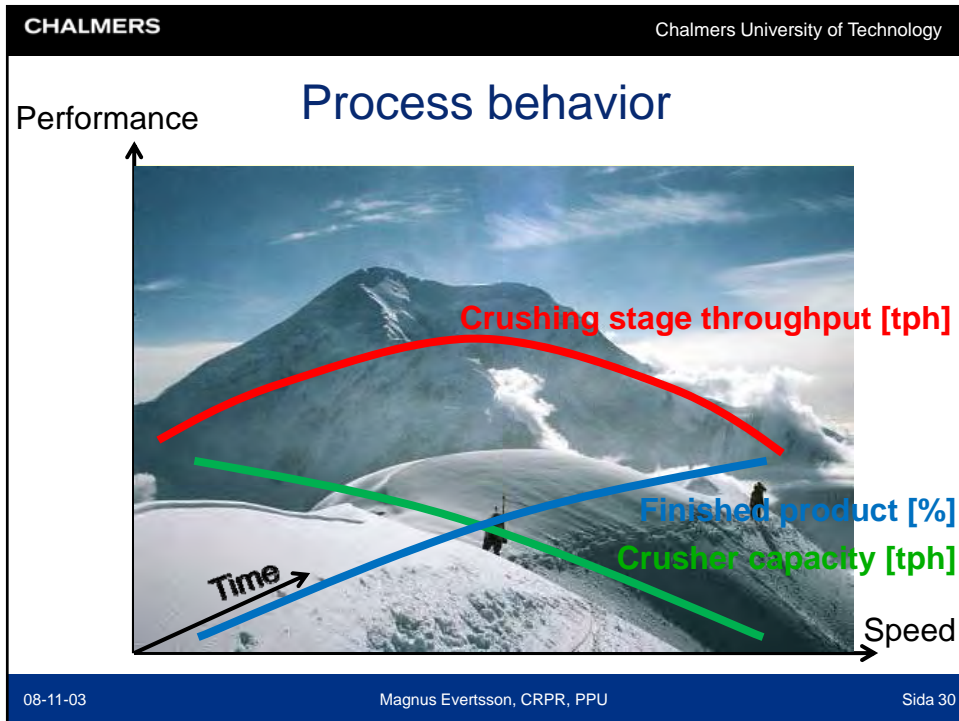
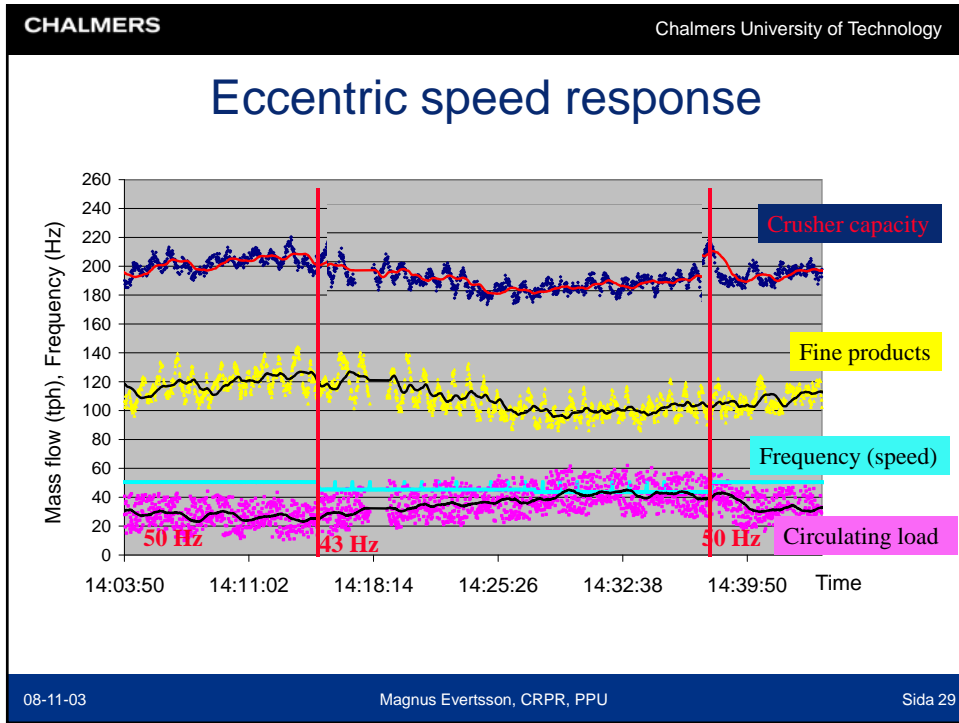

CHALMERS Chalmers University of Technology

Implementation

HP 300 cone crusher

**Emerson
frequency converter**

Heidelberg Cement Group's aggregates plant "Ludden", Sweden

08-11-03
Magnus Evertsson, CRPR, PPU
Sida 31

CHALMERS Chalmers University of Technology

Implementation

- HMI/SCADA
- Three speed modes:
 - Standard speed (fixed)
 - Manual choice (fixed)
 - Algorithm (dynamic)
- Several complete mantle set lifetime studied

08-11-03
Magnus Evertsson, CRPR, PPU
Sida 32

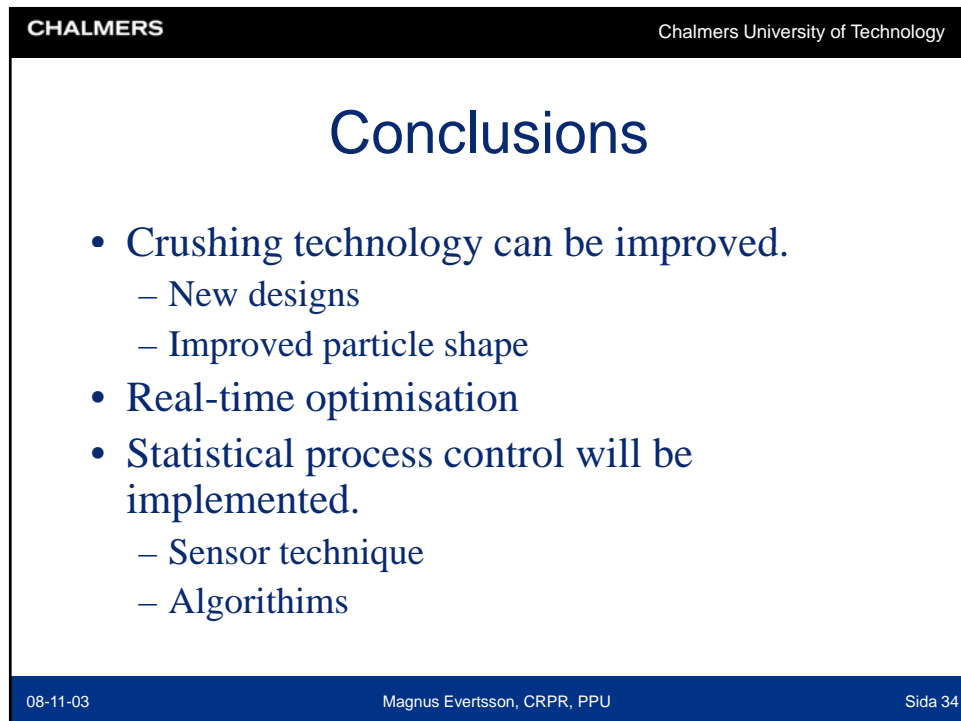
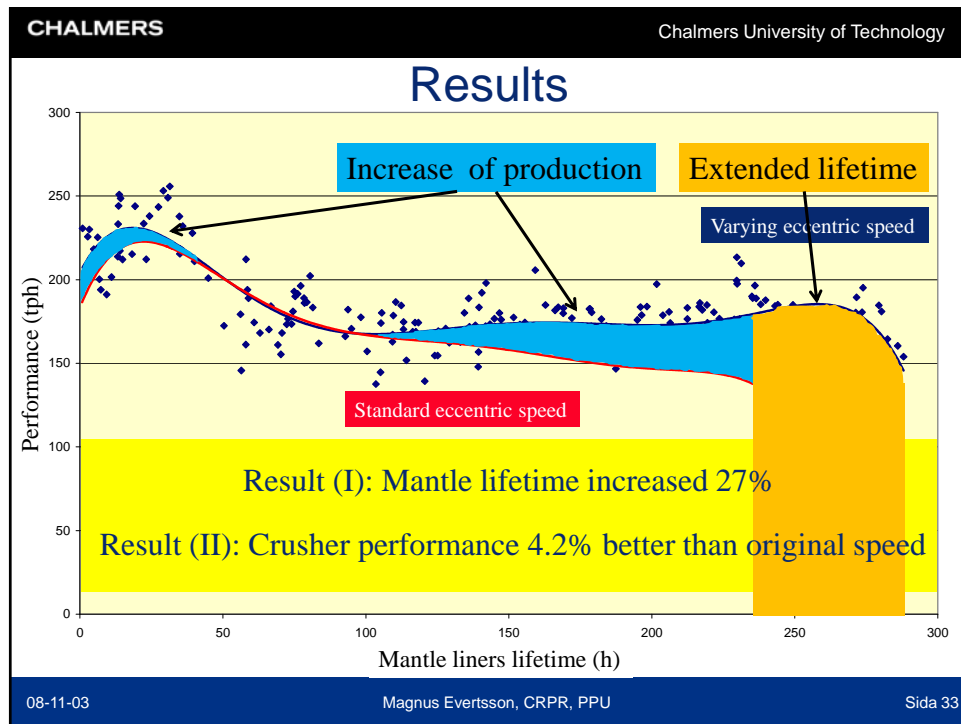

A preliminary study on manufactured sand in concrete

- Effect of grading and fines content

COIN workshop on manufactured sand in Stavanger, October 2008

Bård Pedersen
NorStone AS

NORSTONE
HEIDELBERGCEMENT Group

Case: NorStone Tau hard rock quarry



Slide 2 - 31.10.2008

NORSTONE
HEIDELBERGCEMENT Group

Physical properties



- Quartz diorite/ mylonite
- Good mechanical properties:
 - Los Angeles: 10
 - Micro deval: 8
- Density: 2,75
- Water absorption: 0,1 %
- Moderately alkali-reactive (ASTM C1260: 0,16 %)

Slide 3 - 31.10.2008

NORSTONE
HEIDELBERGCEMENT Group

Production facilities

- 3-step gyratory crushing
- VSI Kemco Rotopactor
- Yearly production: 2,2 million tons
- Shape of particles (Flakiness index):

	2/5mm	5/8mm	8/11mm	11/16mm	16/22mm
Before VSI	33	26	21	14	13
After VSI	20	15	11	8	8

Slide 4 - 31.10.2008

NORSTONE
HEIDELBERGCEMENT Group

Case description

- The material from Tau is known as a high-quality material for asphalt and general road building applications
- So far only limited use as concrete aggregate
- Known from earlier studies: The coarse fractions (+ 8 mm) does not give any reductions in workability compared to natural coarse aggregate
- What is the potential for utilization of the sand (0/8) in concrete?

Slide 5 - 31.10.2008

NORSTONE
HEIDELBERGCEMENT Group

Concrete testing

Concrete mix design:

- C 30/37
- w/c: 0,57
- Cement: Norcem Standard FA (CEM II/ A-V 42,5 R)
- Plasticizers:
 - Lignosulphonate (0,5 % of cement weight)
 - Sikament FB-2 Polycarboxylate (0,3 % of cement weight)
- Reference aggregate: NorStone Årdal - naturally rounded glaciofluvial aggregate

Slide 6 - 31.10.2008

NORSTONE
HEIDELBERGCEMENT Group

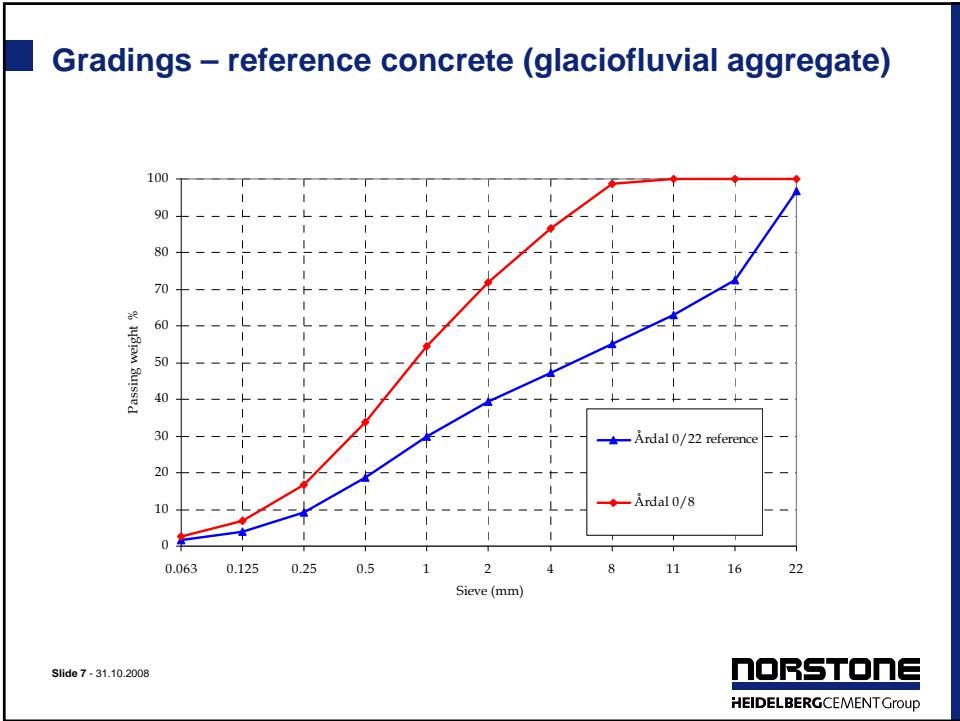

Slide 7 - 31.10.2008

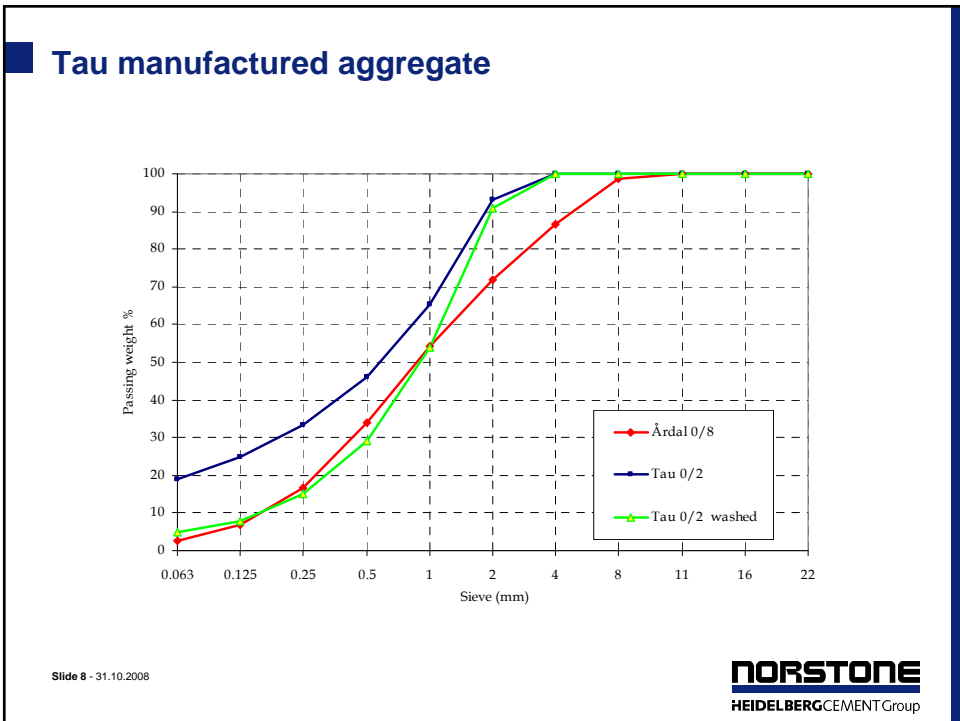

Slide 8 - 31.10.2008

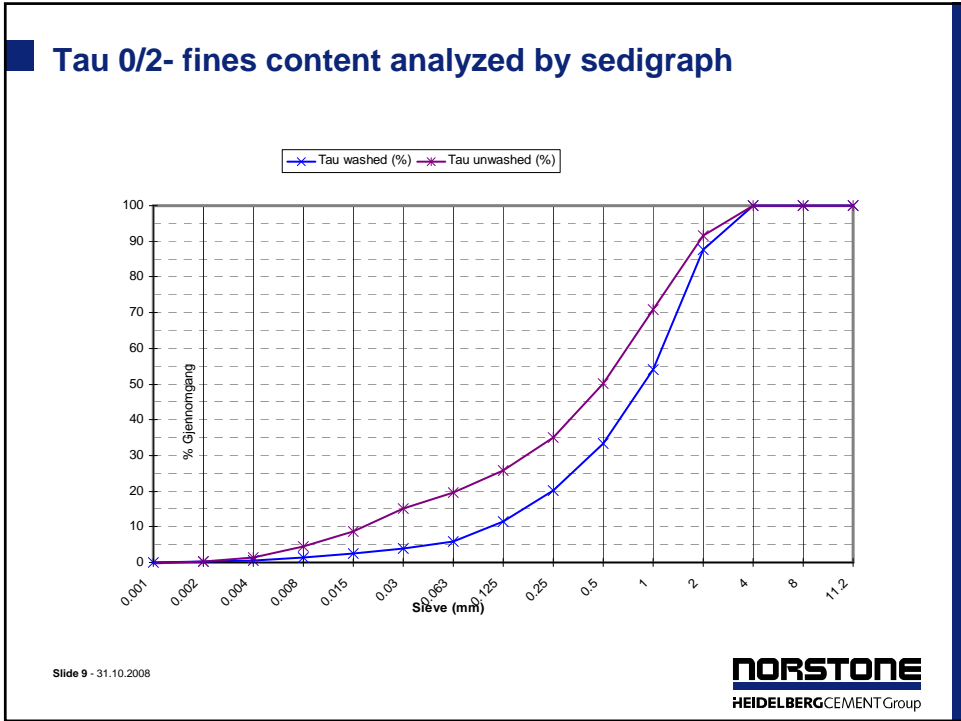

Slide 9 - 31.10.2008

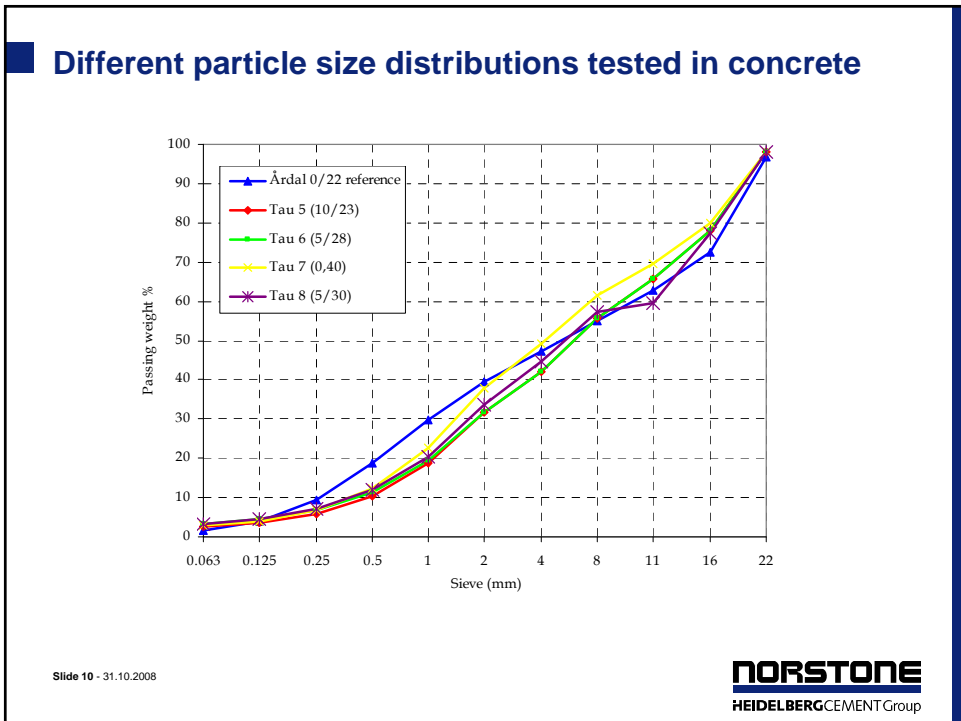

Slide 10 - 31.10.2008

Concrete results (slump)

	Slump (mm)	
	Initially	After 30 minutes
Ref (Årdal)*	205	160
Tau 5 (10/23) **	180	90
Tau 6 (5/28)	195	140
Tau 7 (0/40)	190	155
Tau 8 (5/30, gap grading)	210	-

* Reference mix with cement content of 295 kg/m³, all other mixes with 335 kg/m³.
(corresponds to 168 liters of water versus 191 liters/m³).

** Numbers in brackets: percentage of unwashed/ washed 0/2

Slide 11 - 31.10.2008



Concrete results:

Workability:

Tau manufactured sand requires 12-15 % increase in cement- and water content compared to natural sand.

Compressive strength:

Preliminary results indicate a strength increase of 10-12 % when substituting natural sand with manufactured sand (for strength class C30/37)

Slide 12 - 31.10.2008



■ Conclusions and need for further work

- The potential to develop a manufactured sand suitable for concrete is obvious
- One challenge is to establish a classification process, either wet or dry which gives suitable and stable products
- The ASR has to be dealt with separately

Slide 13 - 31.10.2008

NORSTONE
HEIDELBERGCEMENT Group



Grace Performance Chemicals

Comparison of rheological and mechanical properties of mortars prepared with manufactured and natural fine aggregates

Manufactured sand – workshop
Stavanger, October 31st

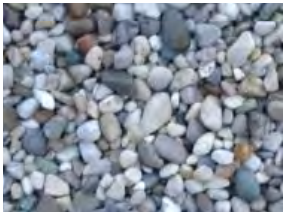

Aggregate Classification

<p><u>Sand and Gravel</u> Fine: natural sand Coarse: gravel</p>  <ul style="list-style-type: none"> ▪ Unconsolidated sedimentary materials transported by water, ice, or wind ▪ Dug or dredged from deposits (glacial, river, lake, marine), then screened and washed (sized) ▪ May be crushed to reduce size ▪ Generally smooth texture, rounded shape (increased workability, reduced strength) 	<p><u>Crushed Stone</u> Fine: manufactured sand Coarse: crushed stone</p>  <ul style="list-style-type: none"> ▪ Blasted from hard rock deposits, then crushed, screened, and washed ▪ Crushing creates large quantities of fines up to 20 – 30% of <75 µm (smaller size = lower value) ▪ Generally rough texture, angular shape (reduced workability, increased strength)
---	--

GRACE

2 Manufactured Sand Workshop - Stavanger, October '08

Aggregate Characteristics Affecting Concrete Rheology

Shape

Sharp corners increase friction between particles



Gradation

Small particles are not available to fill voids between larger particles

Well graded | Poorly graded

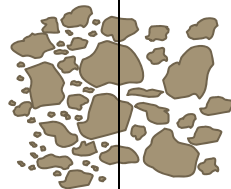

Cleanliness

Smectite clays consume polycarboxylate-based admixtures

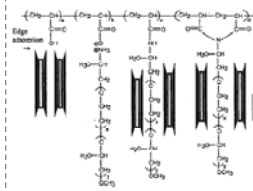

3

Manufactured Sand Workshop - Stavanger, October '08

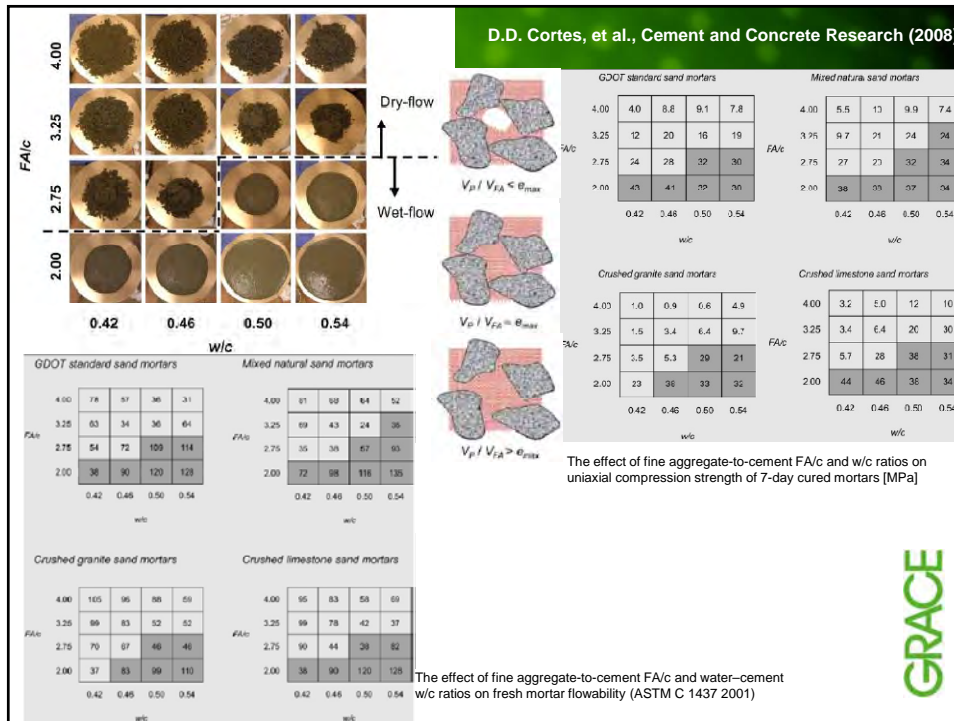

Jeknavorian et al.

```

    graph TD
      A[Decreased workability] --> B[Danger of segregation]
      C[Increased friction] --> D[higher pumping pressures  
increased efforts with placement and  
finishing operations.]
      E[Angular particle shape  
Rough surface texture] --> F[Increased void space  
Increased surface area]
      F --> G[Increased water content  
to maintain consistent  
workability  
Paste volume increase  
(more cement or SCM)]
    
```

Chemical admixtures, especially polycarboxylate-based HRWRs, have been found to be useful to minimize the need for both increased water and paste contents that could be required with manufactured sands.

GRACE

5 Manufactured Sand Workshop - Stavanger, October '08

Jeknavorian et al.

Starting with the control mixture described in Table 2 and prepared with each of the natural and manufactured sands identified in Table 1, the paste content was increased from 10 to 40% by mass. In addition, the control mixture with the manufactured sand was dosed with 0.003% VMA actives by weight of cement (% s/s).

Manufactured Sands (HS)	Natural Sand (NS)	Location
GC-HS	EN	Standard Sand - Europe
HSLO-HS	HC-NS	Central California
MARJ-HS	HSLO-NS	Central California
CP-HS	NS	Arizona
BARGE-HS	CP-NS	Arizona
S-HS	HV-NS	Southern California
D-HS	DUR-HS	Southern California
FL-HS	-	Illinois
FL-HS	FL-NS	Florida

Table 1

	Control	Control w/ VMA	Control + 10% Paste	Control + 20% Paste	Control + 30% Paste	Control + 40% paste
Cement	400	400	440	480	520	560
Sand	800	800	800	800	800	800
Water	188	118	207	225	244	263
VMA, % s/s	-	0.0035	-	-	-	-

Table 2

GRACE

6 Manufactured Sand Workshop - Stavanger, October '08

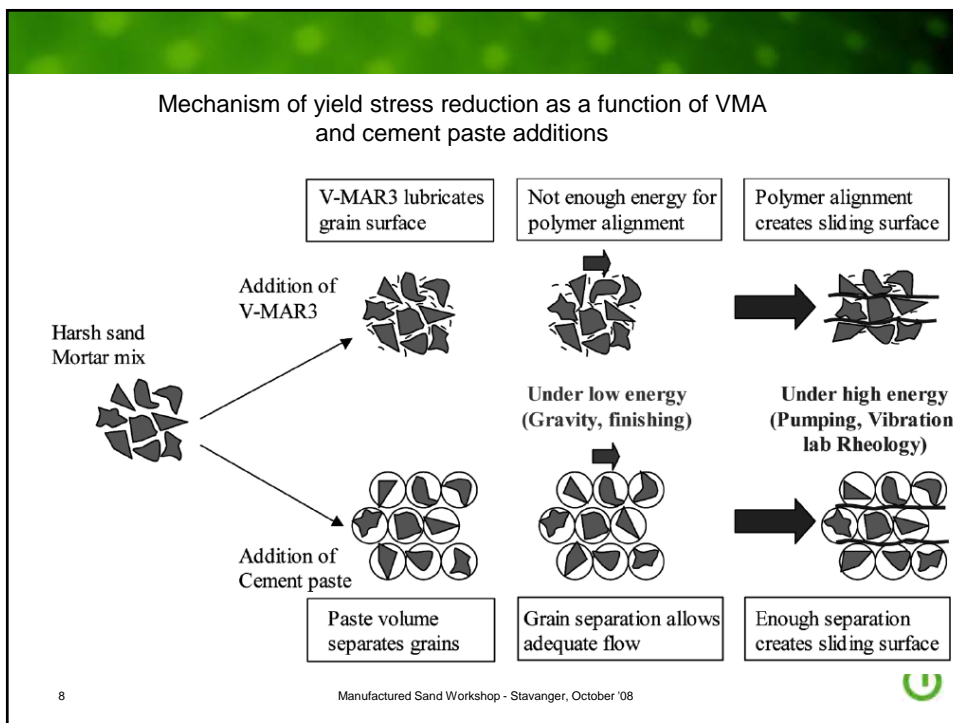
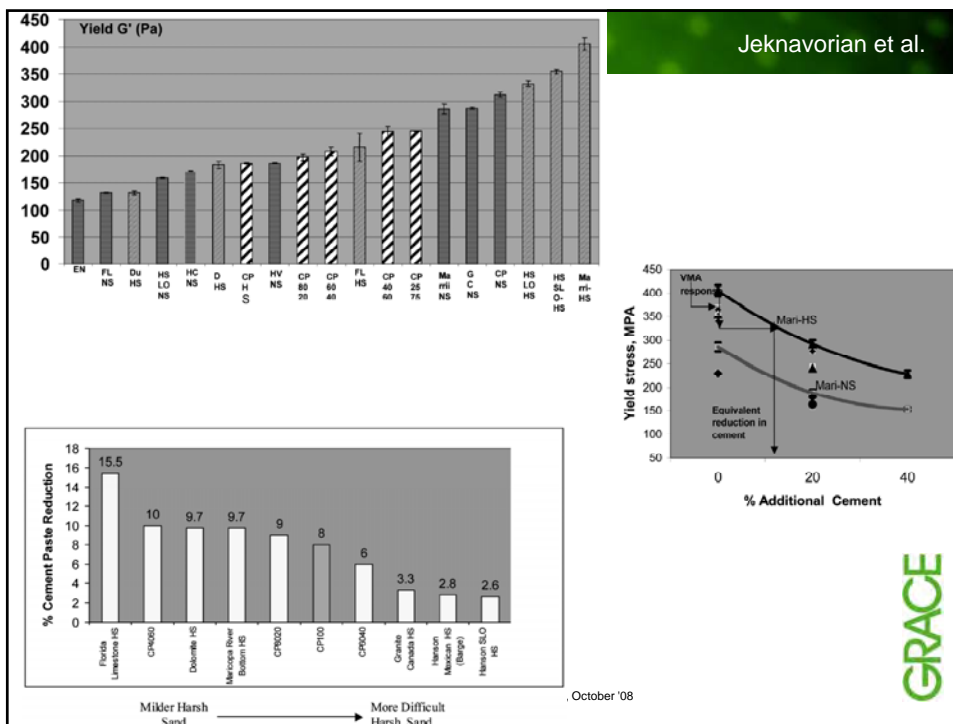

What is Clay?

Size Definition (e.g. AASHTO, USDA, USCS)*

- Gravel: >2 mm
- Sand: 75 µm to 2 mm
- Silt: <75 µm
- Clay: <2 µm ← Often flocculated (appear as larger sizes)

*Each organization uses slightly different sizes to distinguish categories.

Mineralogy (Composition) Definition
Hydrous aluminum-phylosilicates with certain layered structures (tetrahedral and octahedral sheets and exchangeable cations) and exhibiting plasticity in presence of water

- Kaolinite
- Montmorillonite/Smectite
- Illite
- Chlorite

For concrete, we care about mineralogy.

Clay (particularly smectite) can be very detrimental to concrete and asphalt. Non-clay fines may be beneficial for concrete. Because aggregate processing is based on size separation, most microfines are often removed even if they do not contain clay.



9
Manufactured Sand Workshop - Stavanger, October '08

Clay in Aggregates

The <75 µm fraction of an aggregate is composed of a variety of minerals, including both CLAY and NON-CLAY minerals.

Although particles are of similar SIZE, different mineralogy results in different CONCRETE PERFORMANCE.

Clay Minerals	Non-Clay Minerals
Consume and retain significant quantities of water and HRWR = reduced workability, reduced strength, increased shrinkage Examples*: smectite/montmorillonite, kaolinite, illite, chlorite <small>*smectite most severe, chlorite not always classified as clay.</small>	Do not absorb appreciable quantities of water or HRWR, may enhance overall gradation = improved workability* Examples: quartz, feldspar, calcite, dolomite, mica <small>*depends on mixture proportions.</small>

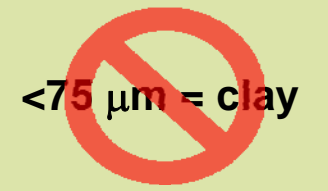

Do not assume that all material finer than a certain size is clay. Size and shape alone do not fully determine performance.



10

Limits on Clay in Concrete Aggregate (United States)

Traditionally, 1-3% clay was associated with pop-outs, shrinkage, poor paste-aggregate bond, and increased water demand.

With polycarboxylate-based HRWRs, 0.1% clay can make the use of such admixtures cost prohibitive.

ASTM C 33 Standard Specification for Concrete Aggregates
Material finer than 75 µm

- <3-5% for sand and gravel
- <5-7% for manufactured sand
- Clay lumps and friable particles 3% max

Sand Equivalent (ASTM D 2419) or Durability Index Test (ASTM D 3744 or California 227 and 229)

- Typically requires lower clay than ASTM C33 limits
- Does not distinguish effectively between clay and non-clay fines

Methylene Blue Value (not commonly specified)

- Simple and effective test for predicting effect of clays on HRWR demand

Specifications should distinguish between clay and non-clay fines and clay types. Therefore, the Methylene Blue Test is preferred.

11

Manufactured Sand Workshop - Stavanger, October '08

Clay mitigating solution

For poor cleanliness, GRACE has patented technology to reduce the effects of swellable clay.

One example in the US is clay mitigating PC-HRWR 'ADVA 140M'. We have the ability to formulate for different clay levels.

The presence of swellable clay reduces the effectiveness of PC to a greater extent than NSFC (expressed by the PC/NSFC ratio).

The following data are mortar results for concrete sands from the Southwest US. The presence of smectite clay, indicated by increased MBV, increases the PC/NSFC ratio.

The clay mitigating PC-HRWR reduces this increase in PC/NSFC ratio.

Methylene Blue Value (mg/g)	Polycarboxylate/Naphthalene Dose Ratio
0	0.15
5	0.25
10	0.35
15	0.45
20	0.55
25	0.65
30	0.75

Sand	Standard PC-HRWR	Clay Mitigating PC-HRWR
Sand A (MBV = 8.5 mg/g)	~165%	~135%
Sand B (MBV = 7.5 mg/g)	~145%	~95%



**CASTING OF CONCRETE MADE
BY CRUSHED AGREGATE**

CONTIGA AB

Contiga AB
Rescon Mapei AS
SINTEF

Dan Arve Juvik, Rescon Mapei AS



 International R&D- centre
Rescon Mapei AS - Sagstua, Nord-Odal

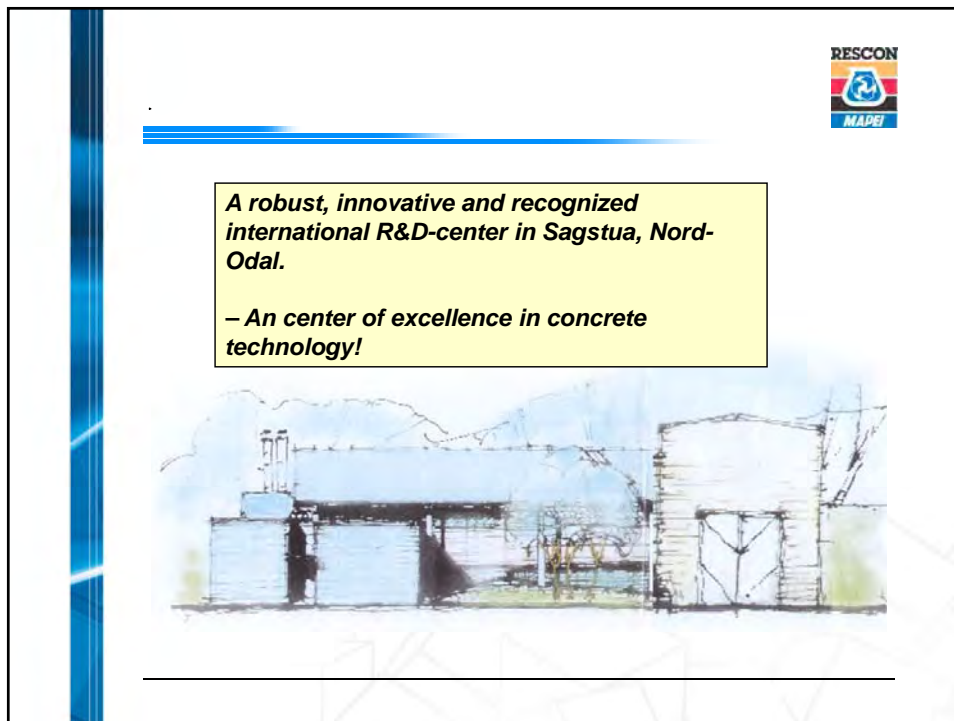
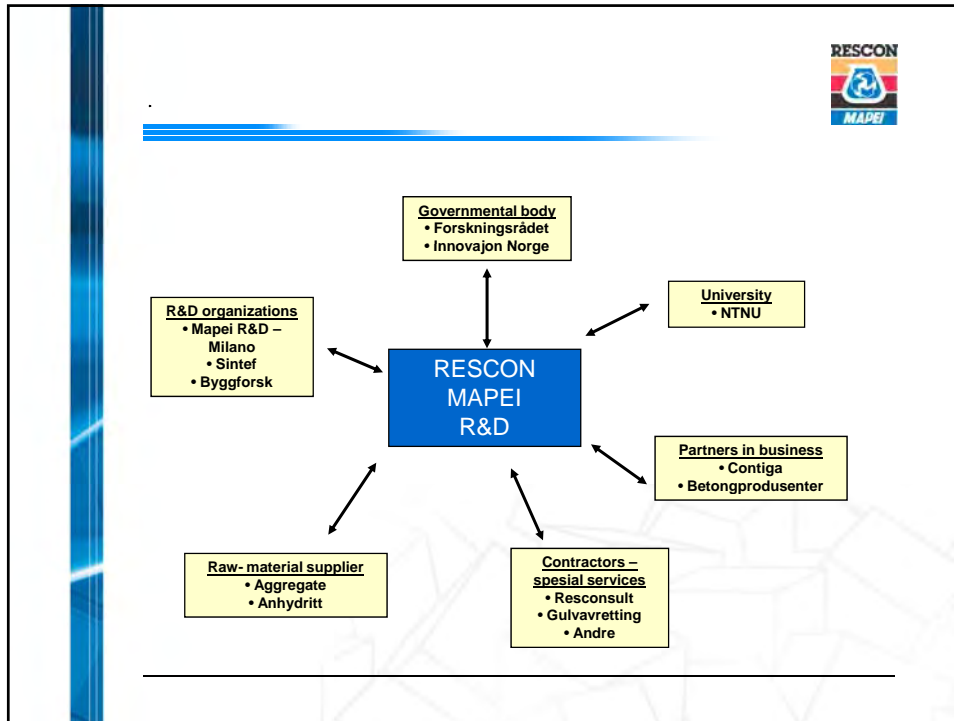

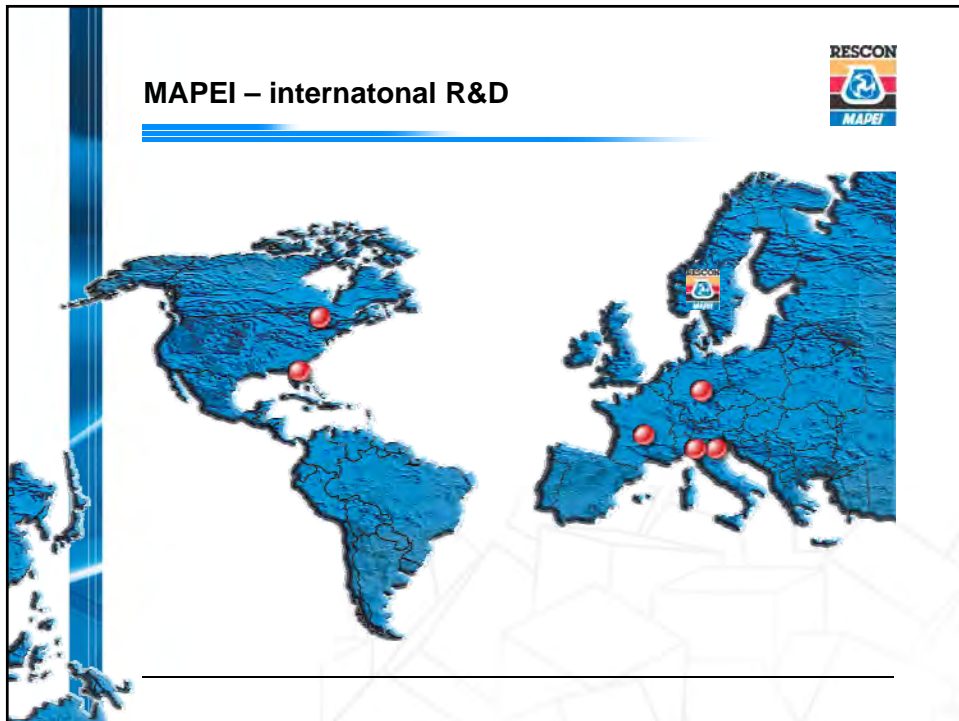

The project



- Testing in laboratory, and full scale casting of wall element.
- Contiga AB, Norrtälje
- Contiga, Rescon Mapei AS, SINTEF

Sieve analysis

Vårt merke	Sikterest i %, på sikt med maskevidde, mm										
	0,063	0,125	0,25	0,5	1	2	4	8	16	20	25
Danderyd 0/8		94,5	85,0	64,0	36,0	13,0	4,0	0,0			
Rimbo 0/2		93,1	81,6	63,7	37,9	4,9	0,3	0,1	0,0		
Danderyd 8/16		100,0	100,0	100,0	100,0	100,0	99,5	92,0	5,0	0,0	
Rimbo 2/4		100,0	100,0	100,0	100,0	90,0	50,0	10,0	0,0		

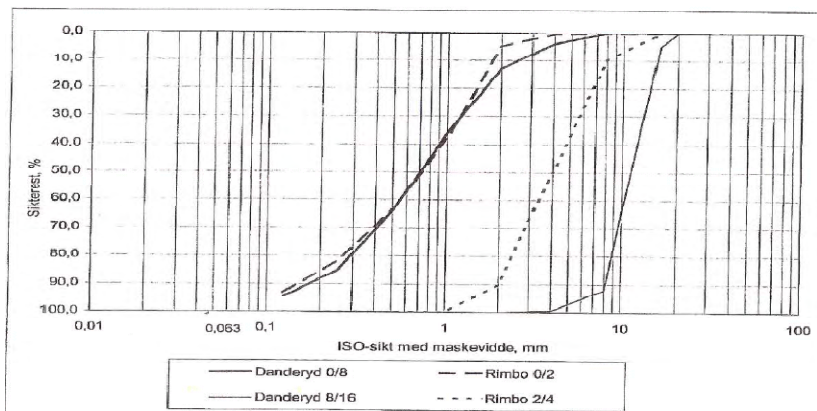

Testing in laboratory, SINTEF							
Tabell 1A: Materialsammensetning og prøvingsresultater							
Blanding	1	2	3	4	5	6	7
Serie	Natur	MASA			MASA + 2/4		
Matriksinnhold, l/m ³	318	327	337	348	323	308	337
Sementlim, l/m ³	299	305	315	326	302	287	317
Betong-sammen-setning, kg/m ³	Sement	412	423	436	453	419	442
	1) Danderyd 0/8	990	-	-	-	-	-
	Rimbo 0/2	-	934	919	910	879	899
	Rimbo 2/4	-	-	-	-	196	201
	Danderyd 8/16	987	1017	999	990	882	903
2) Dynamon SP-N	6,2	6,4	6,5	6,8	6,3	6,0	6,6
3) Fritt vann	166	169	175	181	168	159	175
v/c-forhold	0,40	0,40	0,40	0,40	0,40	0,40	0,40
Synkmål, mm	125	180	185	200	160	75	210
Lufthold, %	2,1	1,7	1,3	1,2	1,4	2,1	1,0
Densitet, kg/m ³	2555	2545	2530	2535	2545	2560	2540
Trykkfasthet, MPa etter	1 døgn	-	-	-	60,9	63,1	64,3
	2 døgn	68,0	69,3	70,4	-	-	-
	7 døgn	76,9	79,2	77,7	76,2	78,6	79,0
	28 døgn	85,9	87,2	86,3	86,2	86,8	88,3

Merknad: ¹⁾ Inkl. absorbert vann
²⁾ Tilsvarende 1,5 % av sementvekt
³⁾ Totalt vann eks. vann absorbert i tilslaget, men inkl. vann i Dynamon SP-N

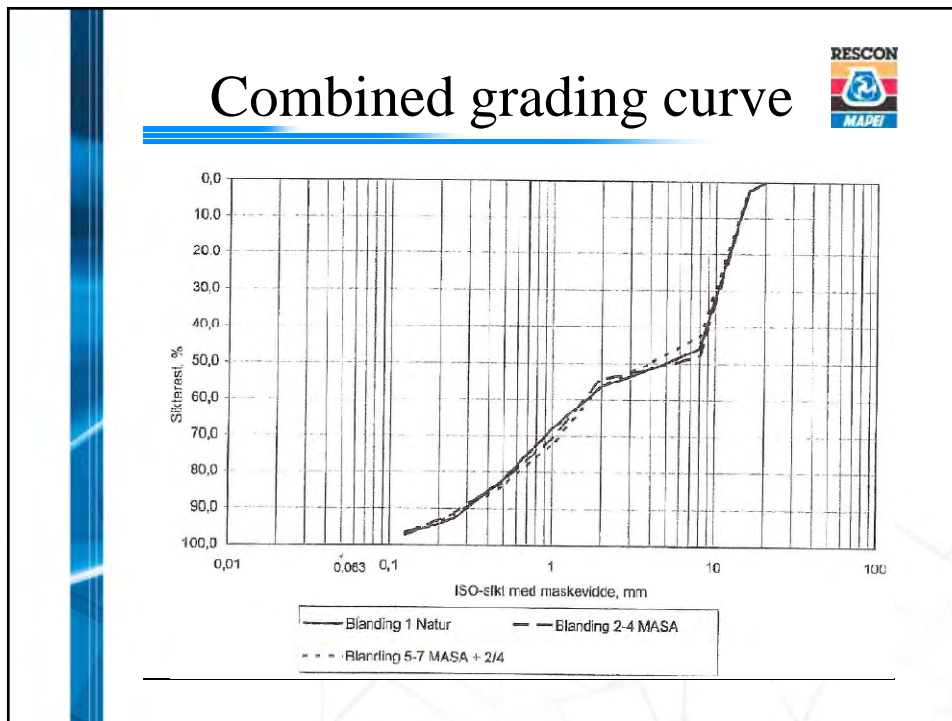

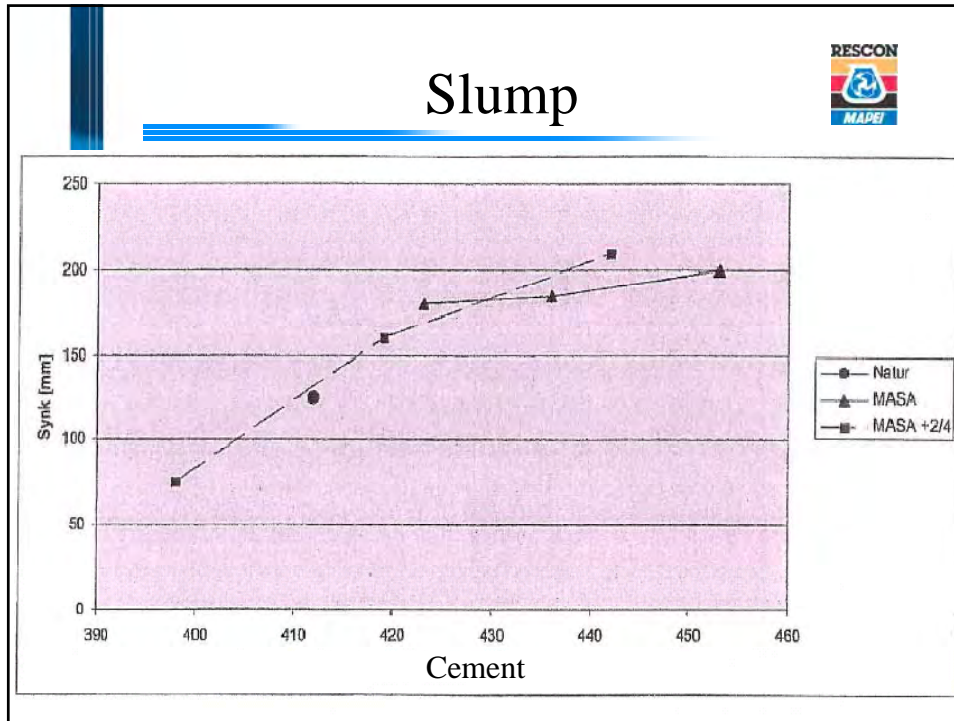

Days	Hours	Compressive strength		
0	0	-	0,0	-
0,2	4	3,5	5,0	2,35
0,3	8	13,6	17,0	11,40
1,47	35	50,3	50,0	0,11
2	48	56,8	57,0	0,05
3	72	63,9	63,0	0,75
7	168	74,0	72,0	3,85
28	672	81,4	85,0	12,69

$f_{c\infty}$	85,0
τ	17
α	0,85
$\Sigma \Delta y^2$	31,2048
R^2	0,9954

$$f_c = f_{c\infty} \cdot e^{\left(-\frac{\tau}{M}\right)^\alpha}$$

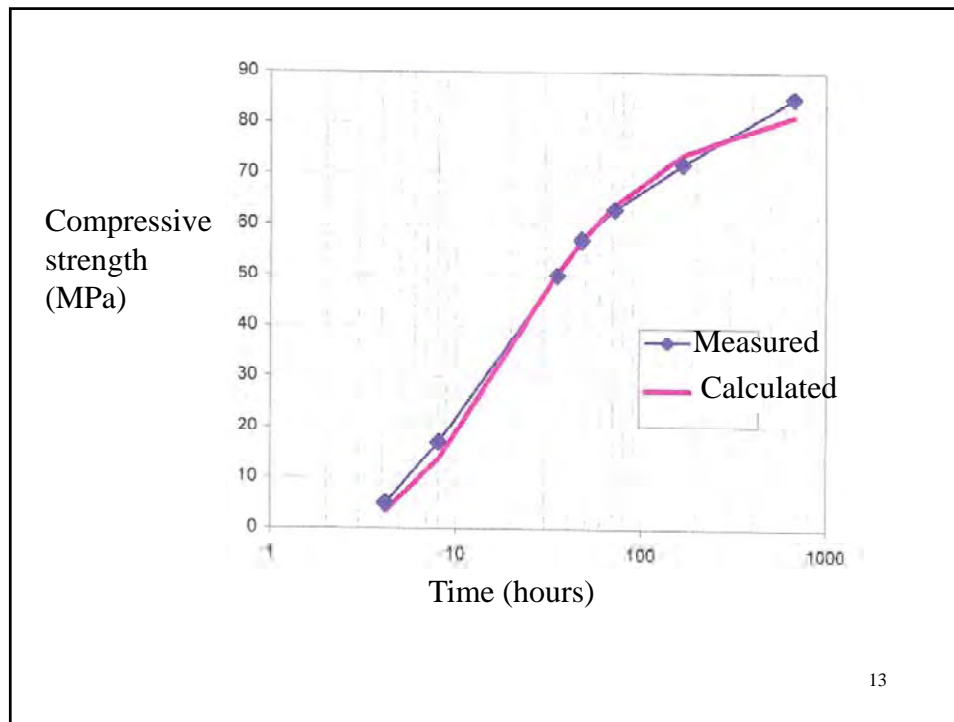

13

Conclusions from lab. trials



- Possible to cast by use of 100% crushed aggregate
- High early strength
- Instability when slump > 220 – probably caused by lack of fine

Full scale casting of concrete element



- Mix containing 100% crushed aggregate (mix nr. 3 from lab. Trials)

Testing of strength development



- Temperature was continuously logged in air, and in concrete element (bottom, mid- and in top reinforcement).
- Temperature log was used to calculate compressive strength
- 3 cylinders was drilled out to test the compressive strength after 5 (normal time for lifting) and 14 hour

High early strenght!



- Strength after 5 ours 18 MPa and after 14 ours 50 MPa ! (correlating to the good result from laboratory tests made by SINTEF)
- The demand for compressive strength by lifting time is - 16 MPa

Casting



- Use of vibration in casting (table)
- The concrete flow and the responding on vibration vas different from the normal – but still OK
- The slump retention vas tested by pouring concrete in 4 buckets and test the slum after 5, 10, 15 and 20 minutes – the slump retention was OK
- The surface of the element was as normal

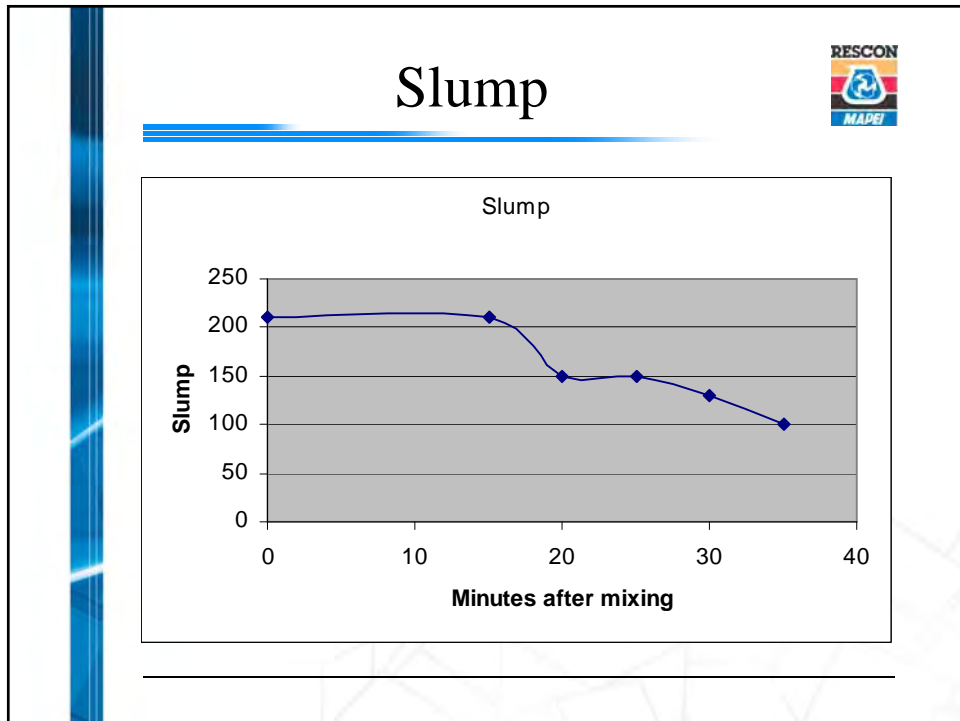
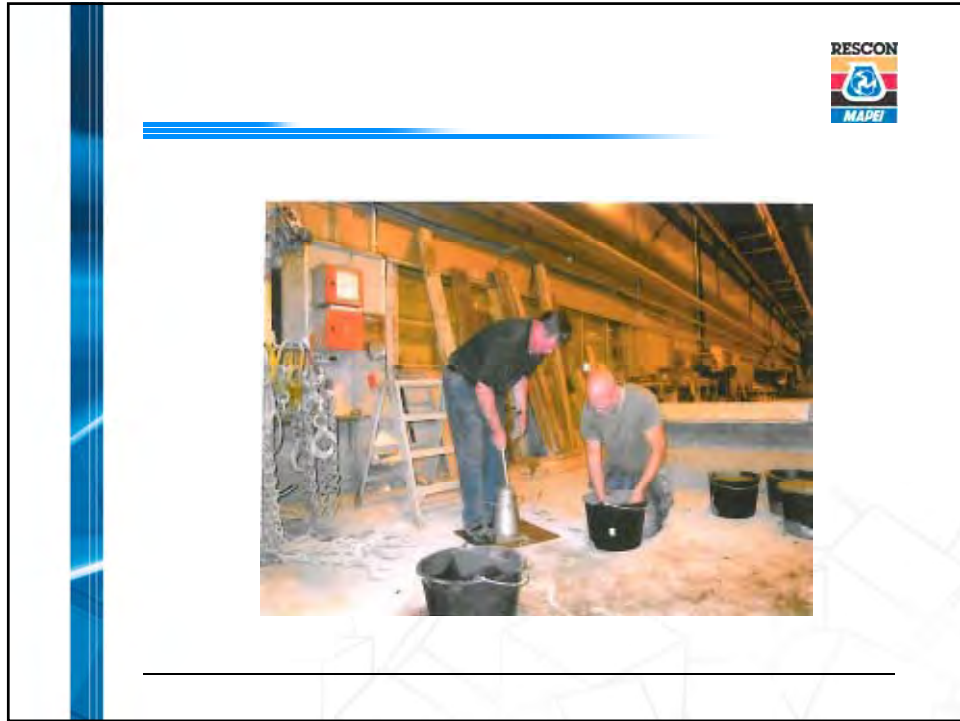

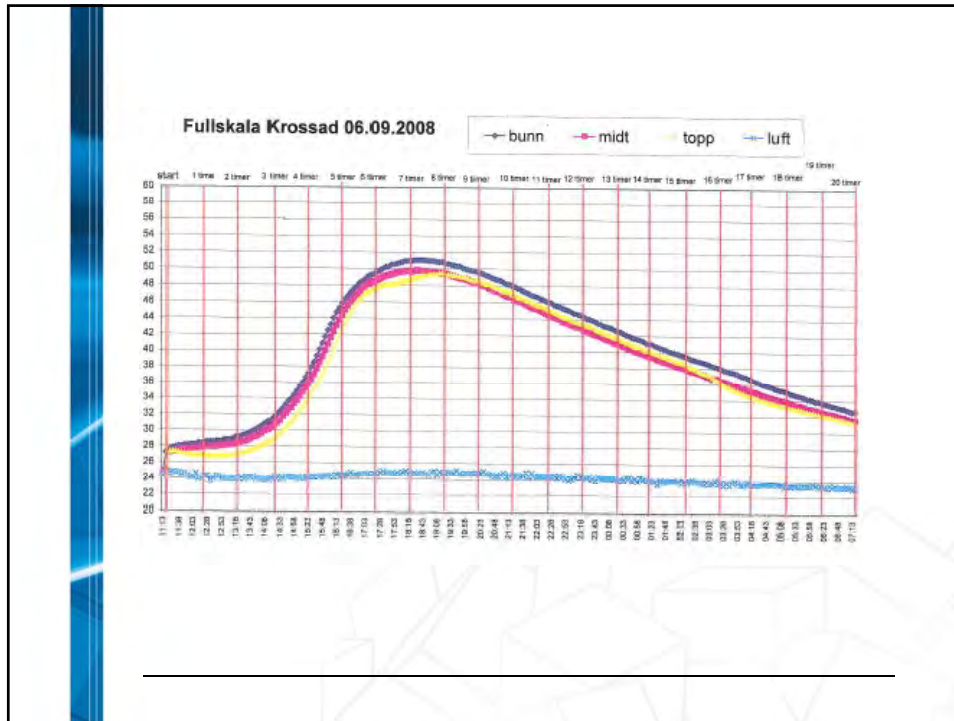

What have we learn



- It is possible to cast wall- element with 100% crushed aggregate, and get a normally good surface
- Standard demands for the crushed aggregate has to be developed and documented accordingly the SS-EN 1262 Ballast til betong (aggregate for concrete)
 - Grain distribution
 - Geometrical shape

Challenges



- Instability with slump > 230
- Testing with filler (<0,063 mm)?
- Testing of new and promising chemical stabilizer – Viskostar 3K
- By use of stabilizer will it be possible to obtain necessary stability with less cement? – would be good for other types of element (example HD-element)
- Further development to obtain a more cohesive concrete and a better slump retention

A brief look into the MAPEI approach
to develop super- plasticizers
for different purposes

24

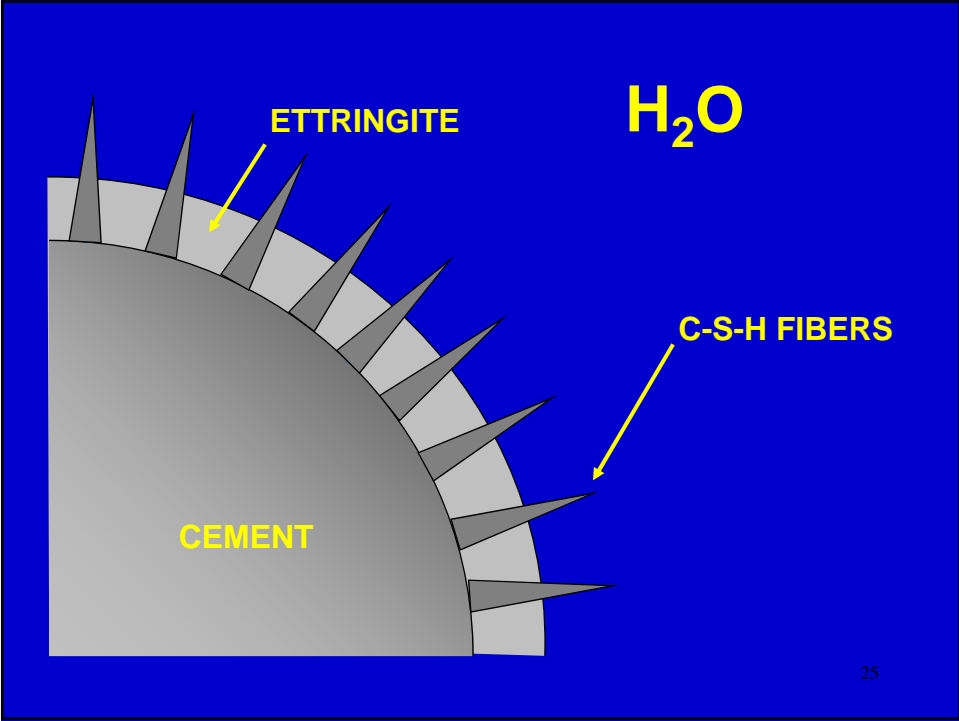

25

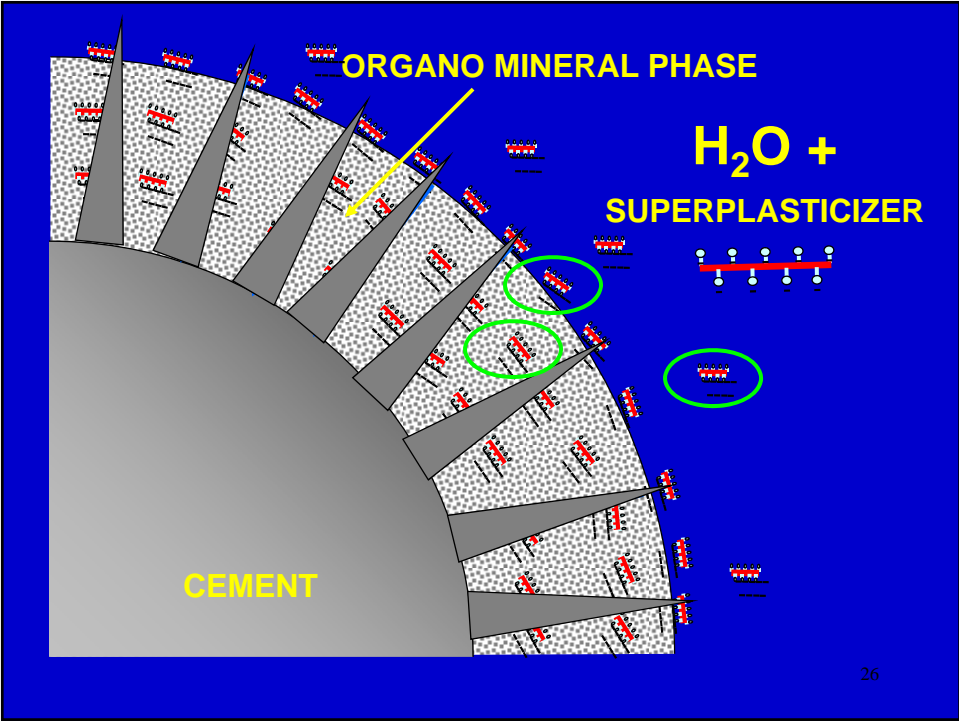

26

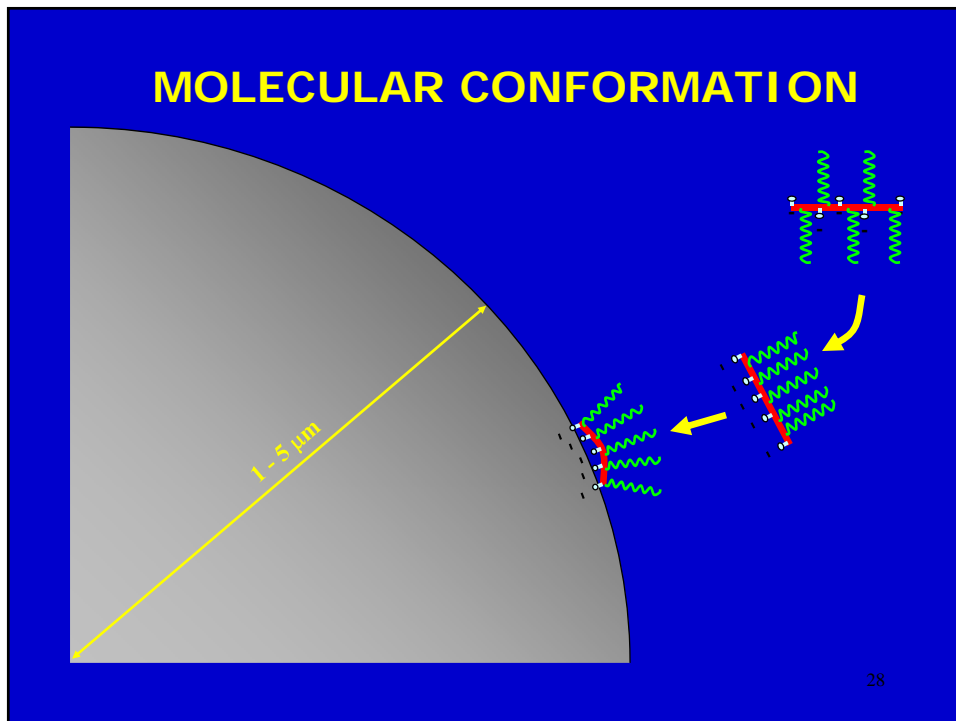
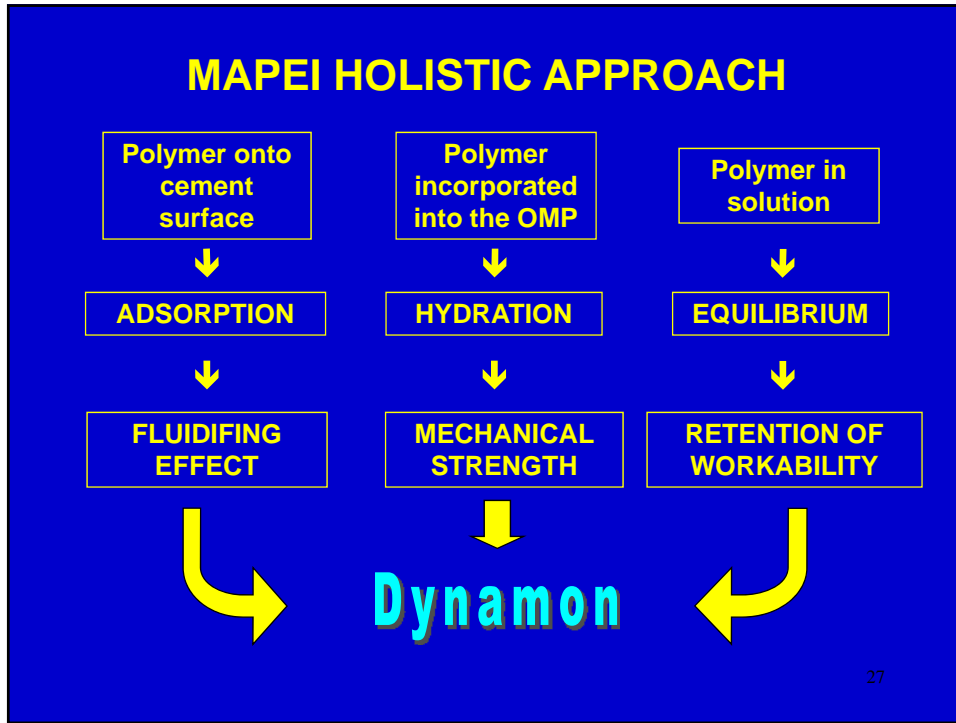

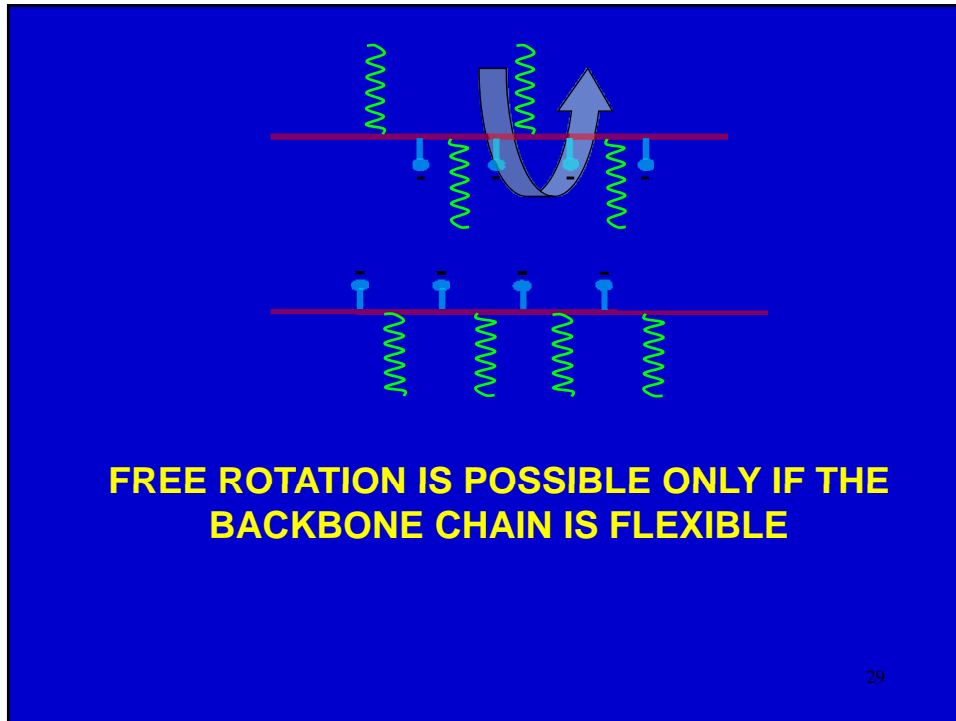

29

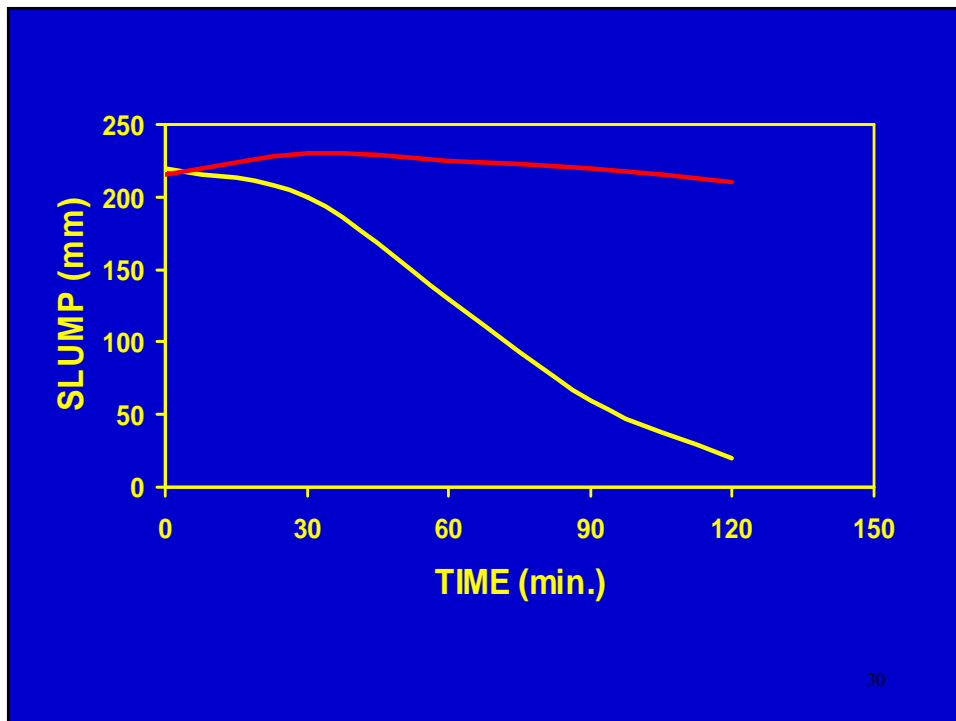

30

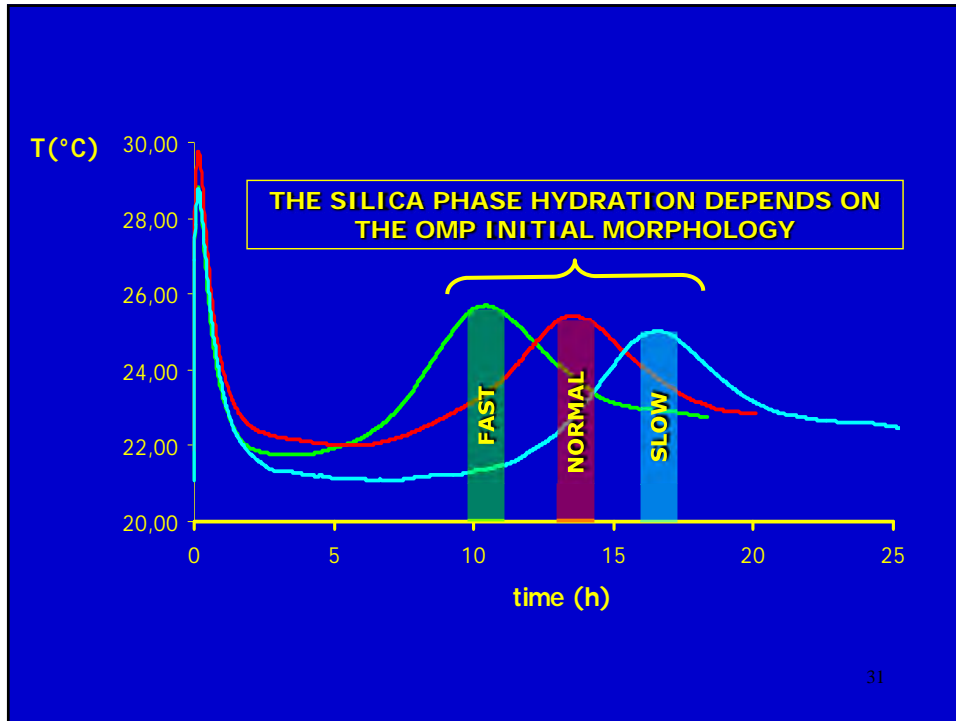



Example of how to evaluate shape of fine aggregate

Sand flow cone NZS 3111:1986

Stavanger Sand Meeting October 2008



Importance of measurement

"I often say that when you can measure what you are speaking about, and express it in numbers, you know something about it; **but when you cannot express it in numbers, your knowledge is of a meagre and unsatisfactory kind.**"

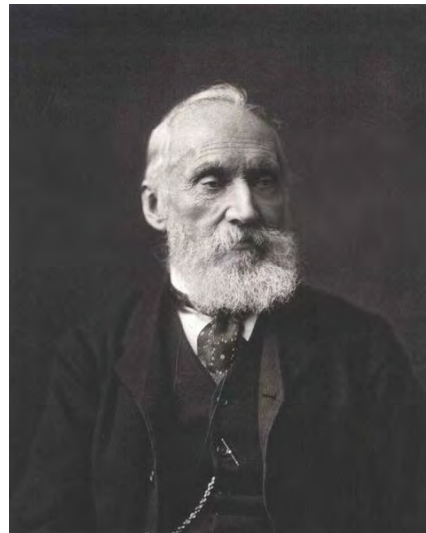

William Thomson, 1st Baron Kelvin (1824-1907)

Source:

http://en.wikipedia.org/wiki/William_Thomson,_1st_Baron_Kelvin

<http://www.webperformancematters.com/journal/2007/5/7/the-importance-of-measurements.html>



What are the requirements for fine aggregate in concrete?

EN12620
EN933-1
Sieve Analysis

EN12620
EN933-9
Methylene Blue
Test

EN12620
EN933-8
Sand Equivalent
Test

ASTM C33
Grading
Deleterious Substances
Soundness

These two sand samples fulfill the grading requirement for fine aggregate to be used in concrete, but definitely behaves differently in concrete mix

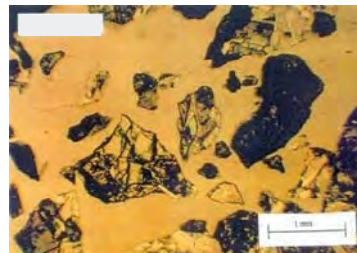
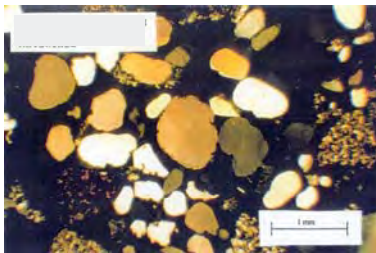

3 | © Metso



A flow cone test according to NZS 3111:1986 measures void content and flow time



- Sample ~ 1000 g (0,38 x SD)
- Minus 4.75 mm
- Flow time in sec.
- Void content of bulk sand
- Two values gives indicator
 - Grading
 - Particle shape
 - Surface texture



Old New Zealand studies

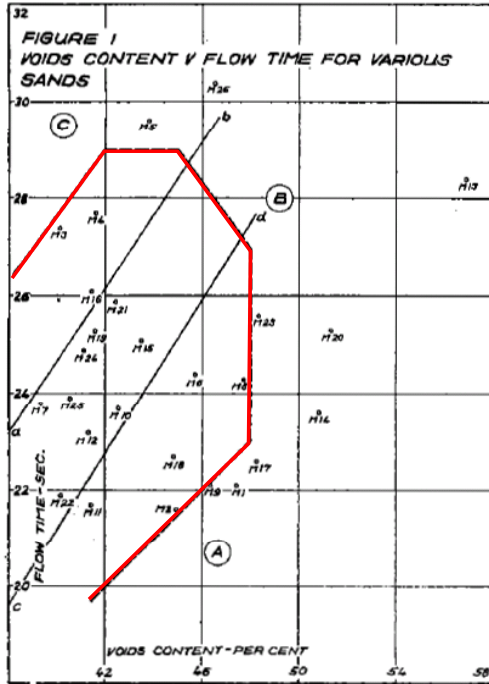

- All sands met the grading requirement of NZS 1051
- The red line differentiates the sands that were suitable and non suitable to be used in normal concretes
- Dots lying outside the line were considered unsuitable because
 - they produced harsh concrete or
 - their water demand was excessive



Effect of particle fragmentation on bulk density and void content

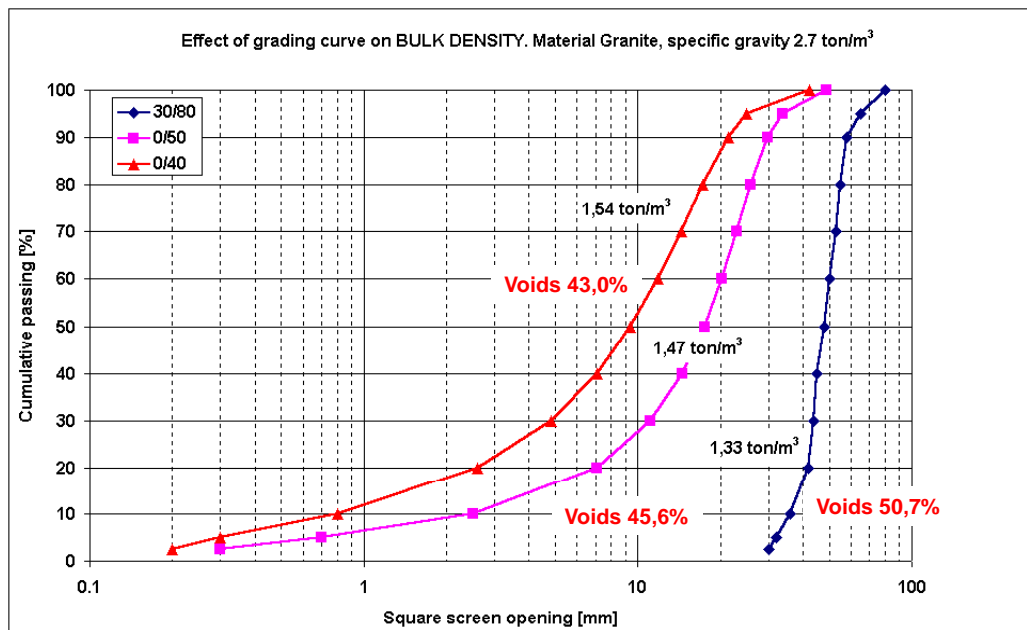

Metso experience

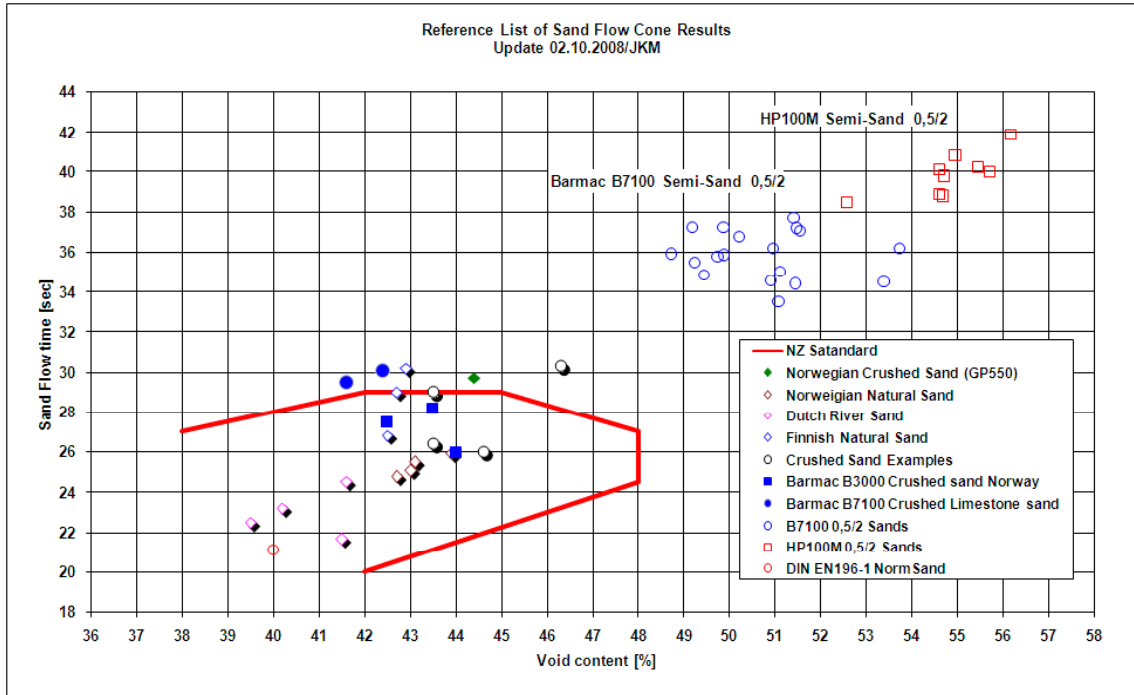

Importance of controlling minus 75 micron content

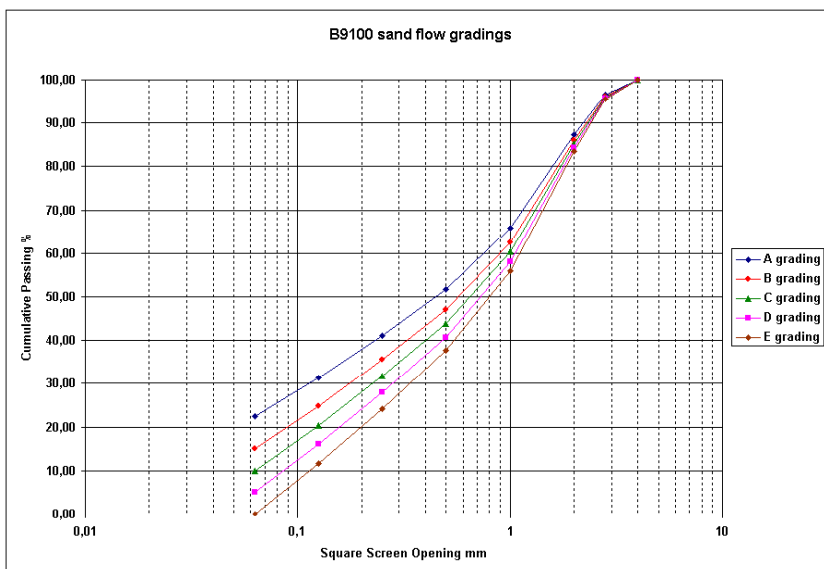

A grading = Original end product ,
Screen mesh size 1,5 x 6 mm
B grading = Modified filler content = 15-%
C grading = Modified filler content = 10-%
D grading = Modified filler content = 5-%
E grading = Modified filler content = 0-%



Sand flow cone results A-B-C-D-E

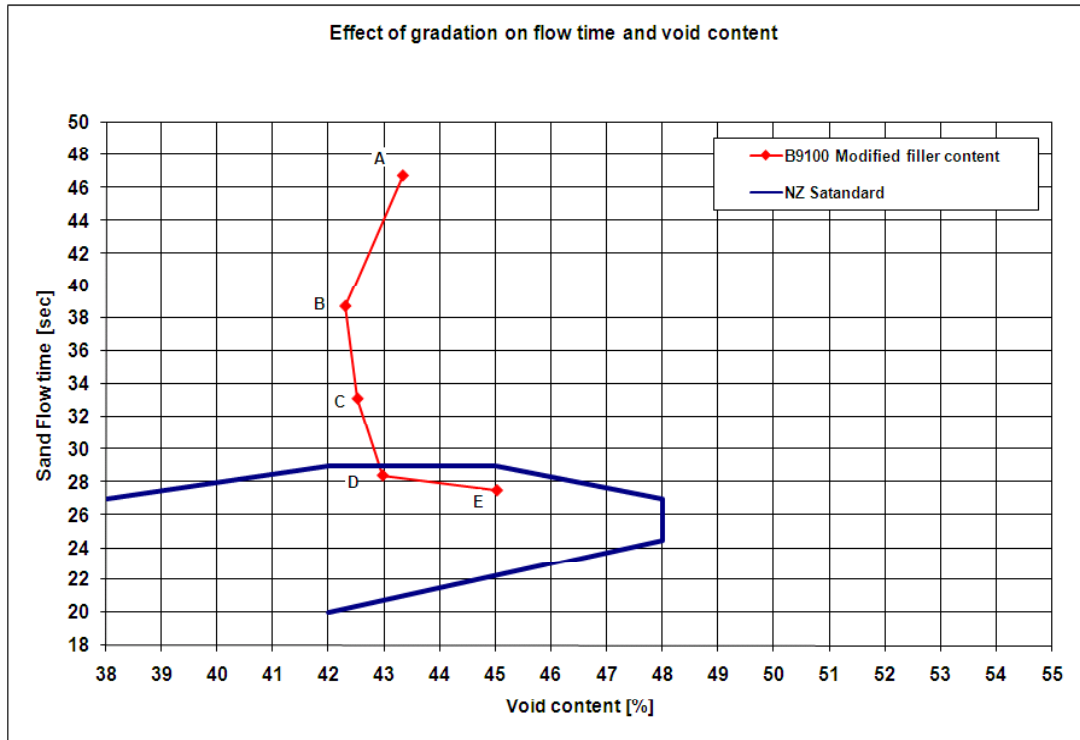

Conclusion

- Too often crushed fine aggregate has been described as waste material
 - There are ways to process the sand and get equal performance to natural sand in concrete mixture
- New methods need to be developed to estimate and measure the performance of sand in concrete

Abstract

Topic: **Characterization and testing of fines**

Title: **Characterization of crushed rock sands in Sweden**

Authors: Gram, Hans-Erik, Lagerblad, Björn and Westerholm, Mikael

Rock quarries in Sweden are mainly in granitic rocks and the main product is stone for road construction and asphalt paving's. The main product is coarse aggregate and the crushing processes aim mainly at improving stone quality. Fine aggregate and fines are used in different applications without any further processing and they are often considered as less valuable and are sometimes deposited.

Presently the use of natural sands is limited due to environmental reasons and in the future it will be difficult to find natural sand for concrete production. The only realistic alternative to natural sand is crushed rock. It is already well known how to use crushed rocks as coarse aggregate in concrete but the knowledge regarding the fine aggregate is limited. Thus the properties of crushed fine aggregate (0-2 mm) in concrete has been studied in a national project (MinBaS 2003-2005). It was shown that differences in aggregate shape, grading and surface texture largely influence the properties of concrete. Both the properties of the fresh and of the hardened concrete were negatively influenced when the natural aggregates were replaced. The influence of the different products did, however, vary considerably. With some fine aggregate it was possible to replace the natural aggregate almost directly while other caused big problems.

Presently research is going on in two new national projects, MinBaS II and STEM, (2007-2011). In the first project methods to improve the properties of fine aggregates are studied. In the second project methods for how to overcome the problems in concrete proportioning is studied. The aim is to develop an expert system for mix design of concrete and to elaborate recommendations for crushed sands for concrete production. Besides standardised or well established test methods other characterisation methods are used, e.g. BET-surface determination, Methylene blue test, sand equivalent test, laser sieving, particle packing, flow tests, flakiness index and image analysis. The results of these measurements are correlated with rheological tests on micro-mortars, mortars and concretes.

Characterization of crushed Rock sands in Sweden

Hans-Erik Gram
Björn Lagerblad
Mikael Westerholm

Cemeta
CBI Betonginstitutet
CBI Betonginstitutet



CEMENTA
HEIDELBERGCEMENT Group

DISPOSITION

- Introduction – Background
- Fines
- Sands
- Conclusions

Gram, Lagerblad, Westerholm – Stavanger October 2008



CEMENTA
HEIDELBERGCEMENT Group

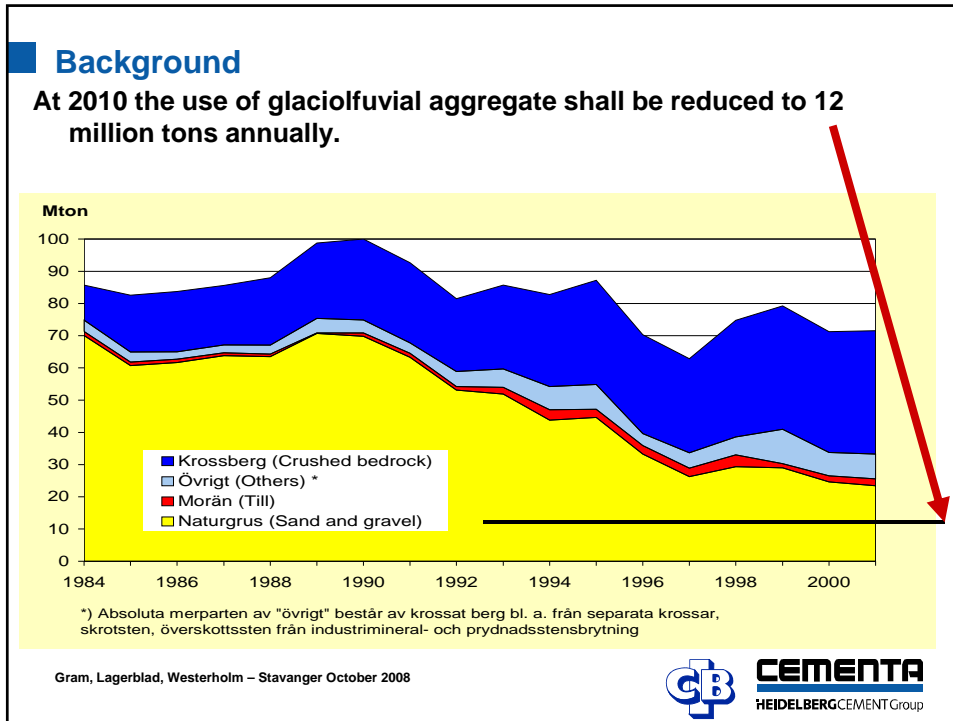

- Background**
- The sources of well graded and round particles in glaciofluvial eskers have been used up in some parts of Sweden.
 - Crushed bedrock seems to be the only realistic alternative.
 - No problem to use crushed stones – but crushed sands are more complicated.
- Gram, Lagerblad, Westerholm – Stavanger October 2008
- GB** **CEMENTA**
HEIDELBERGCEMENT Group

Background

- 2003 – 2005 MinBaS "Big" national research project
- 2007 – 2011 STEM Continued research on Characterization of crushed sands, elaboration of guidelines for opening of new quarries, elaboration of guidelines for concrete producers using crushed sand and development of an expert system for concrete mix design.
- 2007 – 2011 MinBaS II New research in Developments of Crushing Technology, air classifiers but also research in Durability – like shrinkage, ASR and frost resistance.

Gram, Lagerblad, Westerholm – Stavanger October 2008

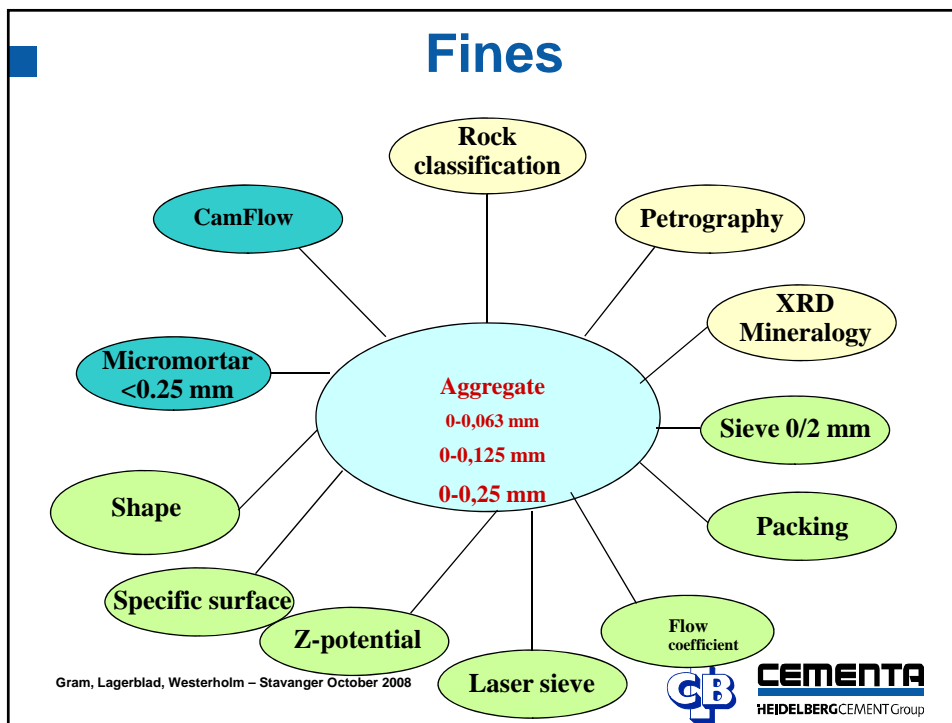

Important properties of the fines

Particle size distribution

Shape **Surface**

Granite is by definition rich in free Quartz. But it also contains various other minerals. Particle shape, size distribution and texture depends on variations in the Granite Family.

Gram, Lagerblad, Westerholm – Stavanger October 2008

The Granite family

Classification after mineral content

Different Granites produce different particle properties!

Gram, Lagerblad, Westerholm – Stavanger October 2008

Mineral composition (0.125-0.25 mm) [%]

Aggregate	<u>Minerals</u>				<u>Rock fragments</u>		
	Quartz	Feldspar	Biotite	Hornblende	Salic	Mafic	Other
C10	33.0	54.3	0.6	0.3	10.0	1.0	-
C9	28.5	22.0	1.5	-	44.0	3.5	-
N1	37.6	20.3	2.3	1.6	32.0	5.6	0.3
C4	39.0	33.3	4.0	-	20.0	0.6	2.0
C1	34.5	23.0	7.5	27.5	3.0	4.0	0.5
C5	34.0	42.0	11.0	-	8.0	2.0	-
C2	29.5	16.5	15.0	19.5	10.0	9.5	-
C12	18.0	33.0	17.0	11.3	12.3	8.0	-
C8	44.0	31.0	18.0	1.5	4.0	1.0	-
C6	46.0	22.0	19.6	0.6	9.3	2.0	-
C7	25.0	30.3	20.3	-	17.3	5.6	-
C13	39.2	18.0	23.6	2.0	12.0	4.0	1.2
C11	21.3	21.3	25.0	15.0	10.3	4.6	2.3
C3	22.0	21.0	42.0	8.0	10.0	2.0	-

Gram, Lagerblad, Westerholm – Stavanger October 2008



Particle size distributions – a lot of fines!

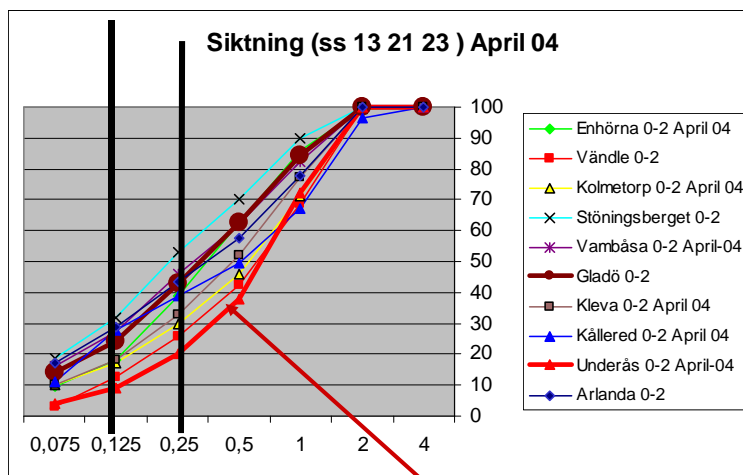

Natural sand

Gram, Lagerblad, Westerholm – Stavanger October 2008



The content of fines is often high – or very high!



Gram, Lagerblad, Westerholm – Stavanger October 2008







Sieve openings and weights or volumes

Quantity	Particle Shape	Dimensions	Volume (V)
4 particles	Sphere	$r = 2\text{mm}$	$V = 33,5$
1 particle	Rectangular prism	$a = 4\text{mm}$ $b = 4\text{mm}$ $c = 8\text{mm}$	$V = 128$
40 particles	Thin rectangular prism	$a = 0,1\text{mm}$ $b = 4\text{mm}$ $c = 8\text{mm}$	$V = 3,2$

Arrows from all three particle types point to a box labeled "Sieve 4 mm".

Gram, Lagerblad, Westerholm – Stavanger

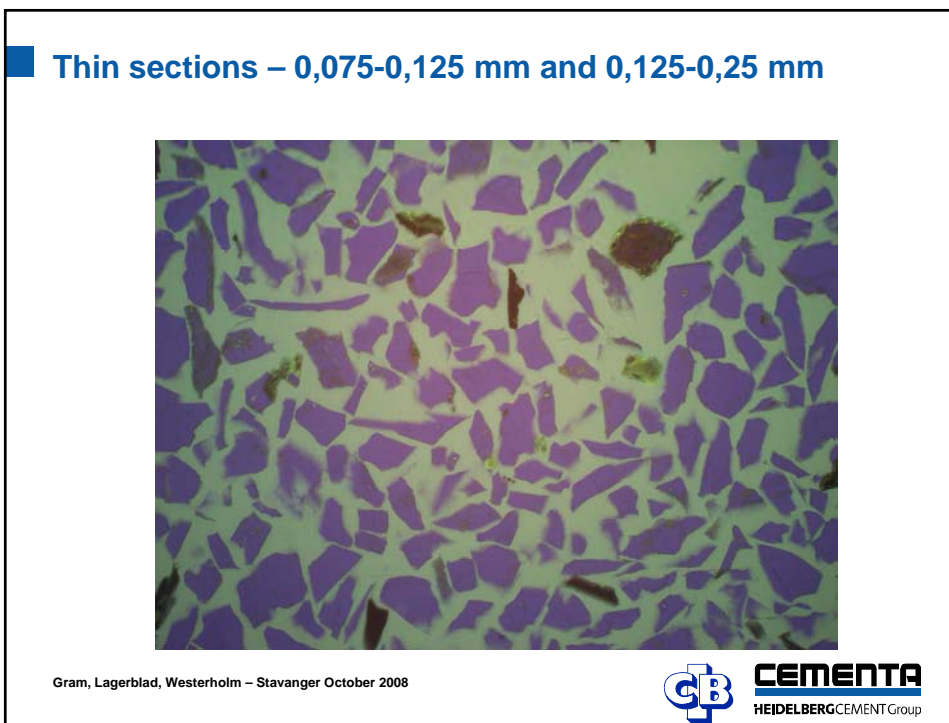
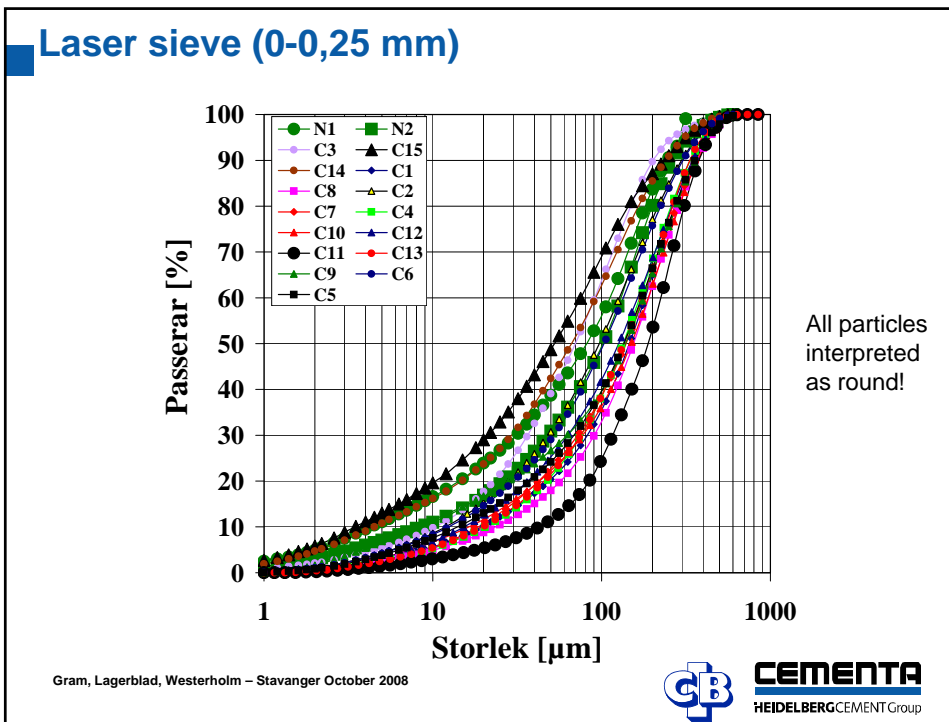



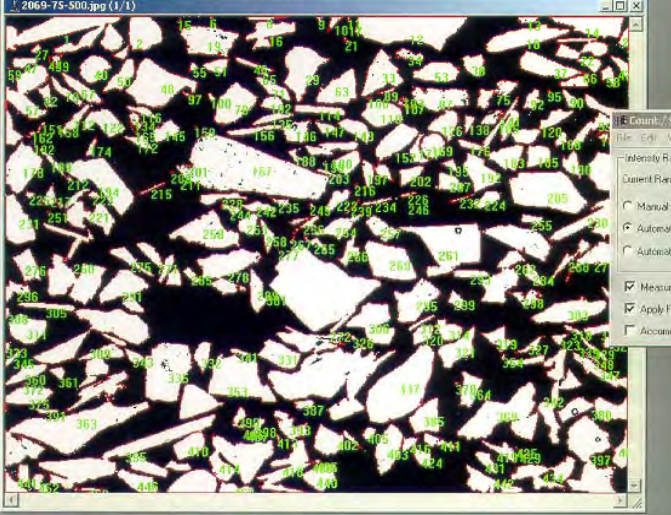

All grains are measured

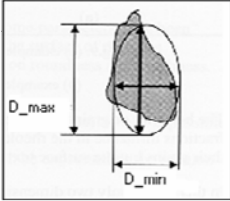

F-aspect



Gram, Lagerblad, Westerholm – Stavanger October 2008



CEMENTA
HEIDELBERGCEMENT Group

**F-aspect made with SEM- analysis
0,075-0,125 mm and 0,125 – 0,25 mm**

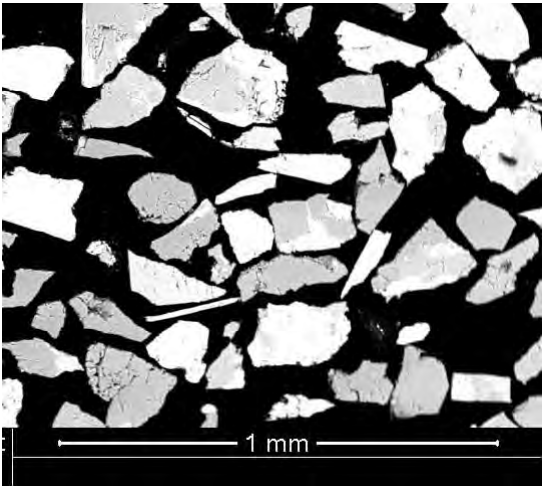

Gram, Lagerblad, Westerholm – Stavanger October 2008



CEMENTA
HEIDELBERGCEMENT Group

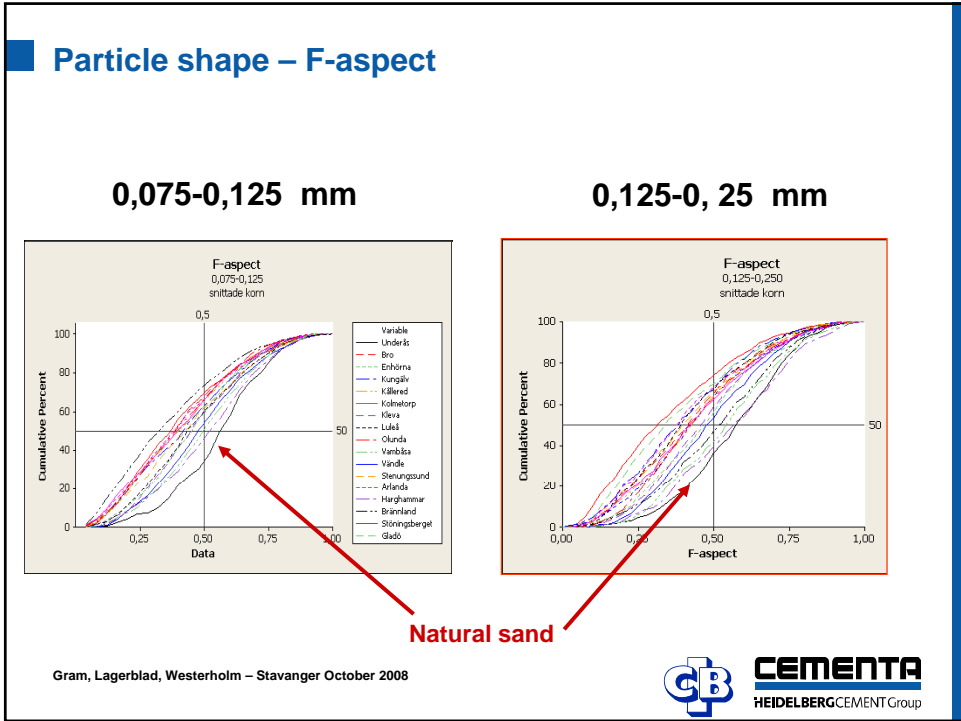

**Determination of loose bulk density and voids
0,063-0,125 mm and 0,125-0,25 mm**

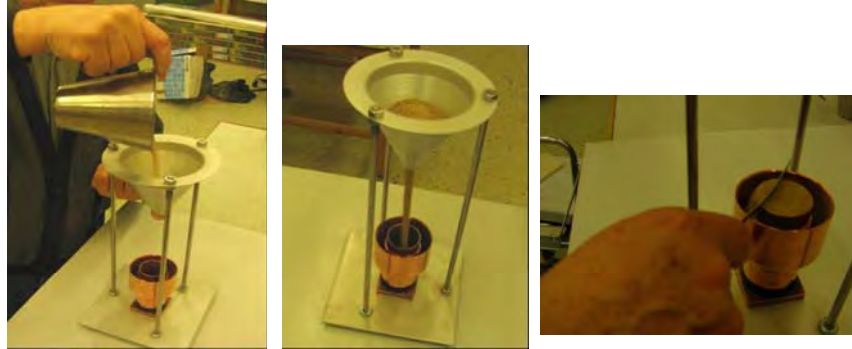

Gram, Lagerblad, Westerholm – Stavanger October 2008



Bulk density and Flow coefficient – 0,063-0,125 mm

	Loose packing	Flow time
A	35,4	stuck
B	38,8	5,50
C	38,9	stuck
C - VSI	40,5	4,36
D	44,7	4,03
Natural sand	42,4	4,33



Gram, Lagerblad, Westerholm – Stavanger October 2008



Specific surface - BET

Quarry	BET-surfa.
N1	2650
K1	976
K2	2800
K3	840
K4	2490
K5	520
K6	610
K7	1150
K8	4140
K9	890
K12	870
K13	920
K14	1030
K15	780
K18	960

Gram, Lagerblad, Westerholm – Stavanger October 2008

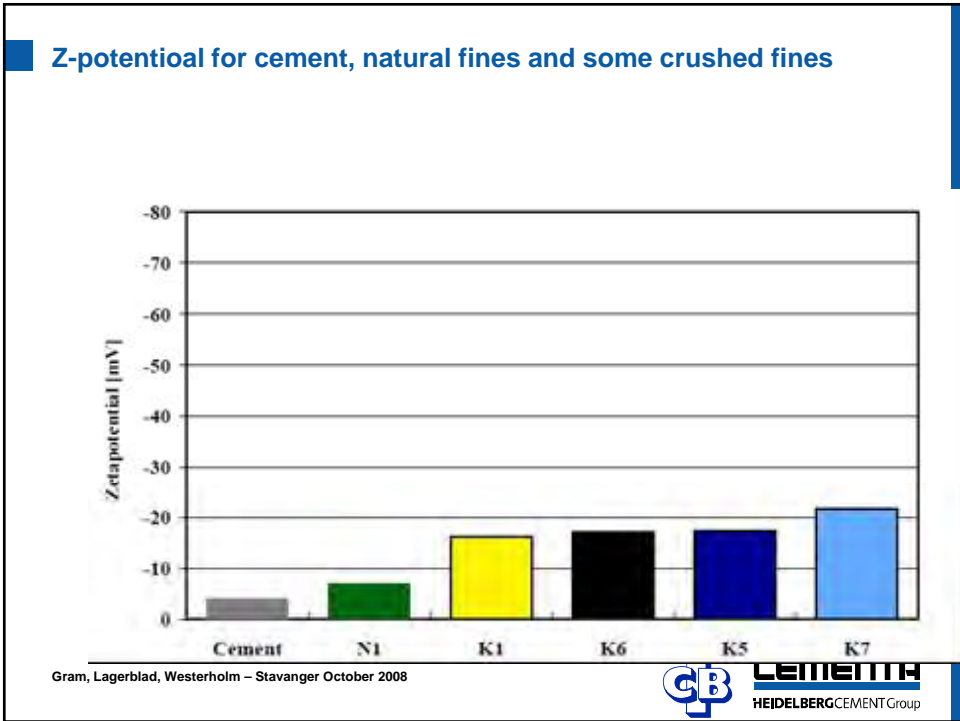

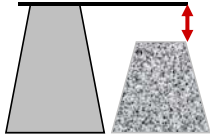

Why Rheology?

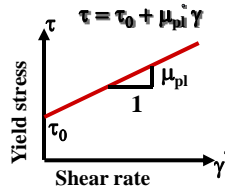

Adam's Cone - Slump

Describes workability with **one** parameter



Viscometer

Describes workability with **two** parameters

Gram, Lagerblad, Westerholm – Stavanger October 2008



Micromortar rheology



Haake Rotovisco CV20

➤ Viscometer

- Concentric cylinders
- Serrated inner cylinder

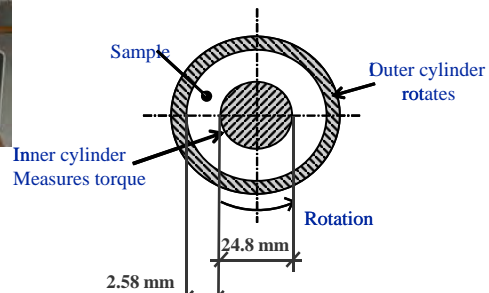

Gram, Lagerblad, Westerholm – Stavanger October 2008



Definitions

Micromortar

Cement

Water

Additives

Fines ≤ 0.25 mm

Gram, Lagerblad, Westerholm – Stavanger October 2008



Micro mortars (particles <0,25mm)

Yield Stress

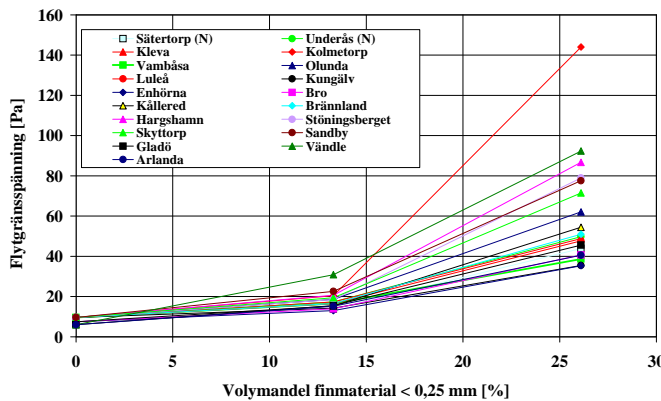

The effect of unfavourable particle shape and size distribution is bigger the more fines there are.

Gram, Lagerblad, Westerholm – Stavanger October 2008



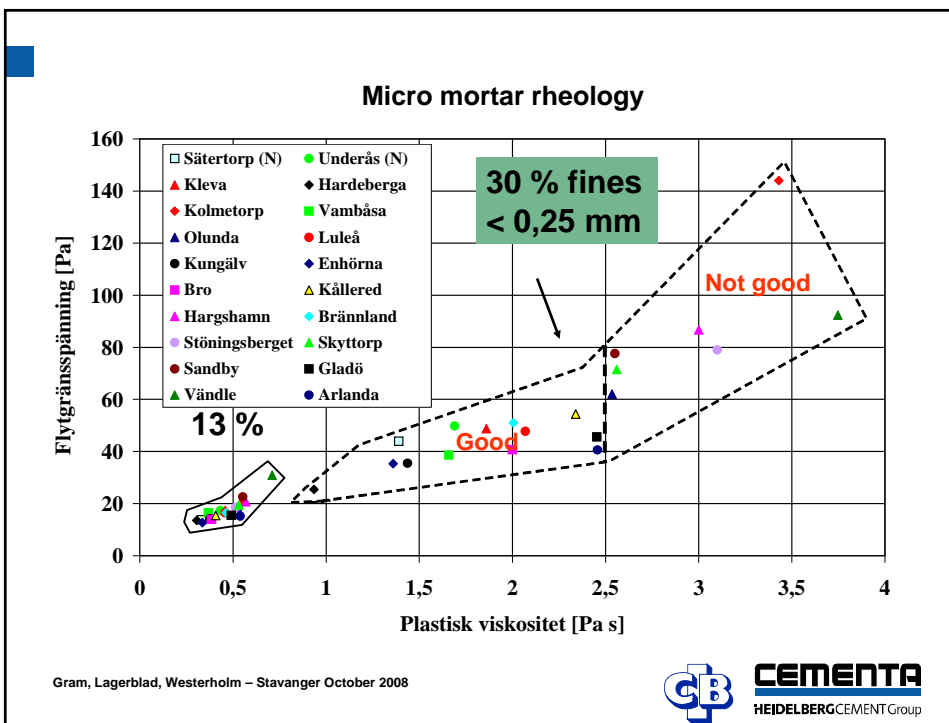
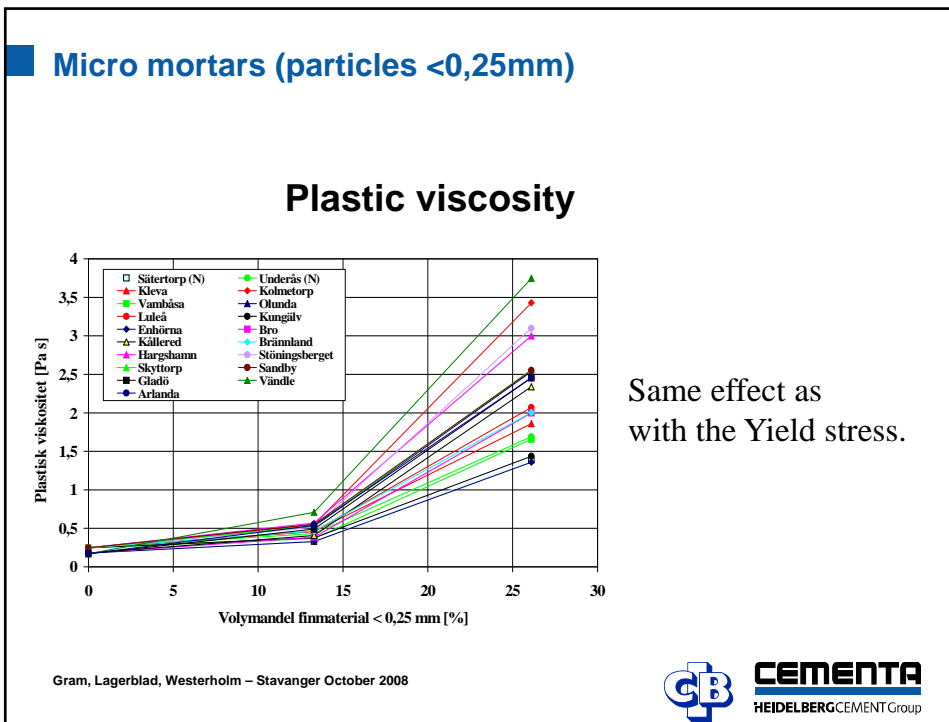

CamFlow – micro mortar

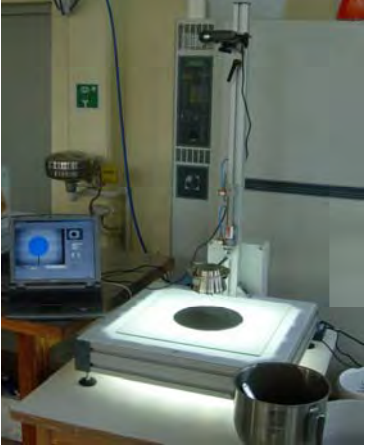

Gram, Lagerblad, Westerholm – Stavanger October 2008



CEMENTA
HEIDELBERGCEMENT Group

CamFlow – Cone has 100 mm bottom diameter



Gram, Lagerblad, Westerholm – Stavanger October 2008



CEMENTA
HEIDELBERGCEMENT Group

CamFlow

Tabell 1 CamFlow studies on micro mortar, particles < 0,125 mm
Water to powder ratio is 0,40.

Material	Diameter in mm
100% Byggcement	175
25% Limus 70 och 75% Byggcement	192
50 % Limus 70 och 50 % Byggcement	236
25% ballast 1 och 75% Byggcement	159
25% ballast 2 och 75% Byggcement	166

Limestone powder, Limus 70 has a lower water demand than Cement.
Crushed sands, samples 1 and 2 require more water than Cement.

Gram, Lagerblad, Westerholm – Stavanger October 2008

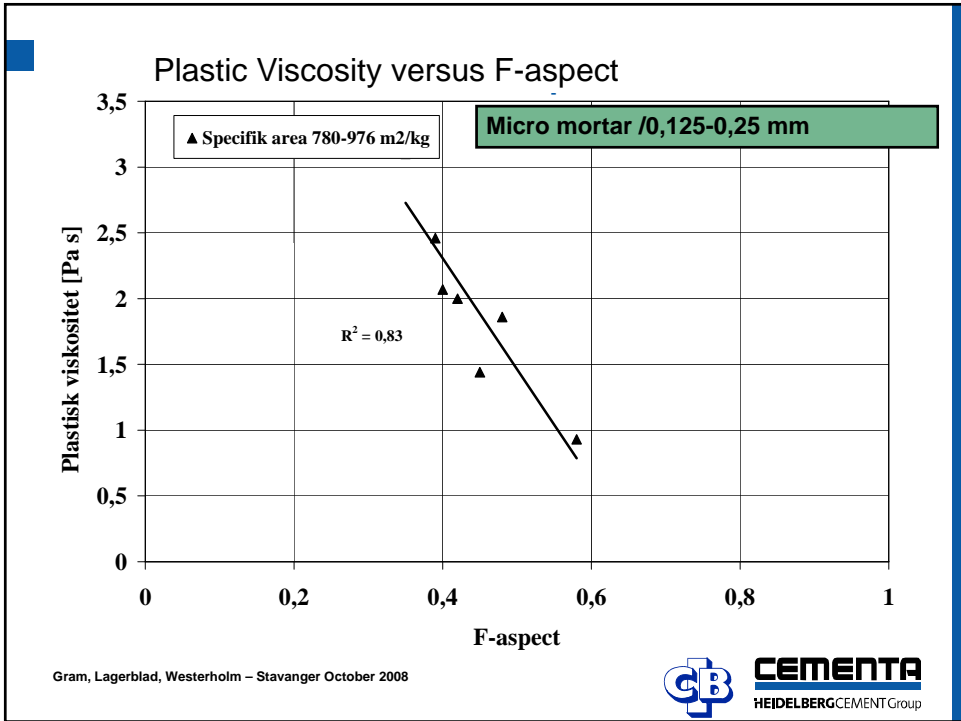

Micromortar rheology: fines quality

- A good correlation between the **specific surface area** of the fines and the **yield stress** and **plastic viscosity** of the micromortar was observed.
- Larger specific surface area results in a higher yield stress and plastic viscosity.
- The particle shape of the fines mainly influence the plastic viscosity of the micromortar.

Gram, Lagerblad, Westerholm – Stavanger October 2008



Grains < 2 or 4 mm

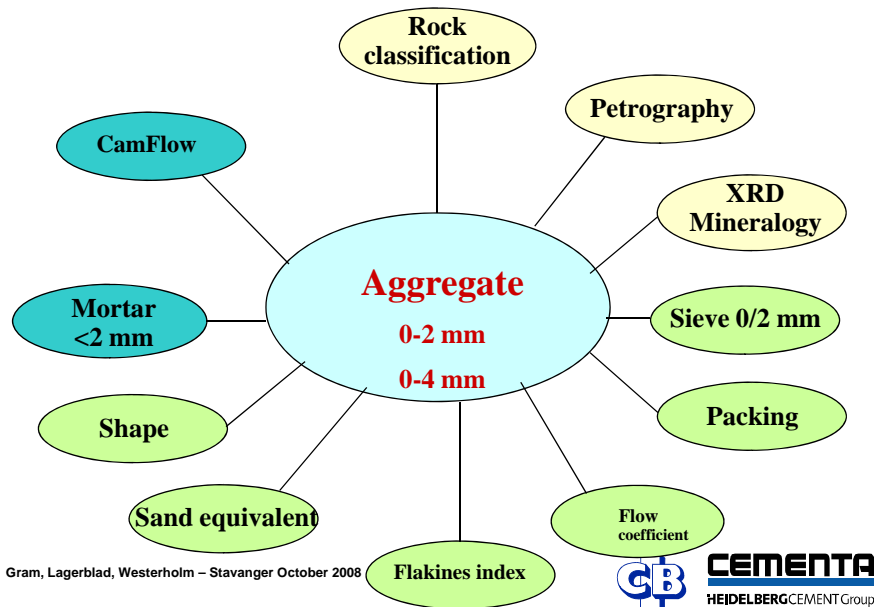

Gram, Lagerblad, Westerholm – Stavanger October 2008



**CamFlow – utbredning
kurva 2**

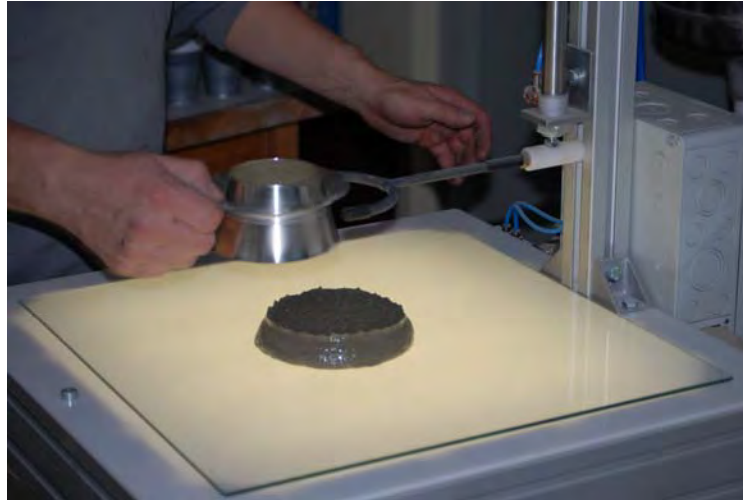

Gram, Lagerblad, Westerholm – Stavanger October 2008



**CamFlow Kurva 2
0,063 – 2 mm**

Sample no	Diameter, mm
1	109 (111,5)
2	135 (137,3)
3	118,5
4	119,7
5	155
7	108,4



Gram, Lagerblad, Westerholm – Stavanger October 2008



Effect of VSI on grains < 4 mm
 Fixed particle size distribution

	Before VSI	After VSI
Camflow – Curve 2	118,5 mm	135 mm
Flow time/packing 0,063-0,125	x/38,9	4,36/40,5
Flow time/packing 0,125-0,25	4,33/39,5	3,69/42,2
Flow time/packing 0,25-0,5	3,78/41,4	3,52/43,7
Flow time/packing 0,5-1	4,33/42,7	4,03/45,5
Flow time/packing 1-2	5,52/44,1	5,29/48,0
Flow time/packing 2-4	x/46,8	x/50,8
Flow time/packing 0,063-2	4,0/50,5	3,54/54,2

Gram, Lagerblad, Westerholm – Stavanger October 2008





Mortar rheology



- Contec 4-SCC Viscometer
 - Concentric cylinders
 - Ribbed inner cylinder
 - Measurement on suspensions with up to 20 mm aggregate

Gram, Lagerblad, Westerholm – Stavanger October 2008



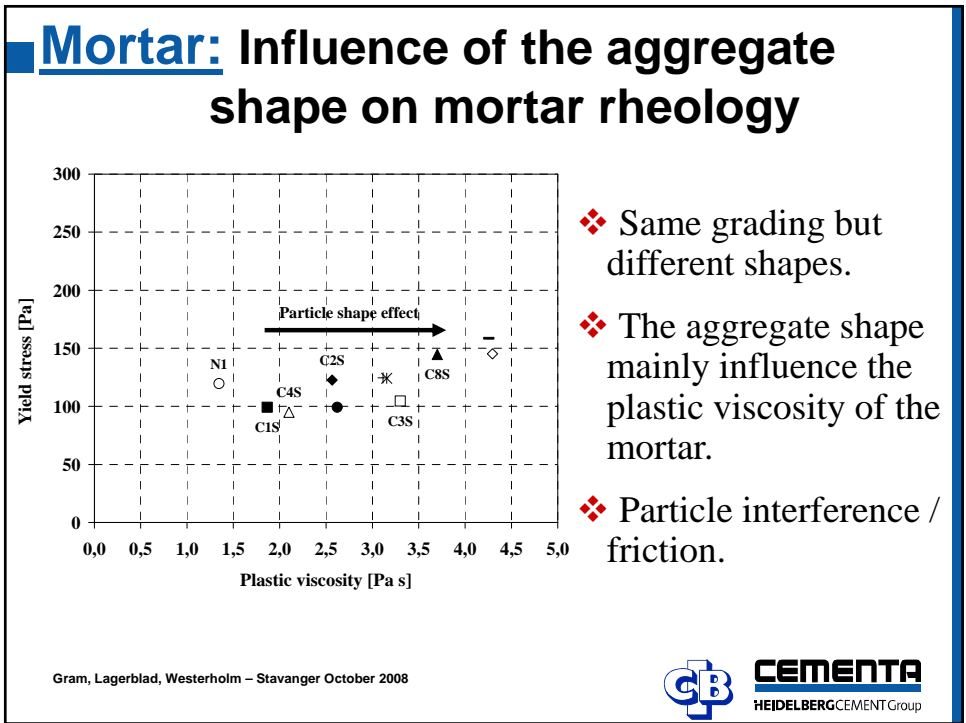
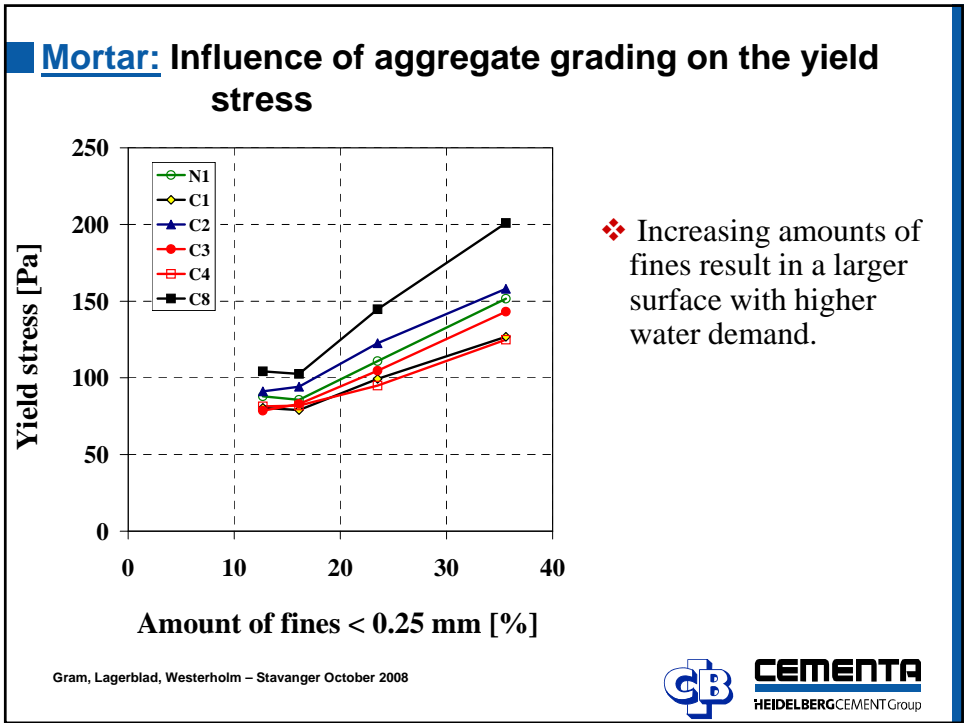

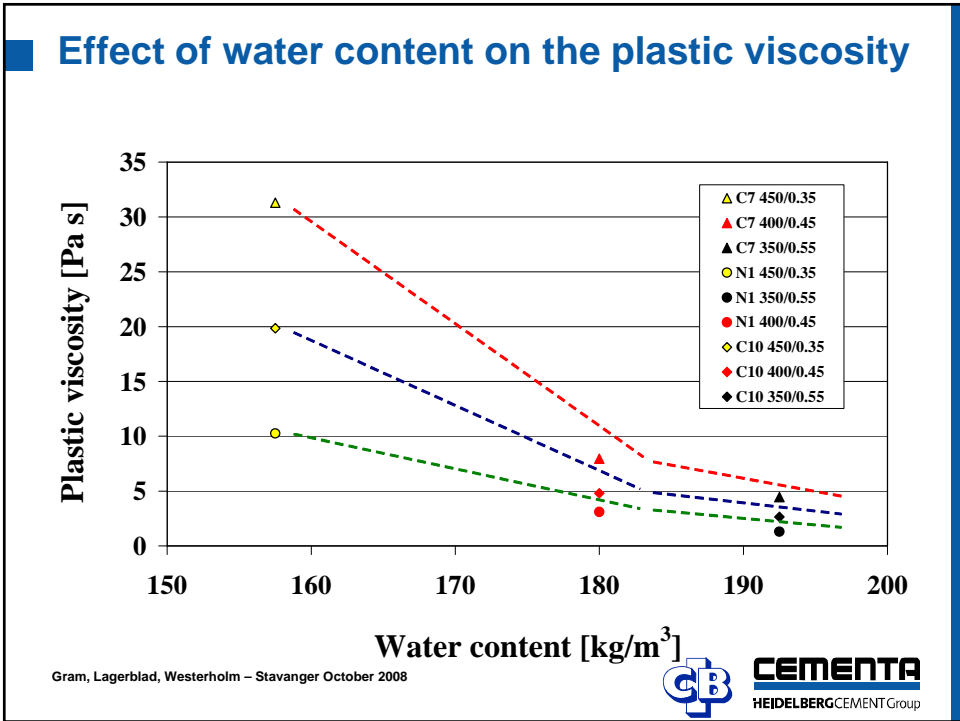
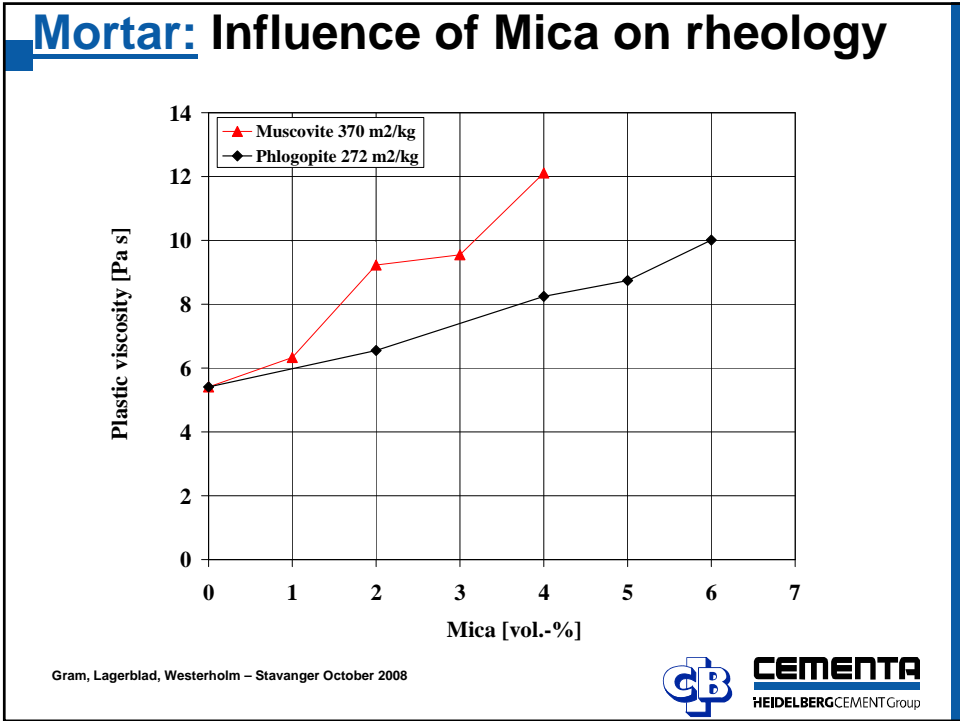

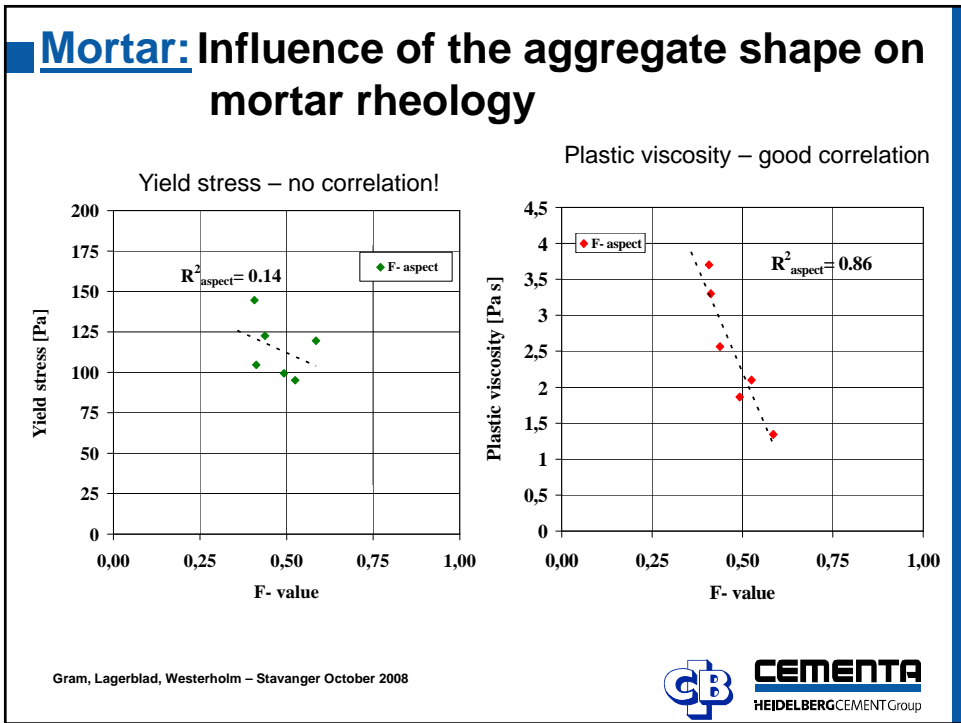
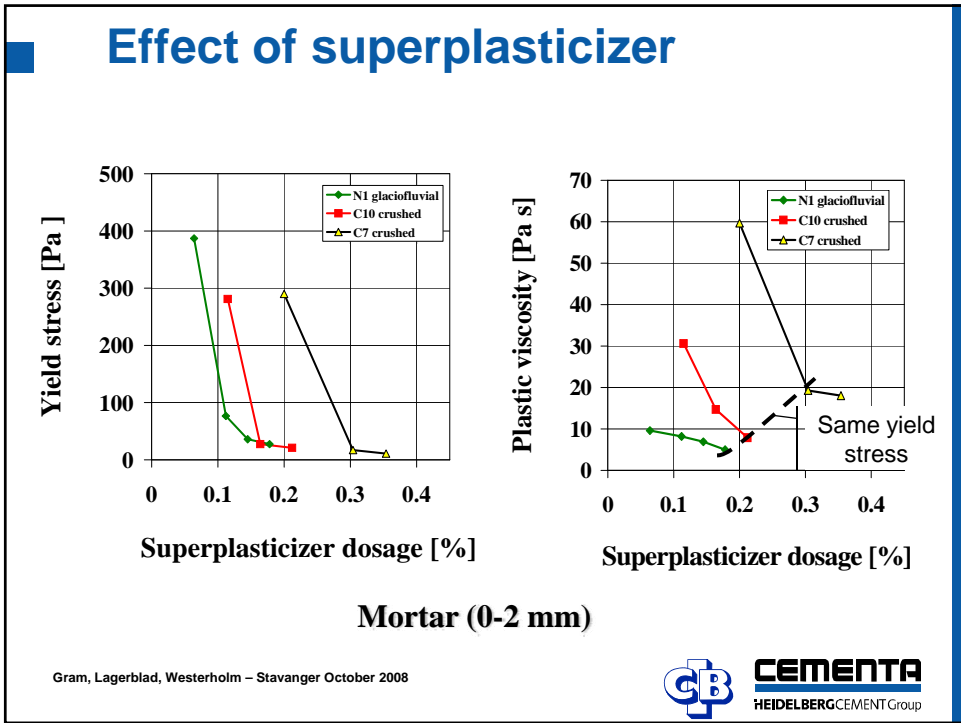
Conclusions – particle shape

Flowable concrete

Gram, Lagerblad, Westerholm – Stavanger October 2008

Conclusions

Particle size distribution

Shape	F-aspect > 0,6.....
Surface texture	Smooth
Particle size distribution	As even as possible, fines < 10-15%

Gram, Lagerblad, Westerholm – Stavanger October 2008

Conclusions

- The "quality" of crushed sands is very variable depending on source.
- The properties of some crushed sands are similar to those of glaciofluvial aggregates.
- Rheological studies are a powerful tool to characterize the properties of fine aggregate.
- One reason for problems with crushed sands in Sweden is their flakiness.

Gram, Lagerblad, Westerholm – Stavanger October 2008



Effect of super plastiziser on mortar (0-2 mm)

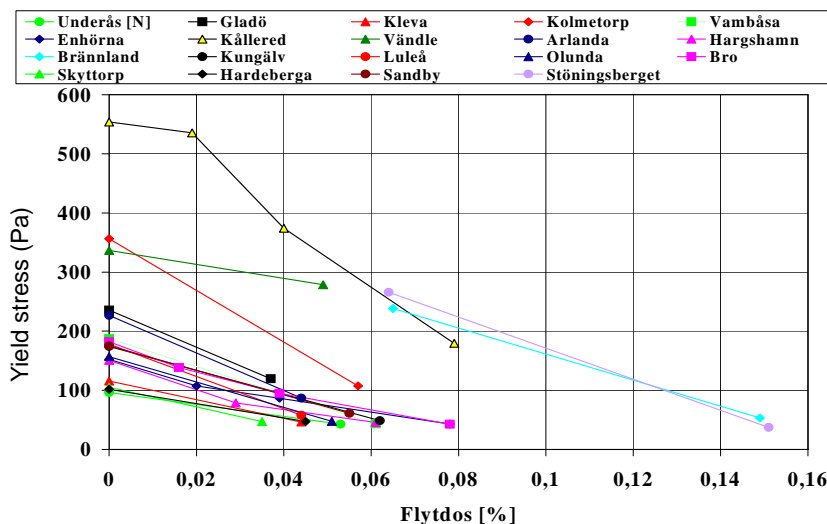

Gram, Lagerblad, Westerholm – Stavanger October 2008



A FLAKINESS TEST FOR FINE AGGREGATE

Chris Rogers

Post Office Box 185, 161 Centre Street, Beeton, Ontario, Canada, L0G 1A0

E-mail rogers.chris@rogers.com

Phone 905-729-4768

Bob Gorman

Soils and Aggregates Section, Materials Engineering and Research Office

Ministry of Transportation, Downsview, Ontario, Canada, M3M 1J8

E-mail bob.gorman@ontario.ca

ABSTRACT

The presence of excessive amounts of flakey particles in the coarser fractions of fine aggregate are thought to be the cause of two cases of 'Uncompactable Hot Mix Asphalt' that have occurred in Canada. This paper describes the development of a test for measuring the amount of flakey particles in fine aggregate. Commercially available slotted sieves for testing grain or seeds are used. Material in the pass 4.75 mm to 2.36 mm fraction is tested on a 1.8 mm slotted sieve and material in the pass 2.36 mm to 1.18 mm fraction is tested on a 1.0 mm slotted sieve. The equipment is inexpensive and the test is easily done and fast.

High amounts of flakey particles in a fine aggregate may warn of difficulty in compacting asphalt mixtures in which the material is used by itself as the fine aggregate. Caution should be exercised with fine aggregates that contain amounts of flakey particles (as defined by the test method) in excess of 30% in the 1.18 mm fraction and in excess of 25% in the 2.36 mm fraction. This only applies when such aggregates are the sole fine aggregate in the mixture.

The measurement of flakey particles may also be used to compare the effect of different crushers and crusher systems on creation of flakey particles in fine aggregate. It may also be used to identify and compare suitable concrete making sands.

Keywords: aggregate, concrete, crusher screenings, flakey particles, grading, hot mix asphalt, manufactured sand, particle shape, sand, slotted sieves, testing,

A FLAKINESS TEST FOR FINE AGGREGATE

Chris Rogers and Bob Gorman
Ministry of Transportation Ontario,
Canada





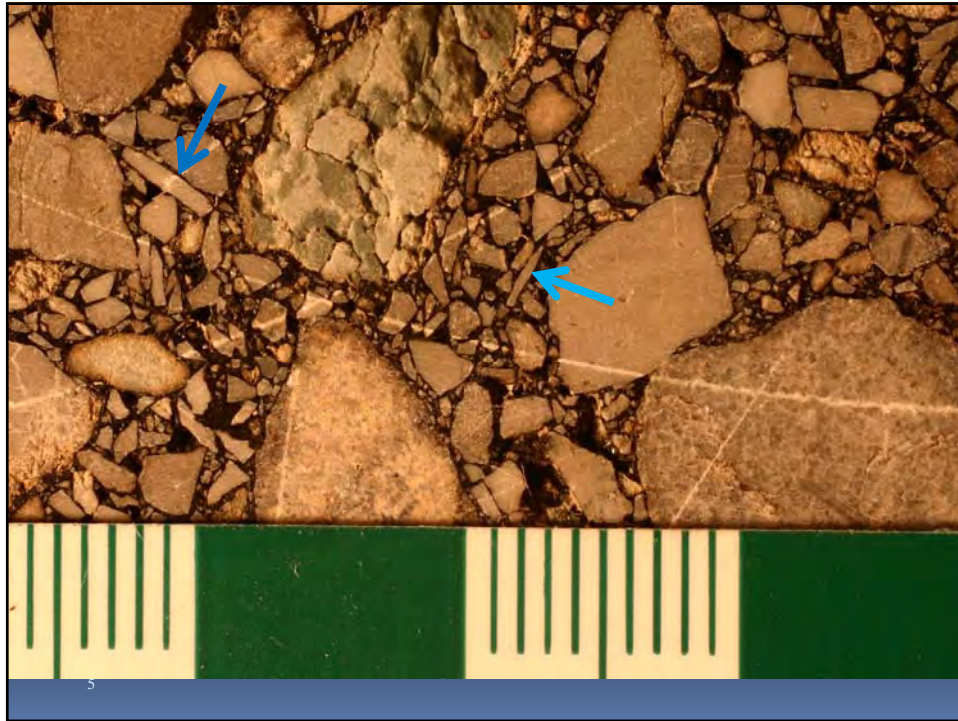

Un-compactable Mixture

- Mixture with quarried stone and manufactured sand – Marshall design
- Would not compact (92% target) in field
- Changed rolling pattern, rollers, pavers, temperature, AC, stone % and stone source – did not improve
- Changed manufactured sand to that from another quarry – success!
- Original sand was very flakey – poor shape
- New sand less flakey

Tests for Angularity of Fine Aggregate

- Direct methods
- Visual
- Army Corps of Eng. (microscope)
- Laughlin method (enlarged photos)
- Image analysis - digital
- Indirect methods
- Packing density - mass (NAA, ASTM C1252)
- Time (French egg timer)
- Direct Shear (shear box, CAR, Florida Bearing Ratio)

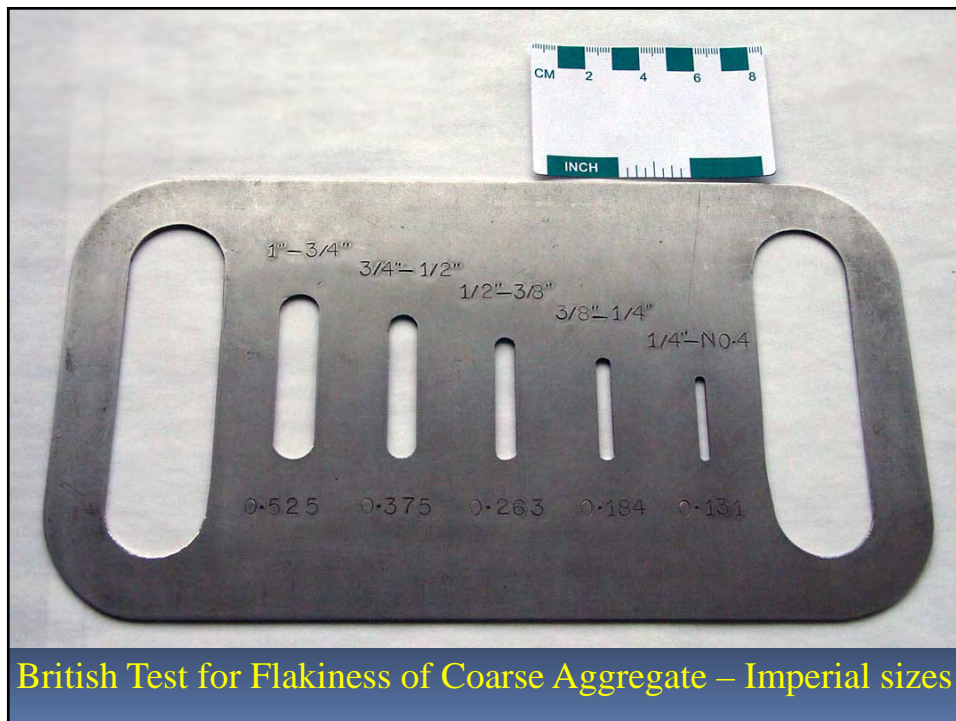



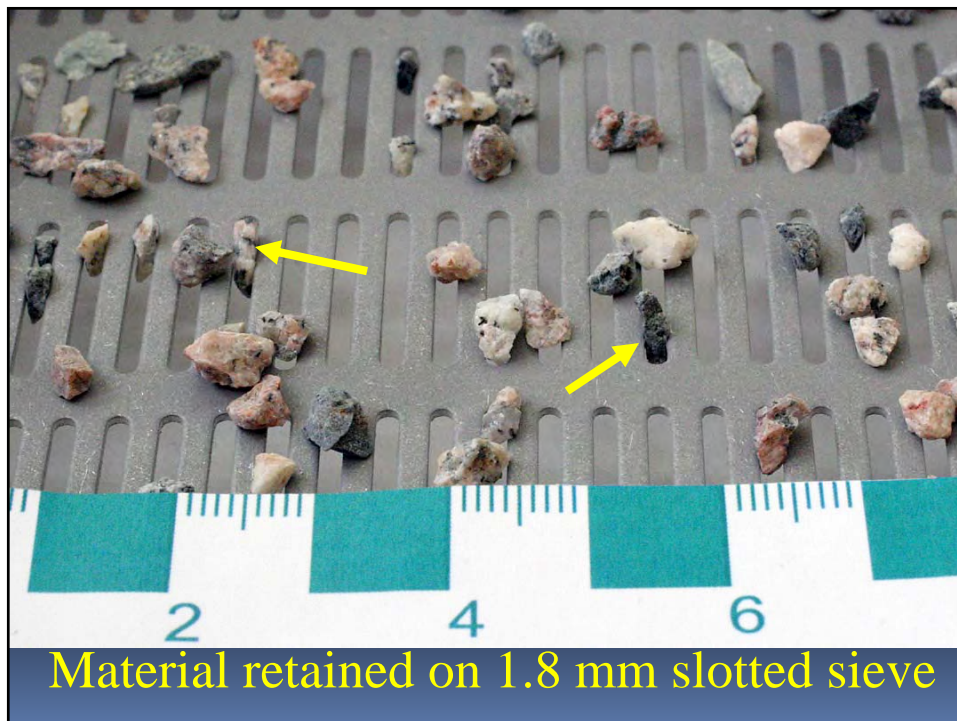
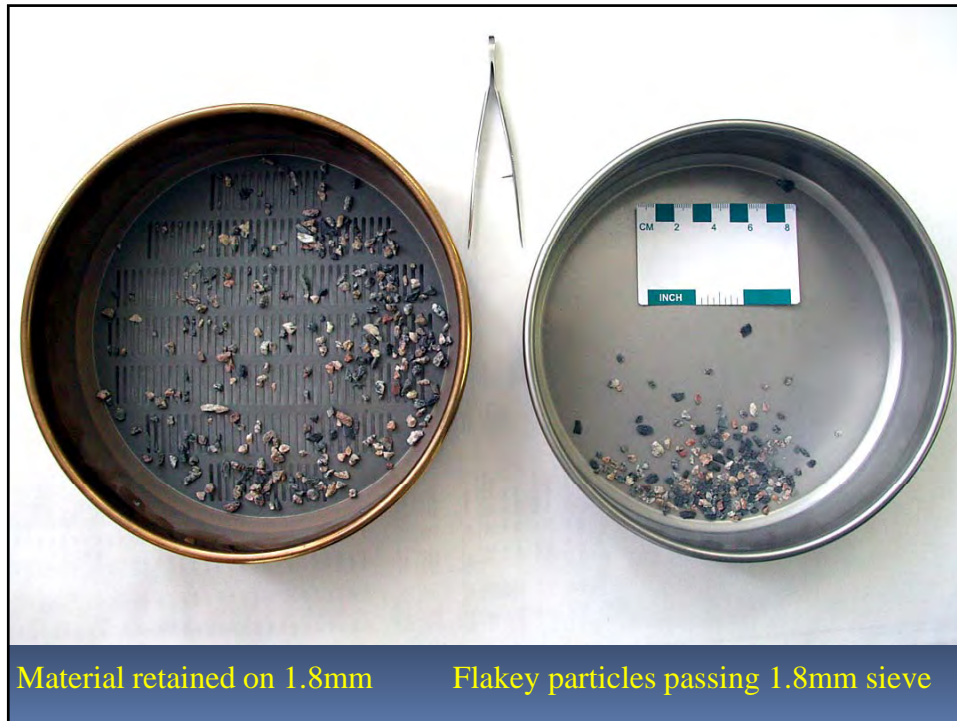

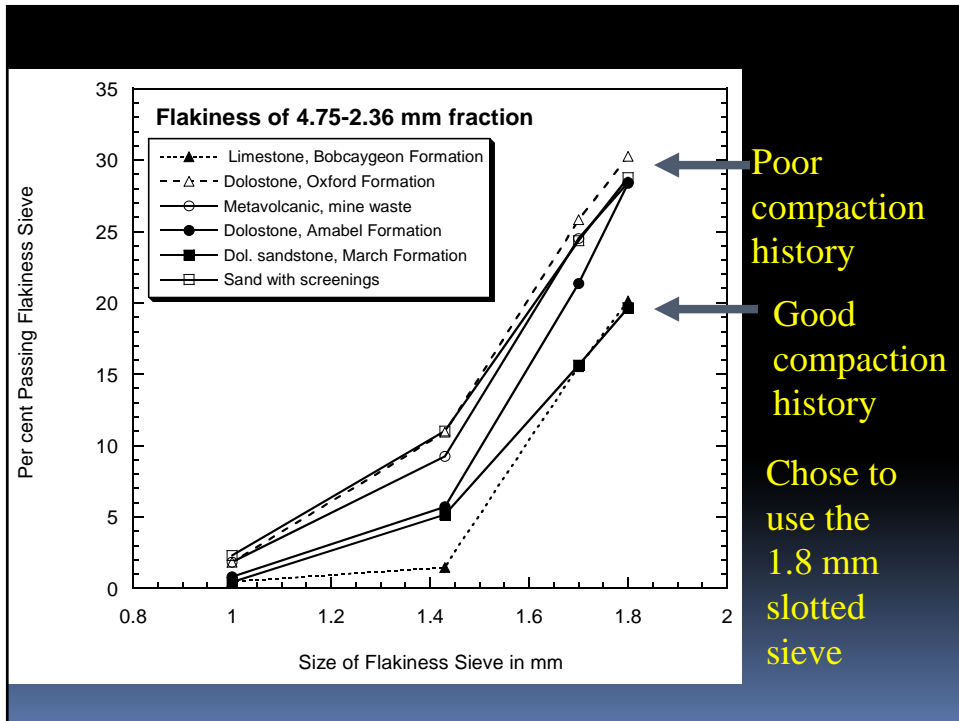

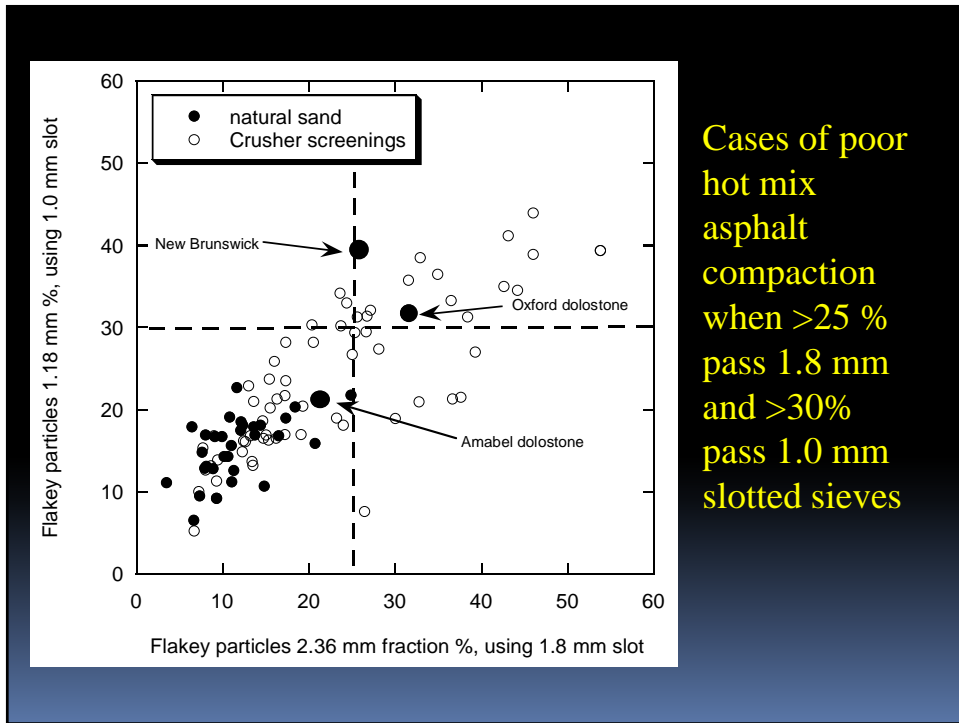
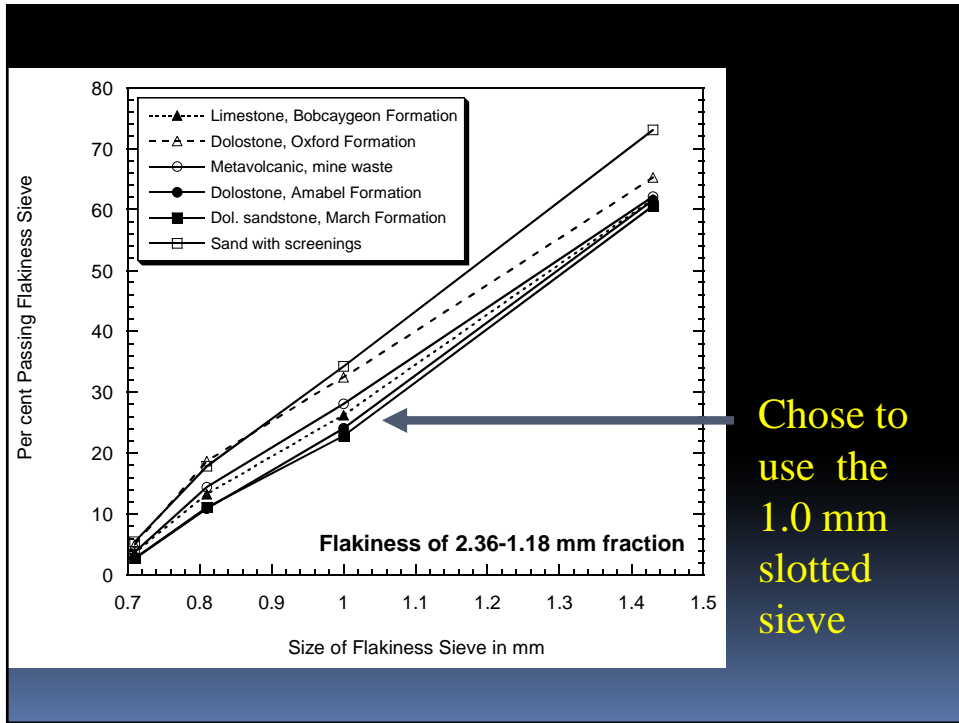

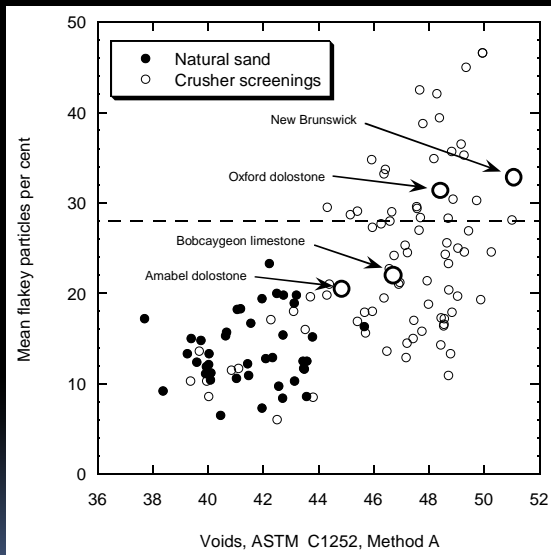

Possible boundary for un-compactable manufactured sands
Mean = 28 %

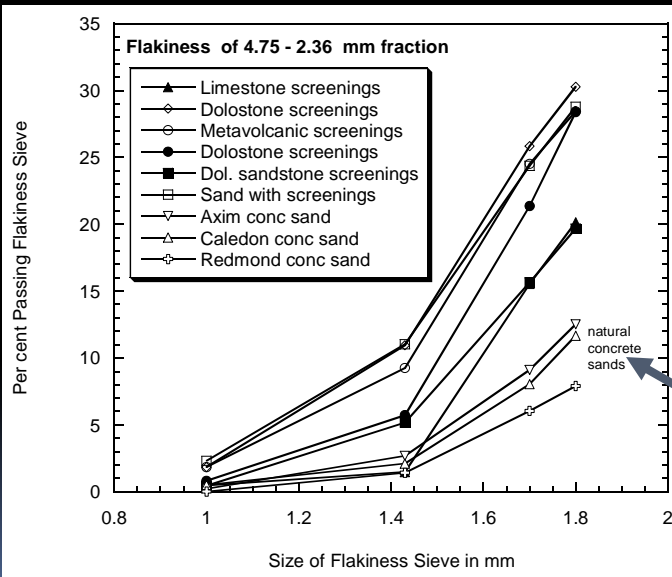

Can we use this for other sands?

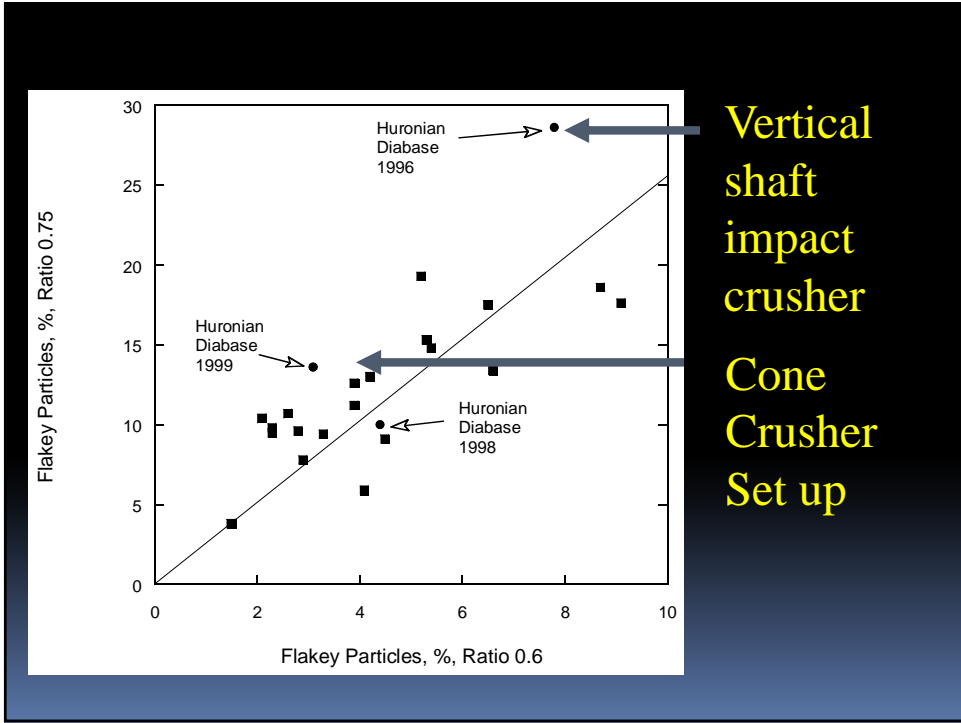

Vertical shaft impact crusher
Cone Crusher Set up

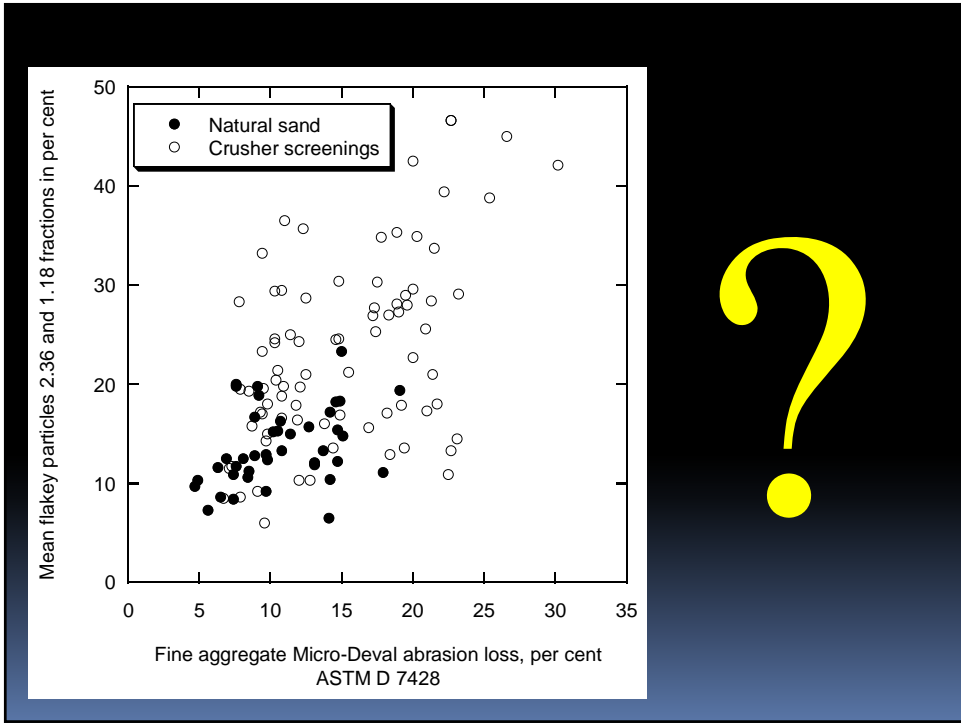

Conclusions

- The measurement of flakey particles is simple and inexpensive. The slotted sieves are commercially available.
- High amounts of flakey particles warn of possible difficulty in compacting asphalt >30% in the 1.18 mm fraction and >25% in the 2.36 mm fraction or mean of 28%.
- Un-compacted Voids (ASTM C1252, Method A) >45 may have high or low amounts of flakey particles. Does not warn of compaction problem due to particle shape.
- The flakiness test may be useful for measuring the shape of sand given by different crushers or reduction ratios.

A FLAKINESS TEST FOR FINE AGGREGATE

Chris Rogers

Post Office Box 185, 161 Centre Street, Beeton, Ontario, Canada, L0G 1A0

E-mail rogers.chris@rogers.com

Bob Gorman

Soils and Aggregates Section, Materials Engineering and Research Office

Ministry of Transportation, Downsview, Ontario, Canada, M3M 1J8

E-mail bob.gorman@ontario.ca

ABSTRACT

The presence of excessive amounts of flakey particles in the coarser fractions of fine aggregate are thought to be the cause of two cases of 'Uncompactable Hot Mix Asphalt' that have occurred in Canada. This paper describes the development of a test for measuring the amount of flakey particles in fine aggregate. Commercially available slotted sieves for testing grain or seeds are used. Material in the pass 4.75 mm to 2.36 mm fraction is tested on a 1.8 mm slotted sieve and material in the pass 2.36 mm to 1.18 mm fraction is tested on a 1.0 mm slotted sieve. The equipment is inexpensive and the test is not excessively time consuming.

High amounts of flakey particles in a fine aggregate may warn of difficulty in compacting asphalt mixtures in which the material is used by itself as the fine aggregate. Caution should be exercised with fine aggregates that contain amounts of flakey particles (as defined by the test method) in excess of 30% in the 1.18 mm fraction and in excess of 25% in the 2.36 mm fraction. This only applies when such aggregates are the sole fine aggregate in the mixture.

The measurement of flakey particles may also be used to compare the effect of different crushers and crusher systems on creation of flakey particles in fine aggregate.

Keywords: aggregate, crusher screenings, flakey particles, grading, hot mix asphalt, manufactured sand, particle shape, sand, slotted sieves, testing,

Introduction

In 1996, a hot mix asphalt-paving contractor working near Ottawa, Ontario encountered something that he described as an “uncompactable mix”. The mix had been designed using the Marshall Mixture Design process and was what is called, in Ontario, a Heavy Duty Binder Mix. This is an asphalt base course mix made with 100% crushed aggregates, both coarse and fine. The aggregates are manufactured from quarried bedrock sources. This mixture is commonly used in Ontario and was developed to resist rutting on freeway pavements where there was very heavy truck use that would otherwise cause wheel path rutting. In this case, the contractor had designed the mixture in his own laboratory, which was well equipped and had extensive asphalt mixture design experience.

The mixture consisted of about 50% by mass coarse aggregate (> 4.75 mm) of quarried dolostone of the Oxford Formation with the fine aggregate consisting of manufactured sand from the same source. The materials met and exceeded all relevant material specifications. The experienced paving crew were unable to obtain the required compaction in the field. A variety of solutions were sought. Various combinations of paving and compaction equipment and rolling patterns were tried to no avail. Changes in layer thickness or temperature did not work. The coarse aggregate was substituted for another with no success. The ultimate solution was found to be to substitute the dolostone fine aggregate with manufactured sand from a limestone quarry. After a redesign of the mixture, paving took place with no problems and adequate compaction was achieved.

We were asked to look at the dolostone fine aggregate to see if there was any characteristic that might indicate the cause of the problem. An examination under the microscope showed that the particles retained on the 1.18 and 2.36 mm sieves contained large amounts of flakey particles. The number of flakey particles in the limestone sand was less and the particles were not so obviously flakey or sharp.

At this point, we started to look for a cheap, easy, and practical test that might be used as a tool in the normal commercial mix design laboratory to warn of, or indicate, manufactured sands that were extremely flakey and might contribute to or cause lay down or compaction problems. More recently, the focus of researchers has been on image analysis techniques (Masad *et al* 2007). The sophistication of the equipment is such that

it can rarely be justified in a commercial asphalt mixture design laboratory and is not commonly available.

Test Method Development

The first test that was looked at was the test for flat and elongated particles. In Ontario, a hand-held set of proportional callipers set in ratio of 4:1 is used. Unlike the conventional “Army Corps of Engineers” callipers used in ASTM D4791, the hand-held callipers are capable of being used to fairly easily measure proportions of particles retained on the 2.36 mm sieve. However, the quality of manufacture is such that a great deal of operator experience is needed and there are variations in the accuracy of different callipers. It was known that the coarse aggregate version of the method had extremely poor multi-laboratory variation. It was desired to devise a piece of test equipment that would be accurate, reduce the effect of operator influence, and give reproducible results in different laboratories. For this reason, this test was not pursued further.

We also examined the uncompacted voids test (ASTM C1252). This test has lower limits for acceptable asphalt paving aggregates but no upper limits. No suitable upper value could be easily identified that would not result in possible rejection of materials which might perform satisfactorily while rejecting those which gave a mixture with poor compaction characteristics.

In the United Kingdom, there is a flakiness test used on coarse aggregate (Photo 1) and special slotted sieves that are commercially available which are used to determine if particles are deemed by the test method definition to be flakey. In the British Standard (BS 812), they define the slot dimensions through which flakey particles will pass as 0.6 of the mean size between two consecutive sieves. For instance, for a sieve fraction of pass 6.3 mm and retained on 4.75 mm, the mean size is 5.53 mm. $5.53 \times 0.6 = 3.3$ mm. Coarse aggregate is first sieved to refusal on a square opening sieve of 4.75 mm and then the material retained on that sieve is re-sieved on the flakiness sieve of the appropriate slot size (3.3 mm in this case). In actual practice, manipulation or examination of each particle takes place to determine if it can be fitted through the slot. Material which passes the slot is defined as a flakey particle and the proportion of these are expressed as a per cent by mass of the original material retained on the square opening sieve. There are no

known slotted flakiness sieves for fine aggregates and, indeed, the British Standard says that this test is not applicable to material passing a 6.30 mm sieve.

We had a machine shop make slotted sieves in a variety of sizes. This was done by taking a solid billet of steel approximately 100 mm square and 30 mm deep. Using an extremely accurate computer controlled wire cutter, slots were cut in the solid steel to the required size. To create a suitable hollow to contain and hold particles, the steel billet was then milled out, leaving a thin base of about 2 mm thickness and solid steel sides. Each sieve made in this way cost about \$500. It was also not a process that would be easily amenable to mass production.

Early investigations were conducted on sieves made in this way. One of the problems that immediately became apparent was the need to obtain representative specimens from bulk samples. It was found that, after sieving by hand on the slotted sieves, there was still a need to inspect and sometimes manipulate each particle with a pair of tweezers to see if it would fit through the slot. Flakey particles lie flat on the sieve surface and do not easily present their edges to the slots. Many flakey particles will fall through during hand sieving, but not all. The consequence is that, if the sample is large, the number of particles that have to be individually examined becomes very large and the task is tedious. In an effort to reduce the burden of testing, a spinning riffler was purchased so that small representative test samples could be accurately made.

In a spinning riffler system, materials are fed from a hopper in a narrow stream onto a slow-moving vibrating feeder. The feeder discharges into identical sample containers or test tubes placed on a spinning turntable. It takes approximately 30 passes under the stream of aggregate from the feeder to fill each test tube to capacity. The number of passes depends on feeder speed, turntable speed, and desired sample size. One or more of the filled test tubes can be further subdivided using the same technique. This results in a more representative sample than could be obtained using any other technique. Spinning riffles are capable of removing the effects of segregation in a material stream by the use of multiple passes to acquire the sample. The process will work best if the turntable turns relatively quickly and the flow of material is relatively slow so as to maximize the number of passes needed to acquire a sample.

Following the British Standard definition for the fraction from 4.75 to 2.36: The mean size is 3.55 mm. $3.55 \text{ mm} \times 0.6 = 2.13 \text{ mm}$. This size seemed too pass too much material and, as a result, a variety of smaller slotted sieves were tested to understand more fully some of the relationships. A ratio of 0.75 of the retaining sieve was finally chosen, which is $2.36 \text{ mm} \times 0.75 = 1.77$ (or 1.80 mm). We also evaluated a size of 1.42 mm that was developed from $2.36 \text{ mm} \times 0.60 = 1.42 \text{ mm}$ slot size. The 1.0 mm and 1.70 mm sieves were also used because they were available. The results of testing a variety of fine aggregates are shown in Table 1. Figure 1 shows graphically how the amount of flakey particles varies as a function of slot or flakey sieve opening for material passing the 4.75 mm sieve and retained on the 2.36 mm sieve.

Table 1 also shows the same relationship for material pass the 2.36 mm sieve and sieved to refusal on a 1.18 mm sieve and then sieved over slotted sieves of various sizes. For the 2.36 to 1.18 mm fraction, the mean size is 1.77 mm. $1.77 \text{ mm} \times 0.6 = 1.06 \text{ mm}$ that is the size needed if the British definition of a 0.6 ratio of the mean opening size is used. For the same fraction, but calculating the slot size using the ratio of size of the retaining sieve of would give $1.18 \times 0.6 = 0.71 \text{ mm}$. If the same rationale as used for the 2.36 mm fraction were used for the 1.18 mm fraction, a flakiness sieve of $1.18 \times 0.75 = 0.89 \text{ mm}$ would be needed. In Figure 2, a graph of flakey particles as a function of slot opening is shown for the 1.18 mm fraction. A flakiness sieve (1.42 mm) developed for testing the 2.36 mm fraction was also used since it was available. As was expected, very large amounts of material passed this sieve and the majority could not properly be defined as flakey particles since they were often smaller non-flakey, or roughly equidimensional, particles found in the sieve fraction.

In both graphs, it is noteworthy that there is an apparent straight-line relationship between size of the slot and amount passing. The exception is in Figure 1 for the 1 mm slot for the retained 2.36 mm fraction where very few particles passed the slot.

After this development work was carried out, we became aware that slotted sieves used for testing seeds and grain were commercially available at a reasonable cost (Photo 2). These were made from punched plate and were available from 1 mm upwards in 0.1 mm increments. A decision was made at this point to arbitrarily focus on one slot size for each fraction. For the 2.36 mm fraction, the 1.80 mm size was chosen (Photos 3 and

4) and for the 1.18 fraction the 1.00 mm slot size sieve was chosen. When the 1.80 mm size is chosen, it is a ratio of 0.75 of the retaining sieve (2.36 mm). A similar sieve would have been chosen for the 1.18 mm fraction that is 0.89 mm. However, the lack of commercial availability of that size swayed the decision to use the smallest commercially available slotted sieve of 1.0 mm. It is realized that this choice was arbitrary, but the search was for a practical and low cost test that would warn asphalt mix designers of potential problems.

Figure 3 shows the relationship with the percent flakey particles in the 2.36 mm fraction with the per cent flakey particles when the 1.0 mm and 0.89 mm slotted sieves are used for testing the 1.18 mm fraction. Significantly, there is a better correlation with flakey particles in the 2.36 mm fraction (using the 1.8 mm slot) when the 1.0 mm slotted sieve is used, further justifying the choice of the commercially available 1.0 mm slotted sieve for that fraction rather than the 0.89 mm sieve.

Sample Collection

We collected about 120 samples of aggregates used in concrete and asphalt from across Ontario. This included natural glacio-fluvial sands composed substantially of rounded and sub-angular particles; mixtures of natural sands and crusher screenings, and samples composed exclusively of crusher screenings or manufactured sands. Most of these had a history of being used in either asphalt or concrete or both. The composition of the fine aggregates varied from those composed of 100% siliceous rock types from the central and northern parts of the province, to those of 100% carbonate rock from the south, as well as of mixtures of both carbonate and siliceous rock types in natural sands. The sample collection was broad enough that samples of most of the fine aggregates likely to be encountered in Ontario were represented. A variety of crusher types and crushing set ups were also represented.

Testing Program

The sands were tested in a variety of tests:

1. The fine aggregate micro-Deval test now published by ASTM as D7428 – 08,
2. Bulk density and water absorption following ASTM C128,

3. Aggregate uncompacted voids using method A and B following ASTM C1252,
4. Flakey particles (in per cent) using the test described in this paper and described in detail in Appendix 1.
5. Compacted Aggregate Resistance Test (CAR) following the proposal of D. Jahn following a simplified method (2004) described in Appendix 2.

Results and Discussion

Figure 4 shows a plot of flakey particles in the 1.18 mm fraction compared with flakey particles in the 2.36 mm fraction. As might be expected, fine aggregates that have a lot of flakey particles in one fraction tend to have a lot in the other fraction. However, regression coefficients are not strong and have been omitted from this plot for clarity. As might be expected, natural sands tend to have a lot less flakey particles than crusher screenings. There are some crusher screenings that plot in the field of the natural sands and is suspected that these may be mixtures of natural sand and crusher screenings. Further microscopic study is needed. It is noteworthy that no natural sands have large numbers of flakey particles ($> 25\%$). Also plotted on this graph is the screenings sample labelled as 'Oxford dolostone', which first raised the issue of uncompactable mixtures. It can be seen that this material contained over 30% flakey particles in both sieve fractions. Also plotted is a material labelled as 'Amabel dolostone'. This material is of Silurian age from the Niagara Escarpment and is a high purity reefal dolostone. This material has a long history of use in 'Heavy Duty Binder Mixes', where 100% crushed coarse and fine aggregate is used in asphalt base course. This material had flakey particles of about 20% in both fractions and has given good performance. In about 2002, we became aware of another case of a suspected uncompactable mix. This occurred in the province of New Brunswick, and some of the physical characteristics of the rhyolitic fine aggregate are summarized in Table 2, together with those for the Amabel dolostone. This data is shown graphically in Figure 4. It is noteworthy that this material had a very high amount of flakey particles and reportedly gave problems with compaction similar to those described in the introduction that occurred in Ontario.

Tentative limits are drawn on the graph of 30% for the 1.18 mm fraction and 25% for the 2.36 mm fraction. We speculate that, when crusher screenings are found with

values in excess of both of these values AND the materials are used by themselves in a 100% crushed aggregate asphalt mixture, there is an increased likelihood that compaction issues may arise. This warning does not necessarily apply if the crusher screenings/manufactured sand is blended with either natural rounded sand or manufactured sand with a low amount of flakey particles.

To obtain further information about this issue and the possible limits that may act as a warning, further experiences with uncompactable or hard to compact mixtures will have to be gained. These are apparently rare and the likely cause may be overlooked.

Figure 5 shows a plot similar to that of Figure 1 but, in this case, three concrete sands have been plotted. Two of these sands (Caledon and Redmond) have a long history of extensive satisfactory use in hydraulic cement concrete. It is noteworthy, but not unexpected, that they have low amounts of flakey particles compared to the crusher screenings/manufactured sands. If they did have a very flakey nature, the negative effect on water demand would probably be such that they would not be economically used in their respective market areas. The third sand 'Axim' is a standard concrete sand used by a chemical supply company for testing admixtures.

Figure 6 shows the mean amount of flakey particles (50% of each fraction used in the calculation) plotted against the Uncompacted Voids Content of ASTM C1252, Method A. Generally, using the Superpave mixture design process, it is desirable to use fine aggregates that have a voids content of greater than 45 or 43 (in some cases) for high ESAL asphalt pavements. It can be seen that, generally, natural sands gave values less than about 44 and the crusher screenings/manufactured sands values in excess of this. It is notable that there is not a strong relationship between voids value and amount of flakey particles. Crusher screenings with voids value in the 48 range can have flakey particle contents that range from about 11% to 40%. If the voids value predicts stability of asphalt mixtures, it certainly will not warn of the presence of high amounts of flakey particles. The two tests are measuring different properties and both should be considered when evaluating a crusher screenings for use in asphaltic concrete.

The Uncompacted Voids Content test was originally developed by the National Crushed Stone Association (Gray and Bell, 1964) for predicting finishability of concrete sand. As there is increasing use of manufactured sands in this application, it may well be

useful to also look at the amount of flakey particles present in the manufactured sand as Figure 6 clearly shows that Voids by itself does not reliably predict flakey particle content.

With more equidimensional (less flakey) aggregate, the optimum asphalt content will normally be reduced due to a better packing density and lower internal surface area. Therefore, it would be useful to measure the amount of flakey particles of crusher screenings to choose those sources of supply that contain the least amount, other things being equal. This would be beneficial when high amounts of crusher screenings or manufactured sands are being used in an asphalt mixture.

Figure 7 shows the results of testing three samples of crusher screenings from the same quarry over four years. The material was a hard diabase of Precambrian age (Huronian). In 1996, the quarry operators were using a different crusher than was used in 1998 and 1999. The production of crusher screenings from 1996 had significantly more flakey particles than that produced with the different crushers in 1998 and 1999. The crusher used in 1996 was a vertical shaft impact crusher that had been brought in to improve shape of the coarse aggregate. The crushers used in later years were a more conventional series of cone crushers. The flakiness test may be useful for evaluating shape of fine aggregate produced by different types of crusher and by different reduction ratios. Further study is needed.

Figures 8 and 9 show relationships of water absorption and flakey particles as a function of fine aggregate Micro-Deval loss. No obvious relationships can be observed which is not unexpected. However, flakiness of fine aggregate from a single aggregate source may influence Micro-Deval loss. For instance, flakey particles may be more easily abraded in the rotating drum than cubical particles from the same source.

Figure 10 shows the relationship between flakey particles and the Compacted Aggregate Resistance test (Jahn, 2004). The CAR test is done by measuring the resistance to embedment of a metal cylinder on aggregate compacted in a Marshall mold normally used for asphalt mixture design purposes (see Appendix 2). The values obtained are thought to be related to shear resistance of the compacted sand. Low CAR values indicate relatively low shear resistance; high values indicate relatively high shear resistance. This figure shows that shear resistance is apparently unrelated to the amount

of flakey particles. Other properties such as surface texture and roundness must be more important. As expected, the natural sands that generally have a rounded and polished texture all gave relatively low CAR stability (lower shear strength). Conversely, not all crusher screenings gave high CAR values.

Figure 11 shows the relationship between Uncompacted Voids and the CAR test values. It is noteworthy that there were no sands or screenings with low Voids values (< 45) that gave high CAR values. Whether or not the CAR test can be used in place of Uncompacted Voids Test as suggested by Jahn (2004) is unknown, but there does appear to be a relationship between the two different tests.

Conclusions

The measurement of the amount of flakey particles in the coarse fractions of fine aggregate is simple and inexpensive. The slotted sieves necessary to do this are commercially available.

High amounts of flakey particles in a fine aggregate may warn of difficulty in compacting asphalt mixtures in which the material is used by itself as the fine aggregate. Two known cases of such mixes have been briefly documented and the responsible fine aggregates had amounts of flakey particles (as defined by the test method) in excess of 30% in the 1.18 mm fraction and in excess of 25% in the 2.36 mm fraction.

Materials that have Uncompacted Voids (ASTM C1252, Method A) contents in excess of 45 may have either high or low amounts of flakey particles. Thus, the ASTM test does necessarily warn of a potential compaction problem due to particle shape.

The flakiness test may be useful for comparing the shape of crusher screenings produced using different crusher types or using different reduction ratios.

The Compacted Aggregate Resistance Test is not related to the proportion of flakey particles in a fine aggregate, and cannot be used to predict problems caused by the presence of excessive amounts of flakey particles.

There is a relationship between the ASTM Uncompacted Voids value and the CAR test.

Further Development Needed

There is a need to gain experience with this test in a variety of laboratories and applications. It is thought that this test would never be suitable in a material specification. It might be used by people selecting sources of material, as a screening test, to indicate potential problems related to excessive amounts of flakey particles. It can also be used to compare the effect of different crushers and crusher systems on generation of flakey particles in fine aggregate. The authors welcome feedback on the utility of the test.

ACKNOWLEDGEMENTS

We wish to acknowledge the assistance of Bert Hendricks of Tomlinson Construction of Ottawa, Ontario, who first investigated the problem with an uncompactable asphalt mix and recognized the probable contribution of the flakiness of the manufactured sand to his problem. Mike MacKay, of JEGEL in Toronto, gave information on the case in New Brunswick. Everton Arnold and Mark Vasavithasan provided help with issues associated with conducting and interpreting the results from the CAR test. Steve Senior took the photographs. We also wish to acknowledge the hard work of the staff of the Soils and Aggregates Section of the Ministry of Transportation who conducted the testing and other staff of the Ministry Aggregate Units who collected the samples throughout Ontario.

REFERENCES

1. Masad, E., T. Al-Rousan, J. Button, D. Little, E Tutumluer, *Test Methods for Characterizing Aggregate Shape, Texture and Angularity*, NCHRP Report 555, Transportation Research Board, Washington, D.C., 94p., 2007.
2. British Standard 812, *Flakiness Index*, British Standards Institution, London, UK, Section 105.1, 4p., 1985.
3. Gray, J.E., and Bell, J.E., *Stone Sand*, Engineering Bulletin No. 13, National Crushed Stone Association, 1964.
4. Jahn, D., *The Compacted Aggregate Resistance Test: Replacement for FAA?*, International Center for Aggregates Research, Annual Symposium, University of Texas, Austin, Texas, 2004.

Table 1. Data demonstrating how per cent flakey particles in fine aggregate varies as a function of slot size used to define flakey particles

Sample description	Slot opening of flakiness sieve for testing 4.75-2.36 mm fraction	Per cent passing the slotted sieve	Slot opening of flakiness sieve for testing 2.36-1.18 mm fraction	Per cent passing the slotted sieve
Limestone, Bobcaygeon Formation quarry source Satisfactory performance	1.80	20.14	1.43	61.64
	1.70	15.52	1.00	26.27
	1.42	1.46	0.81	13.26
	1.00	0.47	0.71	3.64
Dolostone, Oxford Formation quarry source Uncompactible	1.80	30.27	1.43	65.26
	1.70	25.82	1.00	32.43
	1.42	10.95	0.81	18.72
	1.00	1.85	0.71	5.02
Metavolcanic, mine waste quarry source Satisfactory performance	1.80	28.43	1.43	62.11
	1.70	24.50	1.00	28.11
	1.42	9.24	0.81	14.43
	1.00	1.84	0.71	3.76
Dolostone Amabel Formation quarry source Satisfactory performance	1.80	28.39	1.43	61.51
	1.70	21.35	1.00	24.06
	1.42	5.70	0.81	10.92
	1.00	0.80	0.71	2.73
Dolomitic sandstone March Form ⁿ quarry Satisfactory performance	1.80	19.65	1.43	60.60
	1.70	15.64	1.00	22.83
	1.42	5.16	0.81	11.12
	1.00	0.44	0.71	2.78
Sand with crusher screenings No history of use	1.80	28.78	1.43	73.07
	1.70	24.36	1.00	34.24
	1.42	11.02	0.81	17.85
	1.00	2.29	0.71	5.43

Table 2 - Properties of fine Aggregates of effect of particle shape on compaction properties and stability of asphalt. Tested by MTO laboratory January 2002.

	New Brunswick screenings, poor compactability	Amabel dolostone, high stability manufactured sand, satisfactory performance
ASTM C1252 Method A	51.1	44.5
ASTM C1252 Method B for 1.18 mm	53.5	49.6
for 600 µm	56.0	51.1
or 300 µm	55.9	51.3
ASTM Method B, Mean	55.1	50.7
Flakey particles, %		
4.75-2.36 mm on 1.80 mm	25.4	22.0
2.36-1.18 mm on 1.00 mm	41.0	20.7

Photo 1 – British Standard 812 flakiness sieve for older Imperial sieves.

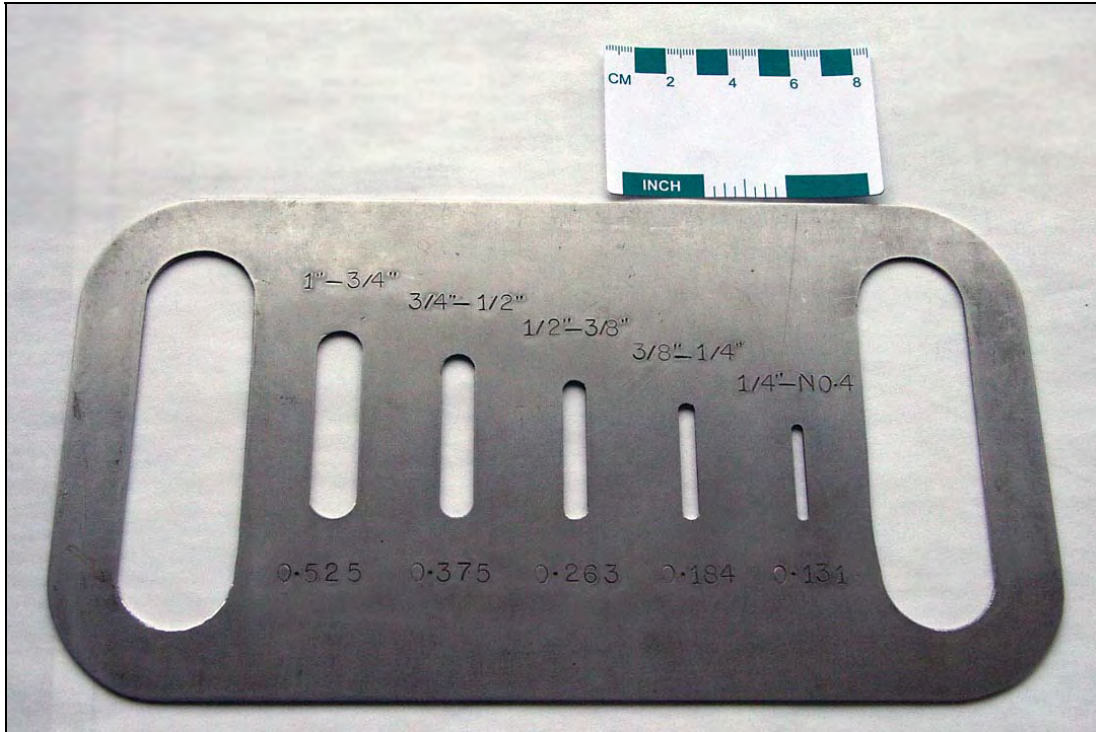

Photo 2 – Slotted sieves used in the testing described in this paper.

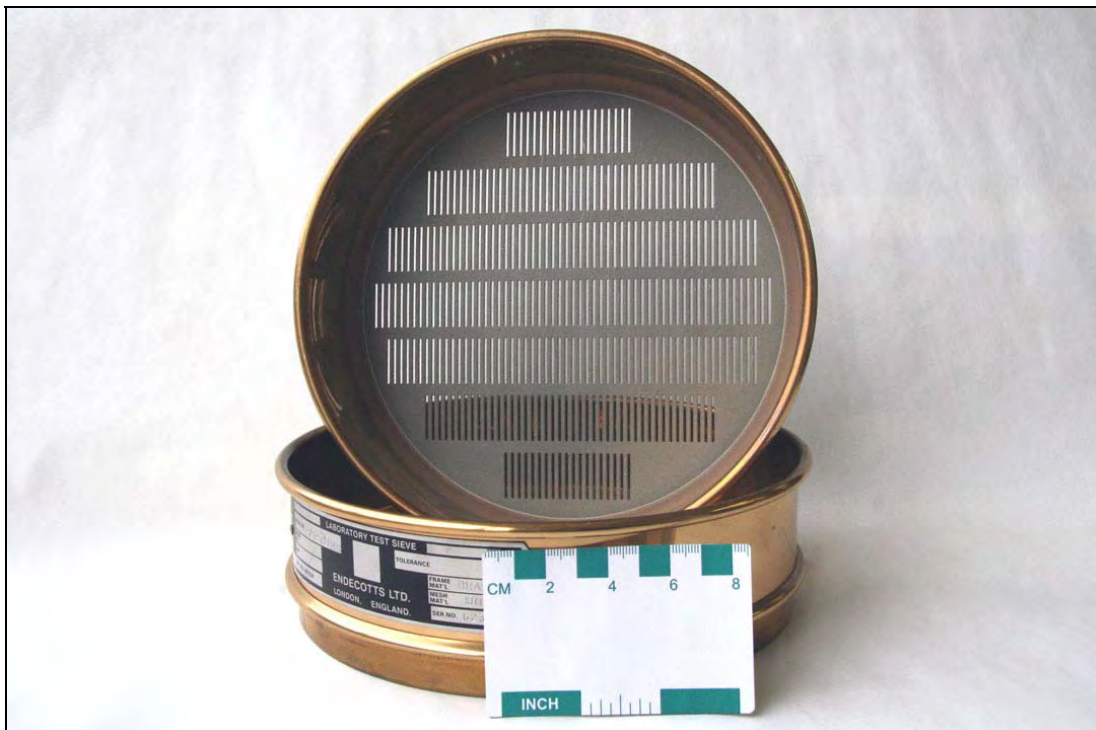

Photo 3 – Aggregate particles retained on the 1.80 mm slotted sieve (Scale in cm).



Photo 4 – Flaky particles that passed through the 1.80 mm slots (Scale in cm).



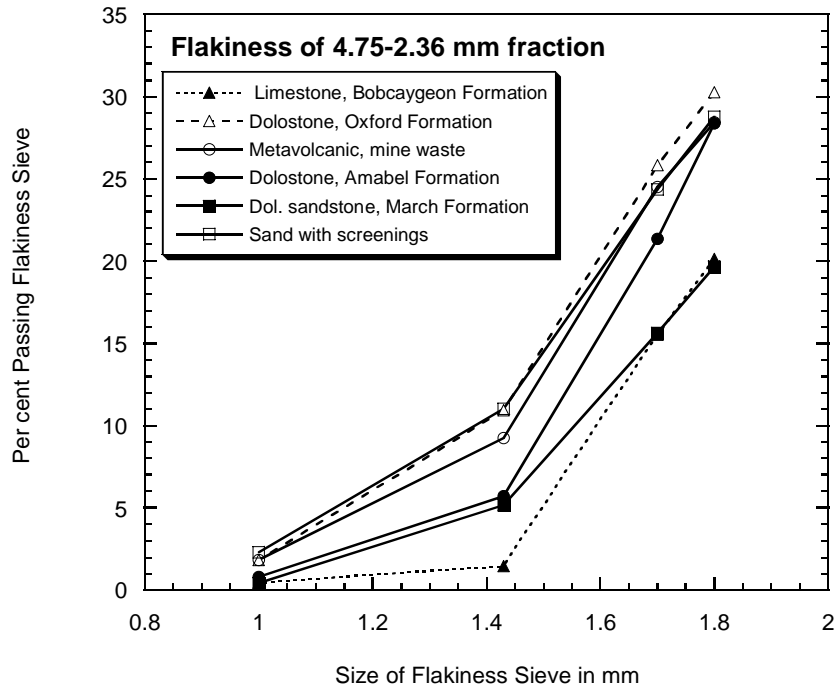

Figure 1. Variation of flakey particles with size of slotted sieve for the 2.36 mm fraction.

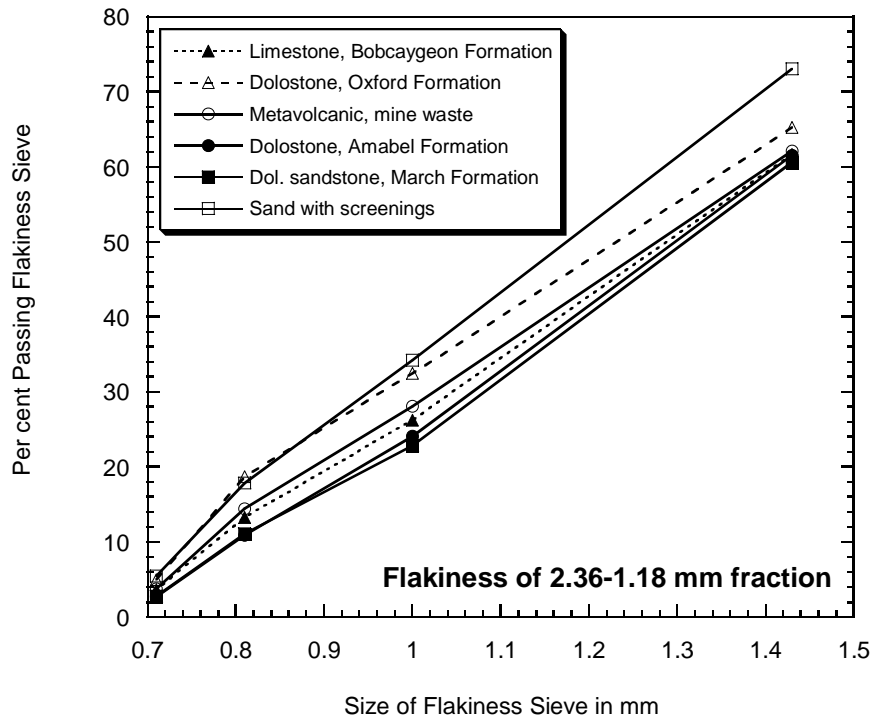

Figure 2. Variation of flakey particles with size of slotted sieve for the 1.18 mm fraction.

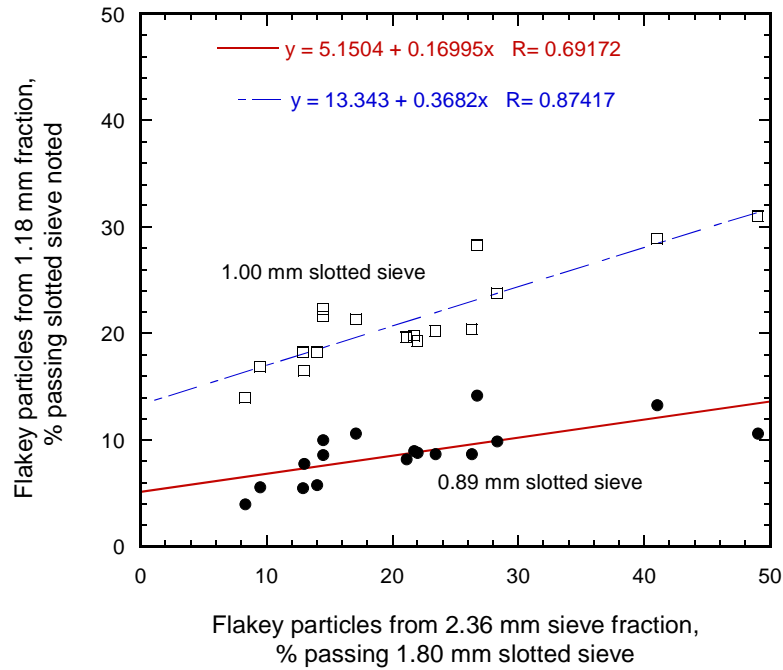

Figure 3. Correlation between flakey particles of 1.18 mm size on various slotted sieves and flakey particles of 2.36 mm size using a 1.80 mm slotted sieve.

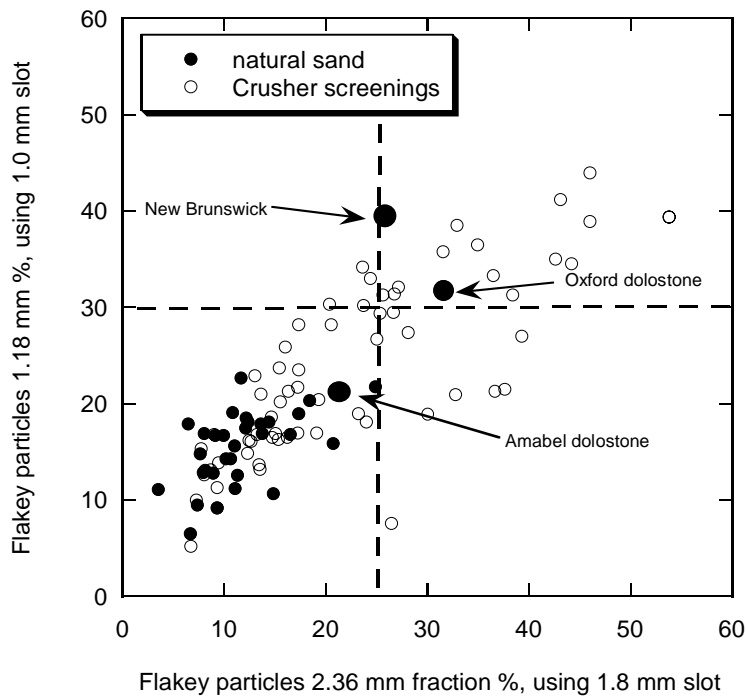

Figure 4. Comparison between flakey particles of 1.18 fraction with 2.36 mm fraction.

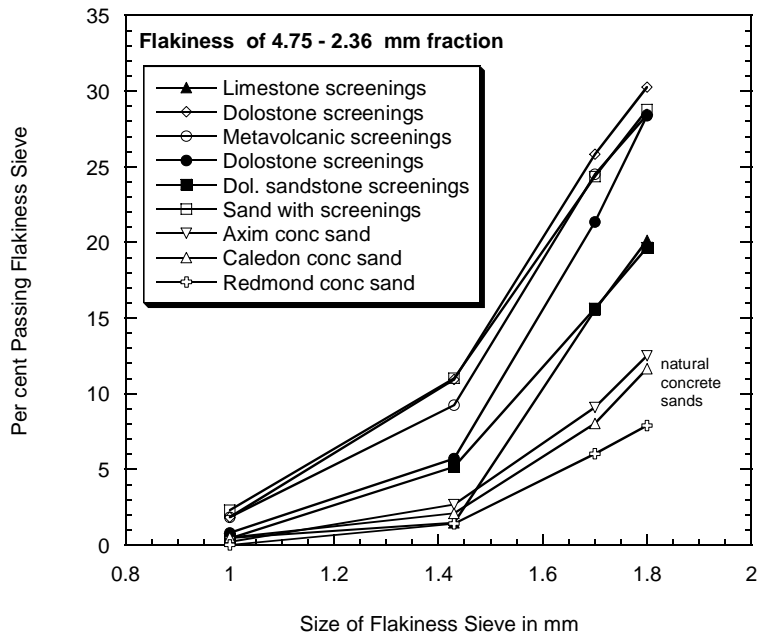

Figure 5. Comparison of flakey particles in sand and crusher screenings.

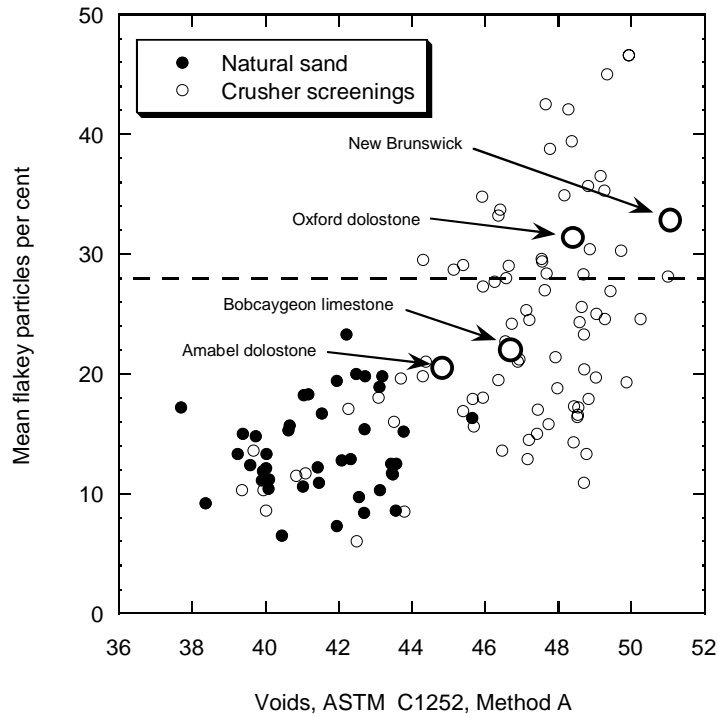

Figure 6. Mean flakey particles compared to uncompacted voids.

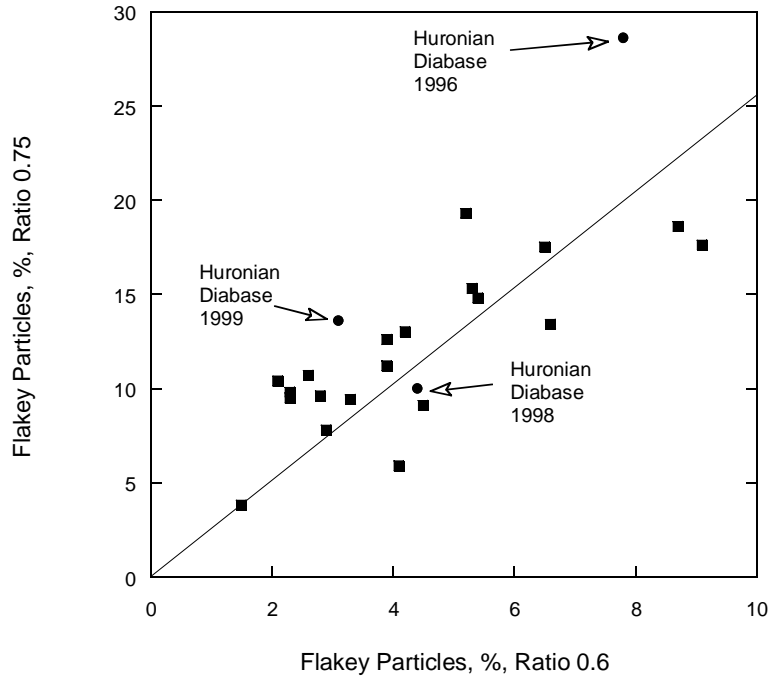

Figure 7. Flakey particles measured at various ratios of the mean sieve size, showing how materials from a quarry vary in amount of flakey particles with different crushers.

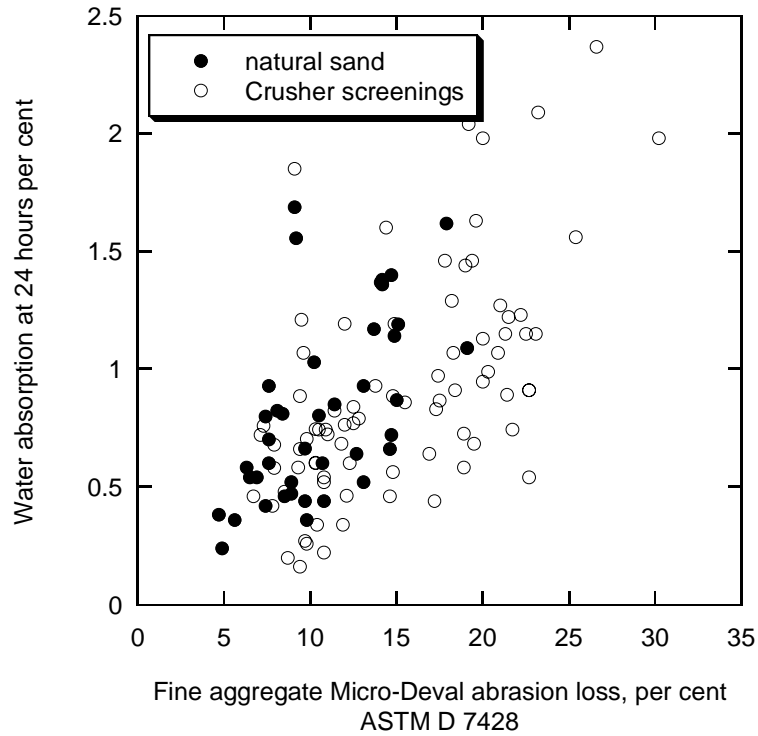

Figure 8. Water absorption compared to micro-Deval abrasion loss.

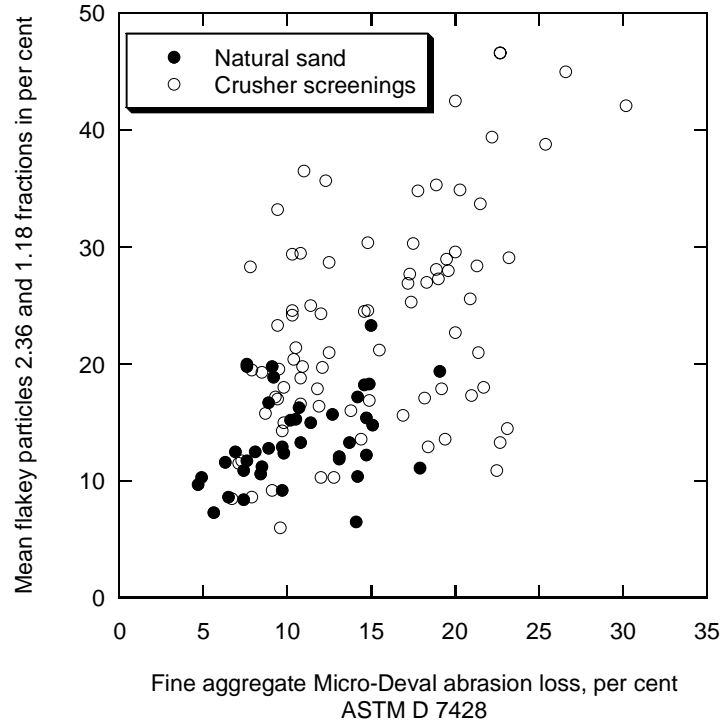

Figure 9. Mean flakey particles compared to Micro-Deval abrasion loss.

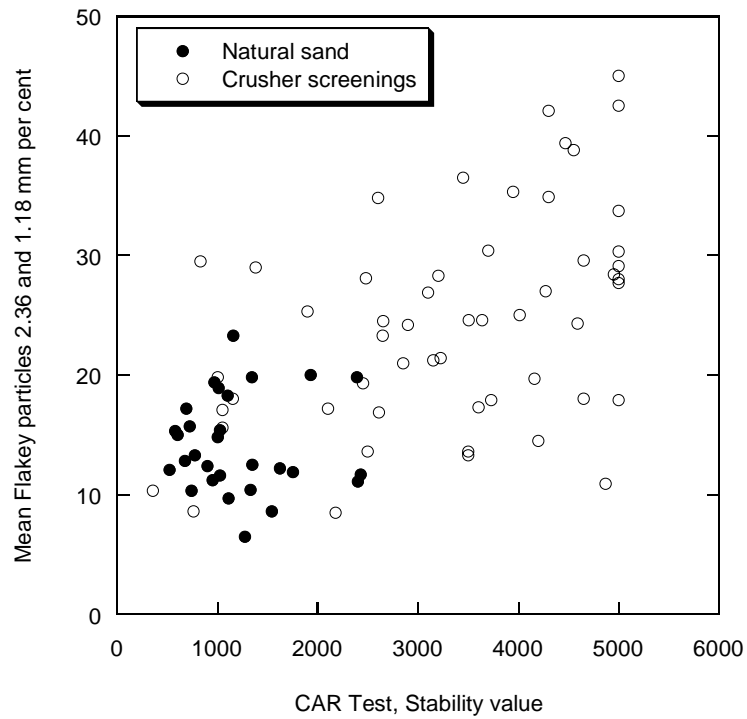

Figure 10. Mean flakey particles compared with CAR stability test value.

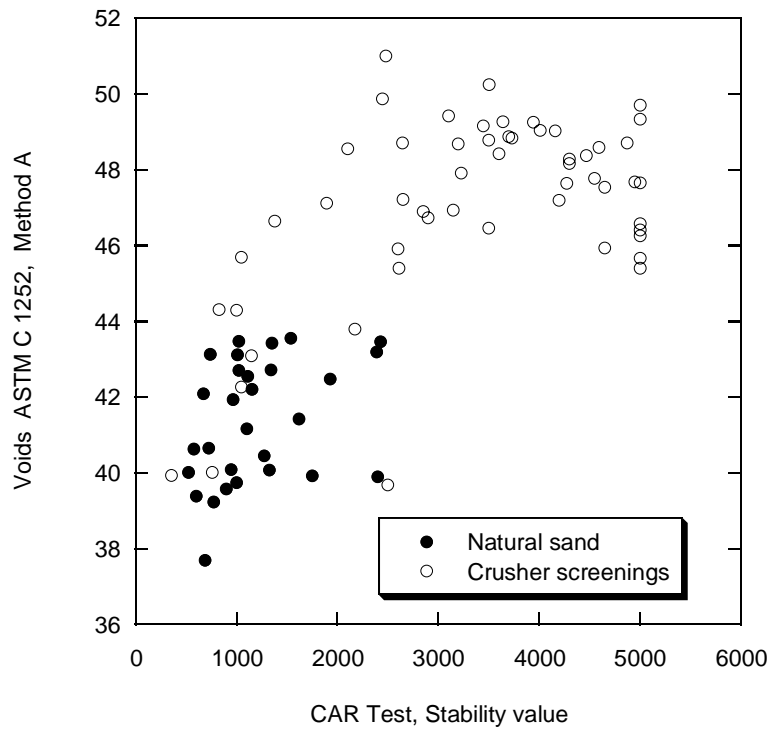

Figure 11. Uncompacted voids compared with CAR stability test value.

Appendix 1

Method of Test for Determining Amount of Flakey Particles in Fine Aggregate

Definition:

Flakey particles for the purposes of this test are fine aggregate particles that have a thickness (least dimension) which is equal to or less than 1.8 mm for material passing a 4.75 mm sieve and retained on 2.36 mm, and 1.0 mm for material passing a 2.36 mm sieve and retained on 1.18 mm sieve.

Significance and Use:

The amount of flakey particles can provide an indication of the ability of the fine aggregate to contribute to ease of compaction in dense graded hot mix asphalt pavements. A large number of flakey particles (> 25%) may indicate a fine aggregate that may result in mixtures that are hard to compact or resist compaction. Sand that is low in flakey particles may indicate a material that will contribute to a lower water demand in hydraulic cement concrete compared to sand with higher amounts of flakey particles. The amount of flakey particles in a fine aggregate may vary depending on the type of crusher used and the reduction ratio.

Equipment:

Flakiness sieves (Note 1) with a slot that is 1.80 mm for the 4.75 to 2.36 mm fraction and 1.0 mm for the 2.36 to 1.18 mm fraction. The sieves shall have a close fitting cover and pan to prevent loss of material.

Note 1: Slotted sieves for testing seeds are available from Endicott's.

Balance of adequate capacity reading to 0.01g.

Tweezers: These will be found useful for manipulation of the samples following sieving.

Suitable equipment for preparing a test sample by either cone and quartering, or the use of a spinning riffler.

Sample:

The required test sample size is as follows: 4.75 - 2.36 mm, minimum 30 g, 2.36 - 1.18 mm, minimum 10 g.

Sample Preparation:

Prepare approximately 50g of each fraction by sieving washed dry fine aggregate to refusal on the respective woven wire square opening sieve. Prepare by cone and quartering a representative test sample meeting the requirements above. Weigh to 0.01g and record (Mass A).

Note 2. It is important to avoid segregation of the sample following sieving but prior to preparing the flakiness test specimen. Splitting, in particular, may not be a good technique because sliding of the particles on a flat surface will cause flakey particles to be retarded in motion compared with the more cubical particles. The ideal technique is to use a small spinning riffler to prepare a representative sample.

Place the sample on the slotted sieve and sieve by hand, using taps with the heel of the open hand on the side of the sieve nested with the lid and pan. After sufficient sieving, so that the majority of flakey particles pass through the slot, inspect the individual particles retained on the slotted sieve to ensure all flakey particles have passed through the sieve (Note 4). When all particles have been individually examined, weigh and record the mass of material that is retained on the flakiness sieve (Mass B).

Note 3. Tweezers will be found useful.

Calculation and Reporting:

Calculate the per cent flakey particles for each fraction as follows: $A-B/A \times 100 =$ flakey particles in %.

Report the per cent flakey particles of each sieve fraction to 0.1% and the average of the 2.36 and 1.18 mm fractions in each sample to 0.1%, assuming a 50% contribution by each Note 4.

Note 4. A weighted average may be calculated based on the grading of the fine aggregate but suggested limits to separate various performance categories have not been developed.

Figure A1: Reporting form for fine aggregate flakiness test

Laboratory sample number	Sieve fraction 4.75 - 2.36 mm Original mass of sample 'A'	Sieve fraction 2.36 - 1.18 mm Original mass of sample 'A'	Mass of material retained on slotted sieve 'B'	Flakey particles A-B/A x 100 per cent

Note: Use 1.8 mm slotted sieve for 4.75 - 2.36 mm fraction and 1.0 mm slotted sieve for 2.36 - 1.18 mm fraction.

Date _____ Technician _____

Remarks

Appendix 2

Abbreviated Test Procedure for the Compacted Aggregate Resistance (CAR) Test (2003)

The CAR test evaluates the shear resistance of the blend of fine aggregate materials for HMA, using as received gradations. Useful information can also be obtained by testing individual components.

1. Mixture preparation:

1.1 Oven dry each fine aggregate material, allow to cool to room temperature, and separate into #4 x #8 and #8 x 0 components.

1.2 Combine components of each fine aggregate material, based on the intended combination of fine aggregates, sufficient to produce a compacted specimen 2.5 in. high in a 4-inch Marshall mold (approx. 1000 g).

1.3 Mix the dry materials in a mixing bowl, crater the mixture, and then add 3.5% moisture. Immediately mix until particles are uniformly coated (about 30 seconds).

2. Mixture Compaction:

2.1 Place entire coated mixture in a room temperature 4" Marshall mold with base plate and collar. Spade 20 times over the mixture with a spatula, trowel, or spoon. Round off the top of the mixture with a spatula, and place *two* pieces of non-absorbent paper cut to fit on top of the mix.

2.2 Place the mold onto the compaction hammer pedestal, and insert the compaction hammer. Seat the compaction foot on top of the loose mix by raising the sliding weight approximately ½-inch and tap the compaction foot three times.

2.3 Compact the sample using 50 blows, *one side only*, with a Marshall hammer. An automatic hammer has been used to develop this procedure.

3. Shear Resistance Determination:

3.1 Remove the collar, but leave the base plate underneath the compacted sample. Transfer the mold, compacted sample, and base plate, keeping the compacted side up, to the breaking head (modified 6-inch Lottman breaking head). Centre the plunger (1 ½-inch by 1 ½-inch cylinder) on top of the compacted specimen, and shear the flat end of the plunger into the compacted specimen using the Marshall Stability and Flow machine.

3.2 Terminate testing when a penetration of 0.25 inches (flow of 25) has been reached, or 10% of the sample height.

3.3 Record the peak shear resistance (CAR value) in pounds. For many 100% crushed fine aggregates, this will be the value at the time of termination (penetration of 0.25 in.).

Notes:

1. The influence of moisture absorption in this test procedure is mitigated if the components are mixed as soon as the 3.5% moisture has been added and then compacted immediately after mixing.
2. Using two pieces of non-absorptive specimen protection paper has been found to prevent the paper from sticking to the bottom of the compaction foot.
3. When compaction of the loose sample first occurs, collapse of air voids in the loose mix causes fine particles to be vented along with air from the collapsing air voids. The fine particles tend to adhere to a lubricated hammer shaft, and will cause drag on the sliding weight, which affects compactive effort. Tapping the sliding hammer on top of the compaction foot helps to collapse some of the air voids without forcefully ejecting aggregate particles.

It is recommended that the hammer shaft be cleaned and lubricated often.

Fines escaping from the edge of the specimen protection paper will adhere to the bottom of the compaction foot but are easily removed. Check the bottom of the compaction foot after each test specimen has been prepared.

4. When removing the protection paper, pry up one edge and slowly peel the paper backwards to prevent disturbing the compacted surface of the fine aggregate.
5. Use of a recording chart is recommended. The 5,000 lb setting works well for all materials. Some cubical limestone fine aggregates will exceed 5,000 lbs before reaching a penetration of 0.25 in. In these cases, record the CAR value as 5,000.

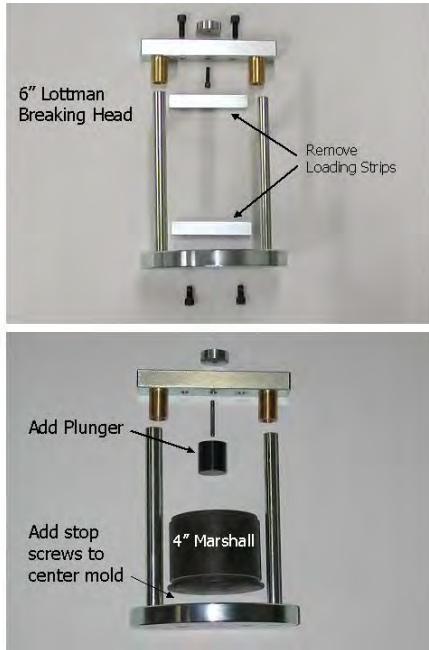

Compacted Aggregate Resistance (CAR) Test

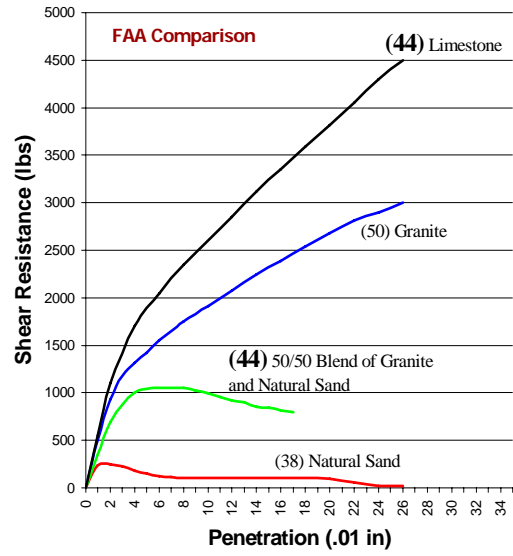

Limitation of the fine particles content in the aggregates for concrete

Girbes Clari, I., Marti Marti, P., Cuevas Castell, J.M., López Buendía, A.M.

AIDICO, Construction Technology Institute, Valencia Spain

Abstract

The goal of this study is the evaluation of the differential treatment imposed by the Standard EHE99 (Structural Concrete Instruction) regarding to the limitation of fine particles added by the fine fraction of the aggregates and fine particles added by the others concrete components. It is well known that the crushing processes to obtain sand particles with a certain grain size, implies an addition of considerable amount of fine particles. Moreover, the increasing of aggregate production and the environmental restriction to their exploitations make this study necessary in order to assure the demand of good quality aggregates.

Those fine particles may produce a conflict with the EHE standard which regulates the maximum fine particle content added by the incorporation of the aggregates for the concrete, independently of the mechanical properties of the concrete and the composition of the fine particles. It does not consider the additions in cement.

Furthermore, the general followed objectives for the fabrication of concrete are their performance for elaboration (workability), at short time behaviour (resistance) and long time (durability), as well as cost. From the point of view of aggregates, the alternative of a most economic concrete with good mechanical properties is the main goal. For those arguments, it has been considered in this study to estimate the real influence of the fine particles added by the aggregates on the mechanical properties of the concrete when the other components are maintained constant.

The study was carried out in different phases in order to evaluate, firstly, the influence of different fillers supplied by the fine fraction of the aggregates, and secondly, the influence of the quality and properties of each filler on the mechanical properties of the concretes. Finally, another interesting point for revision is the standard specifications regarding to the quality of the fillers due to this parameter play a determinant role on the mechanical properties and durability of the concretes. Moreover, according to the specification of the EHE standard, when the filler content not agree any of the requirements additional tests are required in order to corroborate the quality of the concrete.

The obtained results demonstrate that the influence of the fine particles introduced in the aggregates depend on the mineralogical composition of the fillers more than in the total amount. The resistance of the concretes is not compromised by the amount of fillers when the mineralogy assures a good adhesion to the cementing components. For this reasons the limitations of the standard should be revised in order to specify the quality of the fillers more than the quantity considering, at the same time, the amount of fillers supplied by the other components of the concrete. Finally, the results of the study have contributed to the actualization of the recent normative by been included into the new draft of the EHE07.

Limitation of the fine particles content in the aggregates for concrete

**Manufactured Aggregates WORKSHOP
STAVANGER 30 and 31 October 2008**

Girbes Clari, I., Marti Marti, P., Cuevas Castell, J.M., López Buendía, A.M.
AIDICO, Construction Technology Institute, Valencia Spain

AIDICO **IMPIVA**
RED IT

Limitation of the fine particles content in the aggregates for concrete

Introduction to the problem of the fine particles in aggregates

What are the main specifications for our study?:

Chapter 6, article 28: "The nature and preparation of aggregates will allow assuring the suitable resistance and durability of the concrete, as well as the other characteristics, which are demanded to the concrete in the particular technical specifications."



According to the normative, the **aggregates supplier must guarantee with documents** the fulfill of the technical specifications indicated in the section 28.3, "prescriptions and tests", until the reception of the aggregates. At this moment **the concrete manufacturer is obliged to use the aggregates** which are in compliance with the specifications. Additional tests could be demanded in case that the results are closed to the specifications.

Section 28.3.3. "Granulometry and shape of the aggregates", page 86: **"It is recommended that the resultant quantity of the particles from the fine aggregate which are able to pass the Sieve UNE 0.063 and the limestone component of the concrete was smaller than 175 kg/m3."**

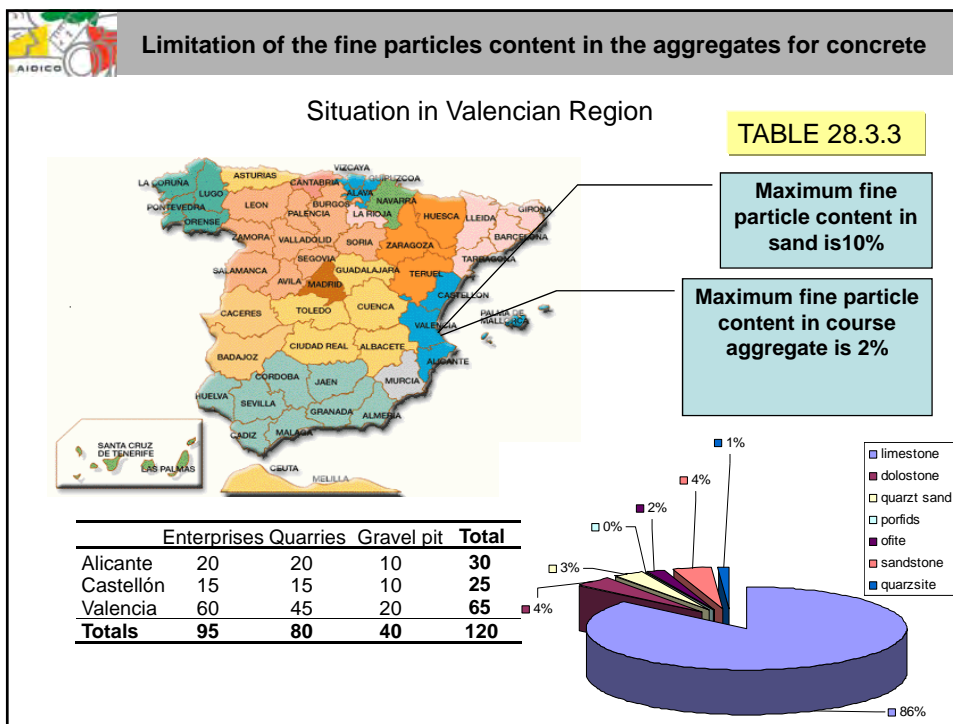

Limitation of the fine particles content in the aggregates for concrete

And some more technical specification of the Normative...

- Table 4.1.1. "Usual Concretes": The percentage of main and minority components is defined for each class and type of concrete. It is observed that **every type of concrete admit up to 5 % of minority components**, in most of the cases they are lime additions. Furthermore, the CEM II concretes admit in their compositions percentages of lime fillers between 6 % and 35 %.

Resuming:

There is not differences between the fine particles from the sand fraction and from the cements in the influence that both could play on the final product (concrete). This represent a incongruence with specifications marked by the EHE about the maximum admissible fine content in the sand fraction of the aggregate (10% in this case).

 **Limitation of the fine particles content in the aggregates for concrete**

General Objective:

To study the influence of the filler supplied by the fine fraction of aggregates from different origins on the mechanical properties of the concrete, as well as the its relationship with the total filler amount supplied by the other components of the concrete.

↓

To obtain a regional prescription document where the maxima and minima limits of filler contents are well established and defined according to the environments and specific used of the concrete.

Phase I “ Influence of different filler contents supplied by the fine fraction of the aggregates from multiple origins”

Phase II. “Influence of the filler content in concretes with low content in cement”

 **Limitation of the fine particles content in the aggregates for concrete**

METODOLOGY:

- Comparison of the initial and final properties (compression resistance, permeability and porosity) of the performed concretes:
 - Water/cement relationship constant.
 - Different filler percentages from 8 up to 20 %.
 - Aggregates from diverse sources and nature.
 - Experiment 1: limestone aggregates from gravel pit with low filler content in the fine fraction.
 - Experiment 2: Crushed limestone aggregates from quarry with high filler content in the fine fraction.

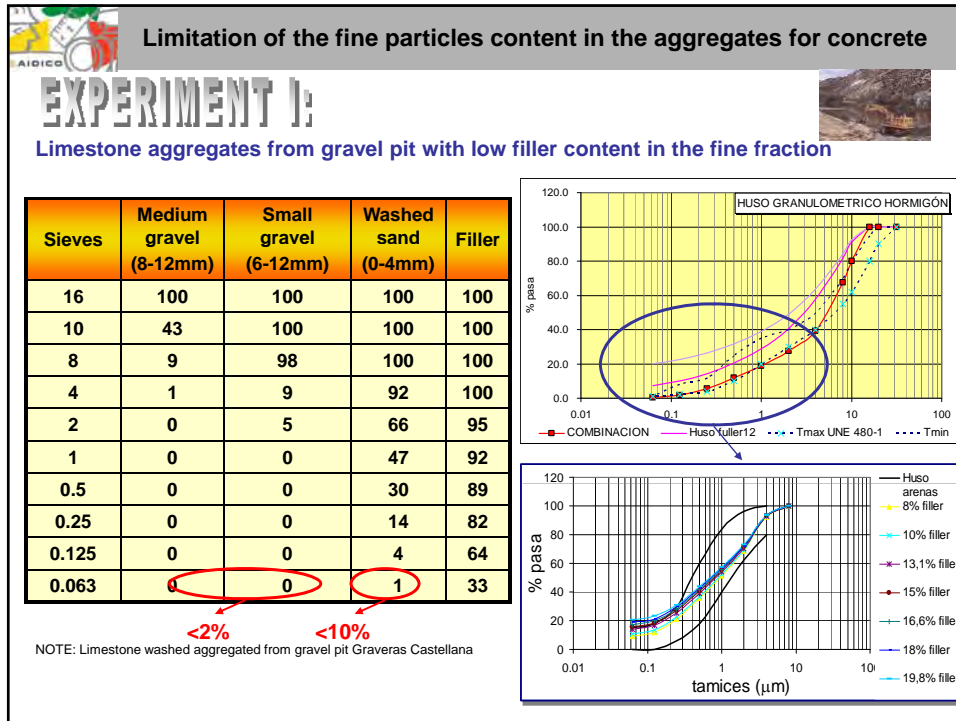

Limitation of the fine particles content in the aggregates for concrete

Physical-chemical characterization of the aggregates

	Medium gravel (8-12mm)	Small gravel (4-8mm)	Washed sand (0-4mm)	Filler
Real Density (g/cm3), dr	2.62	2.65	2.63	2.68
Real saturated density dry surface (gr/cm3), drss	2.64	2.68	2.64	
Shape coefficient	0.20	0.10 (l.lajas18)	-	
Water absorption coefficient (%), Ab	0.80	0.80	3.90	
Water content (%), h	2.50	3.70	6.70	
Determination of Sulfur content (% Stotal)			0.04	
Determination of chloride water-soluble(% Cl)			0.1	
Determination of organic compounds			+ light	
Sand equivalent (EV)			84	

Chemical characterization of the filler (%).

	SiO2	Al2O3	Fe2O3	CaO	MgO	K2O	Na2O	P2O5	MnO2	TiO2	SO3	P.F	TOC	Clays
Filler (1)	7.81	1.25	0.79	48.3	1.61	0.3	0.16	0.02	0.02	0.01	0.04	39.64	0.1	0.33

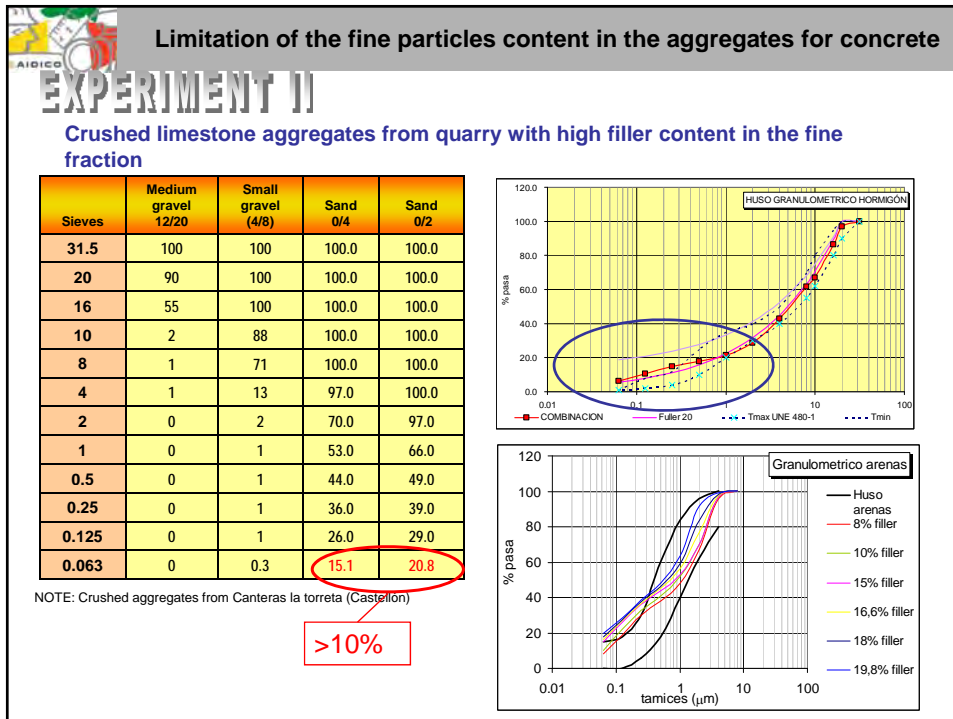
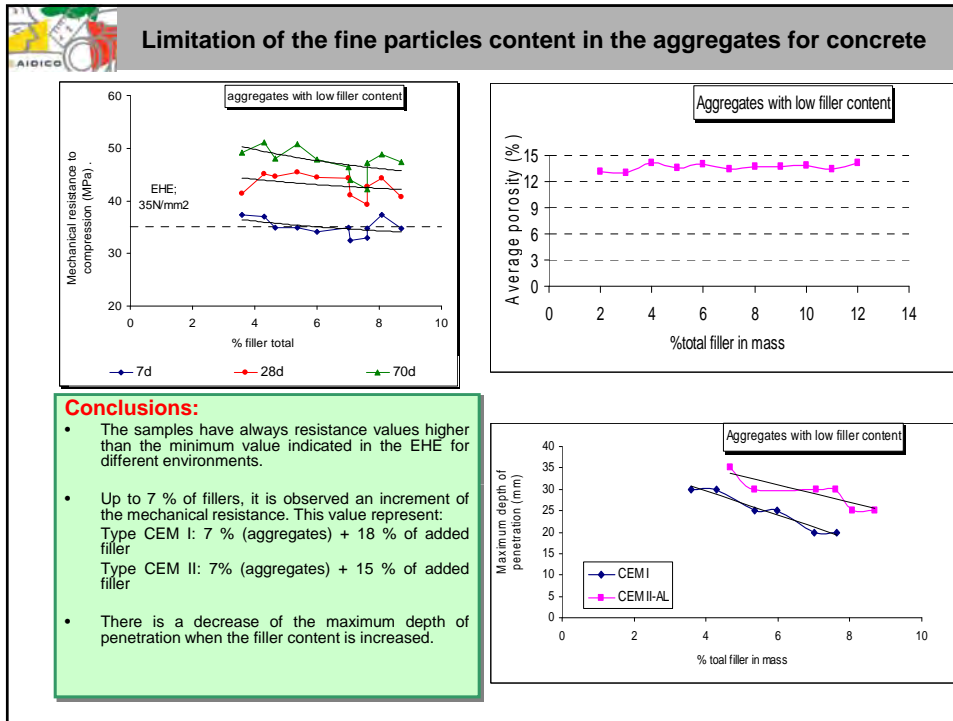

Limitation of the fine particles content in the aggregates for concrete

Physical-chemical characterization of the aggregates

	Medium gravel (12/20)	Small gravel (6/12)	Sand (0/4)	Sand (0/2)
Real Density (g/cm ³), dr	2.67	2.67	2.65	2.65
Real saturated density dry surface (gr/cm ³), drss				
Shape coefficient	0.24	0.16		
Índice de lajas	8	14	-	
Water absorption coefficient (%), Ab	0.80	1.2	2.1	2.1
Water content (%), h	0.5	0.4	1.8	
Determination of Sulfur content (% Stotal)			0.03	0.04
Determination of chloride water-soluble(% Cl)			0.01	0.01
Determination of organic compounds			+ light	+ light
Sand equivalent (EV)			69	66
Methylene blue			0.25	0.17

Chemical characterization of sands

	SiO ₂	Al ₂ O ₃	Fe ₂ O ₃	MnO	MgO	CaO	K ₂ O	Na ₂ O	P ₂ O ₅	TiO ₂	P.F
0/4	0.00	0.29	0.30	0.04	14.81	37.32	0.00	0.00	0.01	0.01	46.95
0/2	0.95	0.72	0.42	0.04	12.96	37.97	0.1	0.01	0.02	0.03	46.61

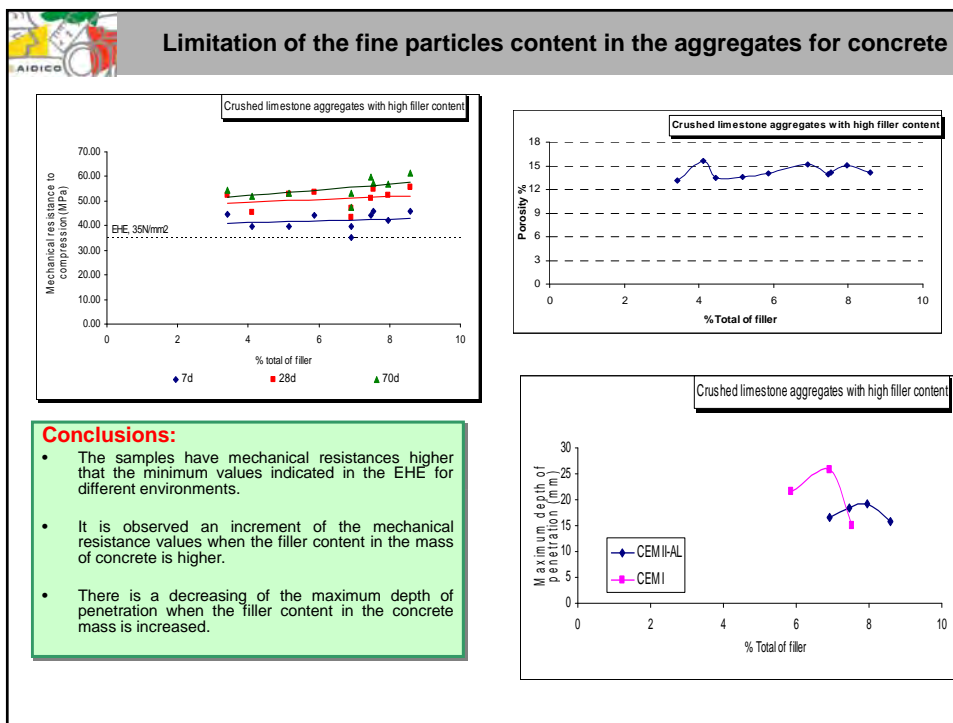



Limitation of the fine particles content in the aggregates for concrete

Conclusions and open questions for future works...

- The influence of the fine particles introduced in the aggregates depend on the mineralogical composition of the fillers more than in the total amount.
- The mechanical resistance of the concretes is not compromised by the amount of fillers when the mineralogy assures a good adhesion to the cementing components.
- For this reasons the limitations of the standard should be revised in order to specify the quality of the fillers more than the quantity considering, at the same time, the amount of fillers supplied by the other components of the concrete.



Limitation of the fine particles content in the aggregates for concrete

Conclusions and open questions for future works...

Open questions:

What happens when the fillers are mainly clays? What is up when the mineralogy of the fillers differs of the mineralogy of the aggregates? What is the behavior when the cement ratios are different?...

Future tasks:

- Perform a new experiment with a limestone aggregate with high content of clays as filler fraction.
- Analyze the filler of the aggregates to identify the different mineralogy and determinate the influence of the mineralogy of filler in the mechanical properties of the concretes.
- Evaluate the influence of fillers in concrete with low cement ratios

SINTEF Building and Infrastructure is the third largest building research institute in Europe. Our objective is to promote environmentally friendly, cost-effective products and solutions within the built environment. SINTEF Building and Infrastructure is Norway's leading provider of research-based knowledge to the construction sector. Through our activity in research and development, we have established a unique platform for disseminating knowledge throughout a large part of the construction industry.

COIN – Concrete Innovation Center is a Center for Research based Innovation (CRI) initiated by the Research Council of Norway. The vision of COIN is creation of more attractive concrete buildings and constructions. The primary goal is to fulfill this vision by bringing the development a major leap forward by long-term research in close alliances with the industry regarding advanced materials, efficient construction techniques and new design concepts combined with more environmentally friendly material production.

